



BUILDING TRUST



INSTALL DATA SHEET

Submerseal

Do not install this material until all members of your crew have read and understand these instructions. If you do not understand any part of these instructions CALL SIKA EMSEAL at 1-800-526-8365

IMPORTANT: Submerseal must be allowed to cure for 8-DAYS prior to contact with liquid. Please plan accordingly.

Installation Equipment & Material Storage

In addition to masonry tools needed to remove joint obstructions or adjust joint width as necessary the following are needed:

- Tape measure
- Heavy duty, plug-in, low speed, high torque drill
- Minimum 2 each 1 ½-inch diameter “jiffy mixers”
- Caulk gun(s) - 20-oz & 10.3-oz sealant provided
- Serrated edge knives (8-inch / 200mm or longer)
- Hacksaw
- Spray bottle filled with water
- Duct Tape (2 ½ times the length of joint)
- Spatula to scrape epoxy from can
- Chemical-resistant gloves
- 2-inch wide (50mm) margin trowels for applying epoxy adhesive on joint faces
- Caulk knives for tooling sealant bands
- Acetone for cleaning joint-faces, trowels and mixer tools
- Lint-free rags

Cold Days: Store material, off the floor, inside at above 68°F (20°C). It will recover slower when cold and faster when warm.

Very Hot Days: Keep material out of direct sun at temperatures greater than 60°F (15°C) until immediately prior to installation.

Long-Term Storage: Indirect heat can be applied to the material to increase expansion rate if not installed immediately after delivery.

DO NOT REMOVE OUTER PLASTIC PACKING UNTIL YOU READ THESE INSTRUCTIONS.

- Proper performance of expansion seals necessitate proper installation from beginning through completion.
- Improper handling will cause product to expand prematurely.

1. Prepare & Solvent-Wipe Joint Faces

Concrete:

- Remove loose particles and weak concrete to ensure sound concrete substrate. Spalls, chipped edges and uneven surfaces must be repaired using suitable patching material and proper patching geometry and techniques. Joint faces must be parallel.
- Joints must have unobstructed depth greater than or equal to the full depth of the largest material supplied plus 1/2-inch (6mm).
- Remove all contaminants by sandblasting or grinding to ensure a thoroughly clean and sound substrate for the full sealant depth.

NOTE: DO NOT use a wire wheel--this will polish the substrate and cause bond-failure.

- Dry all wet surfaces.

NOTE: Do not use flame to dry substrate--this will leave carbon on the substrate and cause bond-failure.

- Wipe joint faces with solvent-dampened, lint-free rags to remove all concrete dust and contaminants.

Metal:

- Sandblast or grind to rough, white metal and solvent-wipe immediately.

IMPORTANT: Ensure that no oxidation (rusting) occurs before the epoxy is applied.

Other Substrates: [Contact Sika Emseal](#)

2. Mask Deck and Mix Epoxy Adhesive

- Tape off the deck on both sides of the joint.

Mix Epoxy:

Epoxy adhesive may be used in the 40°F (5°C) to 95°F (35°C) temperature range.

- Using a trowel, transfer the entire contents of Part B (hardener) into the contents of Part A (base).
- Mix the material thoroughly (3 minutes) with a drill and mixing paddle. Scrape the walls and bottom of the container to ensure uniform and complete mixing.
- Always mix component B (hardener) into component A (base). Ensure that a uniform gray color with no black or white streaks is obtained.

IMPORTANT: DO NOT thin the epoxy.

Precaution: Wear chemical-resistant gloves and/or barrier hand cream when handling liquid sealant or epoxy. Remove promptly from skin with a commercial hand cleaner before eating or smoking. Avoid inhaling vapors.

3. Apply Epoxy to Substrate Walls

- Ensure that the mixed epoxy adhesive is applied to both substrate walls before the pot life has expired (10 – 30 minutes depending on the ambient temperature).

WARNING – Epoxy will harden more quickly when left in the pot. Apply it onto the joint faces as soon as possible.

IMPORTANT: The epoxy must still be uncured when installing foam into the joint-gap.

- If the epoxy cures before installing the Submerseal foam then reapply new epoxy. If work is interrupted for more than 2 hours after initial cure then grind the old epoxy and apply new wet epoxy.

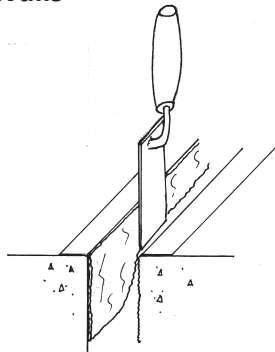

4. Open Plastic Packaging

- Slit the plastic packing by cutting on the hardboard and remove hardboard and inner release liner. DO NOT cut along the sealant bellows.

IMPORTANT: Work quickly and deliberately after cutting the shrink-wrap to avoid material expanding beyond a usable size.

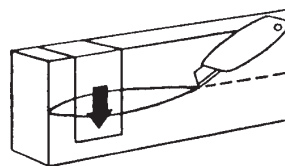

5. Wipe Release Agent Off Sealant Facing

- For packaging and production reasons, the sealant facing is coated in the factory with a release agent.
- Prior to installation, this agent must be wiped off using a damp rag in order for the injected sealants bands described in Step 10 to adhere to the sealant facing and to avoid contamination of the substrate at this point.
- Lightly, quickly and thoroughly wipe the cured sealant facing with a lint-free rag made damp with water.

6. Install Submerseal Foam & Apply Sealant

- When installing the foam into the joint, ensure that the epoxy on the joint face has not cured.
- When installed, the Submerseal must be recessed so that the top of the bellows is recessed 1/4-inch below the deck surface.

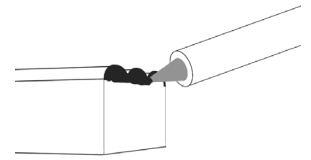

NOTE – When material is correctly expanded for a snug fit it will support its own weight in the joint.

- Feed material into joint, starting from one end. The material should fit snugly and must be eased into the joint with steady, firm pressure.

7. Install Next Length. Repeat

- Work in one direction towards the previously installed length or end of joint. Do not stretch material.
- Leave the end to be joined to the previous length sticking proud of the joint--push the joining faces together.
- Push Hard on the length to compress joints firmly together. Ensure there are no voids at joins.
- Once the full length is installed, push the protruding joint into the joint and tool off the excess sealant.
- During low temperature installation, provide as much ambient heat as possible around installed Submerseal foam to accelerate recovery.



8. Inject Sealant Bands & Tool Excess Sealant

- Wipe any excess epoxy from top of material using a clean rag.
- Before the epoxy cures, force the tip of the sealant nozzle between the substrate and the foam. Inject a 3/4-inch (20mm) deep sealant band between the foam, cured sealant facing and the joint-face.
- Tool the applied sealant firmly to blend with the substrates and cured bellow facing, and to ensure a proper bond and seamless appearance.
- Where the foam meets at butt joints, tool the excess sealant that squeezes out from the top and between the bellows.

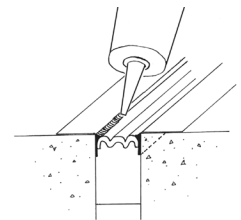

IMPORTANT: 8-DAY CURE TIME

Allow liquid silicone to attain a complete cure before filling area with liquid (**8 days minimum**). Note: if the silicone at joints, sealant bands and corner beads is not allowed to fully cure, the system will not be capable of resisting hydrostatic pressure.

NOTE: Do not install Submerseal into the base setting bed of any tile finish, or against tile or grout.

Transitions, Ends, and Special Conditions

Sequencing – Install factory-fabricated transition and/or termination pieces FIRST. Connect straight run material to in-place terminations and transitions. Apply the joining sealant (at the bellows ends only) on the straight length before inserting it into the joint (see step #8). Bring the joint firmly against the butt end of the already installed factory-fabricated transition and push the straight run stick towards this joint throughout the process of installing it.

Note – If installing very long runs of material, to avoid having to work at distant ends of a joint run and in order to prevent epoxy from fully curing, the final factory-fabricated 90 termination can be installed as the second-to-last piece.

Cut closing pieces 3/8-inch (10mm) longer than the opening to be joined. Compress material longitudinally to fit.

Custom-90 Transitions

Custom-90's are designed to continue the Submerseal through changes in plane such as at floor-to-walls, curbs, treads or other such changes in slab thickness. Install [factory-fabricated transition](#) and/or termination pieces first. Custom-90's may also be used to transition to another Emseal foam product.

Connect straight run material to in-place terminations and transitions (see step #7). Cut closing pieces 3/8-inch (10mm) longer than the opening to be joined. Compress material longitudinally to fit.

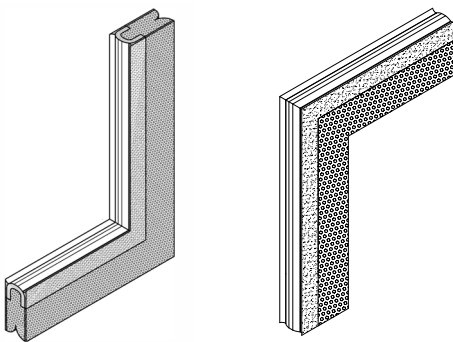

Flat Corners:

- Work towards the corner so that the last two pieces to install will join at the corner.
- Cut each piece to be joined 3/8-inch (10 mm) longer than needed.
- Install one piece so that it runs through the intersecting joint-gap. Firmly push and compress the extra length so that a tight fit in the corner is achieved.
- Firmly butt intersecting pieces into sides of already placed material.

****IMPORTANT:** Be sure that there is no epoxy on the sides or faces of foam at a butt join.

- Using a caulk knife, remove any excess sealant and blend the liquid sealant into the bellows to preserve the bellow shape. **NOTE** – The extra length will make it a tight fit — this results in a compression fit.
- Inject a bead of liquid sealant where the sealant faces join and where the sealant faces meet the substrate.

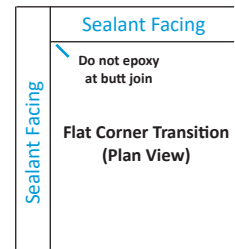

Crosses And Tees:

- Run one piece of material across the intersection. Coat sealant bellows end (only) of the intersecting material with sealant. Firmly butt intersecting pieces into sides of already placed material.
- Using a caulk knife, remove any excess sealant and blend the liquid sealant into the bellows to preserve the bellows shape.

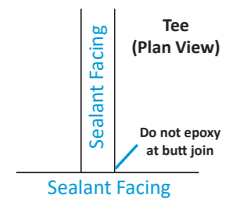
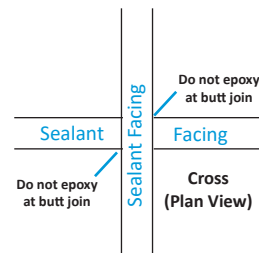

Sealant-Coat Any Exposed Foam Ends:

IMPORTANT: If the Submerseal runs are not part of a closed loop system, and Custom-90 terminations are not used (run does not terminate in an upturn or downturn), lightly coat any exposed foam ends using the liquid sealant provided. This is critical in ensuring that the watertightness of the foam is sealed.

EMSEAL JOINT SYSTEMS, LTD
25 Bridle Lane
Westborough, MA 01581 USA
Phone: 508.836.0280
Fax: 508.836.0281
www.emseal.com

EMSEAL, LLC
111 Royal Group Crescent
Woodbridge, ON L4H 1X9 Canada
Phone: +1-416-740-2090
Fax: +1-416-740-0233
www.emseal.com

SIKA CORPORATION
201 Polito Avenue
Lyndhurst, NJ 07071 USA
Phone: +1-800-933-7452
Fax: +1-2019336225
www.usa.sika.com

Install Data Sheet
Sika Emseal Submerseal
July 2024 Version SE-1.0



BUILDING TRUST

