

REVEALS + MOLDINGS

# FRY REGLET

REVEALS + MOLDINGS PRODUCT BROCHURE





## CONTENTS

**D** Drywall Reveals & Moldings











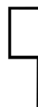





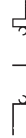

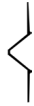

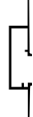
<b>DA</b> REVEALS	<b>DA.1</b>	Reveal	<b>DD</b> CORNERS	<b>DD.1</b>	Stepped Outside Corner / Drywall Corner Reveal				
	<b>DA.2</b>	"F" Reveal		<b>DD.2</b>	Multiple Stepped Outside Corner				
	<b>DA.3</b>	"Snap-In" Reveal		<b>DD.3</b>	Beveled Corner				
	<b>DA.4</b>	Base		<b>DD.4</b>	Curved Inside Corner				
	<b>DA.5</b>	Field		<b>DD.5</b>	Curved Outside Corner				
	<b>DA.6</b>	Outside Corner		<b>DA.6</b>	Bullnose				
	<b>DA.7</b>	"Z" Reveal		<b>DE</b> COLUMN COLLARS + RINGS	<b>DE.1</b>	Column Collar			
	<b>DA.8</b>	Reveal Base			<b>DE.2</b>	Reveal Column Ring			
	<b>DA.9</b>	Flush Base Reveal			<b>DE.3</b>	Wall Angle Column Ring			
	<b>DA.10</b>	Flush Base			<b>DF</b> ACOUSTICAL	<b>DF.1</b>	"W" Reveal Molding		
	<b>DA.11</b>	Step Trim				<b>DF.2</b>	Drywall/Acoustical Reveal		
	<b>DA.12</b>	"V" Reveal				<b>DF.3</b>	Acoustical Ceiling Trim		
	<b>DA.13</b>	Reverse "V" Reveal				<b>DF.4</b>	Acoustical Molding		
	<b>DA.14</b>	"W" Reveal				<b>DF.5</b>	"W" Acoustical Reveal		
	<b>DA.15</b>	Reveal/Picture Hanger				<b>DF.6</b>	"F" Acoustical Reveal		
	<b>DA.16</b>	Reveal Channel Screed/Plaster and Stucco Control Joint				<b>DF.7</b>	"J" Acoustical Trim		
	<b>DA.17</b>	"F" Reveal		<b>DG</b> SPECIAL SECTIONS		<b>DG.1</b>	Special Sections		
	<b>DA.18</b>	"T" Molding				<b>DG.2</b>	Contemporary Reveal		
	<b>DA.19</b>	"X" Molding				<b>DH</b> GLAZING TRACK	<b>DH.1</b>	Glazing Track / Drywall Ceiling Track	
	<b>DA.20</b>	"W" Molding			<b>DH.2</b>		Acoustical Ceiling Tract / Drywall Acoustical Ceiling		
<b>DB</b> EXPANSION JOINTS	<b>DB.1</b>	Drywall Expansion Joint	<b>DI</b> INTEGRATED FUNCTION REVEAL		<b>DI.1</b>		Reveal Rail Chartrail Insert Hook Insert		
	<b>DC</b> TRIMS	<b>DC.1</b>			Corner Trim		<b>DJ</b> INSTALLATION	<b>DJ.1</b>	Installation Guide
		<b>DC.2</b>			"L" Trim Molding			<b>DJ.2</b>	Installation Guide
		<b>DC.3</b>			Edge Trim			<b>DJ.3</b>	Installation Guide
		<b>DC.4</b>			Edge Trim			<b>DJ.4</b>	Venting Information
		<b>DC.5</b>			Radius Corner Trim				
		<b>DC.6</b>		Pocket Trim					
		<b>DC.7</b>		"J" Molding					
		<b>DC.8</b>		Drywall Molding End Closure					
		<b>DC.9</b>		Top Track					
		<b>DC.10</b>		Ceiling Trim					
		<b>DC.11</b>		Protruding Edge					
		<b>DC.12</b>		30° / 45° Angle Trim					
<b>DC.13</b>		Wall Angle							

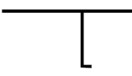
## SHAPE FINDER INDEX

### D Drywall Moldings













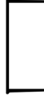

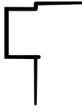







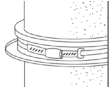
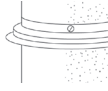
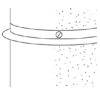

#### GUIDE SPECIFICATION

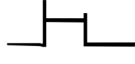
Where indicated on drawings, Fry Reglet reveals and moldings, as manufactured by Fry Reglet Corporation, shall be installed. Fry Reglet aluminum reveals and moldings shall be extruded alloy 6063 T5, with chemical conversion coating, primed finish, clear anodized or other specified finish. Refer to finish section.

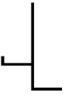
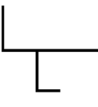
<b>DA.1</b> REVEAL 	<b>DA.2</b> "F" REVEAL 	<b>DA.3</b> "SNAP-IN" REVEAL 	<b>DA.4</b> BASE 	<b>DA.5</b> FIELD 
<b>DA.6</b> OUTSIDE CORNER 	<b>DA.7</b> "Z" REVEAL 	<b>DA.8</b> REVEAL BASE 	<b>DA.9</b> FLUSH BASE REVEAL 	<b>DA.10</b> FLUSH BASE 
<b>DA.11</b> STEP TRIM 	<b>DA.12</b> "V" REVEAL 	<b>DA.13</b> REVERSE "V" REVEAL 	<b>DA.14</b> "W" REVEAL 	<b>DA.15</b> REVEAL/ PICTURE HANGER 
<b>DA.16</b> REVEAL CHANNEL SCREED/ PLASTER AND STUCCO CONTROL JOINT 	<b>DA.17</b> "F" REVEAL 	<b>DA.18</b> "T" MOLDING 	<b>DA.19</b> "X" MOLDING 	<b>DA.20</b> "W" MOLDING 
<b>DB.1</b> DRYWALL EXPANSION JOINT 	<b>DC.1</b> CORNER TRIM 	<b>DC.2</b> "L" TRIM MOLDING 	<b>DC.3</b> EDGE TRIM 	<b>DC.4</b> EDGE TRIM 

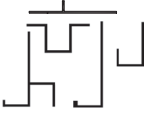
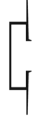
SHAPE FINDER INDEX

D Drywall Moldings

<p><b>DC.5</b></p> <p>RADIUS CORNER TRIM</p> 	<p><b>DC.6</b></p> <p>POCKET TRIM</p> 	<p><b>DC.7</b></p> <p>"J" MOLDING</p> 	<p><b>DC.8</b></p> <p>DRYWALL MOLDING END CLOSURE</p> 	<p><b>DC.9</b></p> <p>TOP TRACK</p> 
<p><b>DC.10</b></p> <p>CEILING TRIM</p> 	<p><b>DC.11</b></p> <p>PROTRUDING EDGE</p> 	<p><b>DC.12</b></p> <p>30° / 45° ANGLE TRIM</p> 	<p><b>DC.13</b></p> <p>WALL ANGLE TRIM</p> 	<p><b>DD.1</b></p> <p>STEPPED OUTSIDE CORNER</p> 
<p><b>DD.2</b></p> <p>BEVELED CORNER</p> 	<p><b>DD.3</b></p> <p>MULTIPLE STEPPED OUTSIDE CORNER</p> 	<p><b>DD.4</b></p> <p>CURVED INSIDE CORNER</p> 	<p><b>DD.5</b></p> <p>CURVED OUTSIDE CORNER</p> 	<p><b>DD.6</b></p> <p>BULLNOSE</p> 
<p><b>DE.1</b></p> <p>COLUMN COLLAR</p> 	<p><b>DE.2</b></p> <p>REVEAL COLUMN RING</p> 	<p><b>DE.3</b></p> <p>WALL ANGLE COLUMN RING</p> 	<p><b>DF.1</b></p> <p>"W" REVEAL MOLDING</p> 	<p><b>DF.2</b></p> <p>DRYWALL - ACOUSTICAL REVEAL</p> 
<p><b>DF.3</b></p> <p>ACOUSTICAL CEILING TRIM</p> 	<p><b>DF.4</b></p> <p>ACOUSTICAL MOLDING</p> 	<p><b>DF.5</b></p> <p>"W" ACOUSTICAL REVEAL</p> 	<p><b>DF.6</b></p> <p>"F" ACOUSTICAL REVEAL</p> 	<p><b>DF.7</b></p> <p>"E" ACOUSTICAL TRIM</p> 
<p><b>DG.1</b></p> <p>"F" ACOUSTICAL REVEAL</p> 	<p><b>DG.2</b></p> <p>"F" ACOUSTICAL TRIM</p> 	<p><b>DH.1</b></p> <p>GLAZING TRACK</p> 	<p><b>DH.2</b></p> <p>ACOUSTICAL CEILING TRACK</p> 	<p><b>DI.1</b></p> <p>INTEGRATED FUNCTION REVEAL</p> 

**DA.1**

**PRODUCT DETAIL**

**INSTALLATION DETAIL / Cross Section**

**REVEAL**

DIM. A REVEAL DEPTH	DIM. B REVEAL WIDTH	NUMBER	
		NON-VENTED	VENTED
1/4"	1/4"	DRM-25-25	--
1/2"	1/8"	DRM-50-125	--
1/2"	1/4"	DRM-50-25	--
1/2"	3/8"	DRM-50-375	--
1/2"	1/2"	DRM-50-50	DRM-50-V-50
1/2"	5/8"	DRM-50-625	DRM-50-V-625
1/2"	3/4"	DRM-50-75	DRM-50-V-75
1/2"	1"	DRM-50-100	DRM-50-V-100
1/2"	1 1/2"	DRM-50-150	DRM-50-V-150
1/2"	2"	DRM-50-200	DRM-50-V-200
1/2"	2 1/2"	DRM-50-250	DRM-50-V-250
1/2"	3"	DRM-50-300	DRM-50-V-300
1/2"	4"	DRM-50-400	DRM-50-V-400
5/8"	1/4"	DRM-625-25	--
5/8"	3/8"	DRM-625-375	--
5/8"	1/2"	DRM-625-50	DRM-625-V-50
5/8"	5/8"	DRM-625-625	DRM-625-V-625
5/8"	3/4"	DRM-625-75	DRM-625-V-75
5/8"	1"	DRM-625-100	DRM-625-V-100
5/8"	1 1/4"	DRM-625-1250	DRM-625-V-1250
5/8"	1 1/2"	DRM-625-150	DRM-625-V-150
5/8"	2"	DRM-625-200	DRM-625-V-200
5/8"	2 1/2"	DRM-625-250	DRM-625-V-250
5/8"	3"	DRM-625-300	DRM-625-V-300
5/8"	4"	DRM-625-400	DRM-625-V-400
5/8"	6"	DRM-625-600	DRM-625-V-600

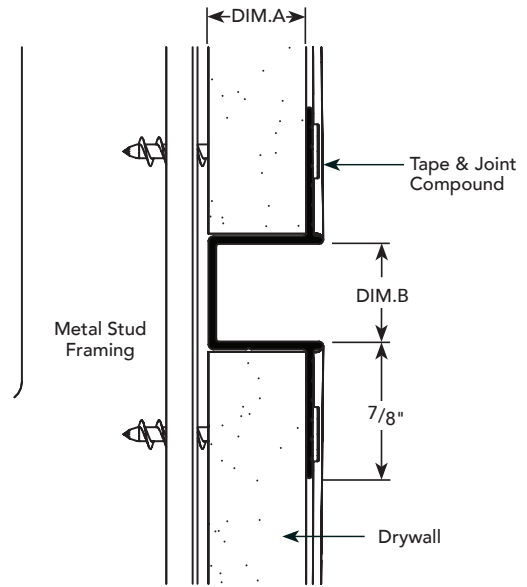

**DA.2** PRODUCT DETAIL

**"F" REVEAL**

DIM. A REVEAL DEPTH	DIM. B REVEAL WIDTH	NUMBER	
		NON-VENTED	VENTED
1/2"	1/8"	DRMF-50-125	--
1/2"	1/4"	DRMF-50-25	--
1/2"	3/8"	DRMF-50-375	--
1/2"	1/2"	DRMF-50-50	DRMF-50-V-50
1/2"	5/8"	DRMF-50-625	DRMF-50-V-625
1/2"	3/4"	DRMF-50-75	DRMF-50-V-75
1/2"	1"	DRMF-50-100	DRMF-50-V-100
5/8"	3/8"	DRMF-625-375	--
5/8"	1/2"	DRMF-625-50	DRMF-625-V-50
5/8"	5/8"	DRMF-625-625	DRMF-625-V-625
5/8"	3/4"	DRMF-625-75	DRMF-625-V-75
5/8"	1"	DRMF-625-100	DRMF-625-V-100
5/8"	1 1/2"	DRMF-625-150	DRMF-625-V-150
5/8"	2"	DRMF-625-200	DRMF-625-V-200
5/8"	3"	DRMF-625-300	DRMF-625-V-300

INSTALLATION DETAIL / Cross Section

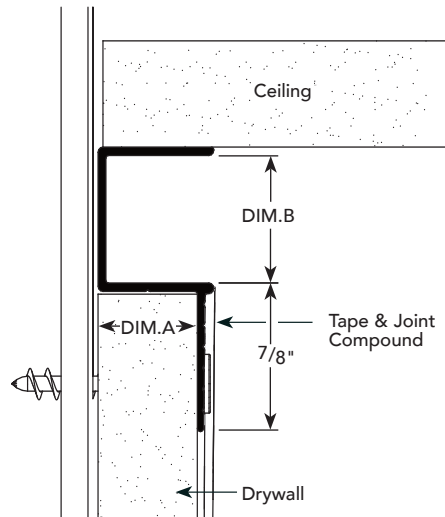

**DA.3** PRODUCT DETAIL

**"SNAP-IN" REVEAL**

DIM. A REVEAL WIDTH	NUMBER
3/8"*	DRM-SNAP-IN-375
1/2>**	DRM-SNAP-IN-50
5/8***	DRM-SNAP-IN-625

\*Snap-In fits following profiles:  
DRM-50-50, DRM-625-50, DRMF-50-50, DRMF-625-50  
 \*\*Snap-In fits following profiles:  
DRM-50-625, DRM-625-625, DRMF-50-625, DRMF-625-625  
 \*\*\*Snap-In fits following profiles:  
DRM-50-75, DRM-625-75, DRMF-50-75, DRMF-625-75

INSTALLATION DETAIL / Cross Section

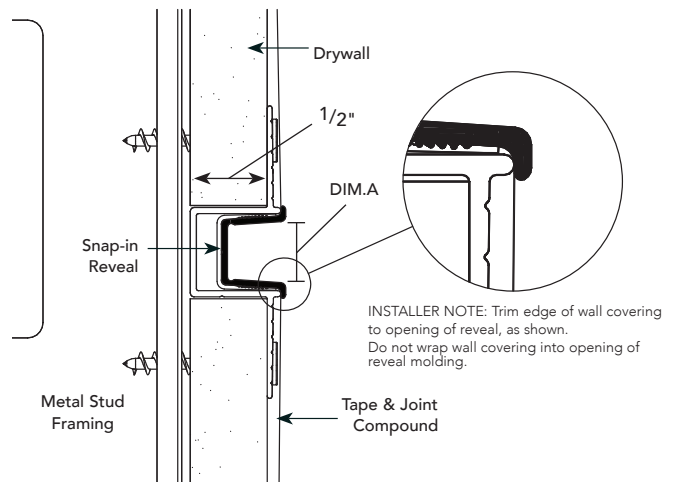

**DA.4** PRODUCT DETAIL

WALL COVERING TRIMS

**WCTBT125-217**  
(BASE & TERMINATION)

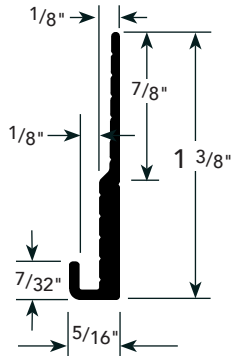

INSTALLATION DETAIL / Cross Section

**WCTBT125-217**

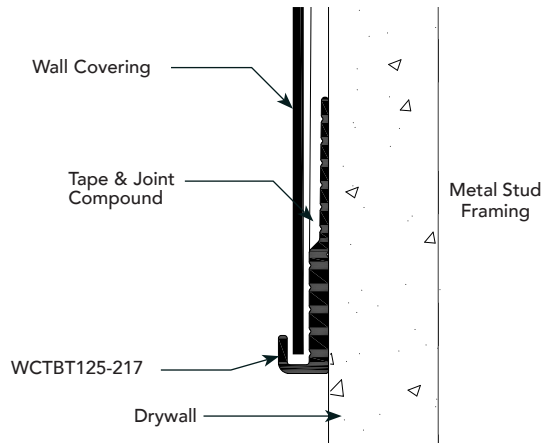

**DA.5** PRODUCT DETAIL

**WCTF125-217**  
(FIELD)

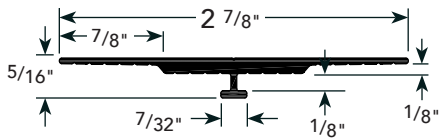

INSTALLATION DETAIL / Cross Section

**WCTF125-217**

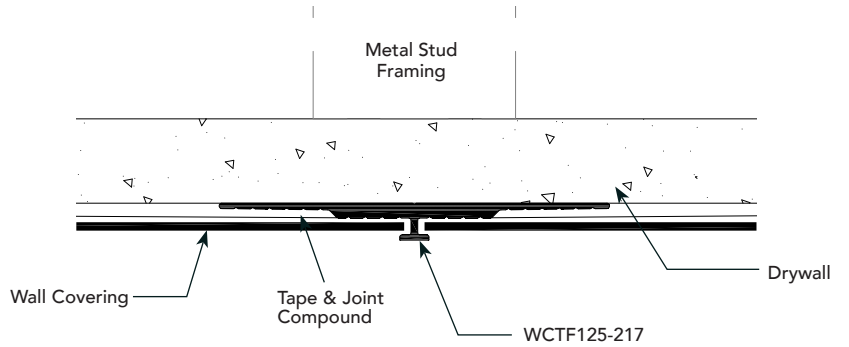

**DA.6** PRODUCT DETAIL

**WCTOSC**  
(OUTSIDE CORNER)

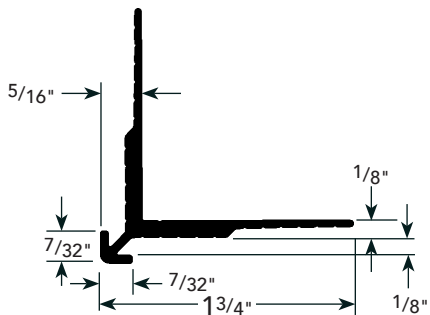

INSTALLATION DETAIL / Cross Section

**WCTOSC**

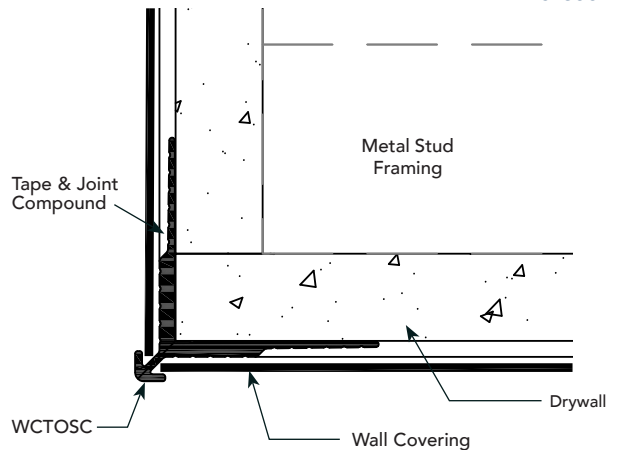



**DA.7** PRODUCT DETAIL

**"Z" REVEAL**

DIM. A REVEAL DEPTH	DIM. B REVEAL WIDTH	NUMBER	
		NON-VENTED	VENTED
1/4"	1/4"	DRMZ-25-25	--
1/2"	1/8"	DRMZ-50-125	--
1/2"	1/4"	DRMZ-50-25	--
1/2"	3/8"	DRMZ-50-375	--
1/2"	1/2"	DRMZ-50-50	DRMZ-50-V-50
1/2"	5/8"	DRMZ-50-625	DRMZ-50-V-625
1/2"	3/4"	DRMZ-50-75	DRMZ-50-V-75
1/2"	1"	DRMZ-50-100	DRMZ-50-V-100
1/2"	1 1/2"	DRMZ-50-150	DRMZ-50-V-150
1/2"	2"	DRMZ-50-200	DRMZ-50-V-200
5/8"	1/4"	DRMZ-625-25	--
5/8"	3/8"	DRMZ-625-375	--
5/8"	1/2"	DRMZ-625-50	DRMZ-625-V-50
5/8"	5/8"	DRMZ-625-625	DRMZ-625-V-625
5/8"	3/4"	DRMZ-625-75	DRMZ-625-V-75
5/8"	1"	DRMZ-625-100	DRMZ-625-V-100
5/8"	1 1/4"	DRMZ-625-1250	DRMZ-625-V-1250
5/8"	2"	DRMZ-625-200	DRMZ-625-V-200
1"	1"	DRMZ-100-100	DRMZ-100-V-100

INSTALLATION DETAIL / Cross Section

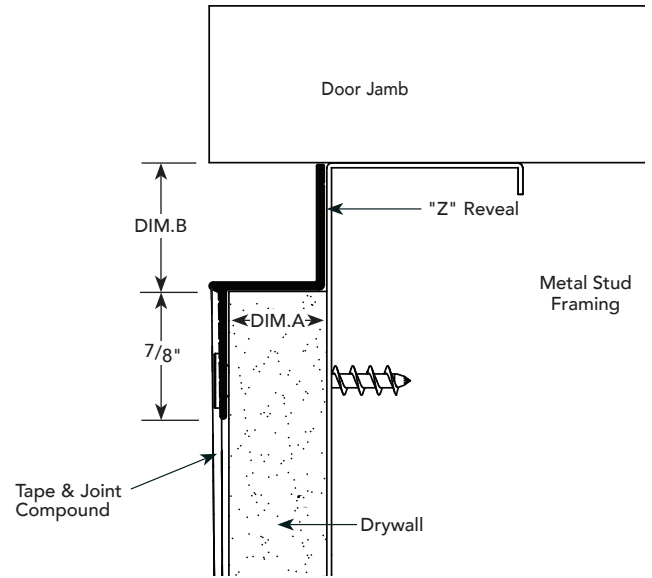

**DA.8** PRODUCT DETAIL

**REVEAL BASE**

DIM. A REVEAL DEPTH	DIM. B REVEAL HEIGHT	NUMBER
1/2"	4"	DRMB-50-400
5/8"	2 1/2"	DRMB-625-250
5/8"	3"	DRMB-625-300
5/8"	4"	DRMB-625-400
5/8"	6"	DRMB-625-600

INSTALLATION DETAIL / Cross Section

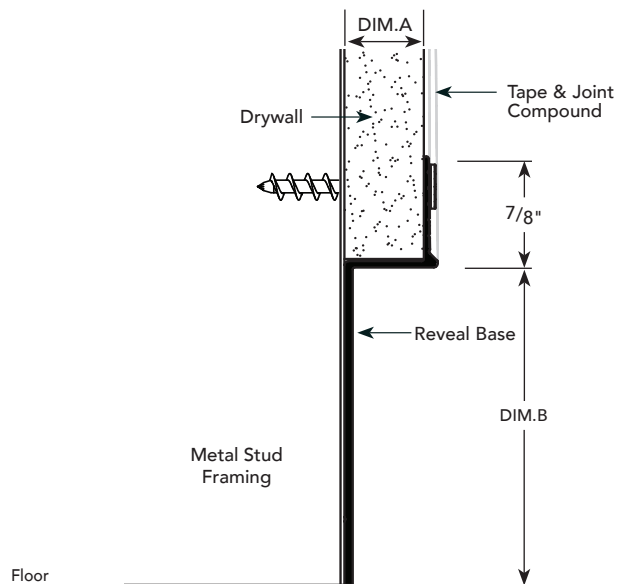

**DA.9** PRODUCT DETAIL

INSTALLATION DETAIL / Cross Section

**FLUSH BASE REVEAL**

DIM. A REVEAL DEPTH	DIM. B REVEAL WIDTH	NUMBER
1/2"	1/4"	DRMBFLR5025400
1/2"	1/2"	DRMBFLR5050400
5/8"	1/4"	DRMBFLR62525400
5/8"	1/2"	DRMBFLR62550400

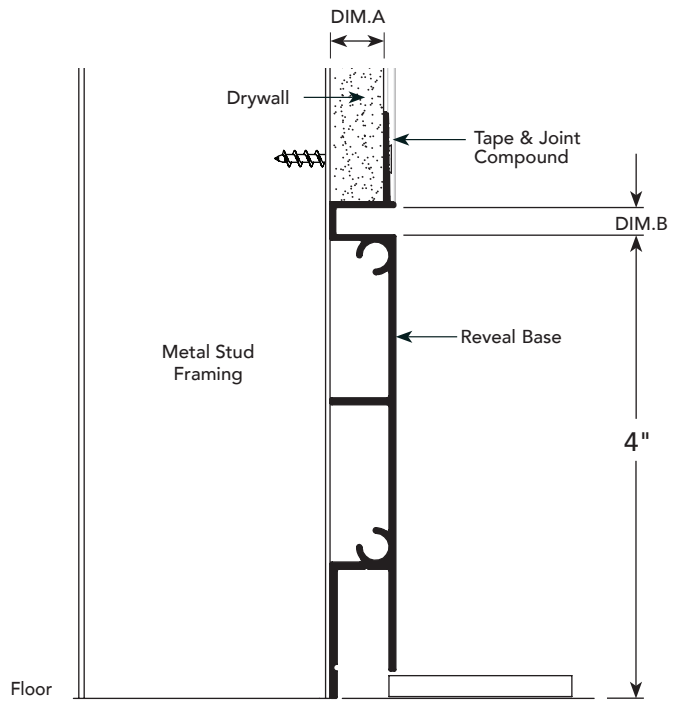

**DA.11** PRODUCT DETAIL

INSTALLATION DETAIL / Cross Section

**STEP TRIM**

DIM. A STEP SIZE	NUMBER
1/2"	DMST-50-50
5/8"	DMST-625-625

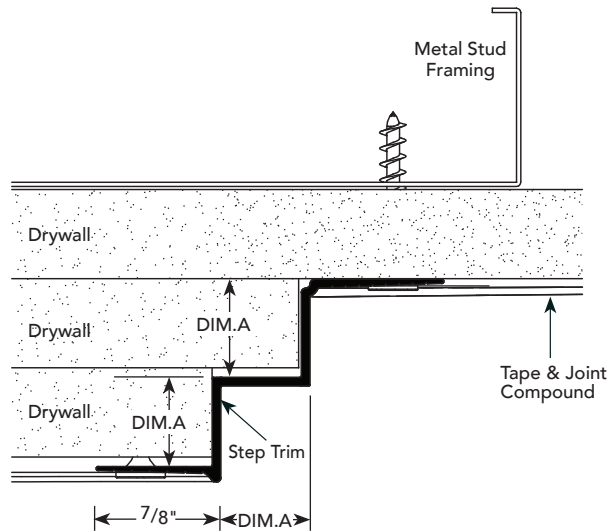

**DA.10 PRODUCT DETAIL**

**FLUSH BASE**

DIM. A REVEAL DEPTH	NUMBER
1/2"	DRMBFL50400
5/8"	DRMBFL625400

**INSTALLATION DETAIL / Cross Section**

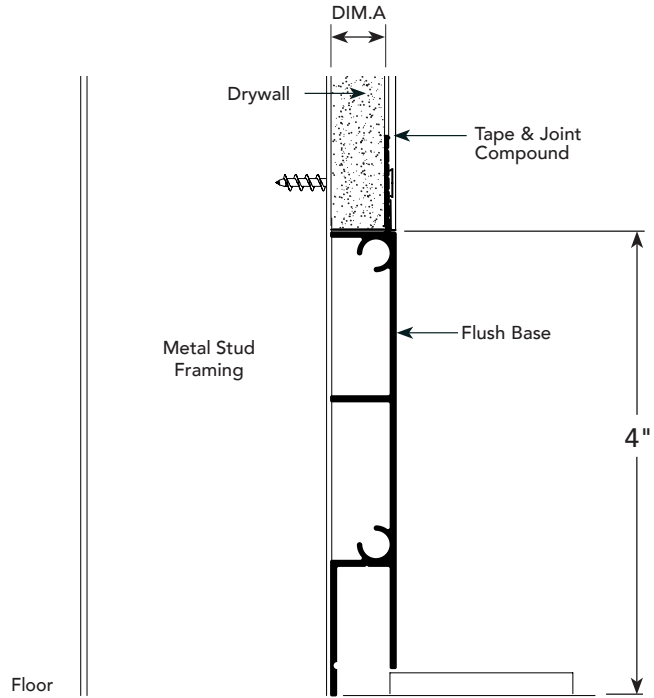

**DA.12 PRODUCT DETAIL**

**REVERSE "V" REVEAL MOLDING**

REVEAL WIDTH	NUMBER
1"	DRMVR-100

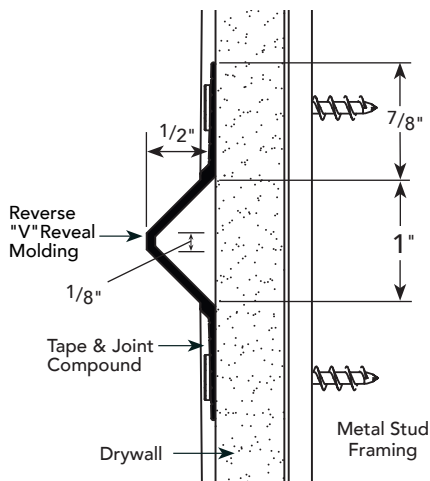

**DA.13 PRODUCT DETAIL**

**"V" REVEAL**

DIM. A REVEAL WIDTH	DIM. B REVEAL DEPTH	NUMBER
1/4"	1/4"	DRMV-25
3/4"	1/2"	DRMV-75
1"	1/2"	DRMV-100

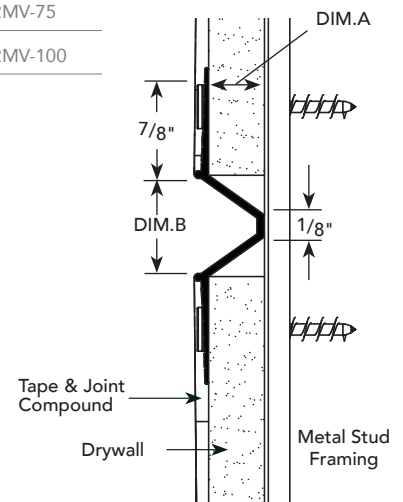

**DA.14**

**PRODUCT DETAIL**

**INSTALLATION DETAIL / Cross Section**

**"W" REVEAL**

DIM. A REVEAL DEPTH	DIM. B REVEAL WIDTH	NUMBER
1/2"	1/2"	DRWT-50-50
3/4"	3/4"	DRWT-75-75
2"	2"	DRWT-200-200

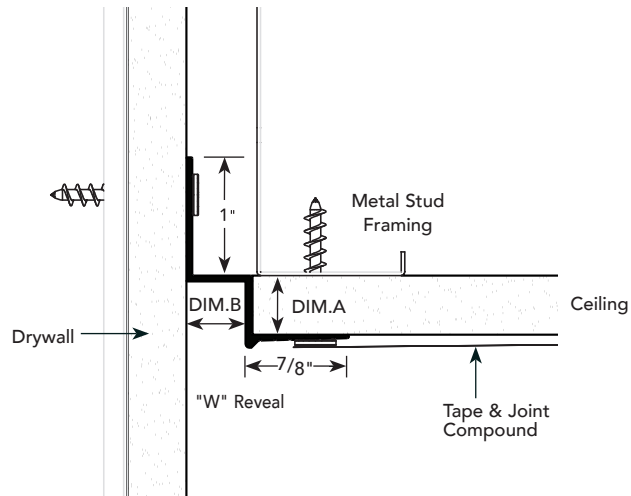

**DA.15**

**PRODUCT DETAIL**

**INSTALLATION DETAIL / Cross Section**

**REVEAL/  
PICTURE  
HANGER**

REVEAL WIDTH	NUMBER
3/4"	DRMH-50

\*Hanger clips (DRMH-50 insert) sold separately.  
 Note: Maximum capacity per hanger clip is 75 pounds.  
 Not to exceed 4 clips per 10ft. peice

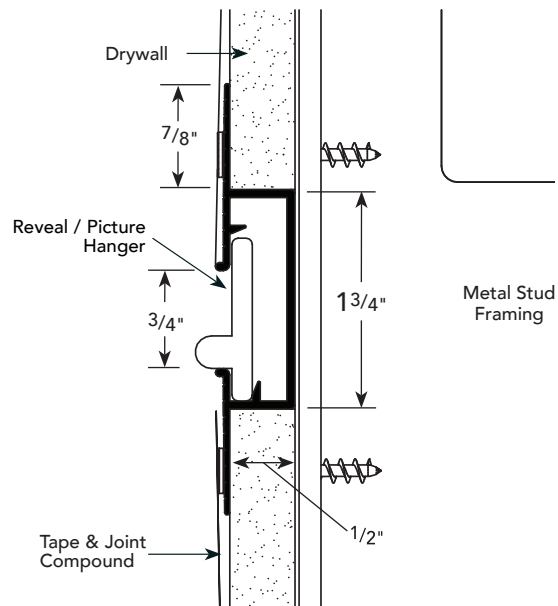

**DA.16**

**PRODUCT DETAIL**

**REVEAL CHANNEL  
SCREED/PLASTER  
AND STUCCO  
CONTROL JOINT**

DIM. A REVEAL DEPTH	DIM. B REVEAL WIDTH	NUMBER	
		NON-VENTED	VENTED
1/2"	1/2"	DCS-50-50	DCS-50-V-50
1/2"	3/4"	DCS-50-75	DCS-50-V-75
1/2"	1"	DCS-50-100	DCS-50-V-100
1/2"	1 1/2"	DCS-50-150	DCS-50-V-150
1/2"	2"	DCS-50-200	DCS-50-V-200
1/2"	3"	DCS-50-300	DCS-50-V-300
1/2"	4"	DCS-50-400	DCS-50-V-400
5/8"	1/2"	DCS-625-50	DCS-625-V-50
5/8"	3/4"	DCS-625-75	DCS-625-V-75
5/8"	1"	DCS-625-100	DCS-625-V-100
5/8"	1 1/2"	DCS-625-150	DCS-625-V-150
5/8"	2"	DCS-625-200	DCS-625-V-200
5/8"	2 1/2"	DCS-625-250	DCS-625-V-250
5/8"	3"	DCS-625-300	DCS-625-V-300
5/8"	4"	DCS-625-400	DCS-625-V-400
5/8"	6"	DCS-625-600	DCS-625-V-600

**INSTALLATION DETAIL / Cross Section**

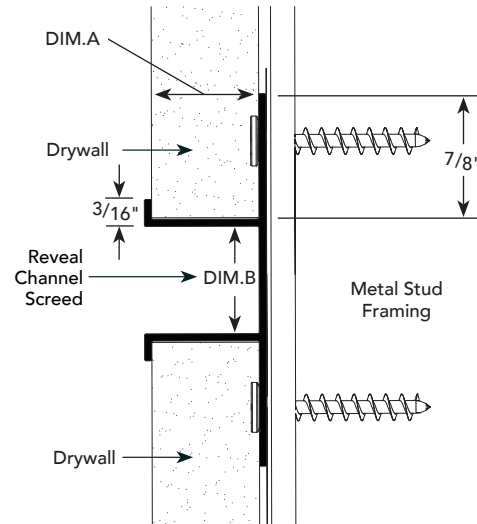

**DA.17**

**PRODUCT DETAIL**

**"F" REVEAL**

DIM. A REVEAL DEPTH	DIM. B REVEAL WIDTH	NUMBER	
		NON-VENTED	VENTED
1/2"	3/4"	FDM-50-75	FDM-50-V-75
5/8"	1/2"	FDM-625-50	FDM-625-V-50
5/8"	3/4"	FDM-625-75	FDM-625-V-75
5/8"	1"	FDM-625-100	FDM-625-V-100
5/8"	1 1/2"	FDM-625-150	FDM-625-V-150
5/8"	2 1/2"	FDM-625-250	FDM-625-V-250
5/8"	3"	FDM-625-300	FDM-625-V-300

**INSTALLATION DETAIL / Cross Section**

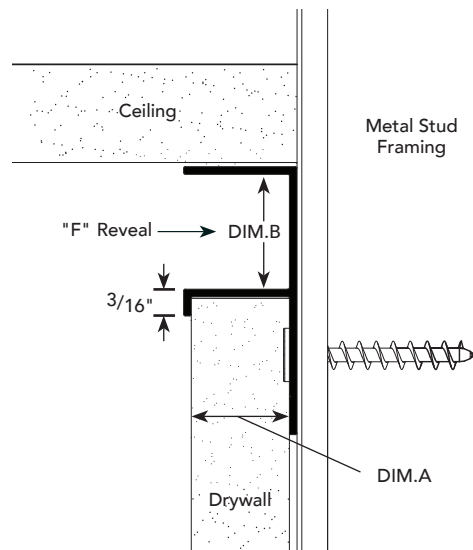

**DA.18**

**PRODUCT DETAIL**

**"T" MOLDING**

DIM. A REVEAL DEPTH	DIM. B REVEAL WIDTH	NUMBER	
		NON-VENTED	VENTED
1/2"	1/2"	TDM-50-50	TDM-50-V-50
1/2"	3/4"	TDM-50-75	TDM-50-V-75
1/2"	1 1/8"	TDM-50-1125	TDM-50-V-1125
1/2"	1 1/2"	TDM-50-150	TDM-50-V-150
5/8"	1/2"	TDM-625-50	TDM-625-V-50
5/8"	3/4"	TDM-625-75	TDM-625-V-75
5/8"	1 1/8"	TDM-625-1125	TDM-625-V-1125

**INSTALLATION DETAIL / Cross Section**

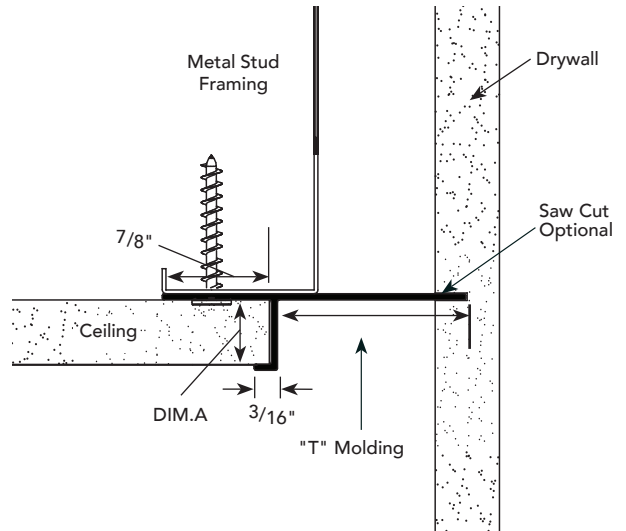

**DA.19**

**PRODUCT DETAIL**

**"X" MOLDING**

DIM. A.	NUMBER
1/2"	XDM-50-50
5/8"	XDM-625-625

**INSTALLATION DETAIL / Cross Section**

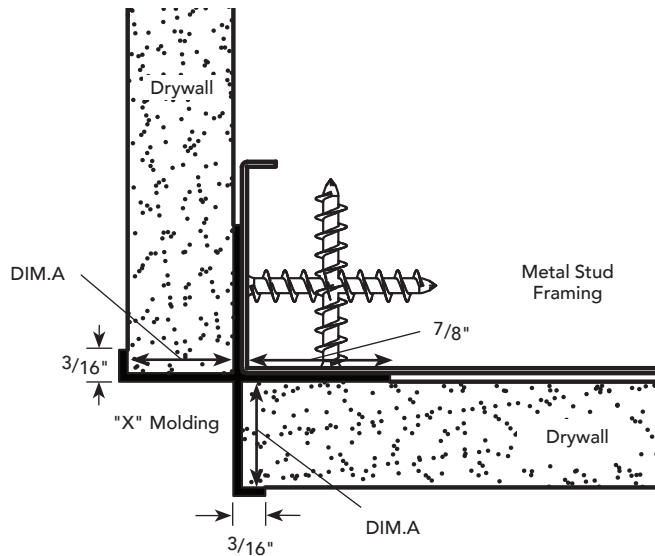

**DA.20** PRODUCT DETAIL

**"W" MOLDING**

DIM. A REVEAL DEPTH	DIM. B REVEAL WIDTH	DIM. C REVEAL DEPTH	NUMBER	
			NON-VENTED	VENTED
1/2"	1/2"	5/8"	WDM-50-50-625	--
1/2"	3/4"	1"	WDM-50-75	WDM-50-V-75
5/8"	3/4"	1"	WDM-625-75	WDM-625-V-75
3/4"	3/4"	5/8"	WRM-75-75-625	WRM-75-V-75-625

INSTALLATION DETAIL / Cross Section

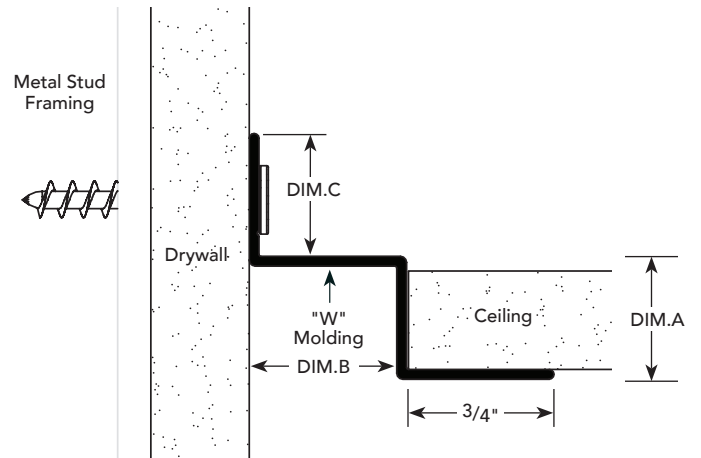

**DB.1** PRODUCT DETAIL

**DRYWALL  
EXPANSION  
JOINT**

GROUND	DIM. A REVEAL WIDTH	NUMBER	
		2-PIECE	3-PIECE
1/2"	1/4"	DRM-50-25 2-PC	--
1/2"	1/2"	DRM-50-50 2-PC	DRM-50-50 3-PC
1/2"	3/4"	DRM-50-75 2-PC	DRM-50-75 3-PC
1/2"	1"	--	DRM-50-100 3-PC
1/2"	1 1/2"	DRM-50-150 2-PC	DRM-50-150 3-PC

INSTALLATION DETAIL / Cross Section

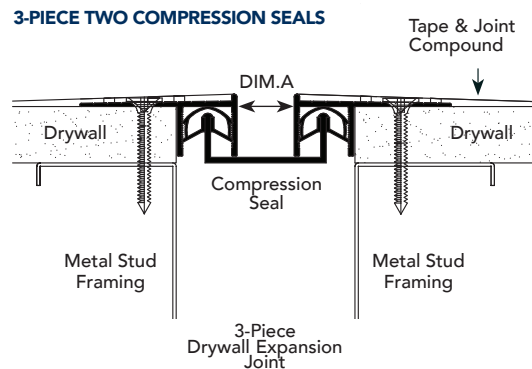
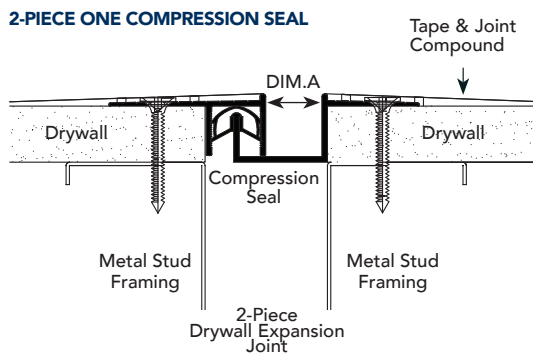

**DC.1** PRODUCT DETAIL

INSTALLATION DETAIL / Cross Section

**CORNER TRIM**

DIM. A. EXPOSED CORNER	NUMBER
3/8"	DMCT-375
1 1/4"	DMCT-1250

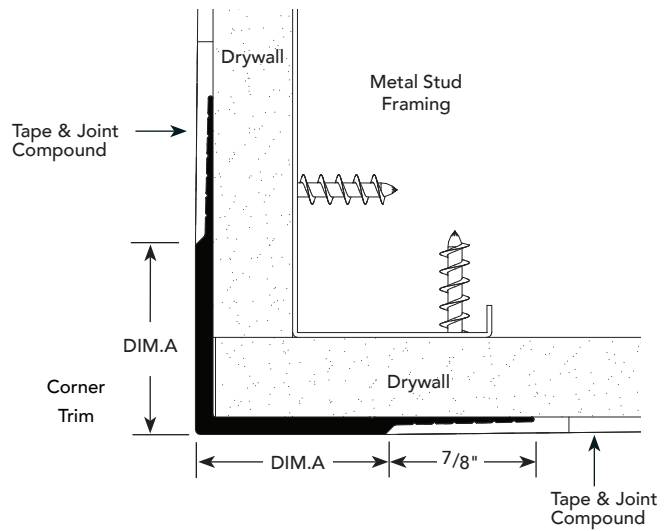

**DC.2** PRODUCT DETAIL

INSTALLATION DETAIL / Cross Section

**"L" TRIM MOLDING**

DIM. A TRIM DEPTH	NUMBER
1/2"	DRML-50
5/8"	DRML-625
3/4"	DRML-75
1"	DRML-100
1 1/4"	DRML-1250
1 1/2"	DRML-150
1 5/8"	DRML-1625
2"	DRML-200
2 1/2"	DRML-250
3"	DRML-300

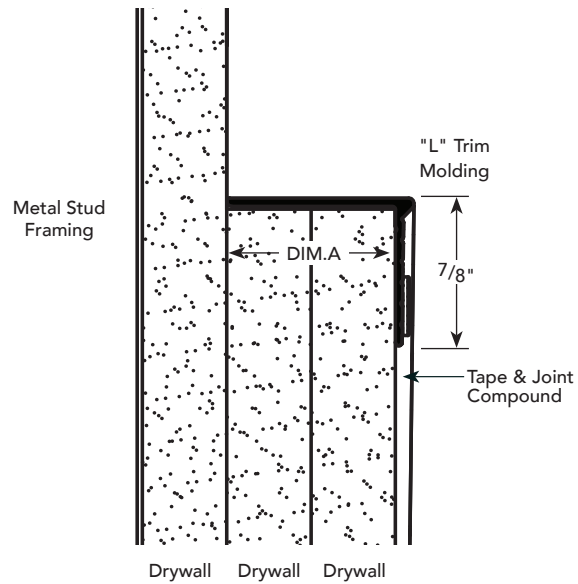



**DC.3** PRODUCT DETAIL

**EDGE TRIM**

DIM A. TRIM DEPTH	NUMBER
1/2" ●	DMET-50
1" ■	DMET-100
1 1/2" ▲	DMET-150

- Additional layer of 1/2" drywall
- Two additional layers of 1/2" drywall
- ▲ Three additional layers of 1/2" drywall

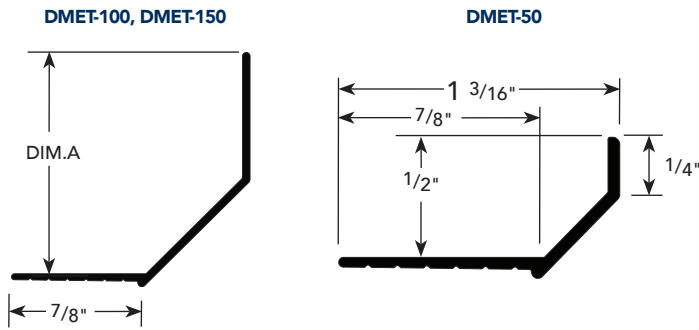

INSTALLATION DETAIL / Cross Section

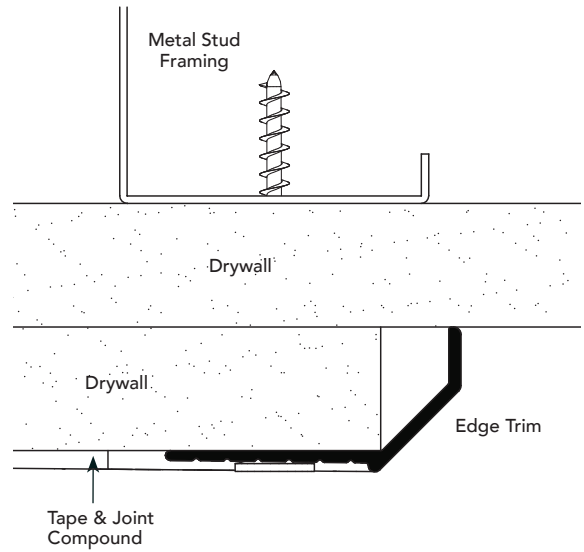

**DC.4** PRODUCT DETAIL

**EDGE TRIM**

DIM A. TRIM DEPTH	NUMBER
1/2" ●	DRME-50
5/8" ■	DRME-625
1 1/4"	DRME-1250

- Additional layer of 1/2" drywall
- Two additional layers of 5/8" drywall

INSTALLATION DETAIL / Cross Section

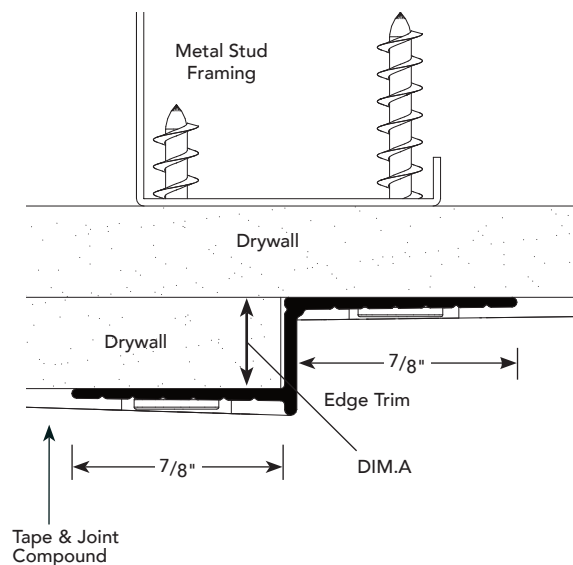

**DC.5**

**PRODUCT DETAIL**

**INSTALLATION DETAIL / Cross Section**

**RADIUS CORNER TRIM**

DIM A.	NUMBER
1/2"	RCT-50

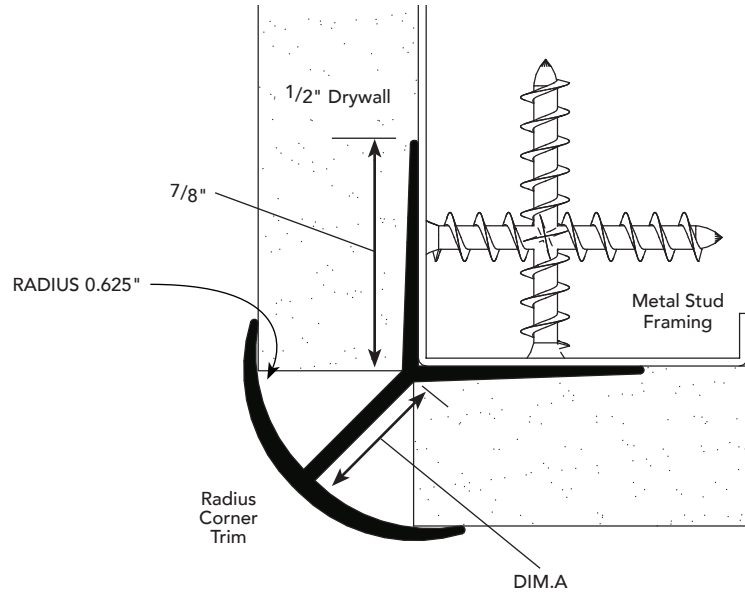

**DC.6**

**PRODUCT DETAIL**

**INSTALLATION DETAIL / Cross Section**

**POCKET TRIM**

WIDTH OF TILE SUPPORT	NUMBER
3/4"	DMPT-75

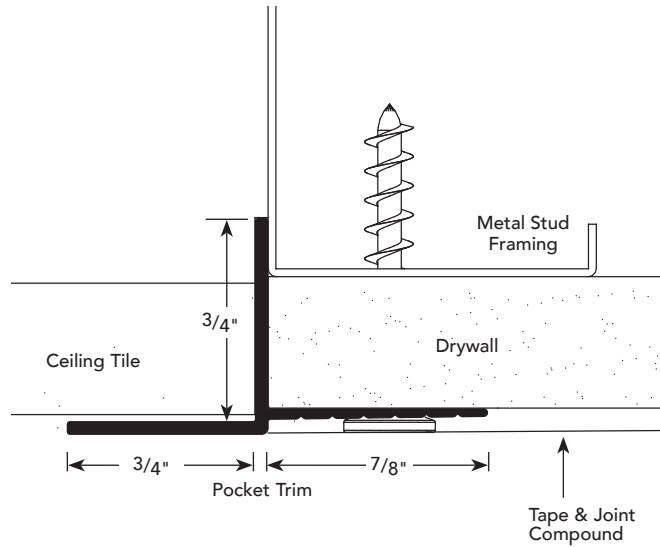

**DC.7** PRODUCT DETAIL

**"J" MOLDING**

DIM. A.	DIM. B.	DIM. C.	NUMBER
1/2"	3/16"	1 1/16"	JDM-50
5/8"	3/16"	1 1/16"	JDM-625

INSTALLATION DETAIL / Cross Section

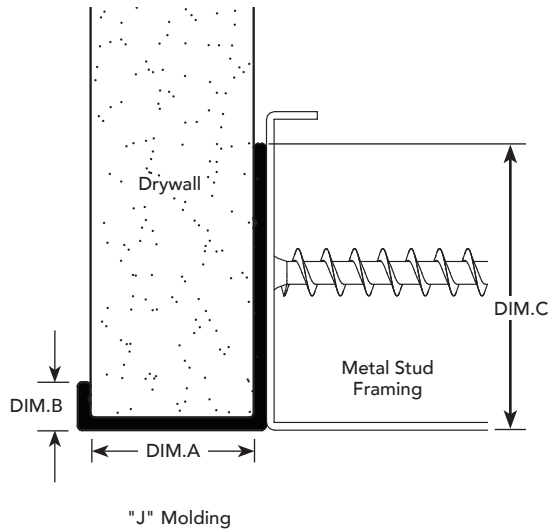

**DC.8** PRODUCT DETAIL

**DRYWALL MOLDING END CLOSURE**

DIM. A*	NUMBER
2"	DMEC-200
3 1/2"	DMEC-3500
3 3/4"	DMEC-3750
4 5/8"	DMEC-4625
4 7/8"	DMEC-4875
7 1/4"	DMEC-7250

INSTALLATION DETAIL / Cross Section

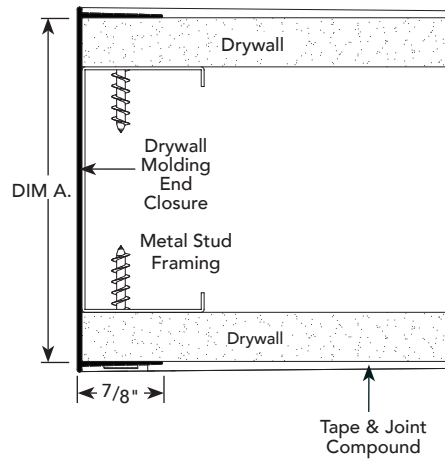

**DC.9**    **PRODUCT DETAIL**

**TOP TRACK**

REVEAL DEPTH (DRYWALL THICKNESS)	DIM. A STUD WIDTH	NUMBER
5/8"	3 5/8"	DMTT-625-3750

**INSTALLATION DETAIL / Cross Section**

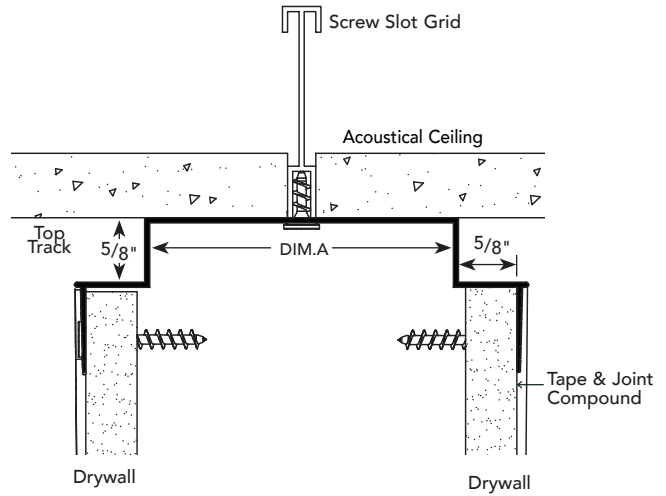

**DC.10**    **PRODUCT DETAIL**

**CEILING TRIM**

DIM. A	DIM. B	NUMBER
1/2"	1/2"	DRMCT-50-50
5/8"	3/4"	DRMCT-625-75
5/8"	1"	DRMCT-625-100

**INSTALLATION DETAIL / Cross Section**

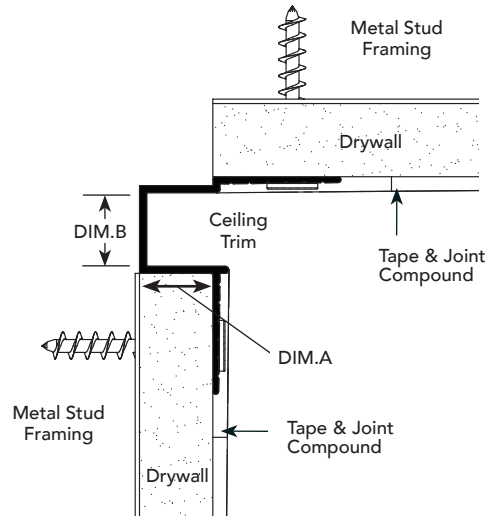

**DC.11** PRODUCT DETAIL

**PROTRUDING  
EDGE  
PROFILES**

DIM. A	DIM. B	NUMBER
3/8"	N/A	DRMPET-375
1"	N/A	DRMPET-100
1"	3/4"	DRMPWR-100-75
1"	1"	DRMPCR-100-100

INSTALLATION DETAIL / Cross Section

**DRMPET-375**

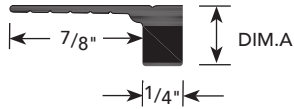

**DRMPET-100**

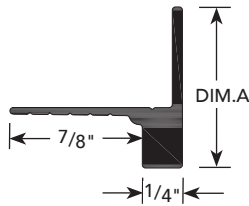

**DRMPWR-100-75**

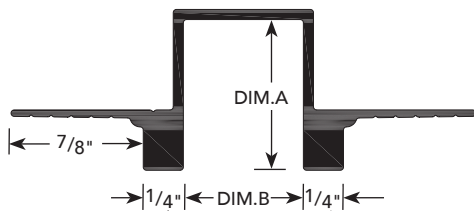

**DRMPCR-100-100**

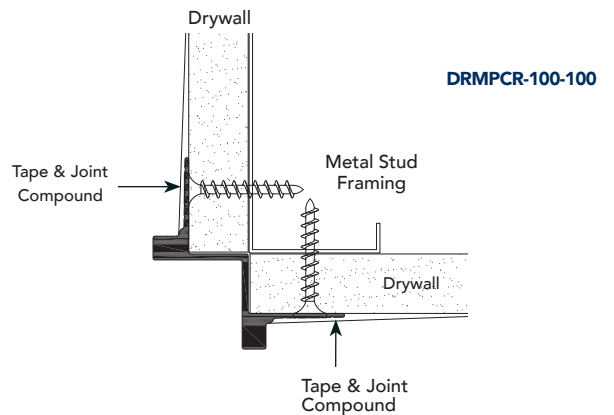
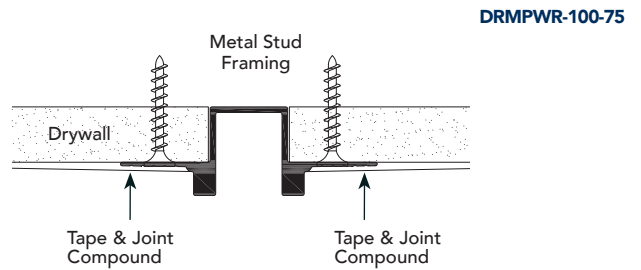
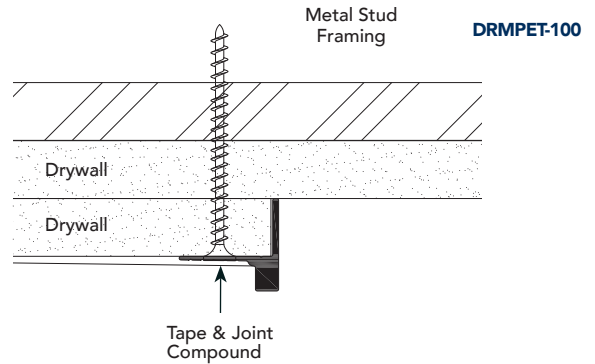
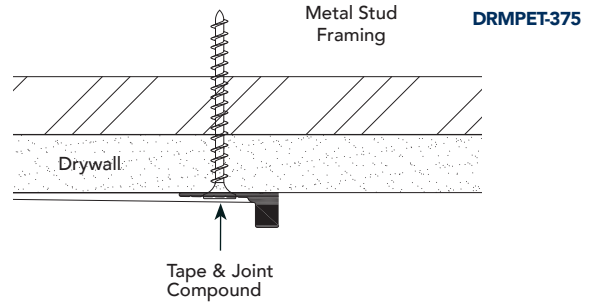
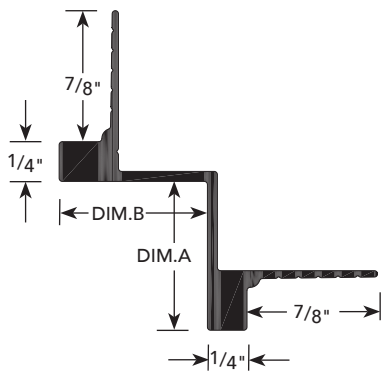

**DC.12**

**PRODUCT DETAIL**

**30° / 45° ANGLE TRIM**

DIM A	DIM B	NUMBER
30°	2 7/8"	DMAT-30-500
45°	4 1/8"	DMAT-45-500

**INSTALLATION DETAIL / Cross Section**

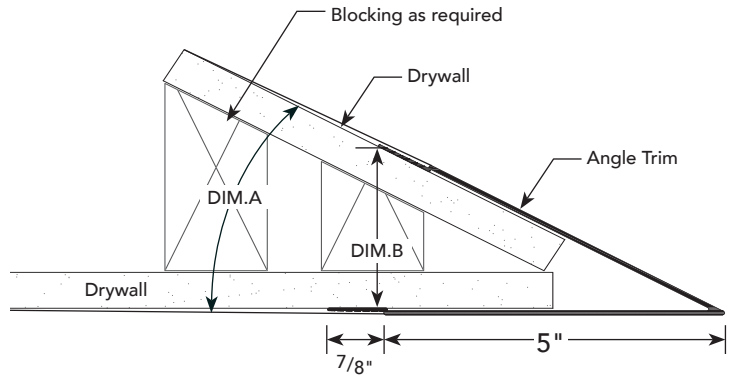

**DC.13**

**PRODUCT DETAIL**

**WALL ANGLE**

DIM A	DIM B	NUMBER
3/4"	1"	WA75100
1"	2"	WA100200

**CROSS SECTION / INSTALLATION DETAIL**

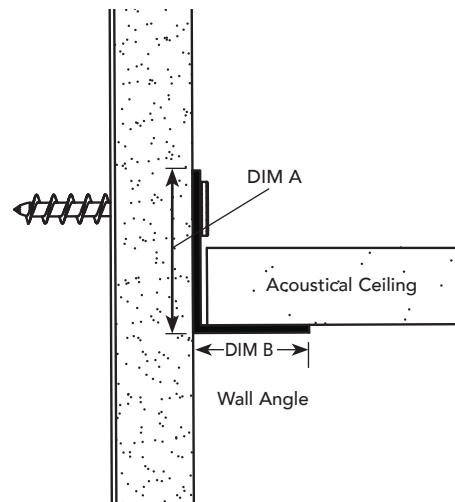

**DD.1** PRODUCT DETAIL

**STEPPED  
OUTSIDE  
CORNER** / **DRYWALL  
CORNER  
REVEAL**

DIM. A NOTCH WIDTH	DIM. B NOTCH HEIGHT	NUMBER
1/2"	1/2"	DRMW 50-50
1/2"	1 1/2"	DRMW 50-150
5/8"	5/8"	DRMW 625-625
1 1/2"	1 1/2"	DRMW 150-150

INSTALLATION DETAIL / Cross Section

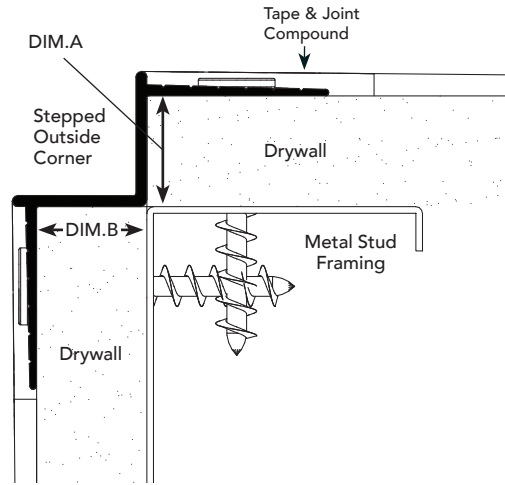

**DD.2** PRODUCT DETAIL

**MULTIPLE STEPPED  
OUTSIDE CORNER**

DIM. A	NUMBER
5/8"	DMOS-625
1 1/2"	DMOS-150

INSTALLATION DETAIL / Cross Section

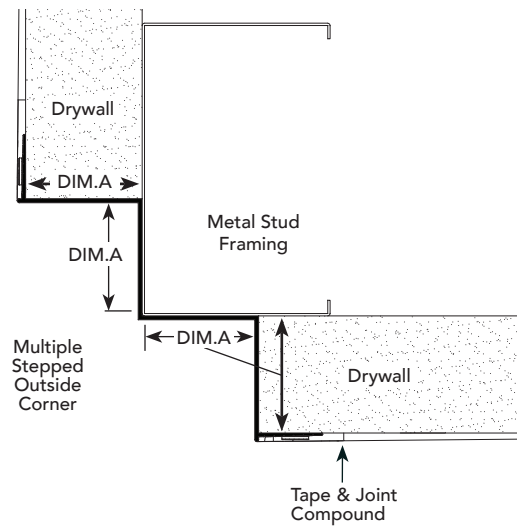

**DD.3** PRODUCT DETAIL

INSTALLATION DETAIL / Cross Section

**BEVELED  
CORNER**

BEVEL WIDTH	NUMBER
3/4"	DMBC-75

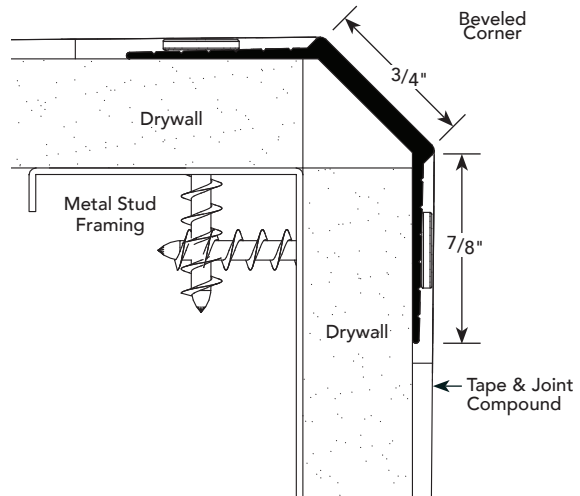

**DD.4** PRODUCT DETAIL

INSTALLATION DETAIL / Cross Section

**CURVED  
INSIDE  
CORNER**

"R" RADIUS	DIM A	NUMBER
3/4"	1 1/4"	DRMC-IS-75
1"	1 9/16"	DRMC-IS-100
1 1/2"	2 5/16"	DRMC-IS-150
2"	2 7/8"	DRMC-IS-200
3"	4 1/4"	DRMC-IS-300
4"	5 5/8"	DRMC-IS-400
6"	8 7/16"	DRMC-IS-600

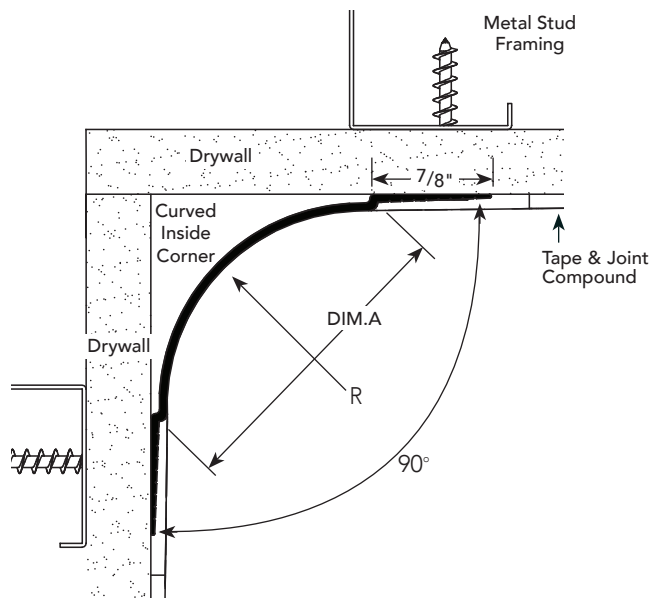



**DD.5** PRODUCT DETAIL

**CURVED OUTSIDE CORNER**

"R" RADIUS	DIM A	NUMBER
5/8"	1"	DRMC-OS-625
3/4"	1"	DRMC-OS-75
1"	1 3/8"	DRMC-OS-100
1 1/2"	2 1/8"	DRMC-OS-150
2"	2 3/4"	DRMC-OS-200
2 1/2"	3 9/16"	DRMC-OS-250
3"	4 3/16"	DRMC-OS-300
4"	5 11/16"	DRMC-OS-400

INSTALLATION DETAIL / Cross Section

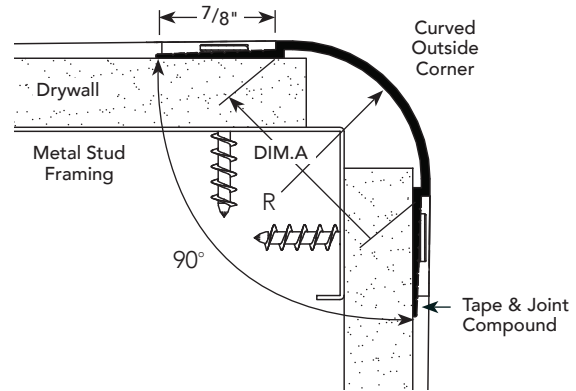

\*Contact Fry Reglet for installation recommendations

**DD.6** PRODUCT DETAIL

**BULLNOSE**

DIM. A DRYWALL THICKNESS	DIM. B STUD WIDTH	NUMBER
5/8"	2 1/2"	DBN-625-250
5/8"	3 5/8"	DBN-625-3625

INSTALLATION DETAIL / Cross Section

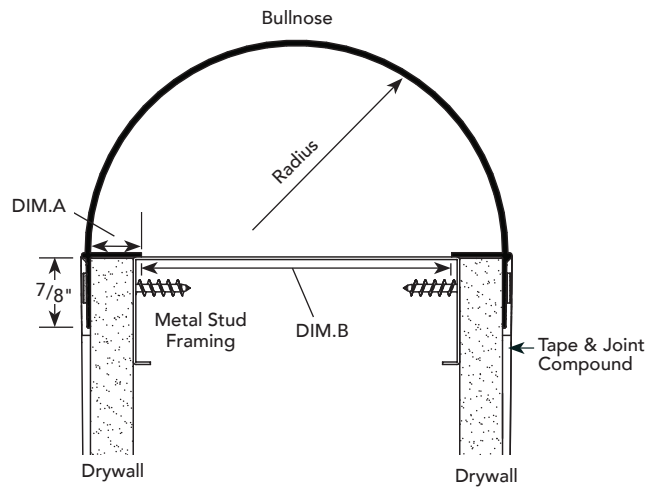

**DE.1**

**PRODUCT DETAIL**

**INSTALLATION DETAIL / Cross Section**

**COLUMN COLLAR**

**DRYWALL**

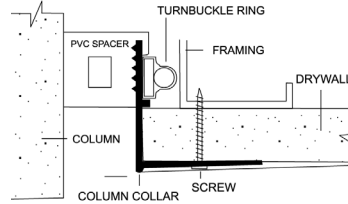
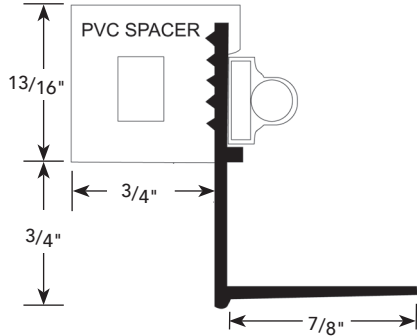

**ACOUSTICAL/DRYWALL**

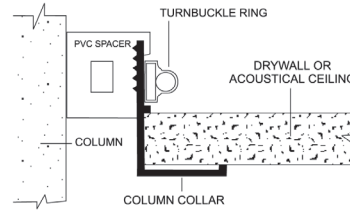
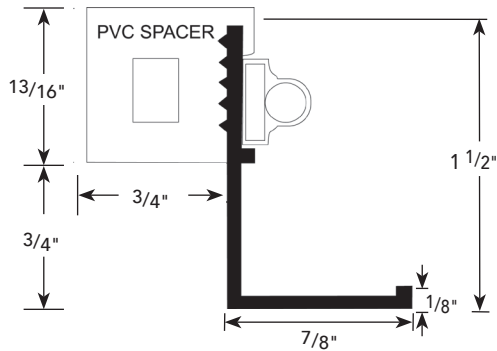

**PLASTER**

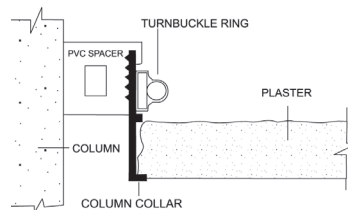
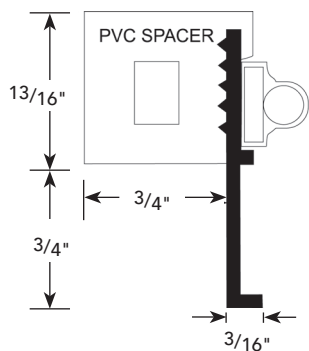

**USAGE**

Fry Reglet Column Collar provides a functional, attractive trim creating a reveal at column/ceiling joint. PVC spacer insures an attractive appearance and no light leaks. Fabricated to fit specific column sizes. Tightens in place with a turnbuckle and stainless steel metal band. Available with white or dark bronze PVC spacer. Finish is clear anodized, painted or finished with a chemical conversion coating for field painting.

Column covers are manufactured to fit specific columns from 10" to 48" in diameter.

**DE.2** PRODUCT DETAIL

**REVEAL COLUMN RING**

COLUMN DIAMETERS 18" TO 48"

DIM. A REVEAL WIDTH	DIM. B REVEAL DEPTH	NUMBER
1/2"	1/2"	WDM-50-50-625
1/2"	1/2"	DRWT-50-50
3/4"	3/4"	WRM-75-75-625
3/4"	3/4"	DRWT-75-75

INSTALLATION DETAIL / Cross Section

**DRYWALL (DRWT)**

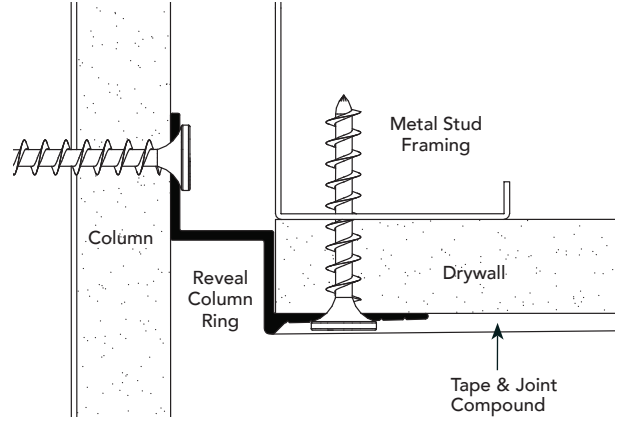

**DRYWALL (DRWT)**

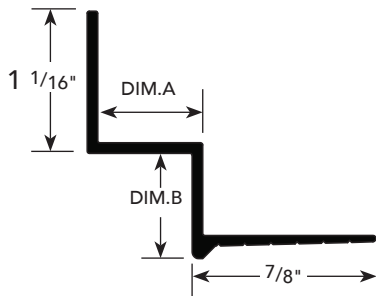

**ACOUSTICAL (WDM)**

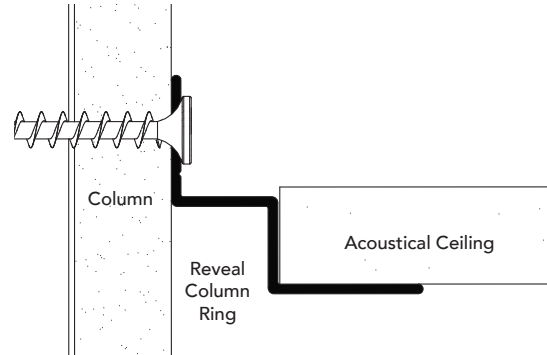

**ACOUSTICAL (WDM)/WRM**

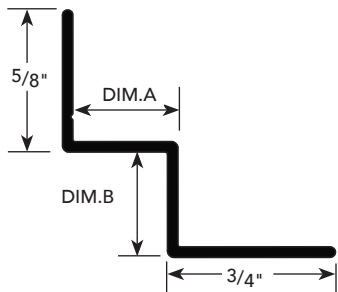

**COLUMN RING DETAIL**

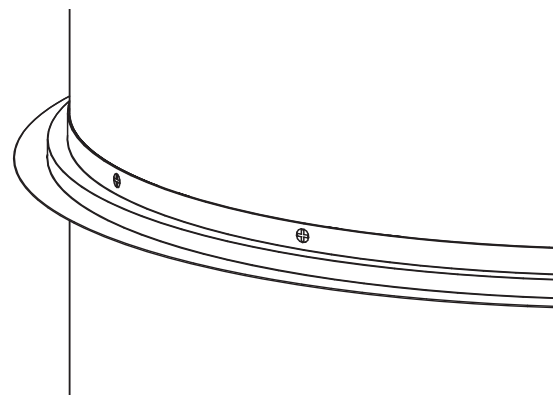

**DE.3**

**PRODUCT DETAIL**

**INSTALLATION DETAIL / Cross Section**

**WALL ANGLE COLUMN RING**

COLUMN DIAMETERS 18" TO 48"

TYPE	NUMBER
Acoustical	Wall Angle
Drywall	Wall Angle w/Taping Flange

**DRYWALL**

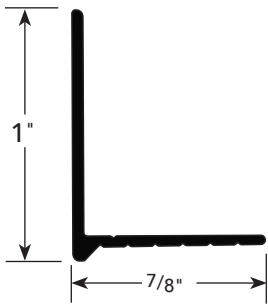

DRML -100

**ACOUSTICAL/DRYWALL**

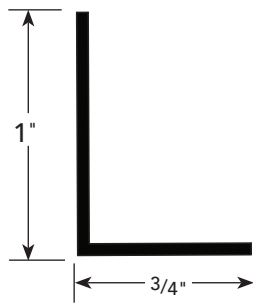

M1WA 120

**DRYWALL CROSS SECTION)**

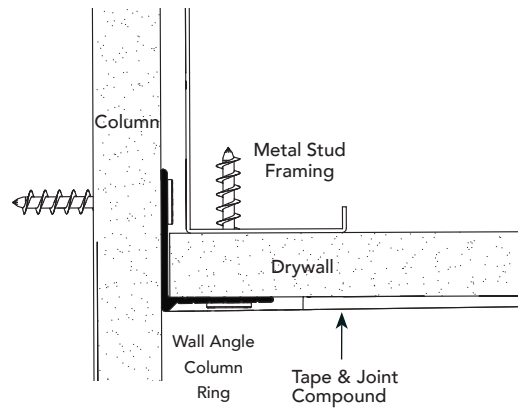

**ACOUSTICAL/DRYWALL CROSS SECTION)**

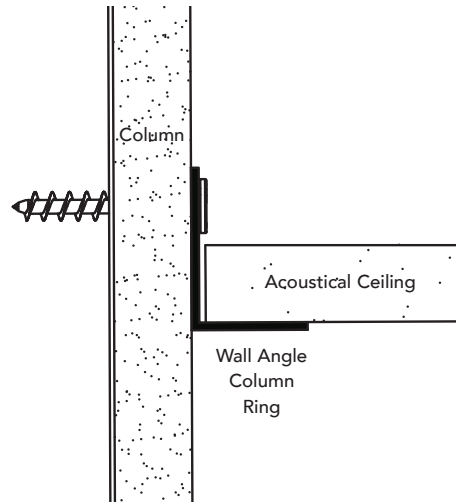

**DF.1** PRODUCT DETAIL

INSTALLATION DETAIL / Cross Section

**"W" REVEAL MOLDING**

DIM. A REVEAL DEPTH	DIM. B REVEAL WIDTH	DIM. C REVEAL DEPTH	NUMBER	
			NON-VENTED	VENTED
1/2"	1/2"	5/8"	WDM-50-50-625	WDM-50-V-50-625
1/2"	3/4"	1"	WDM-50-75	WDM-50-V-75
5/8"	3/4"	1"	WDM-625-75	WDM-625-V-75
3/4"	3/4"	5/8"	WRM-75-75-625	WRM-75-V-75-625

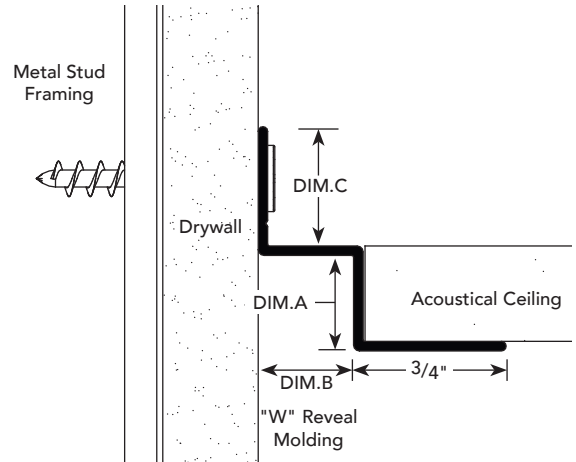

**DF.2** PRODUCT DETAIL

INSTALLATION DETAIL / Cross Section

**DRYWALL / ACOUSTICAL REVEAL**

REVEAL DEPTH	DIM. A	NUMBER
1/2"	1/2"	DRMAD-50-50
1/2"	3/4"	DRMAD-50-75

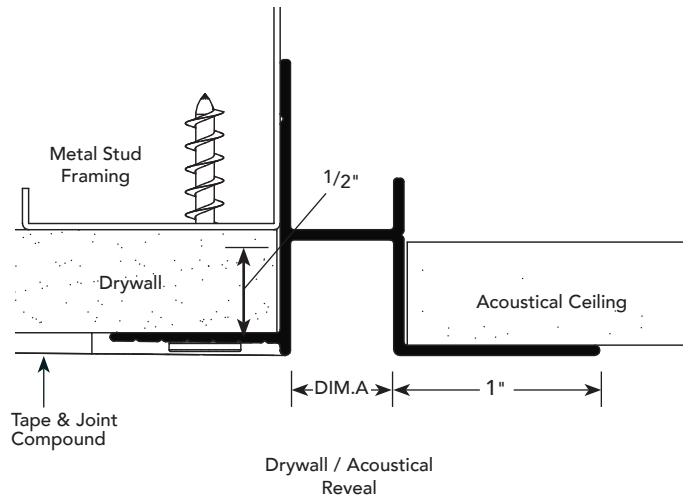

**DF.3** PRODUCT DETAIL

**ACOUSTICAL  
CEILING TRIM**

DIM. A	NUMBER
3/4"	DRAT-75
1"	DRAT-100

INSTALLATION DETAIL / Cross Section

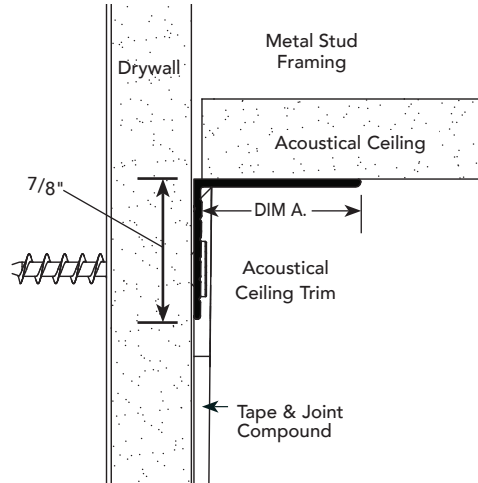

**DF.4** PRODUCT DETAIL

**ACOUSTICAL  
MOLDING**

DIM. A STEP WIDTH	DIM. B STEP DEPTH	USAGE	NUMBER
1/2"	1/2"	1/2" Drywall	FDA-50
5/8"	5/8"	5/8" Drywall	FDA-625
3/4"	3/4"	3/4" Plaster	FDA-75

INSTALLATION DETAIL / Cross Section

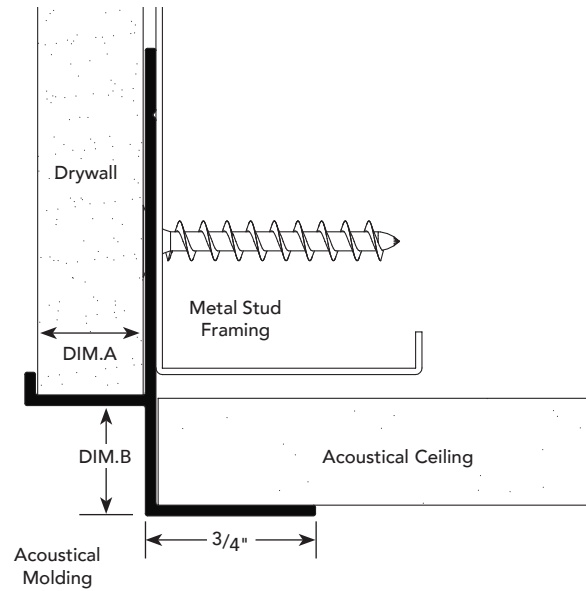

**DF.5** PRODUCT DETAIL

**"W" ACOUSTICAL REVEAL**

MATERIAL POCKET	REVEAL WIDTH	NUMBER	
		NON-VENTED	VENTED
7/8"	3/4"	WARM-875-75	WARM-875-V-75

INSTALLATION DETAIL / Cross Section

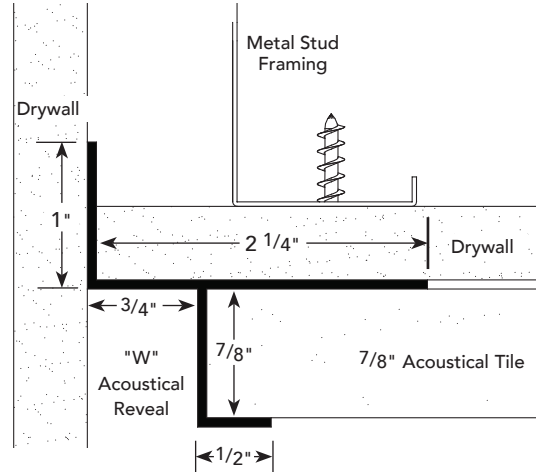

**DF.6** PRODUCT DETAIL

**"F" ACOUSTICAL REVEAL**

REVEAL DEPTH	REVEAL WIDTH	NUMBER	
		NON-VENTED	VENTED
7/8"	3/4"	FARM-875-75	FARM-875-V-75

INSTALLATION DETAIL / Cross Section

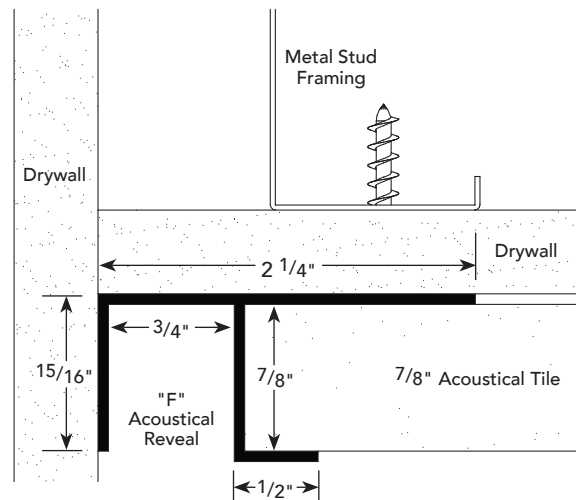

**DF.7**

**PRODUCT DETAIL**

**"J" ACOUSTICAL TRIM**

"J" DEPTH	NUMBER
7/8"	JAM-875

**INSTALLATION DETAIL / Cross Section**

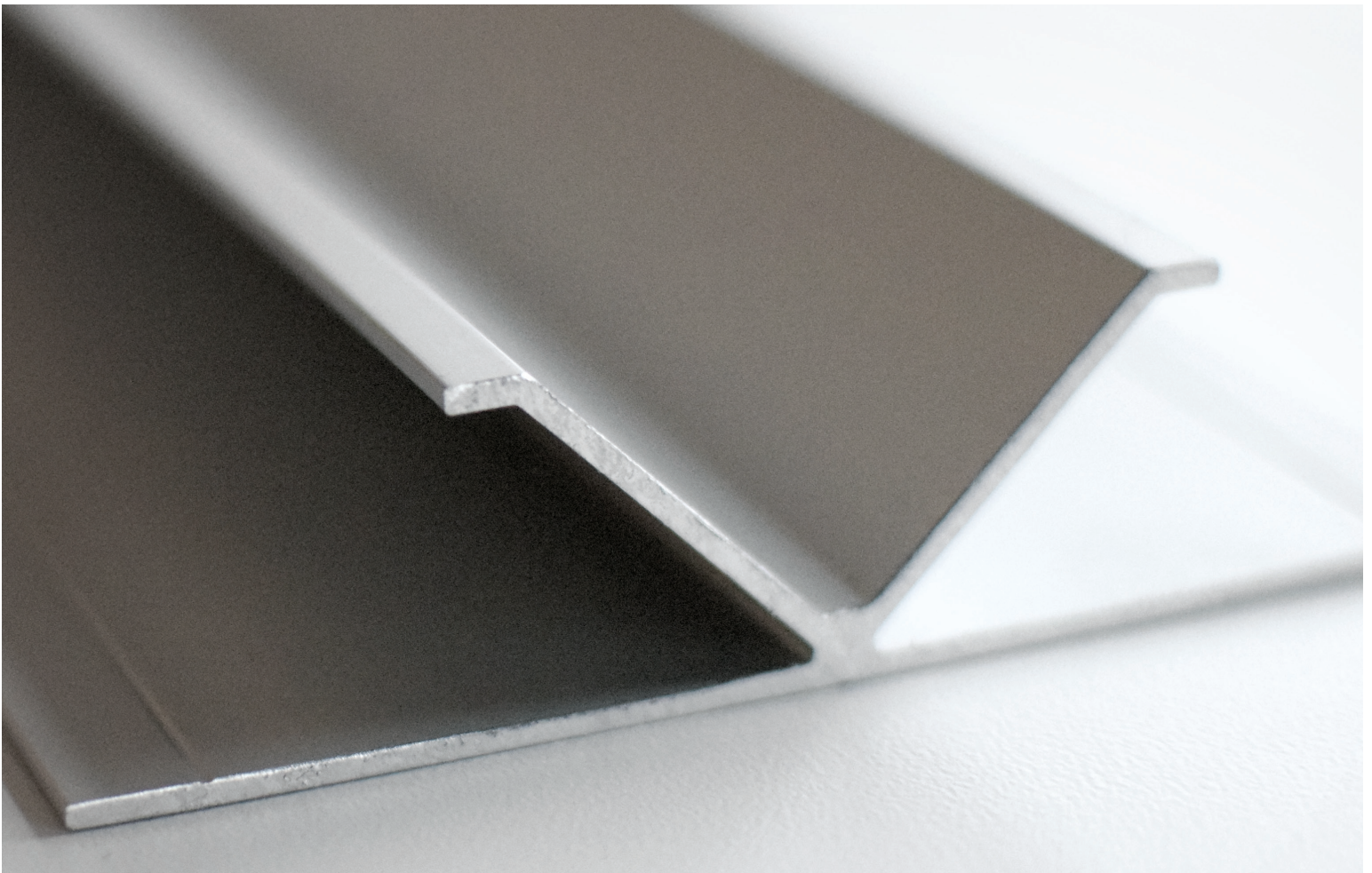
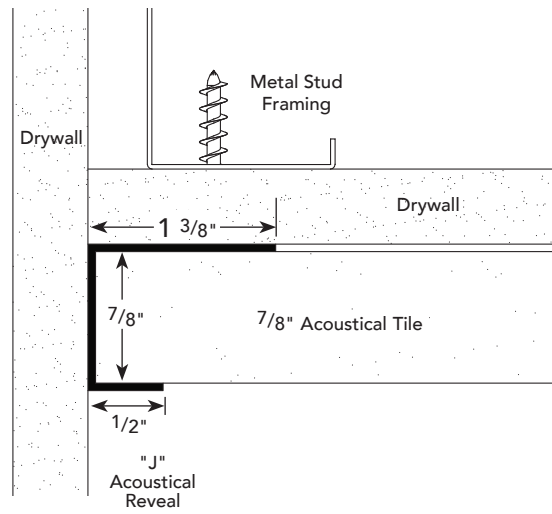



**DG.1** PRODUCT DETAILS

SPECIAL SECTIONS

PRM MOLDING / PART NO. 1270

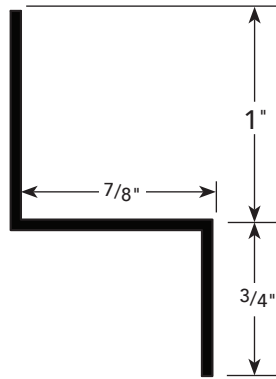

SPECIAL REVEAL MOLDING / PART NO. 1054

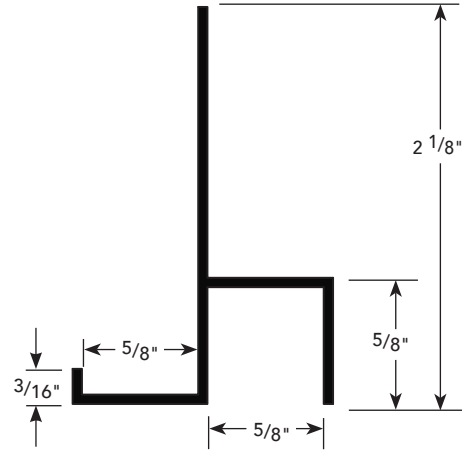

MODIFIED CHANNEL MOLDING / PART NO. 1858

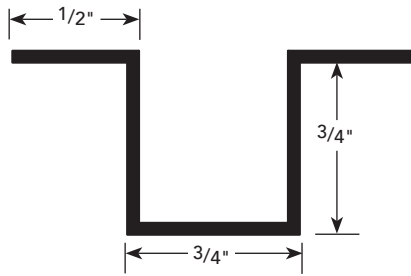

SPECIAL REVEAL MOLDING / PART NO. "T" PIECE

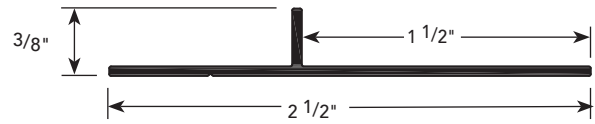

SPECIAL "J" MOLDINGS / PART NO. 1360

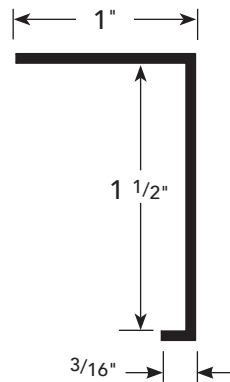

**DG.1**

**PRODUCT DETAILS**

**SPECIAL SECTIONS**

**SPECIAL "J" MOLDINGS / PART NO. 2054**

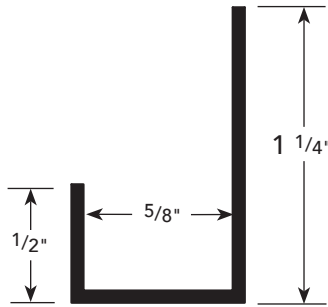

**SPECIAL "J" MOLDINGS / PART NO. 1262**

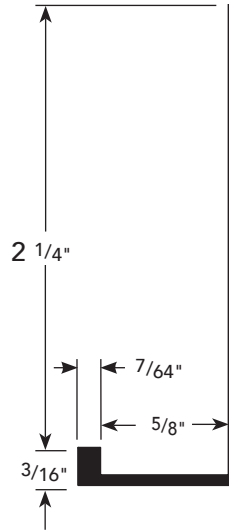

**DG.2**

**PRODUCT DETAIL**

**CONTEMPORARY REVEALS**

DIM. A REVEAL DEPTH	DIM. B REVEAL WIDTH	NUMBER
1/2"	1/2"	CDRM-50-50
1/2"	3/4"	CDRM-50-75
1/2"	1"	CDRM-50-100
5/8"	1/2"	CDRM-625-50
5/8"	5/8"	CDRM-625-625
5/8"	3/4"	CDRM-625-75
5/8"	1"	CDRM-625-100

**INSTALLATION DETAIL / Cross Section**

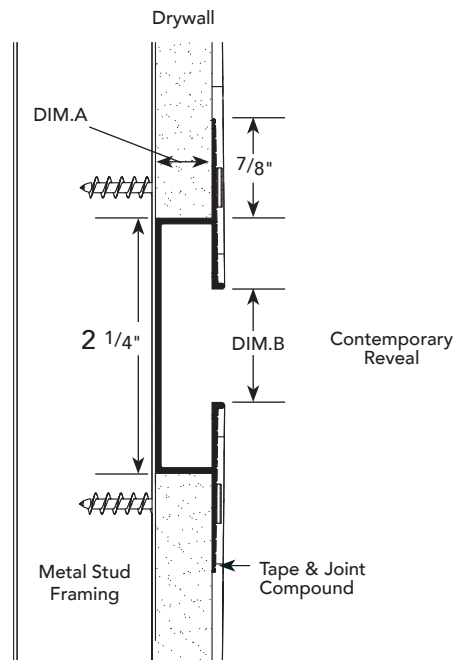

**DH.1** PRODUCT DETAIL

**GLAZING TRACK**

DIM A	NUMBER
3 1/2"	DMGT 3500
3 3/4"	DMGT 3750
4 5/8"	DMGT 4625
4 7/8"	DMGT 4875
7 1/4"	DMGT 7250

INSTALLATION DETAIL / Cross Section

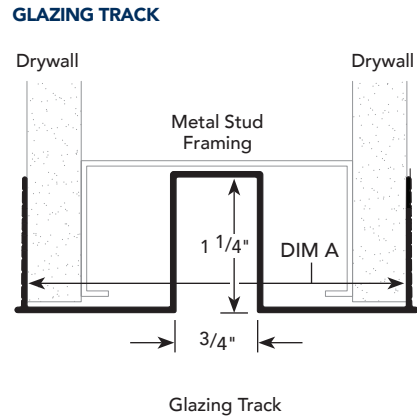

**GLASS GASKET SIZES**

GLASS SIZE	GASKET NUMBER
FOR USE WITH 1/4" GLASS	RR 3657
FOR USE WITH 3/8" GLASS	RR 3654
FOR USE WITH 1/2" GLASS	RR 3730

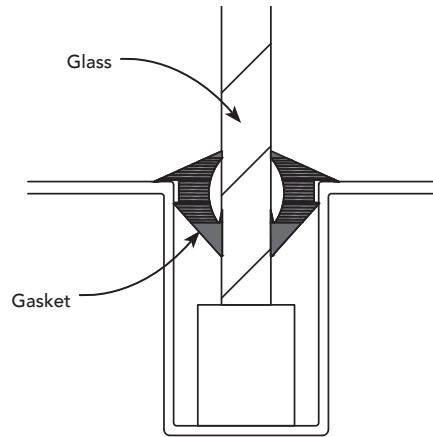

**DRYWALL CEILING TRACK (DRM-150-75)**

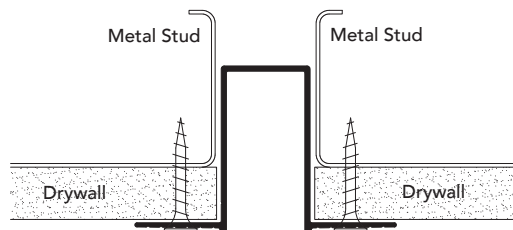
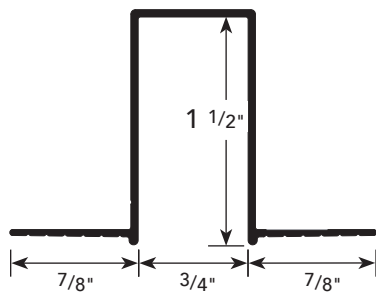

**DH.2**

**PRODUCT DETAIL**

**INSTALLATION DETAIL / Cross Section**

**GLAZING TRACK**

DIM. A	NUMBER
3 1/2"	DMEC 3500
3 3/4"	DMEC 3750
4 5/8"	DMEC 4625
4 7/8"	DMEC 4875

**DRYWALL MOLDING END CLOSURE (DMEC)**

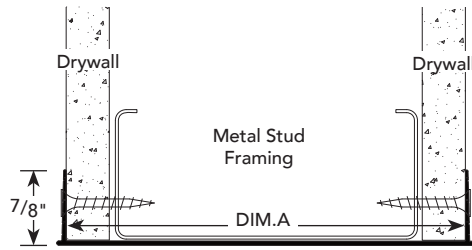

DMEC

**ACOUSTICAL CEILING TRACK (ARM-150-75)**

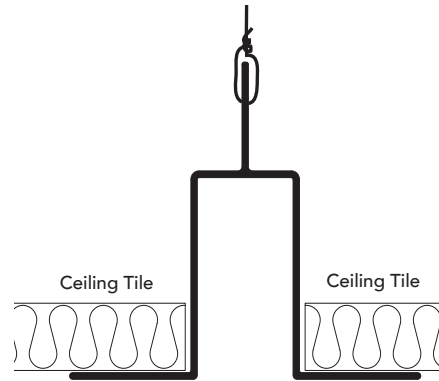
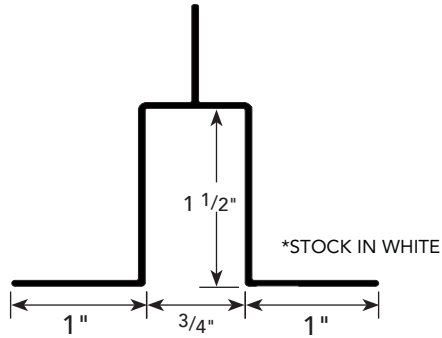

**DRYWALL/ACOUSTICAL CEILING TRACK (DRMAD-150-75)**

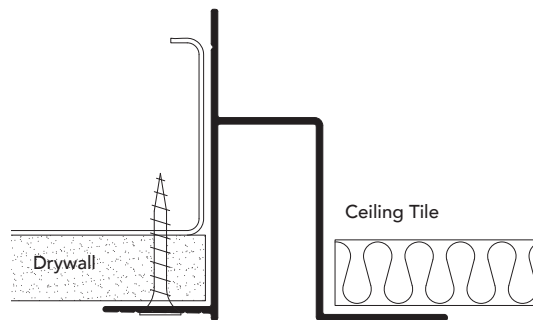
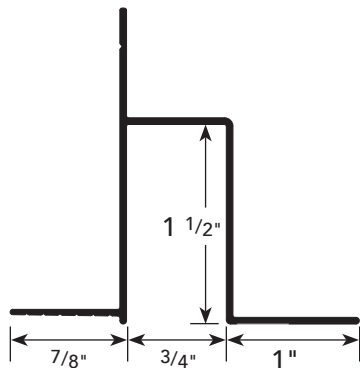

DI.1

PRODUCT DETAIL

INTEGRATED  
FUNCTION  
REVEAL

INSTALLATION DETAIL / Cross Section

INTEGRATED FUNCTIONAL REVEAL RAIL (IFRREVEAL)

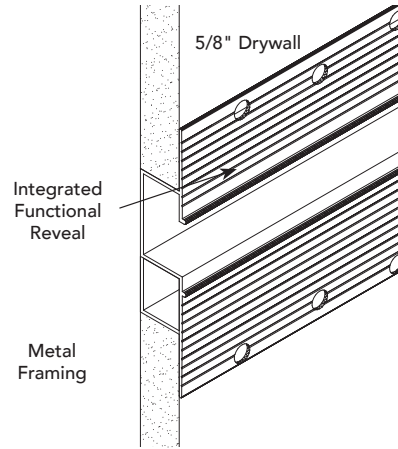
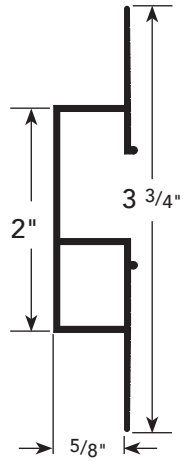

USAGE

Fry Reglet Integrated Functional Reveal Rail creates a Horizontal reveal designed to accept a chartrail insert and hook insert. Provides an aesthetic reveal that is fully integrated into dry wall.

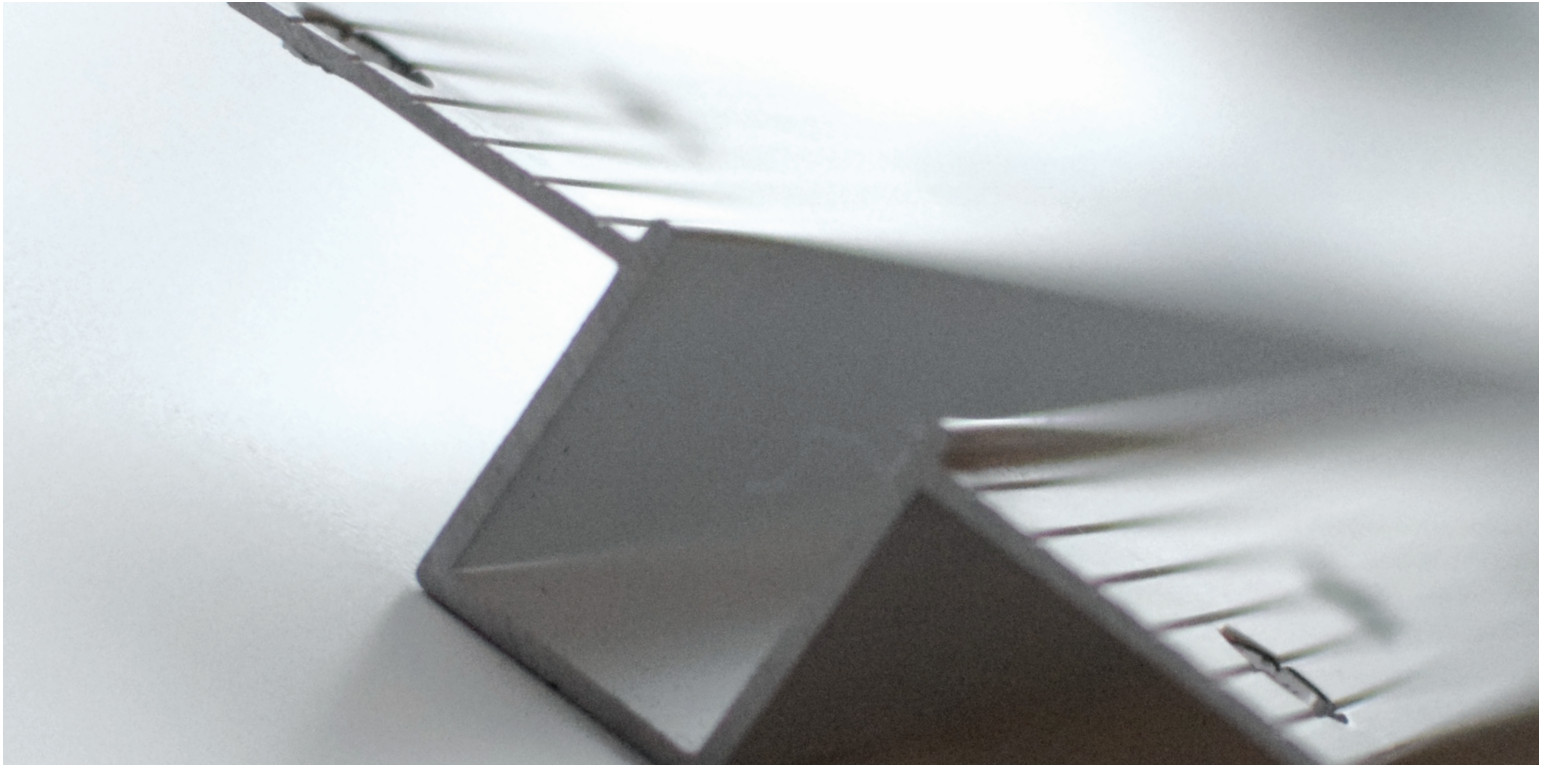

DI.1

PRODUCT DETAIL

INTEGRATED FUNCTION REVEAL

INSTALLATION DETAIL / Cross Section

2" AND 3" CHARTRAIL INSERT (IFRCHARTRAIL) (IFR3CHARTRAIL)

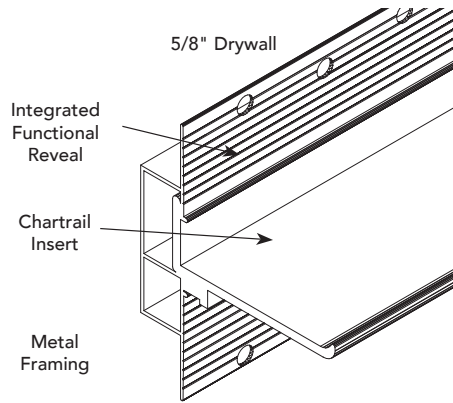
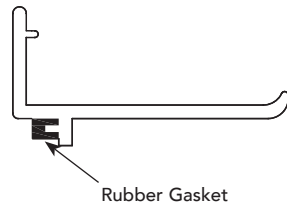

USAGE

Fry Reglet 2" and 3" Chartrail Insert to be inserted into the Integrated Functional Reveal Rail. Chartrail can be used to hold markers or as a stand for presentations or artwork.

GUIDE SPECIFICATION

Where indicated on drawings, Fry Reglet Chartrail Insert shall be installed. Aluminum shall be extruded alloy 6063 T5, with chemical conversion coating, clear anodized or other specified finish. Refer to finish section.

HOOK INSERT (IFRHOOKINSERT)

\*(Hook insert) sold separately.  
Note: Maximum capacity per hook insert is 75 pounds.  
Not to exceed 4 clips per 10ft. peice

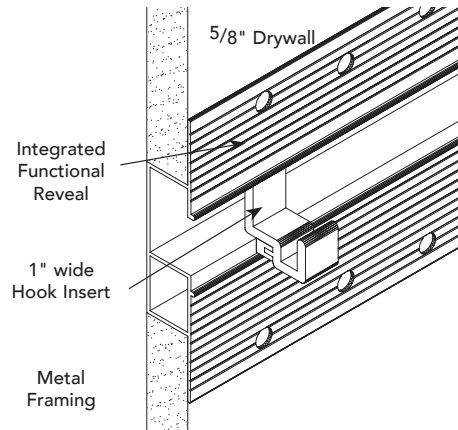
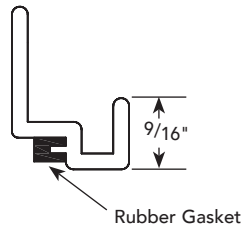

USAGE

Fry Reglet Hook Insert is designed to be inserted into the Integrated Functional Reveal Rail. Hooks can be placed anywhere on the reveal as needed, and repositioned for different sized objects like artwork, photography or presentations.

GUIDE SPECIFICATION

Where indicated on drawings, Fry Reglet Hook Insert shall be installed. Aluminum shall be extruded alloy 6063 T5. Standard finish clear anodized.

## DJ.1

## INSTALLATION

INSTALLATION  
GUIDE

## TAPEABLE FLANGE SHAPES:

1. The moldings are installed after the gypsum board is installed. The installer can either provide space for the moldings at the time of installation or cut the board with a router.
2. The framer should provide backing so moldings may be attached with #6 drywall screws 16" o.c. for horizontal applications.
3. Prior to taping, the attachment flanges should be cleaned using a non-abrasive cleaner and soft rag. When veneer plaster is specified, the flanges must be treated with a bonding agent.
4. Make sure the tape does not overlap the edge of the reveal and an 8" wide trowel is used to apply the final skim coat.
5. Fiberglass, self-adhesive drywall tape will cut taping time and help to avoid possible cracking.

## NON-TAPEABLE FLANGE SHAPES:

1. These types are installed prior to drywall installation and generally do not require taping or spackling.

## ADDING SNAP-INS

1. When the reveal molding is used with the Snap-In, use the base molding with 1/2" ground when installing 1/2" drywall, and base molding with 5/8" ground when installing 5/8" drywall. (See "Right Way")
2. Make sure base is supported to ensure that the base does not become deformed when applying Snap-In.
3. NEVER use 1/2" base with 5/8" drywall when adding Snap-In. (See "Wrong Way")

## RIGHT WAY

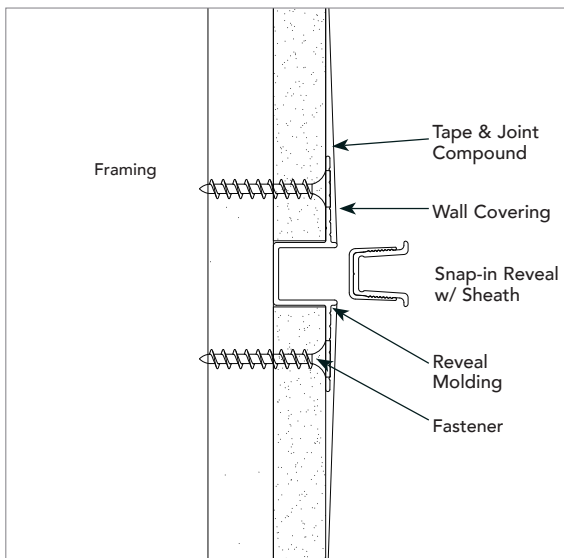

CORRECT INSTALLATION:  
MOLDING INSTALLED FLUSH TO FRAMING

## WRONG WAY

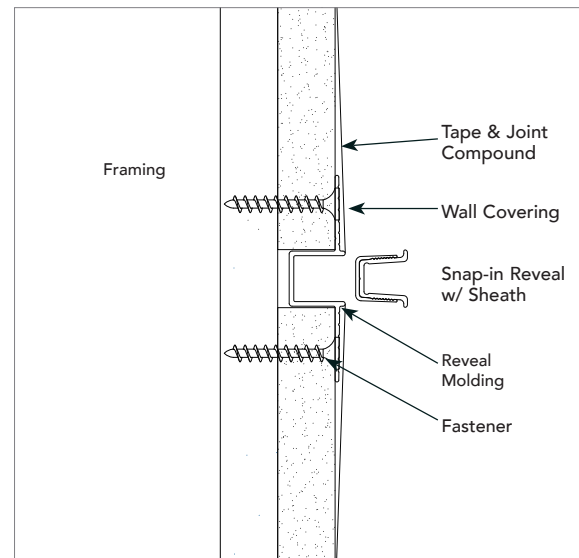

INCORRECT INSTALLATION:  
MOLDING NOT INSTALLED FLUSH TO FRAMING

## DJ.2

## FACTORY FABRICATED INTERSECTIONS

### INSTALLATION GUIDE

Factory fabricated intersections are available to connect horizontal and vertical joints of moldings of the same or different types. Intersections are available in "T", "L", and "+" shapes. The mitered joints are welded and the 6" legs are measured from the center point of the reveal. Corner pieces can be manufactured for both inside and outside conditions. Custom leg lengths are available.

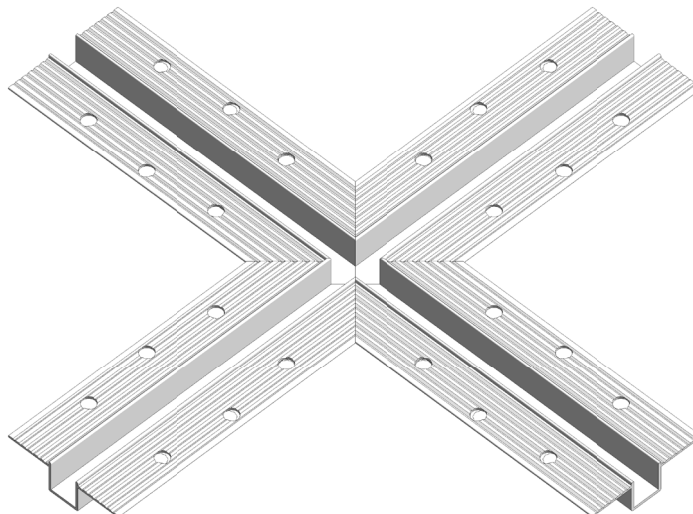
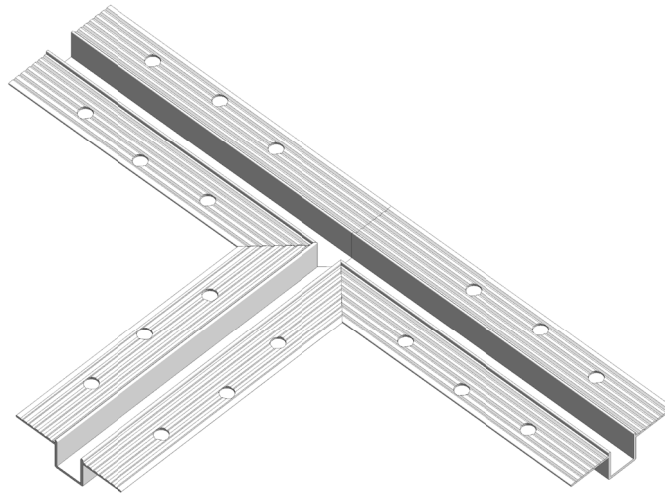



**DJ.3****END CAPS****INSTALLATION  
GUIDE**

End Caps are not available for all products; please consult a customer service representative.

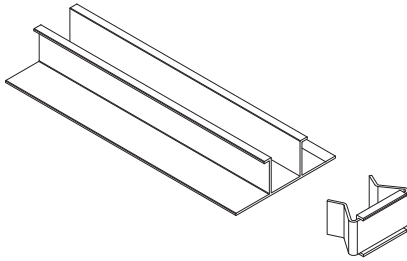
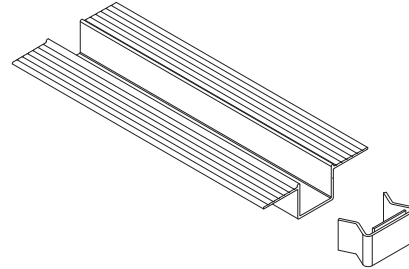
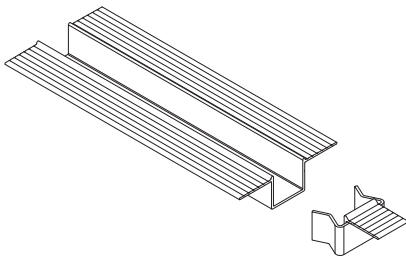
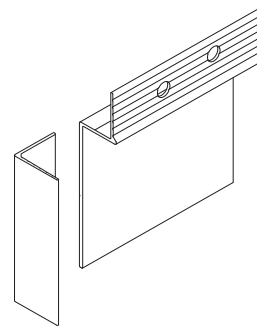
**PCS END CAP WITHOUT FLANGE****DRM END CAP WITHOUT FLANGE****DRM END CAP WITH TAPING FLANGE****DRMB WITH END CAP****CUTTING + FIELD PAINTING**

1. Materials can be cut with a chop saw, using a 96 tooth blade for non-ferrous metal.
2. Use a lubricant (WD-40 or grease stick) on the blade prior to cutting. Do not use an abrasive cut-off wheel.
3. Be sure to clean lubricant off trim.

If field painting of clear anodized moldings is the only alternative, the following steps must be taken to improve the bonding of the paint to the metal surface:

- Clean and treat material with an acid etch solution e.g. mild concentration of muriatic acid, rinse thoroughly and dry.
- Use a primer recommended by the manufacturer of the paint to be used.
- Apply coating following manufacturer's specifications.

However, Fry Reglet cannot accept responsibility for performance of field applied coatings over anodized finishes.

## DJ.4

## VENTILATION

### VENTING INFORMATION

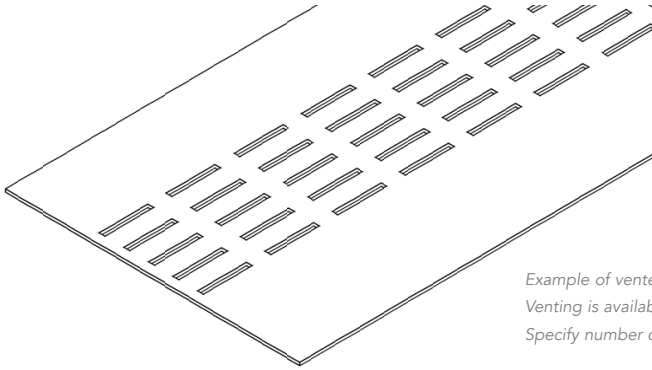

Example of vented profile with five rows of slots shown. Venting is available in one row of slots up to five rows. Specify number of rows required on your order.

### USAGE

Moldings requiring venting are provided with vents for air movement. In size charts they are identified with a "V" in the center of the product number.

### GUIDE SPECIFICATION

All vent slots are 1/8" wide by 1" long, spaced 1 1/2" on center lengthwise. Multiple rows are spaced laterally 1/2" on center. Each row of vent slots lengthwise provides approximately one square inch of vented area per lineal foot.

## VENTILATION INFORMATION

REVEAL WIDTH	VENT SLOT	VENT AREA PER LINEAL FOOT APPROX.	PERCENT OF AREA VENTED APPROX.
1/2"	1	1 sq. inch	15.0%
3/4"	1	1 sq. inch	12.5%
7/8"	1	1 sq. inch	9.5%
1"	1	1 sq. inch	9.4%
1 1/8"	1	1 sq. inch	8.3%
1 1/2"	2	2 sq. inch	12.5%
2"	3	3 sq. inch	14.1%
2 1/2"	3	3 sq. inch	11.3%
3"	5	5 sq. inch	14.3%
4"	5	5 sq. inch	10.4%
6"	8	8 sq. inch	12.5%

## CONTENTS

## P Plaster + E.I.F.S Moldings











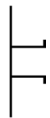
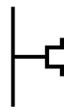
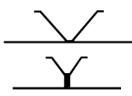
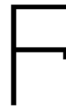
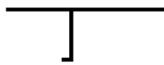

<b>REVEALS AND CHANNEL SCREED /CONTROL JOINTS</b>	<b>PA</b>	<b>PA.1</b>	Channel Screed/Control Joint	<b>PF</b> <b>TRIMS</b>	<b>PF.1</b>	Fascia Corner Molding	
	<b>PA.2</b>	¼" Channel Screed/Control Joint	<b>PF.2</b>		"J" Molding		
	<b>PA.3</b>	"V" Reveal Molding/Control Joint	<b>PG</b> <b>CORNERS</b>		<b>PG.1</b>	"X" Corner Molding	
	<b>PA.4</b>	"F" Reveal Molding			<b>PG.2</b>	Corner Key	
	<b>PA.5</b>	"T" Reveal Molding			<b>PH</b> <b>E.I.F.S.</b> <b>MATERIALS</b>	<b>PH.1</b>	E.I.F.S. Channel Screed
	<b>PA.6</b>	Plaster Key Reveal Molding				<b>PH.2</b>	E.I.F.S. Soffit Vent
	<b>PA.7</b>	Reveal Molding				<b>PH.3</b>	Clean Finish E.I.F.S. Soffit Vent
<b>COLUMN COLLARS</b>	<b>PB</b>	<b>PB.1</b>	Column Collar	<b>PI</b> <b>VENEER PLASTER</b>	<b>PH.4</b>	E.I.F.S. Soffit Vent Direct Applied)	
	<b>PB.2</b>	Column Collar	<b>PH.5</b>		E.I.F.S. Soffit Vent		
<b>DRIP SCREEDS</b>	<b>PC</b>	<b>PC.1</b>	7/8" Variable Fascia Drip Screed		<b>PH.6</b>	Soffit Vented E.I.F.S.	
		<b>PC.2</b>	7/8" Fascia Drip Screed		<b>PI.1</b>	Veneer Plaster Reveal	
		<b>PC.3</b>	¾" Fascia Drip Screed			<b>PI.2</b>	Veneer Plaster "F" Reveal
		<b>PC.4</b>	5/8" Fascia Drip Screed			<b>PI.3</b>	Veneer Plaster "Z" Reveal
		<b>PC.5</b>	¾" Fascia Drip Screed			<b>PI.4</b>	Contemporary Reveal
		<b>PC.6</b>	Soffit Molding		<b>PJ</b> <b>INSTALLATION</b>	<b>PJ.1</b>	Ventilation Information
		<b>PC.7</b>	"F" Drip Cap	<b>PJ.2</b>		Lathing - Vertical Installation	
		<b>PC.8</b>	Foundation Weep Screed	<b>PJ.3</b>		Lathing - Horizontal Installation	
<b>PLASTER/STUCCO EXPANSION SCREED</b>	<b>PD</b>	<b>PD.1</b>	2-Piece Plaster Expansion Screed	<b>PJ.4</b>		2 Piece Plaster Expansion Screed	
		<b>PE</b> <b>SOFFIT VENTS</b>	<b>PE.1</b>	7/8" Soffit Vent	<b>PJ.5</b>	Factory Fabricated Intersections	
			<b>PE.2</b>	¾" Soffit Vent	<b>PJ.6</b>	Factory Fabricated Intersections	
			<b>PE.3</b>	5/8" Soffit Vent	<b>PJ.7</b>	Factory Fabricated Intersections	
			<b>PE.4</b>	7/8" Variable Soffit Vent	<b>PJ.8</b>	Factory Fabricated Intersections	
			<b>PE.5</b>	Ceiling Soffit Vent	<b>PJ.9</b>	Factory Fabricated Intersections	
			<b>PE.6</b>	Perimeter Soffit Molding	<b>PJ.10</b>	Curved Moldings	
<b>PE.7</b>	Soffit Vent E.I.F.S.		<b>PK</b> <b>FINISHES</b>	<b>PK.1</b>	Finishes		
		<b>PK.2</b>		Finishes			
		<b>PK.3</b>		Finishes			

## SHAPE FINDER INDEX

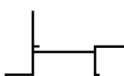
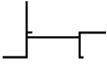
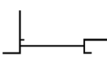
# P Plaster + E.I.F.S Moldings

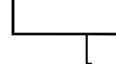



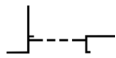
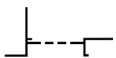





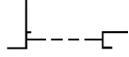

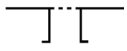





### GUIDE SPECIFICATION

Where indicated on drawings, Fry Reglet reveals and moldings, as manufactured by Fry Reglet Corporation, shall be installed. Fry Reglet aluminum reveals and moldings shall be extruded alloy 6063 T5, with chemical conversion coating, primed finish, clear anodized or other specified finish. Refer to finish section.

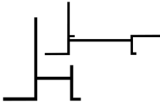
<b>PA.1</b> CHANNEL SCREED /CONTROL JOINT 	<b>PA.2</b> 1/4" CHANNEL SCREED /CONTROL JOINT 	<b>PA.3</b> "V" REVEAL MOLDING /CONTROL JOINT 	<b>PA.4</b> "F" REVEAL MOLDING 	<b>PA.5</b> "T" REVEAL MOLDING 
<b>PA.6</b> PLASTER KEY REVEAL MOLDING 	<b>PA.7</b> REVEAL MOLDING 	<b>PB.1</b> COLUMN COLLAR 	<b>PB.2</b> COLUMN COLLAR 	<b>PC.1</b> DRIP SCREED 
<b>PC.2</b> STUCCO DRIP SCREED 	<b>PC.3</b> 3/4" FASCIA DRIP SCREED 	<b>PC.4</b> 5/8" FASCIA DRIP SCREED 	<b>PC.5</b> 3/8" FASCIA DRIP SCREED 	<b>PC.6</b> SOFFIT MOLDING 
<b>PC.7</b> "F" DRIP CAP 	<b>PC.8</b> FOUNDATION WEEP SCREED 	<b>PD.1</b> 2-PIECE PLASTER EXPANSION SCREED 	<b>PE.1</b> 7/8" SOFFIT VENT 	<b>PE.2</b> 3/4" SOFFIT VENT 

SHAPE FINDER INDEX

**P** Plaster + E.I.F.S Moldings

<b>PE.3</b>	<b>PE.4</b>	<b>PE.5</b>	<b>PE.6</b>	<b>PF.1</b>
5/8" SOFFIT VENT	7/8" VARIABLE SOFFIT VENT	CEILING SOFFIT VENT	PERIMETER SOFFIT MOLDING	FASCIA CORNER MOLDING
				
<b>PF.2</b>	<b>PG.1</b>	<b>PG.2</b>	<b>PH.1</b>	<b>PH.2</b>
"J" MOLDING	INSIDE / OUTSIDE "X" CORNER MOLDING	CORNER KEY	E.I.F.S. CHANNEL SCREED	E.I.F.S. SOFFIT VENT
				
<b>PH.3</b>	<b>PH.4</b>	<b>PH.5</b>	<b>PH.6</b>	<b>PH.7</b>
CLEANFINISH E.I.F.S. SOFFIT VENT	E.I.F.S. SOFFIT VENT (DIRECT APPLIED)	E.I.F.S. SOFFIT VENT	E.I.F.S. DRIP SCREED	SOFFIT VENTED E.I.F.S.
				
<b>PI.1</b>	<b>PI.2</b>	<b>PI.3</b>	<b>PI.4</b>	
VENEER PLASTER REVEAL MOLDING	VENEER PLASTER "F" REVEAL MOLDING	VENEER PLASTER "Z" REVEAL MOLDING	CONTEMPORARY REVEAL MOLDING	
				

PA.1

PRODUCT DETAIL

INSTALLATION DETAIL / Cross Section

CHANNEL SCREED  
/CONTROL JOINT

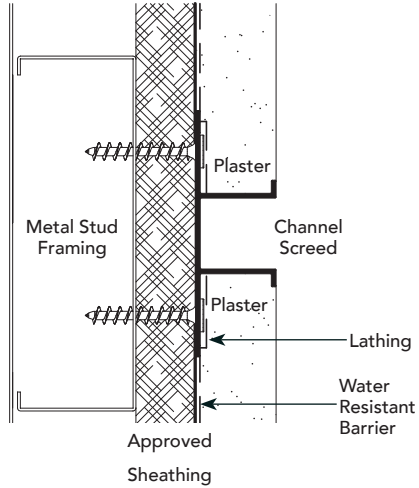
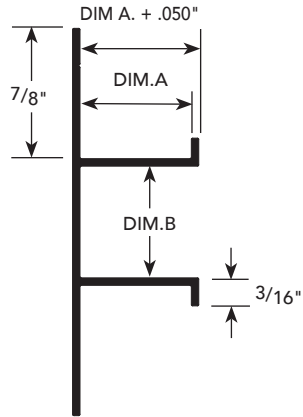

DIM. A REVEAL DEPTH	DIM. B REVEAL WIDTH	NUMBER	
		NON-VENTED	VENTED
1/4"*	3/4"	PCS-125-75	PCS-125-V-75
1/4"*	1 1/2"	PCS-125-150	PCS-125-V-150
3/8"*	1/2"	PCS-375-50	PCS-375-V-50
3/8"*	3/4"	PCS-375-75	PCS-375-V-75
3/8"*	1"	PCS-375-100	PCS-375-V-100
3/8"*	1 1/2"	PCS-375-150	PCS-375-V-150
3/8"	3"	PCS-375-300	PCS-375-V-300
1/2"	1/2"	DCS-50-50	DCS-50-V-50
1/2"	3/4"	DCS-50-75	DCS-50-V-75
1/2"	1"	DCS-50-100	DCS-50-V-100
1/2"	1 1/2"	DCS-50-150	DCS-50-V-150
1/2"	2"	DCS-50-200	DCS-50-V-200
1/2"	3"	DCS-50-300	DCS-50-V-300
1/2"	4"	DCS-50-400	DCS-50-V-400
5/8"	1/2"	DCS-625-50	DCS-625-V-50
5/8"	3/4"	DCS-625-75	DCS-625-V-75
5/8"	1"	DCS-625-100	DCS-625-V-100
5/8"	1 1/2"	DCS-625-150	DCS-625-V-150

DIM. A REVEAL DEPTH	DIM. B REVEAL WIDTH	NUMBER	
		NON-VENTED	VENTED
5/8"	2"	DCS-625-200	DCS-625-V-200
5/8"	2 1/2"	DCS-625-250	DCS-625-V-250
5/8"	3"	DCS-625-300	DCS-625-V-300
5/8"	4"	DCS-625-400	DCS-625-V-400
5/8"	6"	DCS-625-600	DCS-625-V-600
3/4"	1/2"	PCS-75-50	PCS-75-V-50
3/4"	3/4"	PCS-75-75	PCS-75-V-75
3/4"	1"	PCS-75-100	PCS-75-V-100
3/4"	1 1/2"	PCS-75-150	PCS-75-V-150
3/4"	2"	PCS-75-200	PCS-75-V-200
3/4"	2 1/2"	PCS-75-250	PCS-75-V-250
3/4"	3"	PCS-75-300	PCS-75-V-300
3/4"	4"	PCS-75-400	PCS-75-V-400
3/4"	6"	PCS-75-600	PCS-75-V-600
1"	3/4"	PCS-100-75	PCS-100-V-75
1"	1"	PCS-100-100	PCS-100-V-100
1"	3"	PCS-100-300	PCS-100-V-300
1 1/2"	1 1/2"	PCS-150-150	PCS-150-V-150

\*For one-coat stucco systems  
Weep holes available upon request

**PA.2** PRODUCT DETAIL

INSTALLATION DETAIL / Cross Section

**1/4" CHANNEL  
SCREED  
/CONTROL JOINT**

REVEAL WIDTH + DEPTH	NUMBER
1/4"	PCS-75-25/25

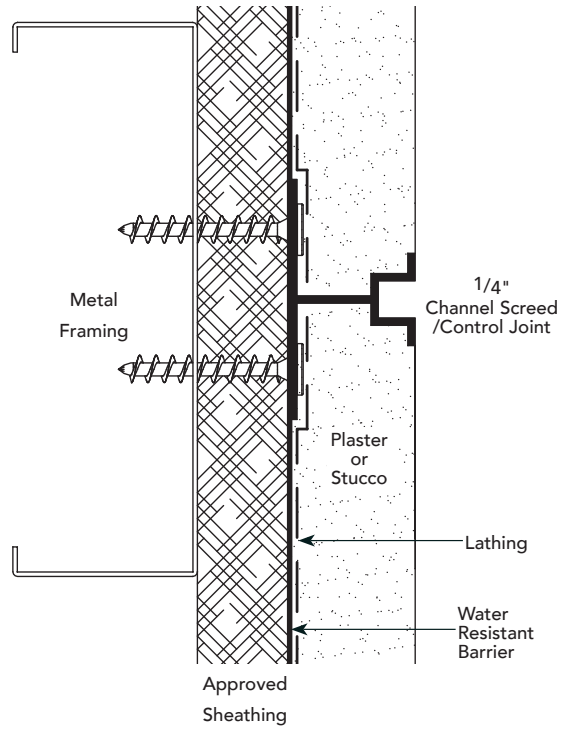
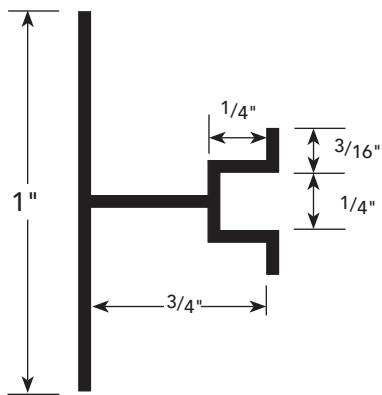

PA.3

PRODUCT DETAIL

INSTALLATION DETAIL / Cross Section

"V" REVEAL MOLDING /CONTROL JOINT

REVEAL DEPTH	REVEAL WIDTH	NUMBER
3/4"	1 1/2"	PCSV-75
5/16"	3/4"	PCSV-75-Short

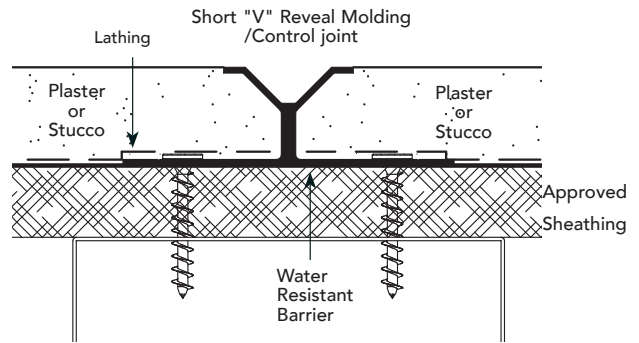
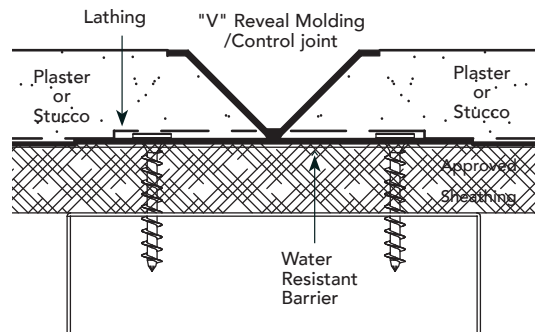
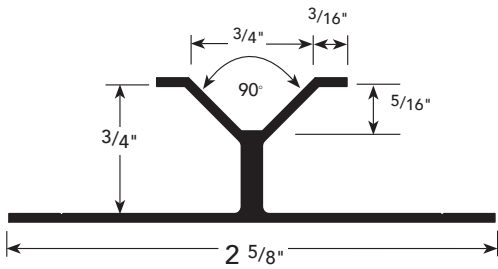
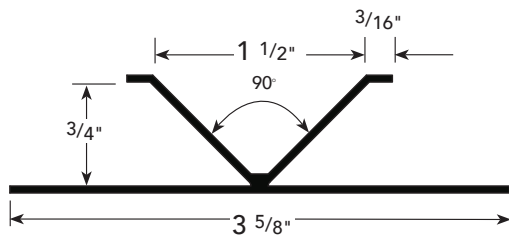



**PA.4** PRODUCT DETAIL

**"F" REVEAL MOLDING**

DIM. A REVEAL DEPTH	DIM. B REVEAL WIDTH	NUMBER	
		NON-VENTED	VENTED
3/8"	1/2"	FPM-375-50	FPM-375-V-50
1/2"	3/4"	FDM-50-75	FDM-50-V-75
5/8"	1/2"	FDM-625-50	FDM-625-V-50
5/8"	3/4"	FDM-625-75	FDM-625-V-75
5/8"	1"	FDM-625-100	FDM-625-V-100
5/8"	1 1/2"	FDM-625-150	FDM-625-V-150
5/8"	2 1/2"	FDM-625-250	FDM-625-V-250
5/8"	3"	FDM-625-300	FDM-625-V-300
3/4"	1/2"	FPM-75-50	FPM-75-V-50
3/4"	3/4"	FPM-75-75	FPM-75-V-75
3/4"	1"	FPM-75-100	FPM-75-V-100
3/4"	1 1/2"	FPM-75-150	FPM-75-V-150
3/4"	2"	FPM-75-200	FPM-75-V-200
3/4"	3"	FPM-75-300	FPM-75-V-300

Weep holes available upon request

INSTALLATION DETAIL / Cross Section

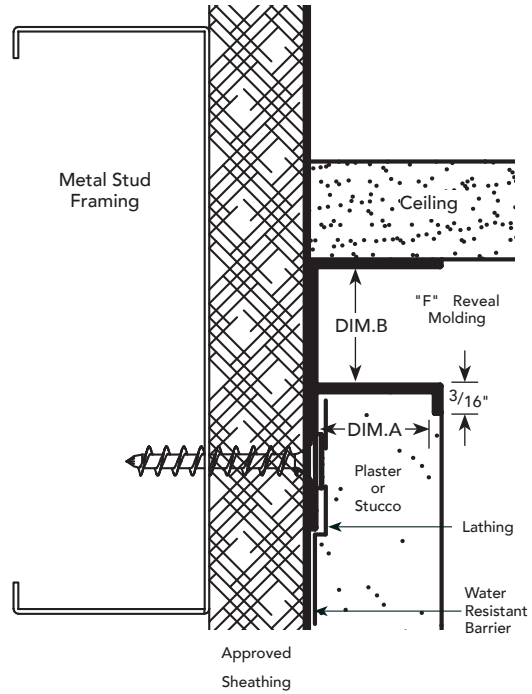

**PA.5** PRODUCT DETAIL

**"T" REVEAL MOLDING**

PLASTER THICKNESS	DIM. B REVEAL WIDTH	NUMBER	
		NON-VENTED	VENTED
3/4"	3/4"	TRM-75-75	TRM-75-V-75
3/4"	1 1/8"	TRM-75-1125	TRM-75-V-1125
3/4"	1 1/2"	TRM-75-150	TRM-75-V-150

INSTALLATION DETAIL / Cross Section

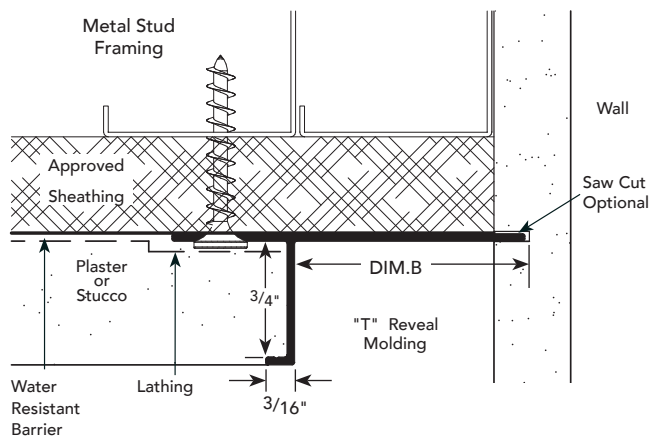

**PA.6**

**PRODUCT DETAIL**

**PLASTER KEY REVEAL MOLDING**

DIM. A REVEAL DEPTH	DIM. B REVEAL WIDTH	NUMBER	
		NON-VENTED	VENTED
3/4"	7/8"	PRZ-75-75	PRZ-75-V-75
1"	3/4"	PRZ-75-100	PRZ-75-V-100

**INSTALLATION DETAIL / Cross Section**

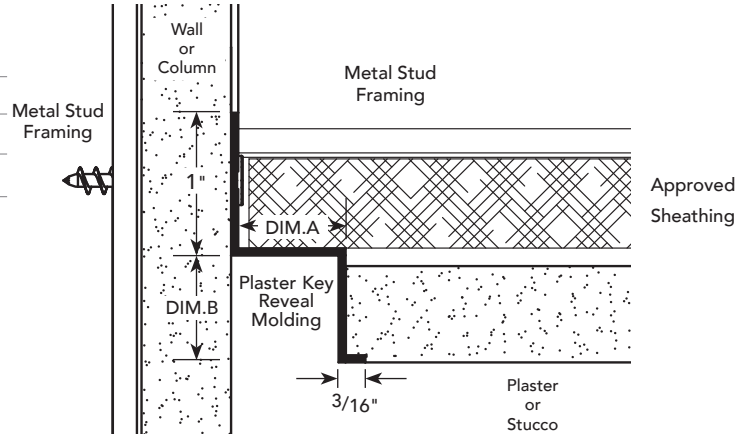

**PA.7**

**PRODUCT DETAIL**

**REVEAL MOLDING**

PLASTER THICKNESS	DIM. B REVEAL WIDTH	NUMBER	
		NON-VENTED	VENTED
3/4"	3/4"	PRM-75-75	PRM-75-V-75

For use with columns, curved sizes available to fit columns above 18" in diameter.

**INSTALLATION DETAIL / Cross Section**

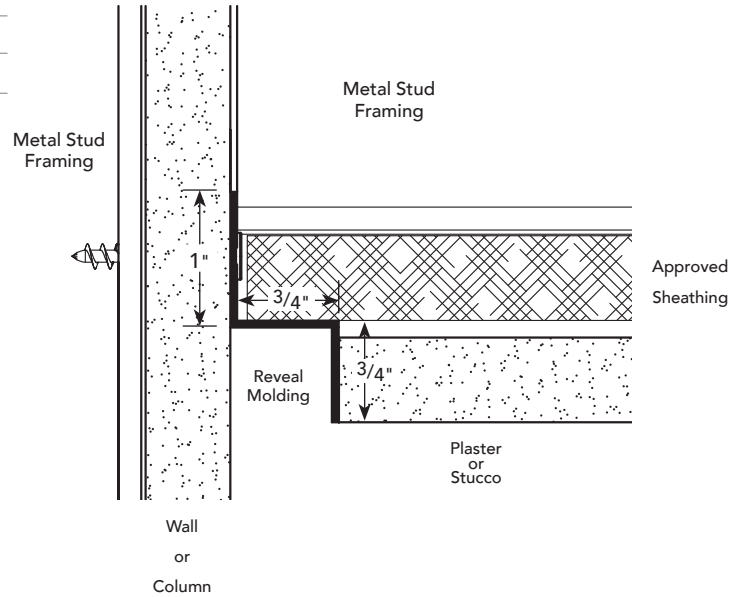

**PB.1**

**PRODUCT DETAIL**

**INSTALLATION DETAIL / Cross Section**

**COLUMN COLLAR**

**DRYWALL**

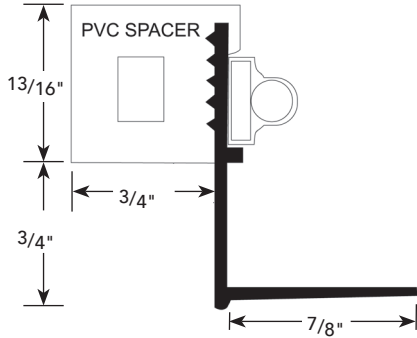

**ACOUSTICAL/DRYWALL**

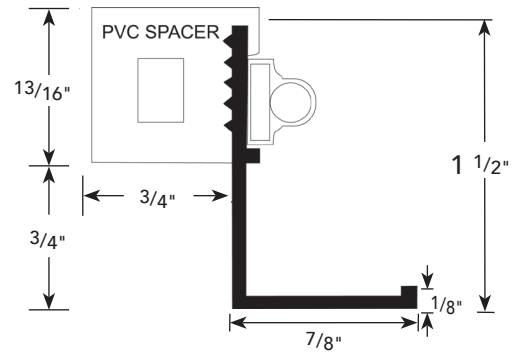

**PLASTER**

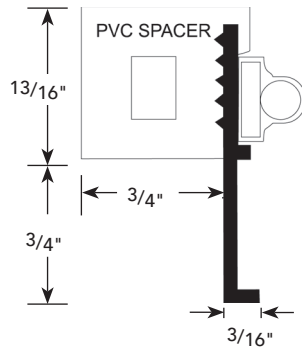

**USAGE**

Fry Reglet Column Collar provides a functional, attractive trim creating a reveal at column/ceiling joint. PVC spacer insures an attractive appearance and no light leaks. Fabricated to fit specific column sizes. Tightens in place with a turnbuckle and stainless steel metal band. Available with white or dark bronze PVC spacer. Finish is clear anodized, painted or finished with a chemical conversion coating for field painting.

**PB.2** INSTALLATION DETAIL / Cross Section

**COLUMN COLLAR**

**DRYWALL**

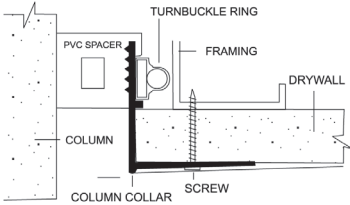

**PLASTER**

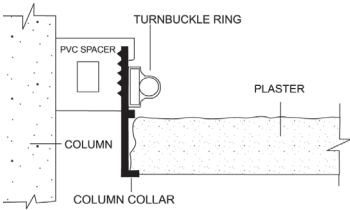

**ACOUSTICAL/DRYWALL**

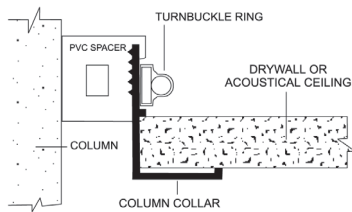

**SIZES**

Column covers are manufactured to fit specific columns from 10" to 48" in diameter.

**COMPONENTS**

**ADJUSTABLE BAND**

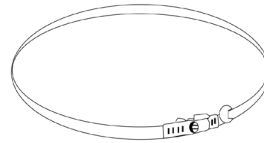

**ALUMINUM MOLDING**

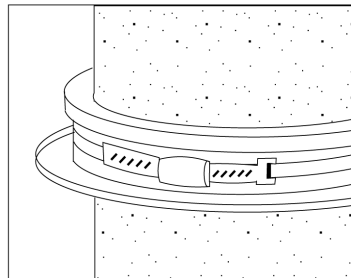
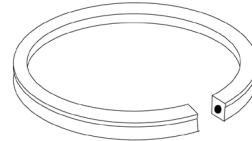
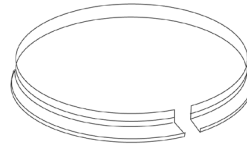

Three simple components secured by an adjustable band.

**USAGE**

Patented Fry Reglet Column Collar provides a functional, attractive trim creating a reveal at column/ceiling joint. PVC spacer insures an attractive appearance and no light leaks. Fabricated to fit specific column sizes. Tightens in place with a turnbuckle and stainless steel metal band. Available with white or dark bronze PVC spacer. Finish is clear anodized, painted or finished with a chemical conversion coating for field painting.

**PC.1** PRODUCT DETAIL

INSTALLATION DETAIL / Cross Section

**7/8" VARIABLE FASCIA DRIP SCREED**

**NUMBER**

NON-VENTED	VENTED
DS-875-875	DS-875-V-875

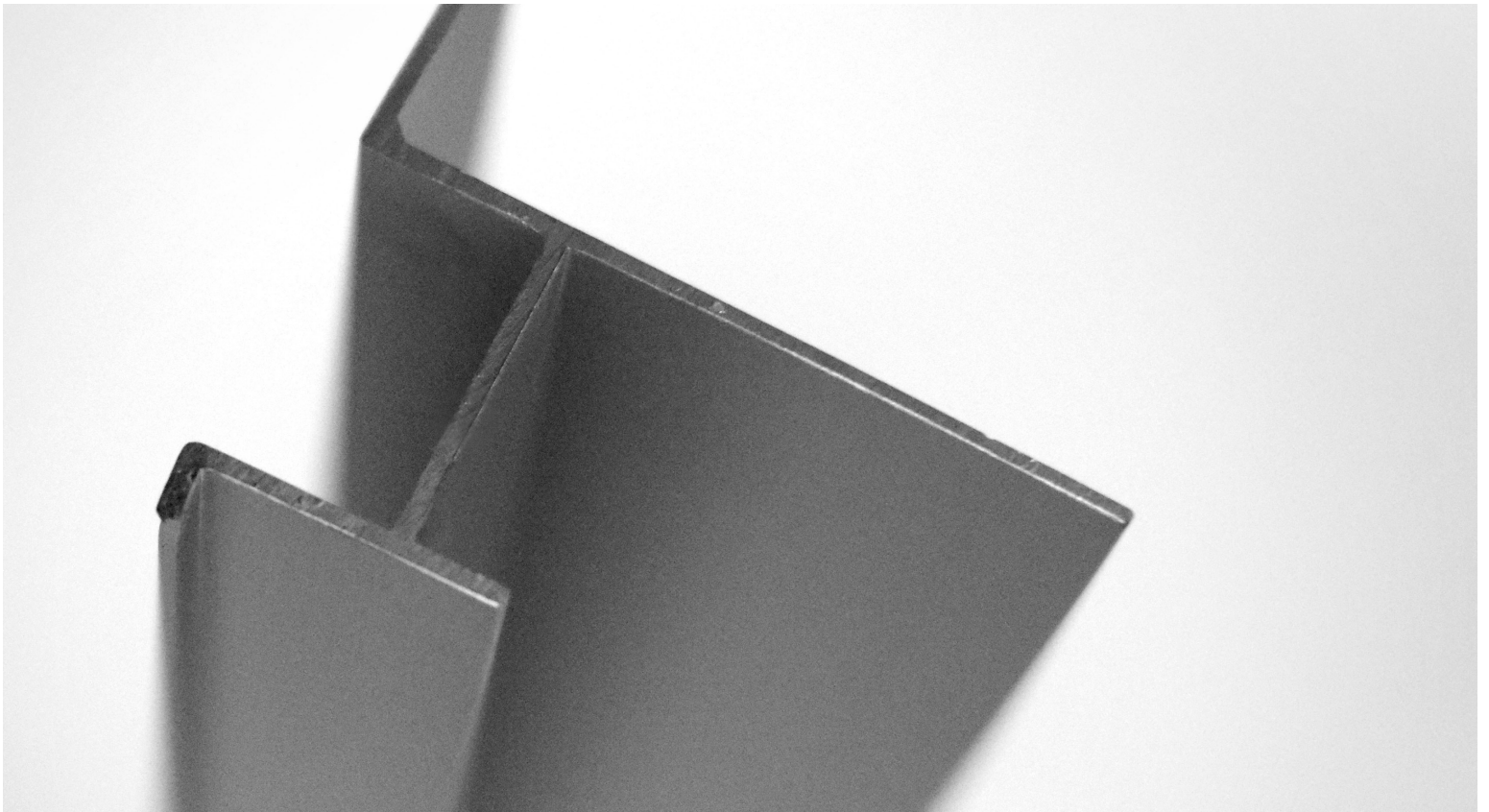
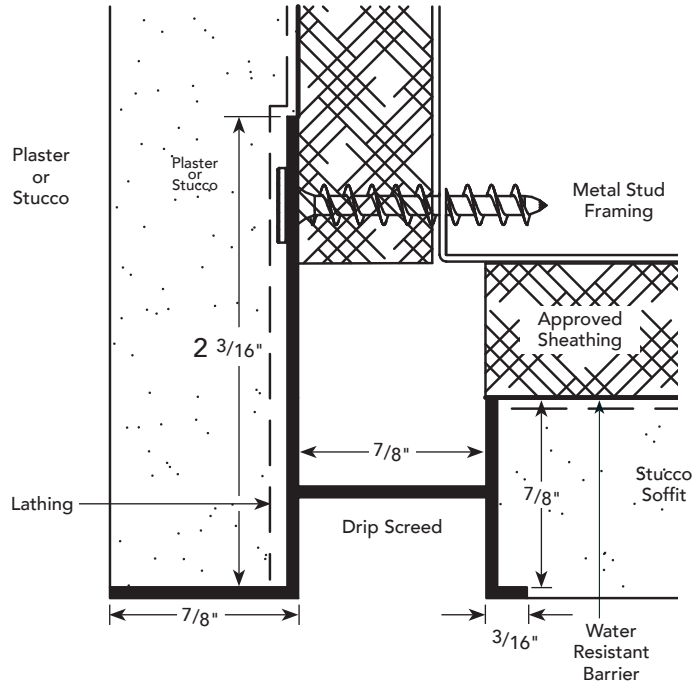

**PC.2**

**PRODUCT DETAIL**

**7/8" FASCIA  
DRIP SCREED**

DIM. A REVEAL WIDTH	NUMBER	
	NON-VENTED	VENTED
1 1/2"	DS-875-150	DS-875-V-150
2"	DS-875-200	DS-875-V-200
3"	DS-875-300	DS-875-V-300

**INSTALLATION DETAIL / Cross Section**

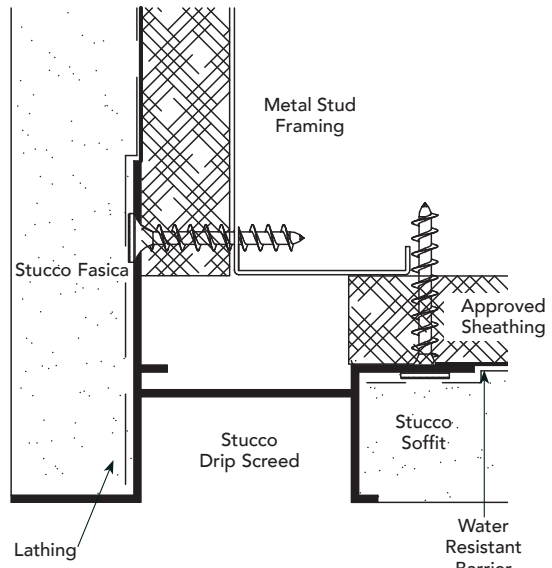

**DS-875-150**

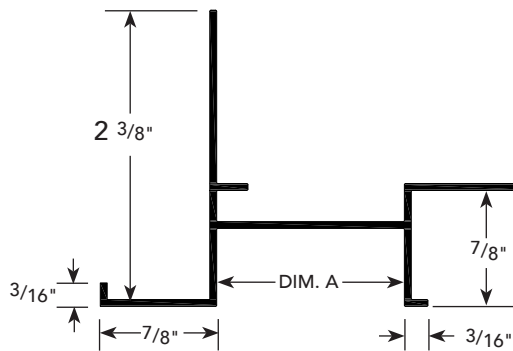

**DS-875-200  
DS-875-300**

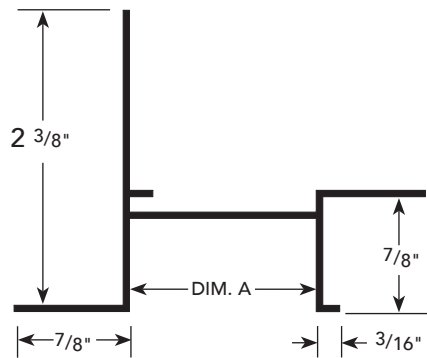

**PC.3** PRODUCT DETAIL

**3/4" FASCIA  
DRIP SCREED**

STUCCO THICKNESS	DIM. A REVEAL WIDTH	NUMBER	
		NON-VENTED	VENTED
3/4"	3/4"	DS-75-75	DS-75-V-75
3/4"	2"	DS-75-200	DS-75-V-200
3/4"	3"	DS-75-300	DS-75-V-300

INSTALLATION DETAIL / Cross Section

**DS-75-75**

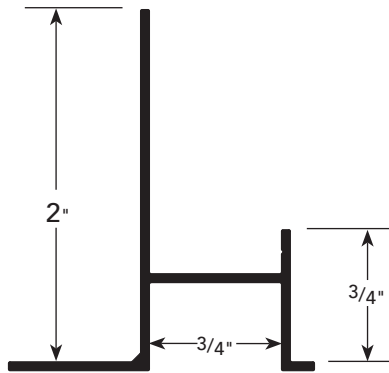

**DS-75-75**

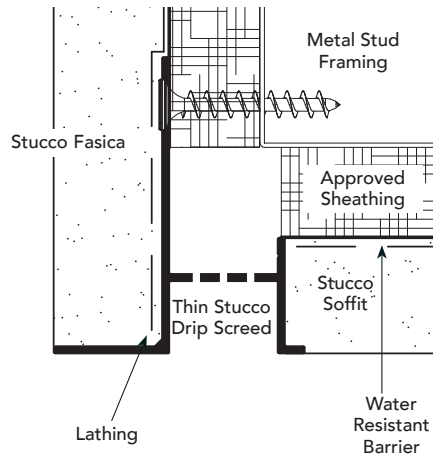

**DS-75-200/300  
(NOT TO SCALE)**

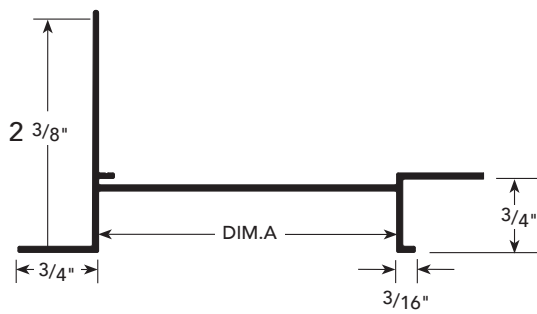

**DS-75-200/300**

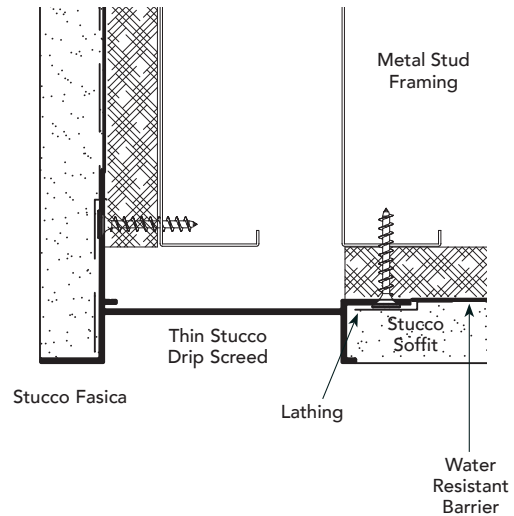

**PC.4** PRODUCT DETAIL

**5/8" DRIP SCREED**

REVEAL WIDTH	NUMBER	
	NON-VENTED	VENTED
3"	DS-875-5/8-300	DS-875-5/8-V-300

INSTALLATION DETAIL / Cross Section

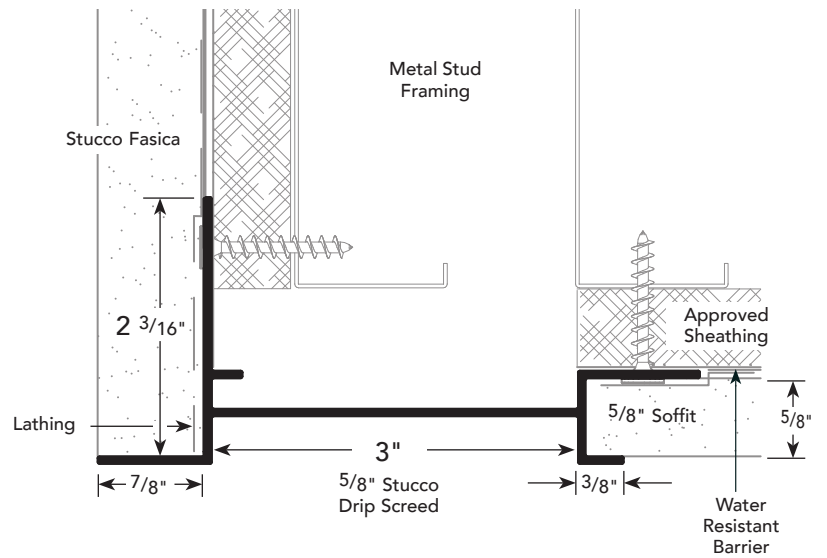

**PC.5** PRODUCT DETAIL

**3/8" FASCIA DRIP SCREED**

REVEAL WIDTH	NUMBER	
	NON-VENTED	VENTED
3/4"	DS-375-875	DS-375-V-875

INSTALLATION DETAIL / Cross Section

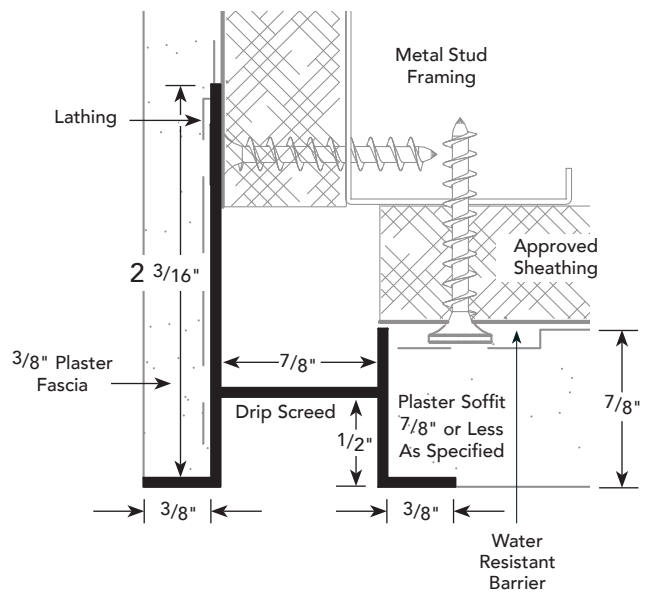



**PC.6** PRODUCT DETAIL

INSTALLATION DETAIL / Cross Section

**SOFFIT MOLDING**

DIM. B THICKNESS	DIM. A REVEAL WIDTH	DIM. C LEG WIDTH	NUMBER	
			NON-VENTED	VENTED
1/2"	3"	1/2"	WPM-50-300	WPM-50-V-300
3/4"	2"	3/16"	1680	1680-V
3/4"	3"	3/16"	WPM-75-300	WPM-75-V-300
3/4"	4"	3/16"	WPM-75-400	WPM-75-V-400

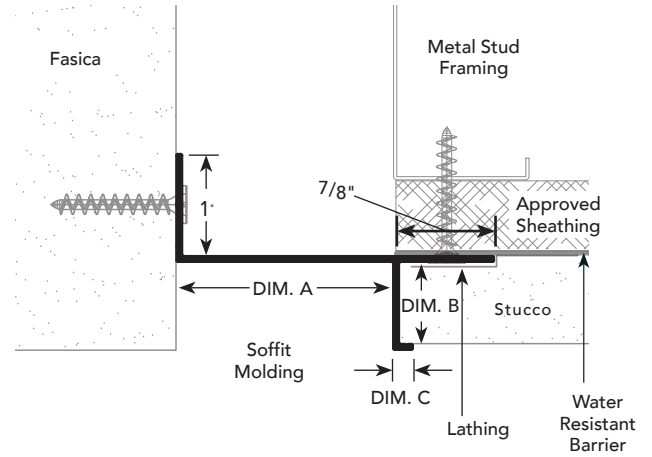

**PC.7** PRODUCT DETAIL

INSTALLATION DETAIL / Cross Section

**"F" DRIP CAP**

STUCCO DEPTH	REVEAL WIDTH	NUMBER
3/4"	3/4"	2221

Weep holes available upon request

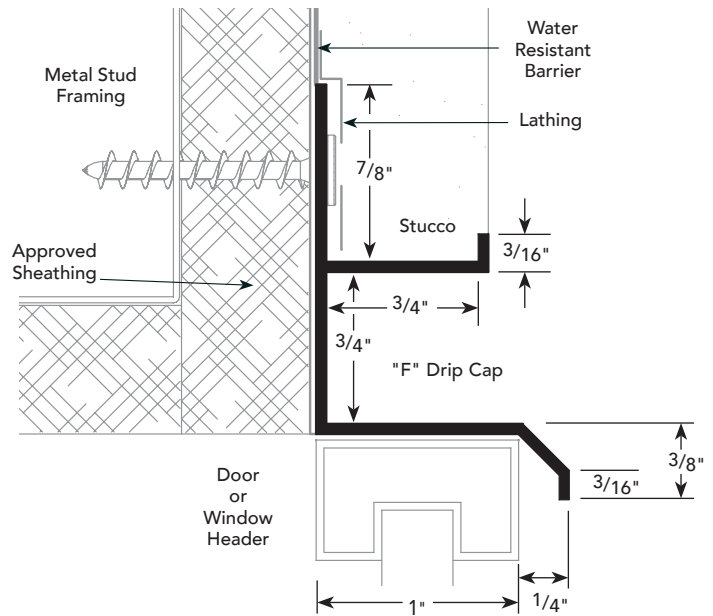

**PC.8** PRODUCT DETAIL

**FOUNDATION  
WEEP  
SCREED**

SCREED LENGTH	FLANGE DEPTH	NUMBER
3 3/8"	3/4"	FWS-75A (Aluminum)
3 3/8"	3/4"	FWS-75 (Vinyl)

INSTALLATION DETAIL / Cross Section

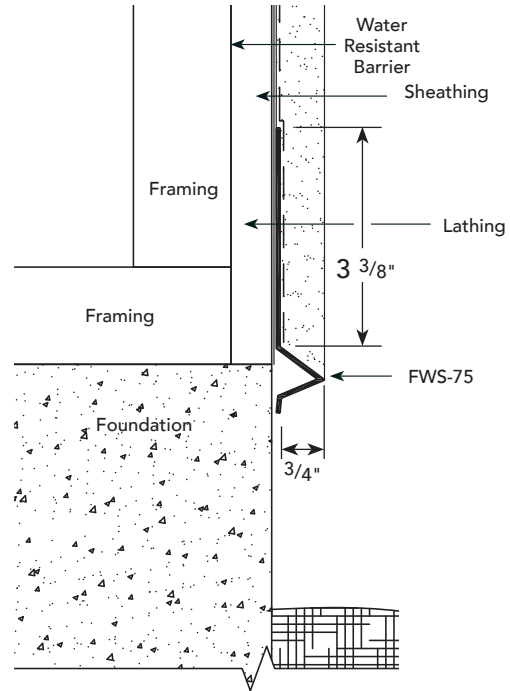

**PD.1** PRODUCT DETAIL

**2-PIECE PLASTER  
EXPANSION  
SCREED**

DIM. A	DIM. B REVEAL WIDTH	NUMBER
1/2"	3/4"	DCS-50-75 2-PC
1/2"	1 1/2"	DCS-50-150 2-PC
3/4"	1/4"	PCS-75-25 2-PC
3/4"	1/2"	PCS-75-50 2-PC
3/4"	3/4"	PCS-75-75 2-PC
3/4"	1"	PCS-75-100 2-PC
3/4"	1 1/2"	PCS-75-150 2-PC
3/4"	2"	PCS-75-200 2-PC

INSTALLATION DETAIL / Cross Section

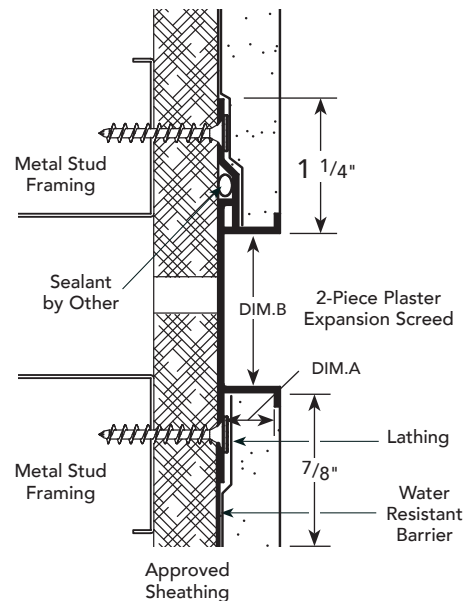

**PE.1** PRODUCT DETAIL

**7/8" SOFFIT VENT**

DIM. A REVEAL WIDTH	NUMBER
1 1/2"	DS-875-V-150
2"	DS-875-V-200
3"	DS-875-V-300

\*See page PJ-1 for data on number of vents and amount of vented area/sq. ft.

INSTALLATION DETAIL / Cross Section

**DS-875-150**

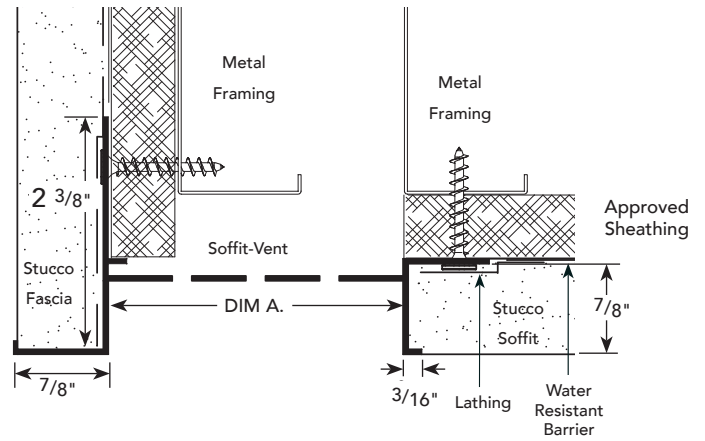

**PE.2** PRODUCT DETAIL

**3/4" SOFFIT VENT**

DIM. A REVEAL WIDTH	NUMBER
3/4"	DS-75-V-75
2"	DS-75-V-200
3"	DS-75-V-300

\*See page PJ-1 for data on number of vents and amount of vented area/sq. ft.

INSTALLATION DETAIL / Cross Section

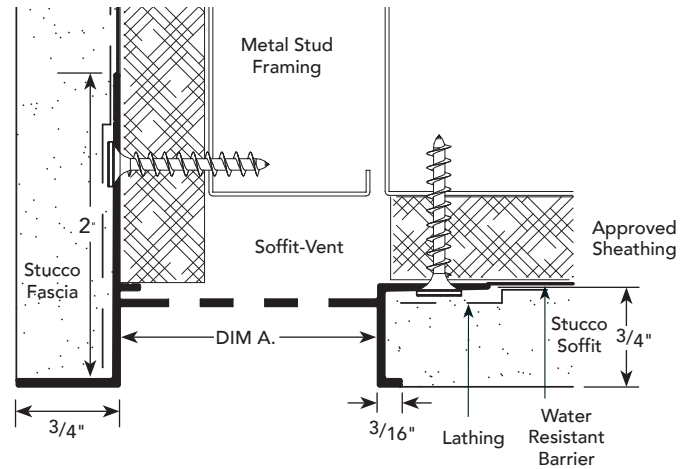

**PE.3** PRODUCT DETAIL

**5/8" SOFFIT VENT**

SOFFIT SUPPORT FLANGE	REVEAL WIDTH	NUMBER
5/8"	3"	DS-875-5/8-V-300

\*See page PJ-1 for data on number of vents and amount of vented area/sq. ft.

INSTALLATION DETAIL / Cross Section

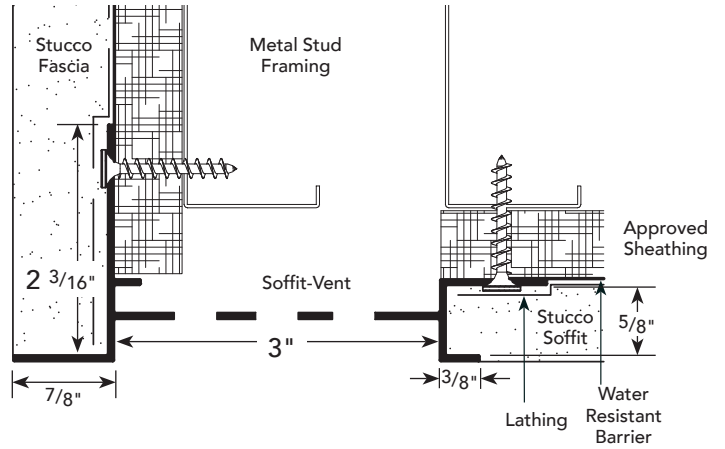

**PE.4** PRODUCT DETAIL

**7/8" VARIABLE SOFFIT VENT**

DIM. A REVEAL WIDTH	NUMBER
7/8"	DS-375-V-875

\*See page PJ-1 for data on number of vents and amount of vented area/sq. ft.

INSTALLATION DETAIL / Cross Section

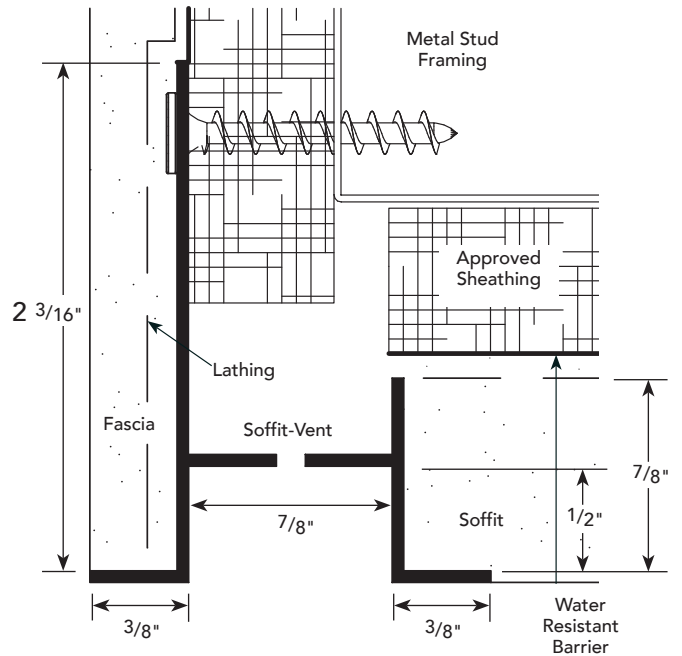

**PE.5**

**PRODUCT DETAIL**

**CEILING  
SOFFIT VENT**

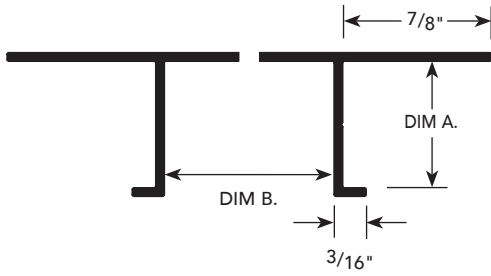

**INSTALLATION DETAIL / Cross Section**

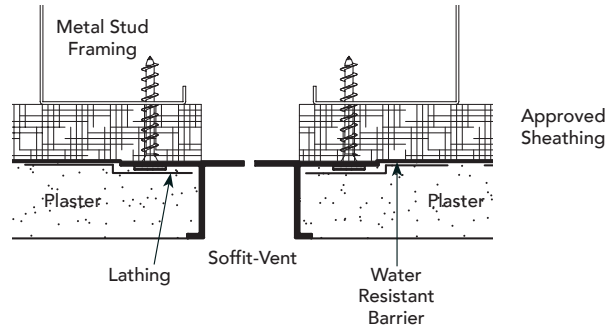

DIM. A PLASTER DEPTH	DIM. B REVEAL WIDTH	NUMBER
1/2"	1/2"	DCS-50-V-50
1/2"	3/4"	DCS-50-V-75
1/2"	1"	DCS-50-V-100
1/2"	1 1/2"	DCS-50-V-150
1/2"	2"	DCS-50-V-200
1/2"	3"	DCS-50-V-300
1/2"	4"	DCS-50-V-400
5/8"	1/2"	DCS-625-V-50
5/8"	3/4"	DCS-625-V-75
5/8"	1"	DCS-625-V-100
5/8"	1 1/2"	DCS-625-V-150
5/8"	2"	DCS-625-V-200
5/8"	2 1/2"	DCS-625-V-250
5/8"	3"	DCS-625-V-300
5/8"	4"	DCS-625-V-400
5/8"	6"	DCS-625-V-600
1/4"	3/4"	PCS-25-V-75

DIM. A PLASTER DEPTH	DIM. B REVEAL WIDTH	NUMBER
3/8"	1/2"	PCS-375-V-50
3/8"	3/4"	PCS-375-V-75
3/8"	1"	PCS-375-V-100
3/8"	1 1/2"	PCS-375-V-150
3/8"	3"	PCS-375-V-300
3/4"	1/2"	PCS-75-V-50
3/4"	3/4"	PCS-75-V-75
3/4"	1"	PCS-75-V-100
3/4"	1 1/2"	PCS-75-V-150
3/4"	2"	PCS-75-V-200
3/4"	2 1/2"	PCS-75-V-250
3/4"	3"	PCS-75-V-300
3/4"	4"	PCS-75-V-400
3/4"	6"	PCS-75-V-600
1"	3/4"	PCS-100-V-75
1"	1"	PCS-100-V-100
1"	3"	PCS-100-V-300
1 1/2"	1 1/2"	PCS-150-V-150

\*See page PJ-1 for data on number of vents and amount of vented areas/sq. ft.

**PE.6**

**PRODUCT DETAIL**

**PERIMETER SOFFIT MOLDING**

DIM. B. STUCCO DEPTH	DIM. A REVEAL WIDTH	DIM. C LEG WIDTH	NUMBER
1/2"	3"	1/2"	WPM-50-V-300
3/4"	2"	3/16"	1680-V
3/4"	3"	3/16"	WPM-75-V-300
3/4"	4"	3/16"	WPM-75-V-400

\*See page PJ-1 for data on number of vents and amount of vented area/sq. ft.

**INSTALLATION DETAIL / Cross Section**

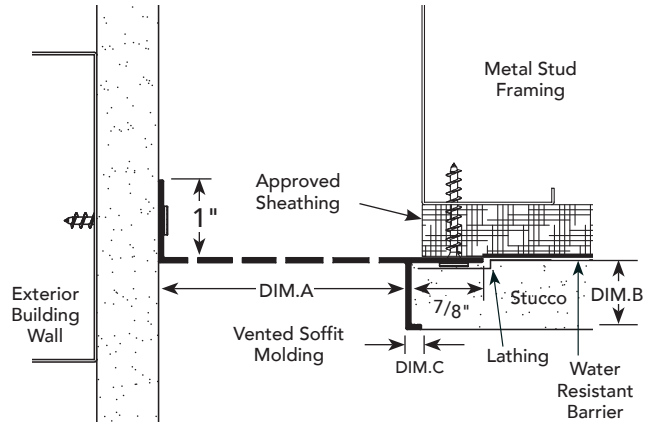

**PE.7**

**PRODUCT DETAIL**

**SOFFIT VENT E.I.F.S.**

VENT PATTERN*	NUMBER
5 Rows	VFS-600 Epoxy Gray
8 Rows	VFS-600 Epoxy Gray

\*Specify vent pattern when ordering.  
Vent Slots 1/8" wide by 1" long spaced 1 1/2" on center lengthwise.

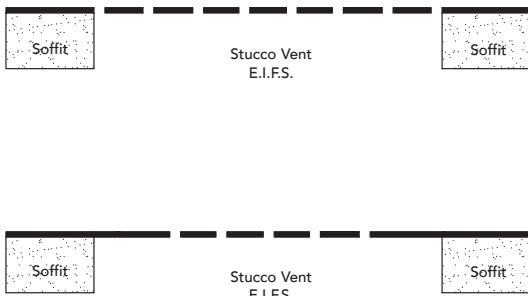

**INSTALLATION DETAIL / Cross Section**

**8 ROWS**

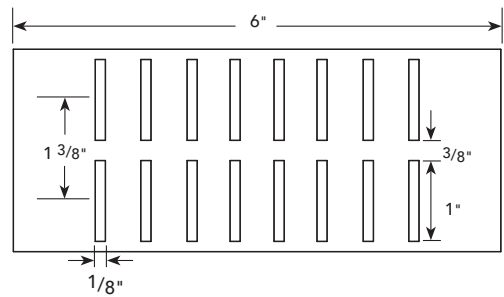

**5 ROWS**

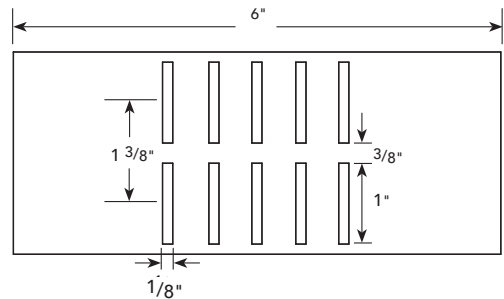

**PF.1** PRODUCT DETAIL

**FASCIA  
CORNER  
MOLDING**

DIM. A REVEAL WIDTH	DIM. A	DIM. B	NUMBER	APPLICATION
1 5/8"	5/8"	1/2"	FCM-50	DRYWALL
1 5/8"	3/4"	5/8"	FCM-75	PLASTER

INSTALLATION DETAIL / Cross Section

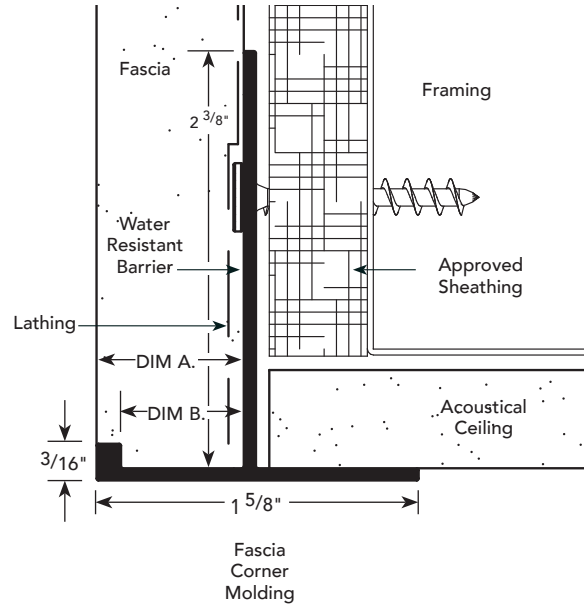

**PF.2** PRODUCT DETAIL

**"J" MOLDING**

DIM. A	DIM. B	DIM. C	NUMBER
1/2"	3/16"	1 1/8"	JDM-50
5/8"	3/16"	1 1/8"	JDM-625
3/4"	3/16"	1 1/8"	JPM-75
3/4"	3/16"	3"	JPM-75-300
1"	3/16"	1 1/8"	JPM-100

Weep holes available upon request

INSTALLATION DETAIL / Cross Section

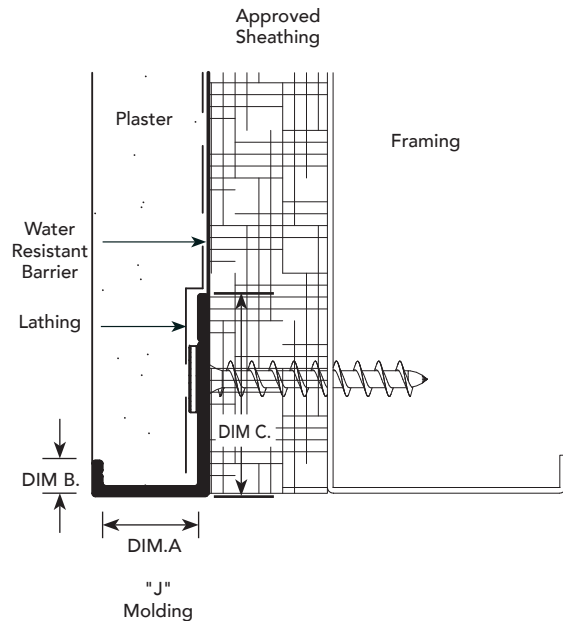

**PG.1** PRODUCT DETAIL

INSTALLATION DETAIL / Cross Section

**"X" CORNER MOLDING**

**XCM**

DIM. A REVEAL WIDTH	DIM. B REVEAL DEPTH	NUMBER
3/4"	7/8"	XCM-75-75
1/2"	7/8"	XDM-50-50
5/8"	7/8"	XDM-625-625
3/4"	1 1/2"	XCM-75-75-150

**PXM**

DIM. A REVEAL WIDTH	NUMBER
7/8"	PXM-75-75

**PIXM**

REVEAL WIDTH	NUMBER
3/4"	PIXM-75-75

**OUTSIDE CORNER**  
XCM-75-75  
XDM-50-50  
XDM-625-625  
XCM-75-75-150

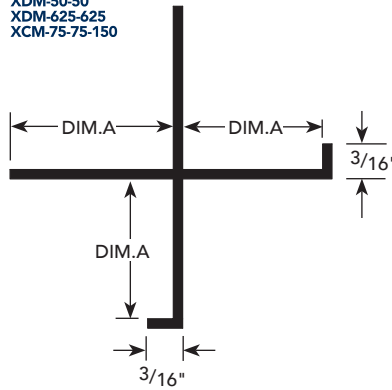

**OUTSIDE CORNER**  
PXM-75-75

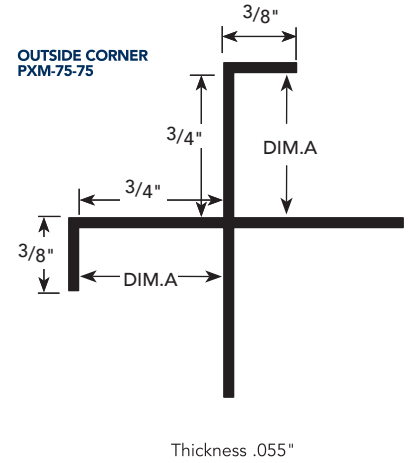

Thickness .055"

**INSIDE CORNER**  
PIXM-75-75

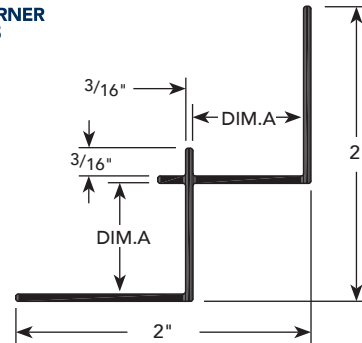

**PG.2** PRODUCT DETAIL

INSTALLATION DETAIL / Cross Section

**CORNER KEY**

NUMBER	DIM.
PCM-75-75	3/4"
PCM-75-75-150	1 1/2"

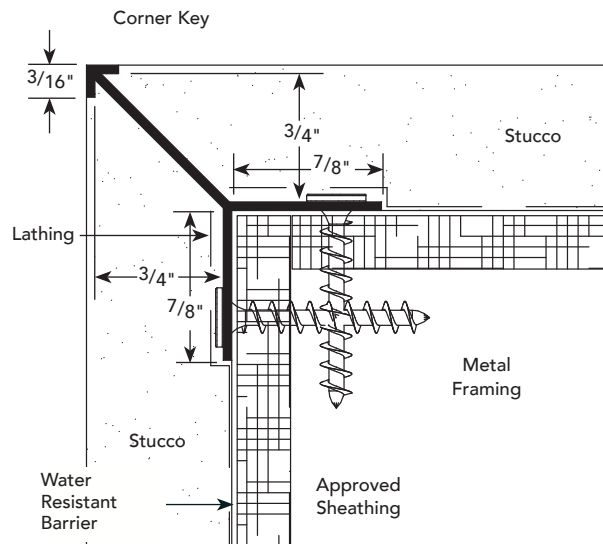



**PH.1** PRODUCT DETAIL

**E.I.F.S. CHANNEL SCREED**

DIM. A REVEAL WIDTH	NUMBER	
	NON-VENTED	VENTED
3/4"	PCS-125-75	PCS-125-V-75
1 1/2"	PCS-125-150	PCS-125-V-150

INSTALLATION DETAILS / Cross Section

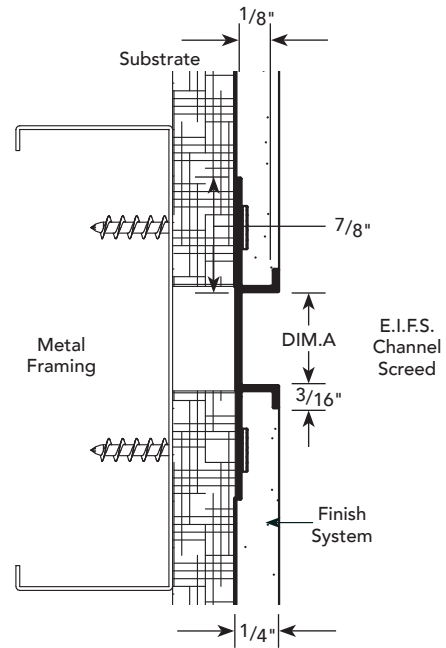

**PH.2** PRODUCT DETAIL

**E.I.F.S. SOFFIT VENT**

DIM. A	NUMBER
1/2"	PCS-75-V-50
3/4"	PCS-75-V-75
1"	PCS-75-V-100
1 1/2"	PCS-75-V-150
2"	PCS-75-V-200
2 1/2"	PCS-75-V-250
3"	PCS-75-V-300
4"	PCS-75-V-400
6"	PCS-75-V-600

INSTALLATION DETAILS / Cross Section

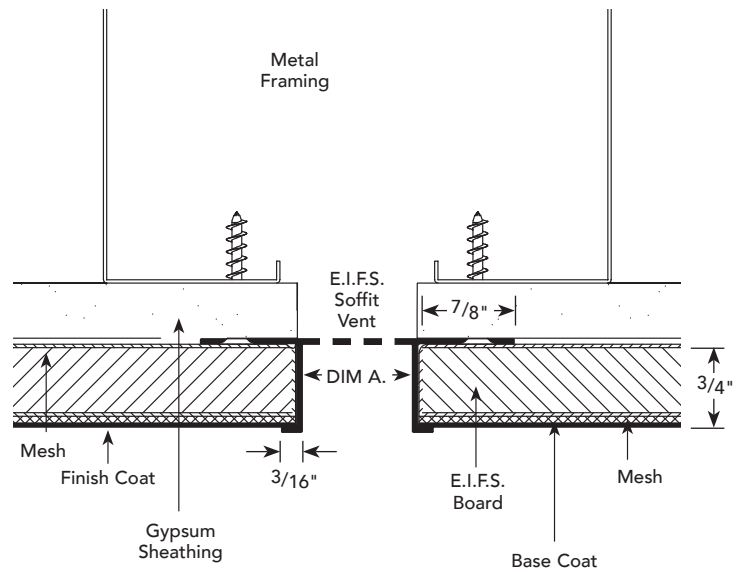

\*See page PJ-1 for data on number of vents and amount of vented area/sq. ft.

**PH.3**

**PRODUCT DETAIL**

**INSTALLATION DETAIL / Cross Section**

**CLEANFINISH  
E.I.F.S. SOFFIT  
VENT**

DIM. A	DIM. B	NUMBER	UNVENTED
1/2"	2"	SV-50-V-200/EIFS	SV-50-200/EIFS
1/2"	3"	SV-50-V-300/EIFS	SV-50-300/EIFS
1/2"	4"	SV-50-V-400/EIFS	SV-50-400/EIFS
3/4"	3"	SV-75-V-300/EIFS	SV-75-300/EIFS

\*See page PJ-1 for data on number of vents and amount of vented area/sq. ft.

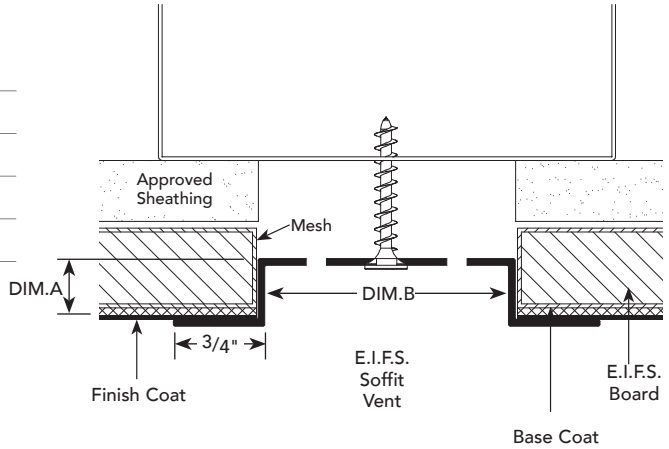

**PH.4**

**PRODUCT DETAIL**

**INSTALLATION DETAIL / Cross Section**

**E.I.F.S.  
SOFFIT VENT  
DIRECT APPLIED**

DIM. A	DIM. B REVEAL WIDTH	NUMBER
1/2"	1/2"	DRM-50-V-50
1/2"	5/8"	DRM-50-V-625
1/2"	3/4"	DRM-50-V-75
1/2"	1"	DRM-50-V-100
1/2"	1 1/2"	DRM-50-V-150
1/2"	2"	DRM-50-V-200
1/2"	2 1/2"	DRM-50-V-250
1/2"	3"	DRM-50-V-300
1/2"	4"	DRM-50-V-400

\*See page PJ-1 for data on number of vents and amount of vented area/sq. ft.

DIM. A	DIM. B REVEAL WIDTH	NUMBER
5/8"	1/2"	DRM-625-V-50
5/8"	5/8"	DRM-625-V-625
5/8"	3/4"	DRM-625-V-75
5/8"	1"	DRM-625-V-100
5/8"	1 1/4"	DRM-625-V-125
5/8"	1 1/2"	DRM-625-V-150
5/8"	2"	DRM-625-V-200
5/8"	2 1/2"	DRM-625-V-250
5/8"	3"	DRM-625-V-300
5/8"	4"	DRM-625-V-400
5/8"	6"	DRM-625-V-600

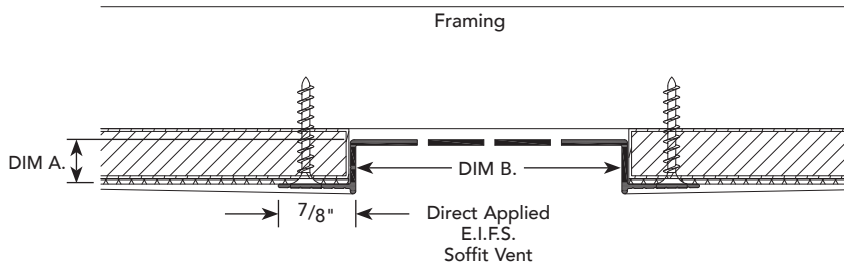

\*Denglass Gold, Durock, or other approved DEF substrate.

\*Refer to EIFS manufacturer for installation requirements

**PH.5 PRODUCT DETAIL**

**E.I.F.S. SOFFIT VENT**

VENT PATTERN*	NUMBER
	5 Rows
8 Rows	VFS-600 Epoxy Gray

\*Specify vent pattern when ordering.  
Vent Slots 1/8" wide by 1" long spaced 1 1/2" on center lengthwise.

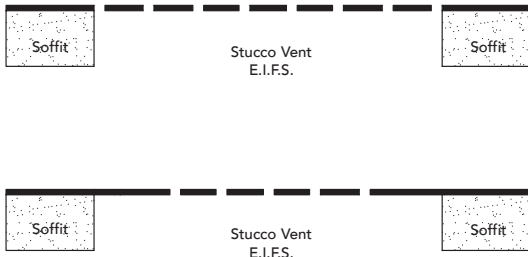

**INSTALLATION DETAILS / Cross Section**

**8 ROWS**

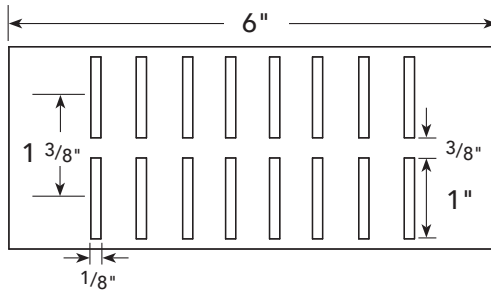

**5 ROWS**

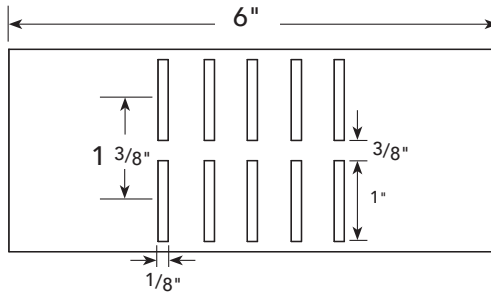

**PH.6 PRODUCT DETAIL**

**E.I.F.S. DRIP SCREED**

DIM. A REVEAL WIDTH	NUMBER	
	NON-VENTED	VENTED
3/4"	DS-75-75	DS-75-V-75
2"	DS-75-200	DS-75-V-200
3"	DS-75-300	DS-75-V-300

\*See page PJ-1 for data on number of vents and amount of vented area/sq. ft.

**INSTALLATION DETAILS / Cross Section**

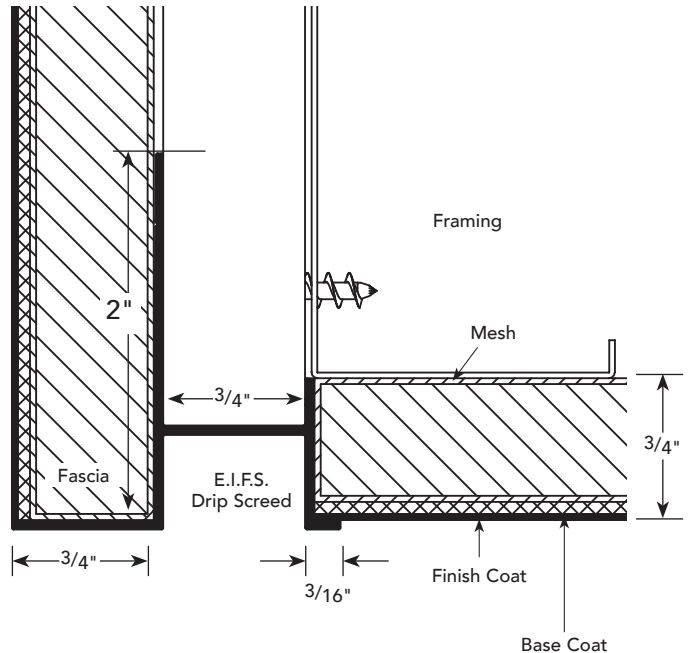

## VENEER PLASTER REVEALS SLEEK + SLIM.

Fry Reglet offers a selection of aluminum reveals and molding specifically designed for use with veneer plaster.

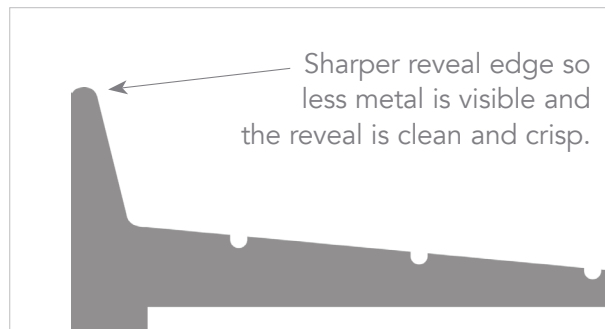
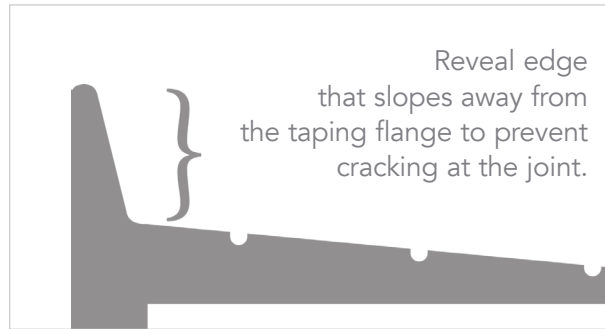
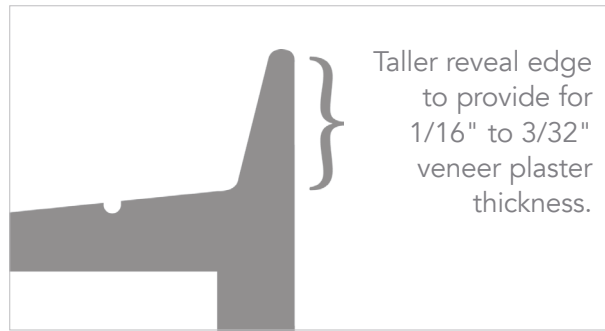

**PI.1** PRODUCT DETAIL

**VENEER PLASTER REVEAL MOLDING**

DIM. A	DIM. B	NUMBER
3/8"	3/8"	VPR-375-375
1/2"	1/2"	VPR-50-50
1/2"	3/4"	VPR-50-75
1/2"	1 1/2"	VPR-50-150
5/8"	3/8"	VPR-625-375
5/8"	1/2"	VPR-625-50
5/8"	5/8"	VPR-625-625
5/8"	3/4"	VPR-625-75

INSTALLATION DETAIL / Cross Section

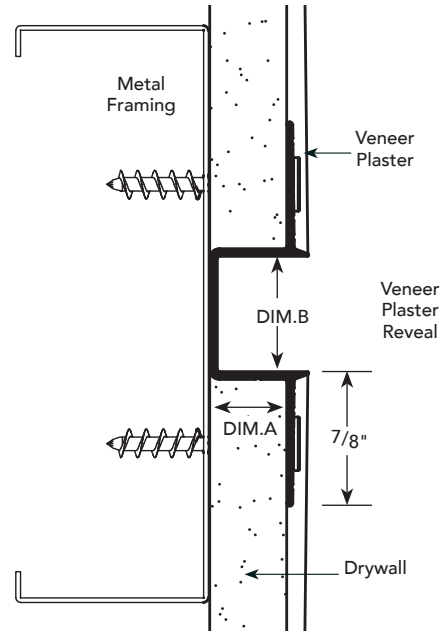

**PI.2** PRODUCT DETAIL

**VENEER PLASTER "F" REVEAL**

DIM. A REVEAL DEPTH	DIM. B REVEAL WIDTH	NUMBER
3/8"	3/8"	VPRF-375-375
1/2"	1/2"	VPRF-50-50
1/2"	3/4"	VPRF-50-75
5/8"	3/8"	VPRF-625-375
5/8"	1/2"	VPRF-625-50
5/8"	5/8"	VPRF-625-625
5/8"	3/4"	VPRF-625-75

INSTALLATION DETAIL / Cross Section

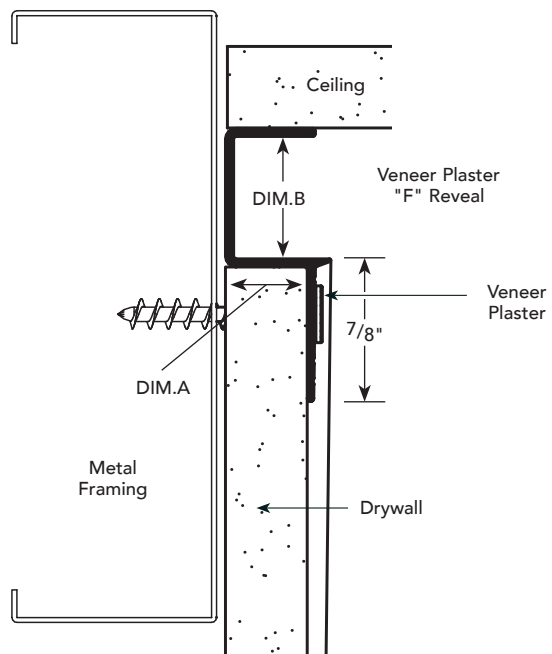

**PI.3**

**PRODUCT DETAIL**

**INSTALLATION DETAIL / Cross Section**

**VENEER PLASTER  
"Z" REVEAL**

DIM. A REVEAL DEPTH	DIM. B REVEAL WIDTH	NUMBER
3/8"	3/8"	VPRZ-375-375
1/2"	1/2"	VPRZ-50-50
1/2"	3/4"	VPRZ-50-75
5/8"	3/8"	VPRZ-625-375
5/8"	1/2"	VPRZ-625-50
5/8"	5/8"	VPRZ-625-625
5/8"	3/4"	VPRZ-625-75

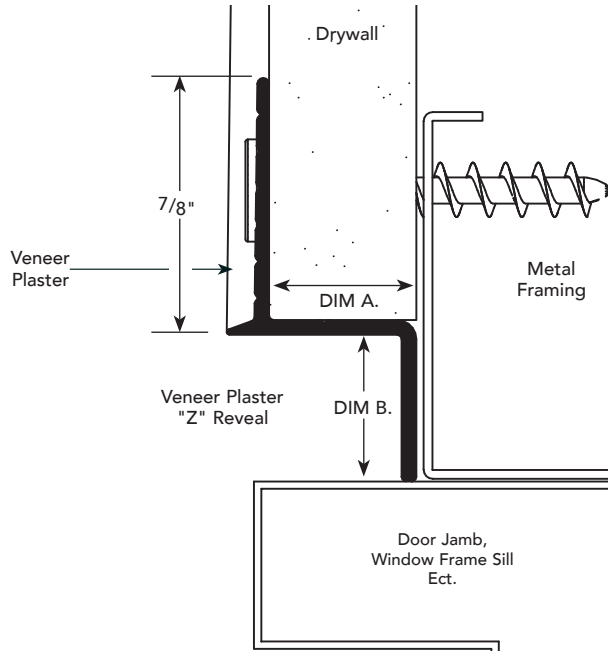

**PI.4**

**PRODUCT DETAIL**

**INSTALLATION DETAIL / Cross Section**

**CONTEMPORARY  
REVEAL**

DIM. A REVEAL DEPTH	DIM. B REVEAL WIDTH	NUMBER
1/2"	1/2"	CVPR-50-50
1/2"	5/8"	CVPR-50-625
1/2"	3/4"	CVPR-50-75
1/2"	1"	CVPR-50-100
5/8"	1/2"	CVPR-625-50
5/8"	5/8"	CVPR-625-625
5/8"	3/4"	CVPR-625-75
5/8"	1"	CVPR-625-100

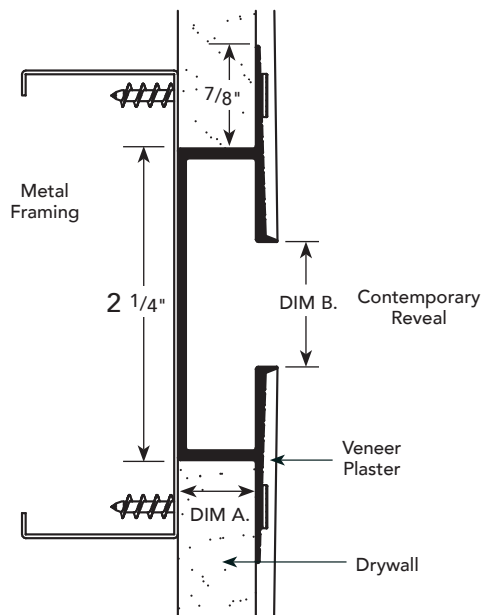

U.S. Patent No. 452,016

**PJ.1** PRODUCT DETAIL

INSTALLATION DETAIL / Cross Section

**VENTILATION INFORMATION**

REVEAL WIDTH	VENT SLOT	VENT AREA PER LINEAL FOOT APPROX.	PERCENT OF AREA VENTED APPROX.
1/2"	1	1 sq. inch	15.0%
3/4"	1	1 sq. inch	12.5%
7/8"	1	1 sq. inch	9.5%
1"	1	1 sq. inch	9.4%
1 1/8"	1	1 sq. inch	8.3%
1 1/2"	2	2 sq. inch	12.5%
2"	3	3 sq. inch	14.1%
2 1/2"	3	3 sq. inch	11.3%
3"	5	5 sq. inch	14.3%
4"	5	5 sq. inch	10.4%
6"	8	8 sq. inch	12.5%

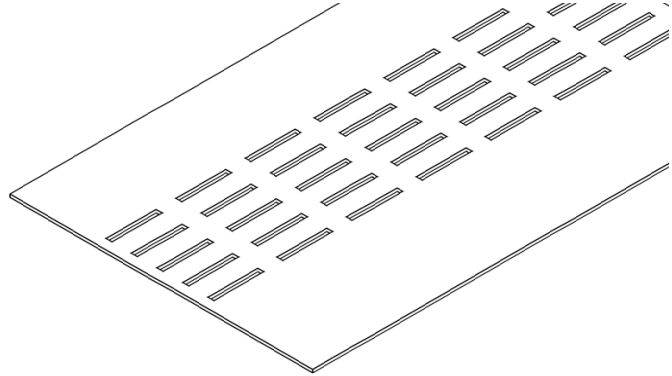

Example of vented profile with five rows of slots shown. Venting is available in one row of slots up to five rows. Specify number of rows required on your order.

**PJ.2** INSTALLATION

**LATHING VERTICAL INSTALLATION**

LATHING - VERTICAL INSTALLATION

1. Place building paper behind all moldings and shi lap a minimum of 6".
2. Secure moldings on 7" centers using fasteners as appropriate to substrate to meet ASTM C1063.
3. Install wire lath over installation flange of moldings.
4. Use vinyl or cloth tape specifically manufactured for masking anodized aluminum trim prior to plastering. For painted surfaces, use plastic tape.

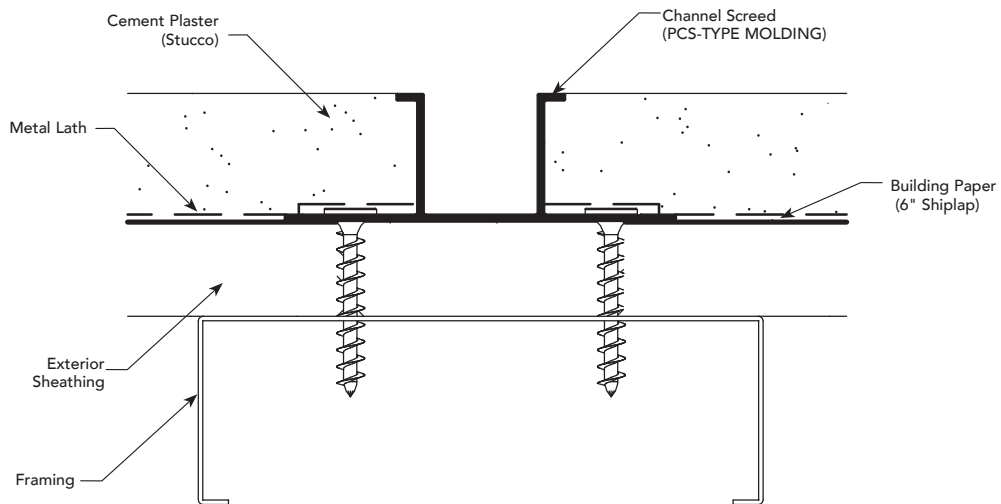

### PJ.3

## INSTALLATION

### LATHING HORIZONTAL INSTALLATION

#### LATHING - HORIZONTAL INSTALLATION

1. Place building paper behind all moldings and shi lap a minimum of 6".
2. Secure moldings on 16" centers using fasteners as appropriate to substrate.
3. Place building paper over upper flange of reveal, extending upward and under the above building paper overlap.
4. Place wire lath over upper installation flange on horizontal installation.
5. Install wire lath over bottom installation flange of moldings.
6. Use vinyl or cloth tape specifically manufactured for masking aluminum trim prior to plastering. For painted surfaces, use plastic tape.

#### INSTALLATION OF MOLDINGS AFTER BUILDING PAPER AND WIRE LATH HAVE BEEN INSTALLED

Make sure that the 7/8" installation flanges are covered with wire lath. This will prevent cracking.

Note: Uniform Building Code requires two layers of grade "D" paper when applied over wood base sheathing.

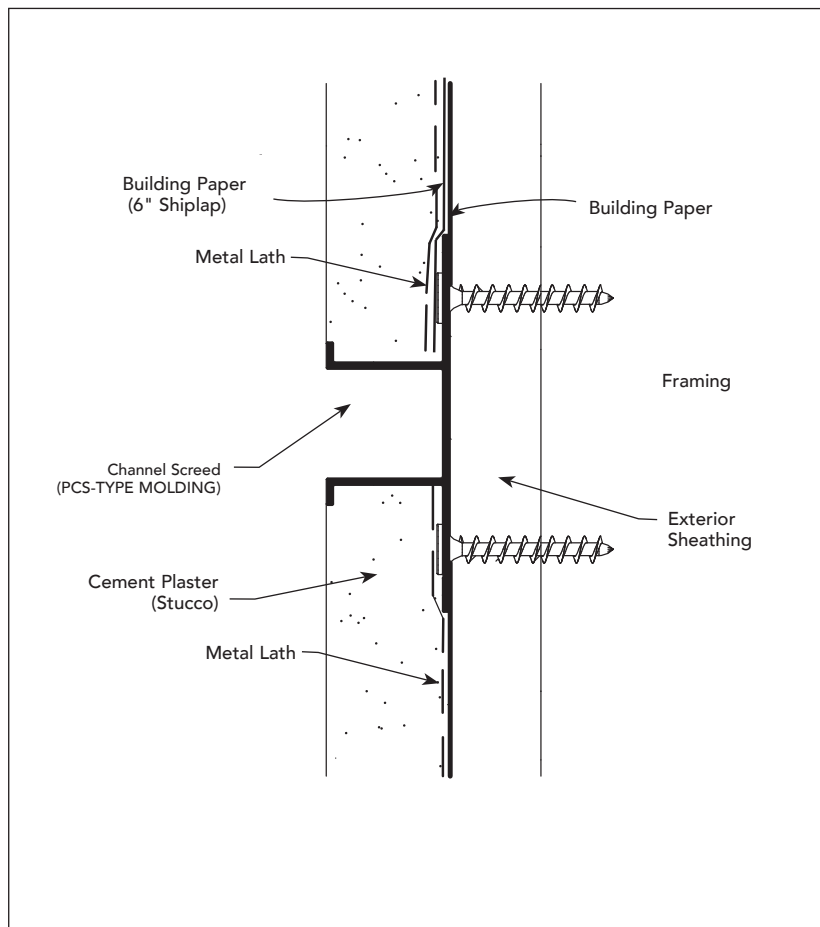



## PJ.4 INSTALLATION

### INSTALLATION 2-PIECE PLASTER EXPANSION JOINT

#### INSTALLATION - 2-PIECE PLASTER EXPANSION JOINT

1. Place building paper behind all moldings and shiplap a minimum of 6".
2. Prior to attachment, place sealant in the movement groove along the back of the molding. **NOTE:** If installation is horizontal, place movement flange on top and lap additional building paper over top flange.
3. Leave alignment clips in place while fastening moldings to framing or studs.
4. Secure moldings on 16" centers using fasteners as appropriate to substrate.
5. Place building paper and wire lath over upper movement installation flange on horizontal installation, and shiplap a minimum of 6". (See Horizontal Installation)
6. Install wire lath over bottom installation flange of moldings.
7. Use vinyl or cloth tape specifically manufactured for masking anodized aluminum trim prior to plastering. For painted surfaces, use plastic tape. **NOTE:** Qualifies for use as an expansion joint for stucco and plaster applications when installed in accordance with ASTM C1063.

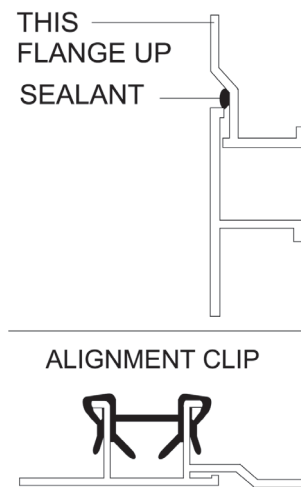

#### SEALANT + CONNECTOR CLIPS

1. The use of sealant at all butt joints and Fry Reglet Connector Clips is recommended.
2. Use Fry Reglet Connector Clips to align molding during installation.
3. Apply sealant as indicated.

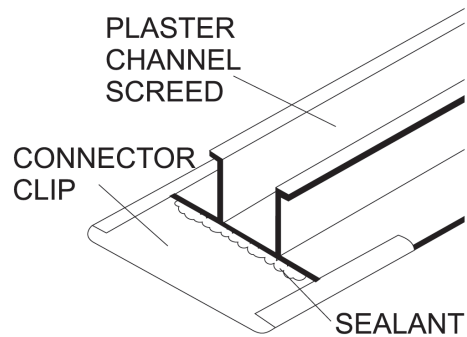

**PJ.5**

**FACTORY FABRICATED INTERSECTIONS**

**FACTORY  
FABRICATED  
INTERSECTIONS**

Factory fabricated intersections and corner pieces of the same or different moldings are used to connect horizontal and vertical joints, or transitioning from plane to plane. The intersections are welded and sealed. Standard leg lengths are 6" from the center point of the reveal. Custom leg lengths are available.

**"T" INTERSECTION**

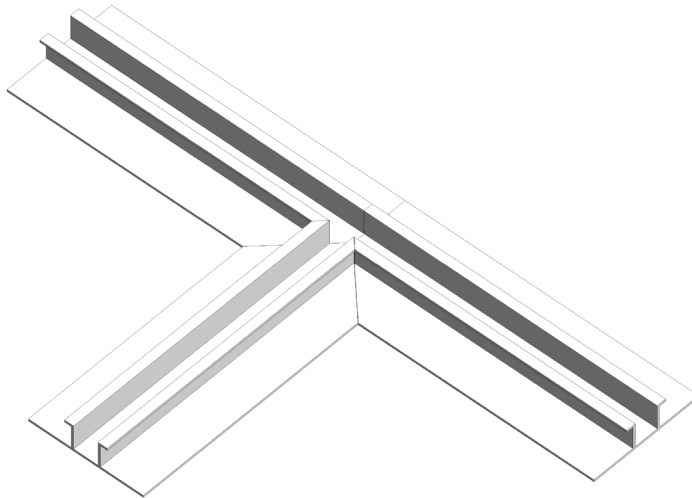

End Caps are not available for all products; please consult a customer service representative.

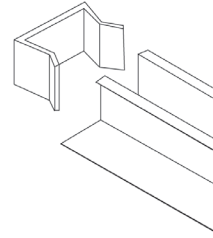

**"+" INTERSECTION**

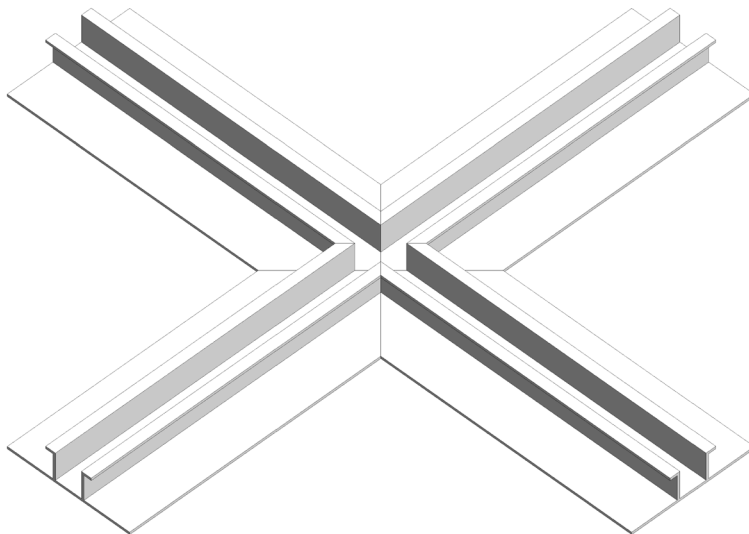

**PJ.6** FACTORY FABRICATED INTERSECTIONS

**FACTORY FABRICATED INTERSECTIONS**

**FACTORY FABRICATED INTERSECTIONS**

Presented as examples of ways Factory Fabricated Intersections can be used to speed installation and reduce costs.

**PREFABRICATED AND PRE-ASSEMBLED JOINTS**

Factory fabricated intersections are available from Fry Reglet to speed installation and reduce labor cost. Intersections are available in the configurations shown below as well as custom configurations and may be made up of the same or different shapes. The joints are welded.

**NOTE:** Water resistant tape is factory applied to the backs of all PCS and DCS factory fabricated intersections.

Intersections are furnished with 6" legs to join with straight sections of moldings.

Custom leg lengths are available.

**PCS CHANNEL REVEAL "L" INTERSECTION**

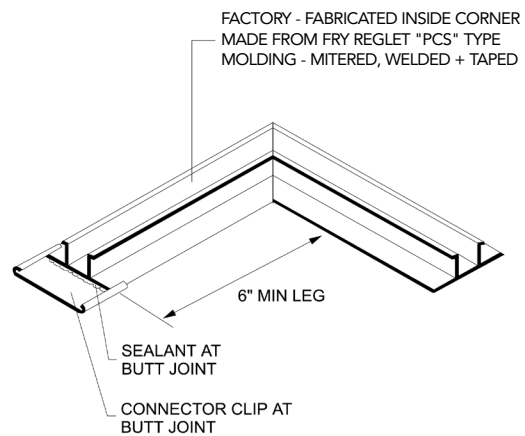

**END CAP**

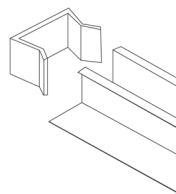

**DRMB WITH END CAP**

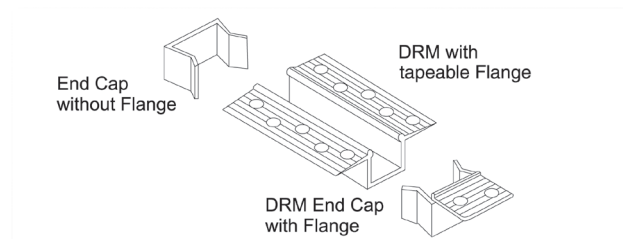
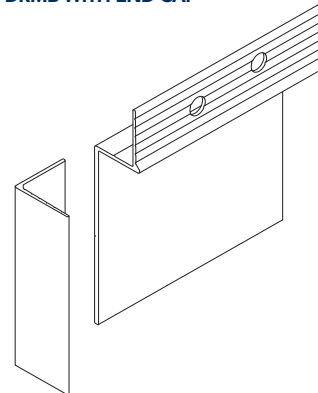

End Caps are not available for all products; please consult a customer service representative.

**PJ.7**

**FACTORY FABRICATED INTERSECTIONS**

**FACTORY  
FABRICATED  
INTERSECTIONS**

**FACTORY FABRICATED INTERSECTIONS**

Presented as examples of ways Factory Fabricated Intersections can be used to speed installation and reduce costs.

**PCS CHANNEL REVEAL INSIDE CORNER**

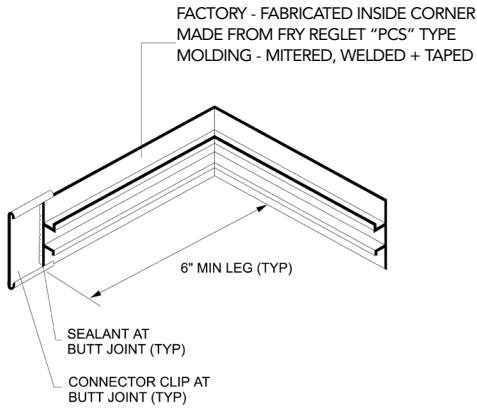

**PCS CHANNEL REVEAL OUTSIDE CORNER**

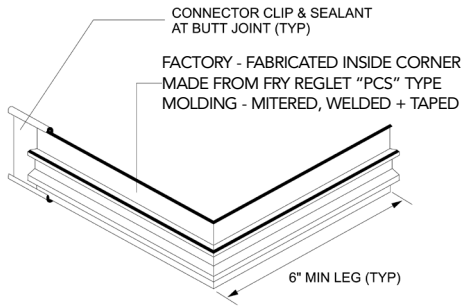

**PCS CHANNEL REVEAL "+" INTERSECTION**

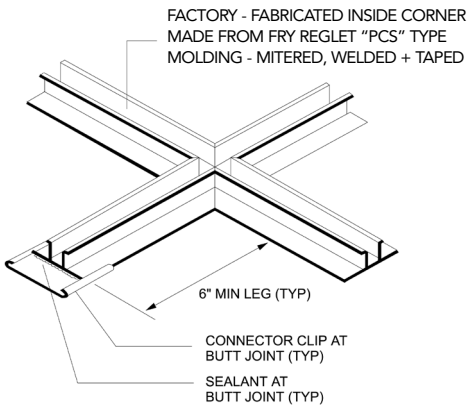

**PCS CHANNEL REVEAL "T" INTERSECTION**

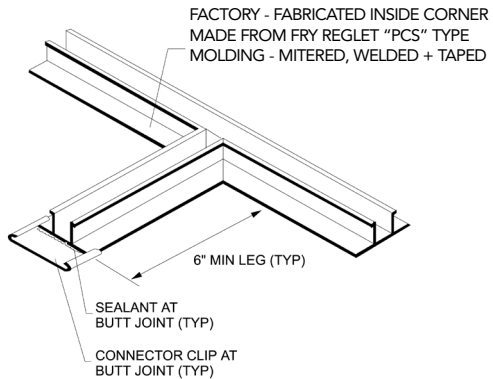

**PJ.8** **FACTORY FABRICATED INTERSECTIONS**

**FACTORY FABRICATED INTERSECTIONS**

**FACTORY FABRICATED INTERSECTIONS**

Presented as examples of ways Factory Fabricated Intersections can be used to speed installation and reduce costs.

**DRM/DRMZ INTERSECTION AT DOORJAMB**

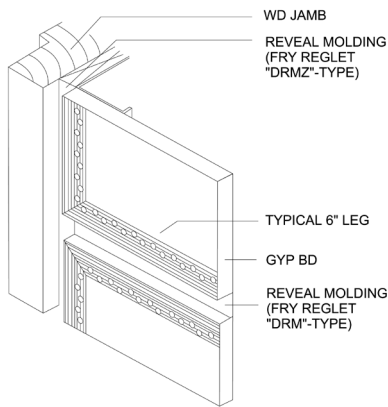

**PCS/PCS 2-PC INTERSECTION**

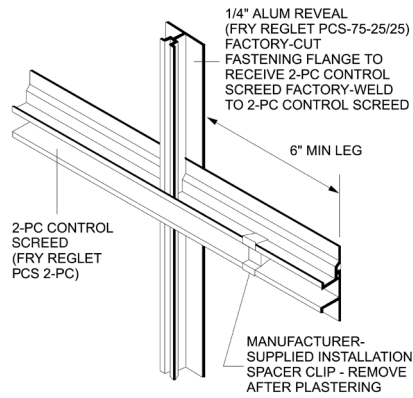

**FPM/PCS WINDOW SILL REVEAL**

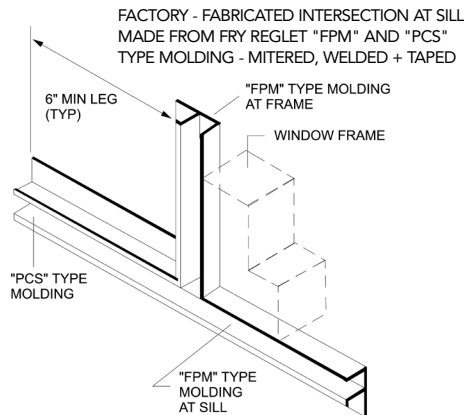

**XCM/PCS CORNER/INTERSECTION**

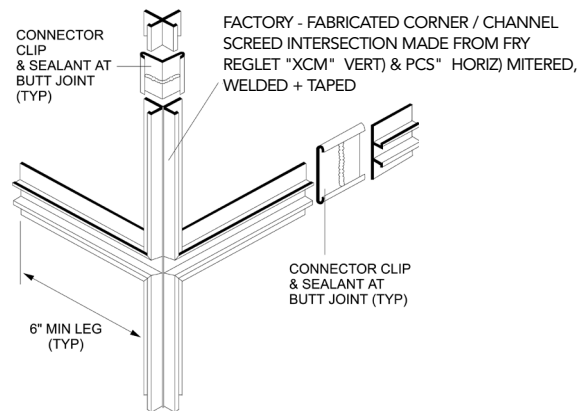

**PJ.9**

**FACTORY FABRICATED INTERSECTIONS**

**FACTORY  
FABRICATED  
INTERSECTIONS**

**FACTORY FABRICATED INTERSECTIONS**

Fry Reglet's expertise at curving moldings combined with factory fabrication of intersections at virtually any angle, permits the complete assembly of decorative elements ready for installation. Two examples are shown below. The first uses curved and straight sections of the same drywall part and the second combines three plaster parts for an intriguing effect. Designers may let their imaginations soar. All that is required is a sketch together with the parts to be used. Fry Reglet will design the decorative element, quote a complete price and furnish a complete assembly, ready to install.

**EXAMPLE 1**

**A SINGLE MOLDING – FACTORY FABRICATED**

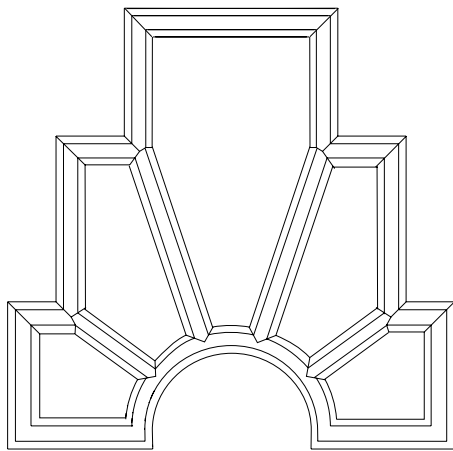

**PART USED: DRM-50-50 DRYWALL REVEAL MOLDING**



**DESCRIPTION**

A straight and curved assembly of reveal moldings serves as the base of this intricate fabrication combining corners and intersections at various angles with straight and curved sections of moldings.

**EXAMPLE 2**

**VARIOUS DISSIMILAR MOLDINGS – FACTORY FABRICATED**

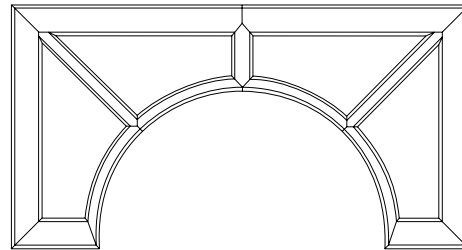

**PARTS USED: PCS-75-75 PLASTER CHANNEL SCREED**



**PCS-75-150 PLASTER CHANNEL SCREED**



**PCS-75-200 PLASTER CHANNEL SCREED**



**DESCRIPTION**

Fry Reglet Plaster Channel Screeds with three reveal widths (3/4", 1 1/2" and 2") are combined to produce this intricate pattern. The widest reveal frames the entire assembly while 1 1/2" width is curved into an attractive design element. The center pattern is assembled from the narrowest moldings.

**PJ.10****CURVED MOLDINGS****CURVED  
MOLDINGS**

With over 20 years experience curving aluminum moldings, Fry Reglet is the leader in this technology. Fry Reglet's curving process is precise and our aluminum moldings hold their shape from the factory to the job site. Whether conforming to conditions such as archways, columns and curved ceilings; or when using Fry Reglet moldings to create a pattern within the wall, Fry Reglet's curving capability can add surprisingly dramatic effects to any project.

**CURVING FRY REGLET MOLDINGS**

Fry Reglet is able to curve virtually any shape in our assortment of drywall and plaster moldings. The only limitation to this process is the size of the curve, measured in terms of the "radius". Radius is the geometric term given to the distance from the center of a circle to its outside edge. The shape of the molding, and the direction of the curve, determine the minimum curve that can be achieved. Contact your local distributor or Fry Reglet's Customer Service Department for price quotations, radius minimums for specific parts and radius order forms.

Fry Reglet's curving process yields 9 usable feet of material from each 10 foot part. Provision for this 10% spoilage should be made when ordering.

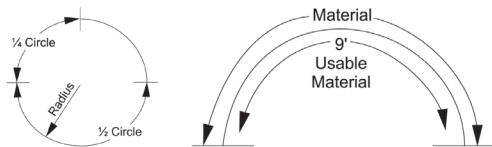
**CURVED TERMINOLOGY****Measuring Radius**

In measuring curves, careful attention should be given to the point on the molding to which the radius is measured. Radius detail sheet indicates Point of Measurement.

**ORDERING CURVED MOLDINGS**

To assist in ordering curved moldings, Fry Reglet requests specific detailed information.

By following the simple steps below, you are assured of obtaining the exact radius desired.

**Indicate Curve Desired**

Contact Fry Reglet Customer Service to obtain radius order sheets.

**Indicate Radius**

Indicate the radius desired from measuring points on radius detail. In most cases the radius measurement should be field checked.

**Indicate Molding + Finish Desired**

Indicate number of molding and finish desired (i.e. DRM 50-150 clear anodized).

**Indicate Quantity**

Indicate total footage desired (add 10% for spoilage).

For additional specification and ordering information contact a customer service representative.

## PK.1

## DRYWALL / PLASTER MOLDING FINISHES

### FINISHES

#### POWDER PAINT

Fry Reglet Powder paint, applied over chemical conversion coating and primer, provides durability and beauty for most interior and exterior applications. This finish is provided as the standard Fry Reglet paint finish.

This factory applied, baked-on finish is available at standard lead times in the colors shown and in custom colors to match swatches provided

#### SPECIFICATION

##### **Powder Paint Shall Be As Follows:**

All surfaces to receive a polyester powder coat will be pretreated in strict accordance with the powder coating manufacturer's specification.

Finish total dry film thickness should meet or exceed the dry film thickness of 30 microns/ 1.2 mils as specified in AAMA 2605 SEC 4.3. Color uniformity will meet or exceed the requirements of AAMA 2605 SEC 7.1

#### KYNAR® PREMIUM FINISH

The industry standard for over 25 years, Fry Reglet Kynar® coatings provide superior resistance to chalking and ultraviolet deterioration. Kynar® finishes are highly resistant to chemicals, salt spray and industrial pollutants. This premium finish is recommended for moldings to be used on exteriors in harsh environments or in coastal areas where salt air is common. Available in all standard Kynar colors and custom colors to match swatches provided.

Kynar® is a registered trademark of ALTOFINA.

#### SPECIFICATION

##### **Kynar® Finish Shall Be As Follows:**

Finish shall meet or exceed AAMA 2605 Specification "Voluntary Specification for High Performance Organic Coatings on Architectural Extrusion Panels." (Nominal dry film thickness shall be .30 mil for primer and 1.0 mil for finish coats).

Finish shall be 70% min. resin content (full strength) polyvinylidene fluoride coating, applied over chemical conversion coating and primer. Coatings shall receive a bake cycle of 17 minutes at 450°F. Kynar® is available by special order only. Contact Fry Reglet for color information.



**PK.3 DRYWALL / PLASTER MOLDING FINISHES****FINISHES****ANODIZED FINISHES**

Anodizing is an electrochemical process in which the aluminum is immersed in an acid solution through which electric current is passed. Although a natural oxidation process commences when bare, unfinished aluminum is exposed to air, producing the oxide film artificially creates a film that is thicker, harder and more durable.

Other anodic coatings are available on special order to satisfy architectural requirements.

Colors available are:

- Medium Bronze
- Light Bronze
- Dark Bronze
- Black

These integral colors are in conformance with the Aluminum Association designation 3AA-M112C22A32.

Also available on special order are other colors using various two-step processes in conformance with the Aluminum Association designation 3AA-12C22A34 for impregnated color. These specifications for color anodizing are for Class II architectural finishes with coating thicknesses up to 0.7 mils.

general note concerning anodized finishes:  
Due to the nature of the anodizing process, shade variations can be expected from one element to another. This inherent characteristic of the finish need be no problem if properly anticipated in the design.

**SPECIFICATION****Clear Anodized Finish Shall Be As Follows:**

STANDARD: Architectural 200R1 medium etch (AA-M32C10A21).

SPECIAL ORDER: Class II Architectural 204R1 medium etch .40 mils min. (AA-M12C22A31)

Thickness of anodic coating shall be tested in accordance with ASTM B-244-68 and sealed to pass the modified dye stain test (ASTM B136-77).

**CHEMICAL CONVERSION COAT FINISHES**

Chemical conversion coating is a multi-step cleaning and metal preparation process. It cleans the aluminum, and acts as a protective coating until primer and paint can be applied. When field painting is planned, chemical conversion coating should be specified.

**SPECIFICATION****Chemical Conversion Coat Finish Shall Be As**

**Follows:** Treatment of aluminum moldings to conform with ASTM D 1730 Type B and MIL-C-5541A.













**PRIME PAINTING**

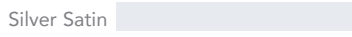



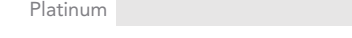

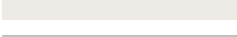



















Fry Reglet Prime Paint is spray applied in the factory and baked-on so that it serves as an ideal base for finish painting in the field.

**SPECIFICATION****Prime Paint Shall Be As Follows:**

Factory sprayed and baked-on to serve as a base for field painting.



















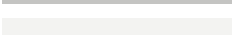

### Powder Coat Colors

Tan		Haze	
Medium Bronze		Adobe	
Dark Bronze		Silver Satin	
Cream		Silver Gray	
White		Platinum	
Black		Gun Metal Gray	
Oyster		Champagne Gold	
Anodized Silver			

Arctic White		Khaki Brown	
Autumn Tan		Light Mist	
Monterey Taupe		Woodstock Brown	
Mountain Sage		Rich Espresso	
Boothbay Blue		Grey Slate	
Cobblestone		Pearl Gray	
Sail Cloth		Deep Ocean	
Countrylane Red		Aged Pewter	
Evening Blue		Night Gray	
Sandstone Beige		Heathered Moss	
Timber Bark		Navajo Beige	
Iron Gray		Slate	
Traditional Red		Emerald	
Woodland Cream			













\*matched to James Hardie colors

---

Autumn Red		Granite Gray	
Sable Brown		Savannah Wicker	
Hearthstone		Marigold	
Suede		Desert Tan	
Taupe		Linen	
Olive		Sterling Gray	
Forest		Snow	
Pacific Blue		Cedar	
Coastal Blue		Maple	
Flagstone		Mahogany	
Pewter		Redwood	

\*matched to Allura colors

---

Aspen Ridge		Stone Blue	
Cascade Slate		Summer Wheat	
Coastal Gray		Tamarack Green	
Mountain Ceder		Timber Trail	
Old Cherry		Vintage Cabernet	
River Rock		Warm Espresso	
Roasted Walnut		White Granite	
Rosewood		Wild Berry	
Smokey Alder		Winchester Brown	
Sand Castle		Caribou Trails	
Midnight Tide		Black Canyon	
White Rapids			

\*matched to Woodtone colors

# FRY REGLET

800-237-9773 | [www.fryreglet.com](http://www.fryreglet.com)