



Quality You Can
Trust...From
North America's
Largest Roofing
Manufacturer!™

Version 1.3

HYDROSTOP® PREMIUMCOAT® LIQUID-APPLIED ROOFING

Application & Specifications Manual



HydroStop® PremiumCoat®

Liquid-Applied Roofing Application & Specifications Manual

Table of Contents

Welcome.....3

Section 1: Guides

Product Guide.....6
Cleaner & Primer Guide.....7
Seam Treatment Guide.....8
Warranty Guide.....9

Section 2: Substrate Preparation

General Substrate Conditions.....11
Moisture Survey.....12
Repair
 Damaged Substrate Treatment: Metal.....13
 Damaged Substrate Treatment: Non-Metal.....14
Cleaning Procedures
 Treatment.....16
General Substrate Preparation
 Metal.....17
 TPO.....20
 PVC & Hypalon®.....21
 EPDM.....22
 Smooth & Granulated Asphaltic.....23
 Structural Concrete.....24
Adhesion Testing
 Test Method #1: Test Patches.....25
 Test Method #2: Field Peel Adhesion (Alternate to Test Patches).....26

Section 3: Quick Spec Directory

| | |
|--|----|
| HydroStop® PremiumCoat® | 28 |
| Metal..... | 29 |
| Smooth & Granulated Asphaltic..... | 30 |
| TPO..... | 31 |
| PVC..... | 32 |
| Hypalon®..... | 33 |
| EPDM..... | 34 |
| Structural Concrete..... | 35 |
| Corrugated Structural Transite Panels..... | 36 |
| Polyisocyanurate (ISO)..... | 37 |
| Gypsum (DensDeck & SecuRock)..... | 38 |
| Warranty Extension/Renewal..... | 39 |
| HydroStop® PremiumCoat® + Kymax | |
| Metal..... | 40 |
| Non-Metal..... | 41 |

Section 4: Care & Preventative Maintenance

| | |
|--|----|
| Overview..... | 43 |
| General Care & Preventative Maintenance Recommendations..... | 43 |
| Semi-Annual Inspections & Maintenance..... | 45 |
| Inspection Checklist..... | 47 |
| Roof Specific Leak Investigation..... | 48 |
| Emergency Repairs..... | 48 |
| Roof Alterations..... | 49 |

Section 5: Architectural Detail Drawings

| | |
|--|----|
| HydroStop® PremiumCoat® | 51 |
| HS-101 Typical Metal Roof Joint Detail..... | 52 |
| HS-102 Section at Vertical Panel Seam..... | 53 |
| HS-104 Deck Joint Stripping Detail..... | 54 |
| HS-201 Standard Drip Edge Detail..... | 55 |
| HS-202 Gutter with Standard Drip Edge Detail..... | 56 |
| HS-203 Concrete Roof Deck Edge Detail..... | 57 |
| HS-300 Alternate Wall Flashing Detail..... | 58 |
| HS-301 Wall Flashing Detail..... | 59 |
| HS-302 Drip Edge Parapet Wall Detail..... | 60 |
| HS-303 Typical Roof Cant At Corner..... | 61 |
| HS-304 Typical Equipment Curb Flashing Detail..... | 62 |
| HS-305 Scupper Detail..... | 63 |
| HS-401 Curb to Curb Expansion Joint Flashing Detail..... | 64 |
| HS-502 Vent-Pipe Flashing Detail..... | 65 |
| HS-503 Vent-Stack Flashing Detail..... | 66 |
| HS-504 Standard Roof Drain Detail..... | 67 |
| HS-505 Exhaust Fan (for Cooking) Flashing Detail..... | 68 |

Thank you for consulting Version 1.3 of the *HydroStop® PremiumCoat® Liquid-Applied Roofing Application & Specifications Manual*. This Manual contains the latest information relating to the application of GAF's HydroStop® PremiumCoat® liquid-applied roofing systems, and is based on our years of experience in the commercial roofing field. It has been prepared as a general guide to assist architects, engineers, roofing contractors, and owners in the use of our liquid-applied roofing systems. You can find further information at www.gaf.com, or contact GAF Technical Services at 1-800-ROOF-411 (1-800-766-3411).

ABOUT GAF

As North America's largest roofing manufacturer, GAF proudly offers a comprehensive portfolio of award-winning, innovative roofing products for both residential and commercial properties. Supported by an extensive national network of factory-certified contractors, GAF has built its reputation—and its success—on its steadfast commitment to Advanced Quality, Industry Expertise, and Solutions Made Simple.

GAF offers all major low-slope roofing technologies, including repair and maintenance products and roof restoration systems, as well as new roofing systems (BUR, modified bitumen, TPO, PVC, and liquid-applied systems). GAF has developed low slope roofing systems with excellent durability and high reflectivity to meet the most rigorous industry standards while helping commercial property owners and designers reduce energy consumption.

For more information about GAF, visit us at www.gaf.com.

SERVICES

- Every GAF roofing product benefits from the substantial resources available only from a multibillion-dollar corporation dedicated to roofing. Our 31 plants mean manufacturing expertise. Our extensive R&D organization means a constant focus on product and process improvement. GAF is a team of over 3,000 people dedicated to your roofing satisfaction.
- GAF has a network of sales representatives and distributors to supply and service its quality roofing systems throughout North America.
- Our Technical Helpline is a technical assistance service that allows you to contact us directly to speak with a technical representative about specifications, applications, code approvals, and product information. The Helpline number is 1-800-ROOF-411 (1-800-766-3411).
- Architectural Information Services (AIS) is a specification service that allows you to specify your exact roofing needs and we will send you a general specification that outlines your job summary, application method, product description, and detail drawings based on the information you provided. The phone number for AIS is 1-800-522-9224.
- Our Tapered Design Group (TDG) is one of the many services available to our customers to help reduce their hassles. We provide tapered insulation take-offs for architects, contractors, and distributors nationwide. Just send your roof plans and specifications to tdg@gaf.com. The phone number for TDG is 1-800-766-3411.
- Visit GAF on the web at www.gaf.com for extensive product information, specifications, and technical literature.

DISCLAIMER

- GAF manufactures and sells roofing materials and does NOT practice architecture or engineering. GAF is NOT responsible for the performance of its products when damage to its products is caused by such things as improper building design, construction flaws, or defects in workmanship.
- The design responsibility remains with the architect, engineer, roofing contractor, or owner, and construction details illustrated and described herein are furnished solely for guidance purposes. These guidelines should not be construed as being all-inclusive, nor should they be considered as a substitute for good application practices.
- Under no circumstances does GAF have any liability for costs or expenses arising out of or associated with the pre-existing presence of asbestos-containing materials or any other allegedly hazardous substances or materials on the roof to which the new GAF roofing materials are being applied.
- Information contained in this Manual is presented in good faith and, to the best of GAF's knowledge, does not infringe upon any patents, foreign or domestic.
- As a part of its continuing efforts to improve the performance of its products, GAF periodically makes changes to its products and application specifications. GAF reserves the right to change or modify, at its discretion, any of the information, requirements, specifications, or policies contained herein. This Manual supersedes all catalogs and previous Manuals.

GENERAL DESIGN CONSIDERATIONS

HOW TO DETERMINE IF A ROOF IS A GOOD CANDIDATE FOR COATING

When installed on a new roof, a roof coating should:

- Be a component part of the larger warranted roofing system. This will ensure compatibility with the system and enhance overall performance of the system.
- Be installed after the roof has weathered as necessary. Weathering periods may vary depending upon the type of system to which the coating will be applied. Use of a primer may also be required for certain substrates to ensure adequate adhesion.

When installed on an existing roof, a roof coating should:

- Be compatible with the existing roof.
- Extend the remaining service life of the existing roof. Although a coating cannot add life back to a roof already beyond its service life, it can prevent a roof from aging as quickly as it would without the coating.
- Only be applied to a roof that drains properly. Some coatings may be adversely affected by the presence of ponding water. Therefore, areas of the existing roof that pond water should be repaired prior to coating.
- Only be applied to non-leaking roofs. While coatings may help seal some pinhole leaks not visible to the naked eye, they will not generally find and repair existing leaks. Accordingly, existing roof leaks will need to be identified and repaired prior to coating. (Allow repairs to fully dry prior to coating.)

NOTE: When coating over an existing roof coating or an existing coal tar pitch roof, contact GAF Technical Services at 1-800-ROOF-411 (1-800-766-3411).

Section 1

Guides

Product Guide

| Type | Product | Description | Base/Cure | VOC (g/L) | % Solids by Volume |
|----------------------------------|---|--|---------------|-----------|--------------------|
| Primers & Cleaner | Acrylex 400 Primer | Water-Based Acrylic Rust-Inhibiting Primer For Metal | Water-Based | <50 | 36 |
| | Adhere-It® II Primer | Water-Based Rinsable Primer For EPDM | Water-Based | n/a | n/a |
| | CleanAct Rinsable Primer | Water-Based Rinsable Primer For EPDM | Water-Based | n/a | n/a |
| | Epoxy Primer (formerly Uniseal Primer) | Water-Based Epoxy Primer For Concrete and Porous Substrates | Water-Based | <120 | 10 |
| | Lock-Down Primer | Moisture-Cure Urethane Primer For Corrosion Protection On Metal Surfaces | Moisture-Cure | <420 | 55 |
| | StableRust Primer | Water-Based Acrylic Rust-Inhibiting Primer | Water-Based | <200 | 56 |
| | SureBond Primer | Water-Based Acrylic Primer For Chalky Surfaces | Water-Based | <200 | 23 |
| | TPO Red Primer | Solvent-Based Primer For TPO Roofs | Solvent-Based | <50 | 1 |
| | UniBase Primer | Water-Based Acrylic Penetrating Primer And Asphalt Bleed Blocker | Water-Based | <50 | 40 |
| | XR-2000 Primer | Water-Based Acrylic Primer For Kynar Coated Metal | Water-Based | < 170 | 40 |
| Roof Coatings | United Cleaning Concentrate (UCC) | Water-Based Roof, Wall and Deck Surface Cleaner | Water-Based | n/a | n/a |
| | HydroStop® BarrierGuard® Waterproofing | Primer For Concrete and Waterproofing | Water-Based | <50 | 39 |
| | HydroStop® PremiumCoat® Finish Coat | Water-Based Acrylic Top Coat | Water-Based | <50 | 52 |
| | HydroStop® PremiumCoat® Foundation Coat | Water-Based Acrylic Base Coat | Water-Based | <50 | 52 |
| | FlexSeal™ Caulk Grade Sealant | Elastomeric Sealant | Solvent-Based | <300 | n/a |
| Flashing, Sealants & Accessories | FlexSeal™ Sealant | Self-Leveling Elastomeric Sealant | Solvent-Based | <300 | 66 |
| | HydroStop® PremiumCoat® Butter Grade Flashing | Water-Based Acrylic Flashing | Water-Based | <50 | 58 |
| | HydroStop® PremiumCoat® Fabric | Stitch-Bonded Polyester Reinforcement | n/a | n/a | n/a |
| | United Coatings™ UniCap Fastener Cover | Self-Adhering Butyl Aluminum Caps For Fasteners | n/a | n/a | n/a |
| | HydroStop® Hydrofiber Bulking Agent | Glass Fiber Bulking Agent | n/a | n/a | n/a |
| | United Coatings™ UniTape Seam Tape | Self-Adhering Butyl Non-Woven Polyethylene Seam Tape | n/a | n/a | n/a |
| | | | | | |

Cleaner & Primer Guide

| Substrate | | Cleaner* | Primer | Application Rates |
|--|--------------------------------|--------------|---|---|
| Metal | Rusty Metal | YES | Acrylex 400 | 0.33-0.67 gal /100 sf (1.4-2.7 L / 10 sq m) |
| | | | or StableRust | 0.33-0.50 gal / 100 sf (1.4-2 L / 10 sq m) |
| | Severe Rusty Metal | YES | Lock-Down Primer | 0.25 gal /100 sf (1 L / 10 sq m) |
| | Kynar Coated Metal | YES | XR-2000 | 0.75 gal /100 sf (3.1 L / 10 sq m) |
| | Residual Asphalt | YES | UniBase | 0.50-1.0 gal /100sf (2-4 L / 10 sq m) |
| Asphaltic (BUR, SBS, APP) | Smooth Asphaltic | YES | UniBase | 0.50-1.0 gal /100sf (2-4 L / 10 sq m) |
| | Granulated Asphaltic | YES | UniBase | 0.50-1.0 gal /100sf (2-4 L / 10 sq m) |
| Single-Ply | TPO (new or aged) | YES | TPO Red Primer | 0.50 gal/100 sf (2 L / 10 sq m) |
| | PVC (aged) | YES | No Primer | n/a |
| | Hypalon (aged) | YES | No Primer | n/a |
| | EPDM | NO | Adhere-It II (or CleanAct) | 0.2 gal/100sf (0.8 L / sq m) |
| Other | Structural Concrete | YES | Epoxy Primer | 0.33 gal/sq (1.4 L/10 m ²) |
| | | | or BarrierGuard | 0.5-1.0 gal/sq; (1.9 L-3.8 L/10 m ²) |
| | Gypsum (Densdeck® & Securock®) | NO | No Primer | n/a |
| | Polyisocyanurate (ISO) | NO | No Primer | n/a |
| | Existing Acrylic Coating | YES | No Primer | n/a |
| Corrugated Structural Transite Panels | YES | Epoxy Primer | 0.33 gal/sq (1.4 L/10 m ²) | |

*United Cleaning Concentrate required

NOTE: Existing silicone coating is not an acceptable substrate for HydroStop® PremiumCoat®.

Seam Treatment Guide

| Substrate | | Product Options (Choose One) |
|------------|--|--|
| Metal | Horizontal Seams | Butter Grade Flashing w/HydroStop® Fabric |
| | | FoundationCoat® w/HydroStop® Fabric |
| | | Liquid Fabric** |
| | | Roof Mate Seam Tape or UniTape |
| Metal | Vertical Seams [Overlap and Trapezoidal seams MUST be treated; other types can forgo treatment if the seal/tape is in tact or if the seam is double locked.] | Butter Grade Flashing |
| | | FoundationCoat® w/HydroStop® Fabric |
| | | Liquid Fabric |
| | | Roof Mate Seam Tape or UniTape |
| Single-Ply | TPO [Loose seams require 3-coursing.] | No Treatment |
| | PVC or Hypalon® [Loose seams require 3-coursing.] | No Treatment |
| | EPDM [Loose seams require 3-coursing.] | No Treatment |
| Asphaltic | Smooth Asphaltic [Loose seams require 3-coursing.] | No Treatment |
| | Granulated Asphaltic [Loose seams require 3-coursing.] | No Treatment |
| Other | ISO or Gypsum Roof Board (Densdeck** or Securock®) *Primed is preferred. | Butter Grade Flashing w/HydroStop® Fabric |
| | | FoundationCoat® w/HydroStop® Fabric |
| | | Roof Mate Seam Tape or UniTape |
| | Structural Concrete [Structural joints to be treated with backer rod and compatible sealant, then coated over with outlined products listed here.] | No Treatment |
| | Corrugated Structural Transite Panels | No Treatment |

**Fabric is REQUIRED for Emerald & Diamond Guarantees; variances may be considered on a case-by-case basis.

HydroStop® PremiumCoat® Liquid-Applied Roofing (LAR) – Version 1.3

Warranty Guide

| | Emerald Pledge™ ¹ | | | Diamond Pledge™ ¹ | | |
|---|---|-------|--------------------|---|-------|--------------------|
| | 10 yr | 15 yr | 20 yr ² | 10 yr | 15 yr | 20 yr ² |
| HYDROSTOP: Who can offer Warranty? | | | | | | |
| Authorized Contractors | No | | | No | | |
| Master & Master Select Contractors | Yes | No | No | No | | |
| Premium Contractors | Yes | | | Yes | | |
| Requirements | | | | | | |
| Moisture Survey for non-metal roofs | Yes | | | Yes | | |
| Pre-Inspection/Approval | Yes, for jobs over 20,000 sq. ft. (1,858 sq m) | | | Yes, for jobs over 20,000 sq. ft. (1,858 sq m) | | |
| Interim Inspection | Yes, for jobs over 10,000 sq. ft. (929 sq m) | | | Yes | | |
| Final Inspection | Yes | | | Yes | | |
| Maintenance Program | Yes | | | Yes | | |
| Transferable | No | | | Yes | | |
| Warranty Registration | Yes | | | Yes | | |
| Coverage | | | | | | |
| Manufacturing Defects | Yes | | | Yes | | |
| Ordinary Wear & Tear | Yes | | | Yes | | |
| Workmanship | No | | | Yes | | |
| Remedy | | | | | | |
| Materials | Yes | | | Yes | | |
| Labor | Yes | | | Yes | | |

NOTES:

1. Liquid-Applied Emerald Pledge™ and Diamond Pledge™ must be applied per specifications.
2. Pre-Approval required for all 20 year Warranties by Director or above (Sales or Field Services).

Section 2

Substrate Preparation

GENERAL SUBSTRATE CONDITIONS

Preparation of the roof substrate is the responsibility of the installer, who must address and correct all of the conditions listed in this section.

- Examine substrates to receive new roofing. If any questions arise regarding the compatibility of HydroStop® PremiumCoat® liquid-applied roofing products with an existing substrate, Installer shall prepare test patches to check adhesion.
- Do not proceed with the installation of the HydroStop® PremiumCoat® liquid-applied roofing system until compatibility and adhesion of HydroStop® PremiumCoat® roofing system has been verified by test patches and other preparatory work has been completed and unsatisfactory conditions have been corrected.
- Roof must have positive drainage. Substrate should not pond water for more than 48 hours after precipitation stops.
 - GAF defines “ponding” as water that does not drain or dissipate from the roof surface within 48 hours after precipitation ends. Ponding can also result from other water sources, including improperly piped air conditioning condensate and steam condensate lines.
- Protect adjacent surfaces that will not be coated.
- Do not apply liquid-applied roofing products to surfaces unacceptable to GAF, or under inclement environmental conditions.
- Substrates must be clean, completely dry, and free of any debris before application of any liquid-applied products.
- HydroStop® PremiumCoat® liquid-applied roofing products should not be used on heavy-traffic bearing substrates. If foot traffic is expected, a rooftop walkway system approved by GAF must be used.

Always contact GAF’s Technical Services Department (800-766-3411) for questions regarding suitable substrates, materials for test patches, or if you require additional information.

PROPER PREPARATION FOR ROOF TYPES

To ensure proper coating application, the existing roof membrane must be thoroughly cleaned. All dust, chalking film, bitumen exudate, greases or oils, and other loose debris should be removed prior to coating. Be careful when pressure washing to preserve the integrity of the existing roof membrane and to avoid damage to membrane seams (especially adhered seams). Allow the roof to dry completely prior to coating. Any required roof or flashing repairs should be completed and allowed to adequately cure where necessary. Refer to specific sections of this Manual for more information on roof preparation.

Depending on type of existing substrate and the coating to be applied, use of a primer may be required. Surfaces which typically require primer include: metal flashings, gravel stops, and other metal edging; concrete roof decks, masonry walls and other floor surfaces, and other porous surfaces. Refer to specific sections of this Manual for detailed requirements.

While rusted metal roofs can be coated, additional measures may be required. If the roof is affected by “white rust” (i.e., zinc or aluminum), it can be coated after cleaning. However, if the roof is affected by “red rust,” the rust must either be removed or treated with corrosion inhibiting primer. Additionally, all rusted fasteners should also be removed or treated with a corrosion inhibiting primer.

WHAT IS BENEATH THE EXISTING ROOF SURFACE?

In membrane roof systems, there is typically a layer of insulation beneath the membrane. If the roof has ever experienced leaks, it is possible that there are areas of wet insulation in the existing roofing system. All wet roof insulation must be removed and replaced prior to coating. While certain areas of wet insulation may be noticeable simply by walking on them, an infrared moisture scan is recommended to more accurately determine areas of wet insulation.

Metal roofs are typically installed over a solid roof deck or over purlins and insulation. Examining the underside of the roof deck can reveal areas of wet insulation, deteriorated deck or other damage that needs to be repaired prior to coating.

MOISTURE SURVEY

It is the responsibility of the roofing contractor to determine the suitability of any substrate to receive a liquid-applied coating system. Roof moisture surveys are a common tool used to assist with this determination. When the deck/substrate has more potential to “hold” water, a moisture survey may be required by GAF.

Alternately, for decks/substrates such as steel, the use of roof cuts to verify the suitability of the substrate can be effective.

Where a moisture survey is performed:

- GAF requires a moisture survey be conducted by the roofing contractor prior to warranty issuance for Emerald Pledge™ and Diamond Pledge™ Guaranteed Systems installed over existing roofs.
- If the moisture survey shows areas of the roof that are wet, remove and replace all wet areas with new materials. Make typical repairs with original roof technology and follow the appropriate surface preparation steps.
- Moisture surveys include: IR scans, nuclear scans, test/core cuts, and portable devices used to indicate moisture.

Liquid-Applied Roofing Systems Roof Moisture Survey Criteria

| Emerald™ Pledge & Diamond Pledge™ Guaranteed Systems | | | |
|--|-------------------------------|---|--|
| Project Size | Less than 100 Sqs. (929 sq m) | 100 Sqs. (929 sq m) or Greater | |
| Roof Survey Criteria | Roof Surveys Recommended | Roof Surveys Recommended | Roof Surveys Required |
| Deck/Substrate (non-standing seam metal†) | All* | <ul style="list-style-type: none"> • Steel* • Wood* • Cementitious Wood Fiber (Tectum or equivalent)* • Gypsum* | <ul style="list-style-type: none"> • Structural Concrete • Lightweight Insulating Concrete** • Existing Spray Polyurethane Foam • Any existing system with a vapor retarder • Any existing system that is a recover system • Any existing system with significant ponding water (e.g. poor drainage) |
| Liquid-Applied Limited Warranty | | | |
| Project Size | Any Project Size | | |
| Roof Survey Criteria | Roof Surveys Recommended* | | |

*Without significant ponding water. Minimum of (3) three roof cuts for the first 100 squares (929 sq m) and (1) one test cut per additional 100 squares (929 sq m) are required to verify existing roof conditions are acceptable and/or to determine where moisture is present.

**For lightweight insulating concrete decks, please contact GAF Technical Services at 800-766-3411.

†Roof moisture surveys are not required/recommended for any system installed over an existing standing seam metal roof or when the liquid-applied roofing system is applied directly to an approved deck (not as a recover system).

REPAIR

Inspect and make all necessary repairs to damaged substrates. Refer to the Damaged Substrate Treatment sections below for substrate-specific information.

| Damaged Substrate Treatment: Metal | |
|------------------------------------|---|
| Areas of Concern | Treatment |
| Rust Areas | <ul style="list-style-type: none"> Severely damaged or rusted seams and/or fasteners must be replaced. Roof panels that are corroded to the point where they have holes must be replaced. Light rust areas must be treated to prevent further deterioration on metal panels. Roof surface shall have no more than 20% rust or must have panels replaced. |
| Fasteners | <ul style="list-style-type: none"> All fasteners must be retightened, secured, or replaced as necessary. All stripped fasteners must be replaced with new larger fasteners. All deteriorated and missing fasteners must be replaced. All fasteners must be fully encapsulated with HydroStop® PremiumCoat® Butter Grade Flashing or fastened with UniCap Fastener Covers (refer to the Product Data Sheet for specific application requirements). |
| Dented / Damaged Panels | <ul style="list-style-type: none"> Dents must be mechanically removed to the maximum extent possible. Cover broken rib area with a sheet metal cap and seal with HydroStop® PremiumCoat® Butter Grade Flashing prior to attaching the cap with fasteners. Severely damaged roof panels must be replaced. |
| Excessive Gaps | <ul style="list-style-type: none"> Seal cracks, joints, penetrations, and curbs with appropriate sealant materials as recommended. |
| Seams | <ul style="list-style-type: none"> Repair all seams as needed. Refer to the Seam Treatment section in this Manual for specific seam treatment guidance. |
| Open Ridge Vents | <ul style="list-style-type: none"> Replace or install sheet metal caps over the open ridge vents when they are rusted on the inside and/or located in a harsh environment (e.g., salt water areas). Do not seal weep holes on vents. |

| Damaged Substrate Treatment: Non-Metal | |
|---|---|
| Substrate | Treatment |
| TPO | <ul style="list-style-type: none"> Any areas where TPO has torn, cracked, and/or buckled, or where scrim is exposed must be repaired using similar compatible materials to the current roof. Any wet insulation must be replaced. Allow at least 48 hours drying time after the cleaning process before application of HydroStop® PremiumCoat® liquid-applied products. |
| PVC or Hypalon® | <ul style="list-style-type: none"> Any areas where PVC or Hypalon has torn, cracked, and/or buckled, or where scrim is exposed must be repaired using similar compatible materials to the current roof. Any wet insulation must be replaced. Allow at least 48 hours drying time after the cleaning process before application of HydroStop® PremiumCoat® liquid-applied products. |
| Spray Polyurethane Foam | <ul style="list-style-type: none"> All areas where the urethane foam has degraded must be scarified and re-foamed to bring substrate to a smooth, workable surface. Any areas where foam has become wet must be removed and re-foamed. |
| EPDM | <ul style="list-style-type: none"> Any areas where EPDM has torn, cracked, and/or buckled must be repaired using similar compatible materials to the current roof. Any wet insulation must be replaced. Allow at least 48 hours drying time after the cleaning process before application of HydroStop® PremiumCoat® liquid-applied products. |
| Mineral & Granule Surfaced BUR or Modified Bitumen (SBS & APP) <u>OR</u> Smooth Surfaced BUR or Modified Bitumen (SBS & APP) | <ul style="list-style-type: none"> Any areas where asphaltic membrane has blistered, buckled, become wet and/or otherwise been damaged must be removed and repaired using similar compatible materials to the current roof. New BUR or modified bitumen repair materials must be allowed to weather at least 30 days before applying liquid-applied products to repaired areas. All areas where BUR or modified bitumen surface have significantly cracked (gaps 1/16" [1.6 mm] or greater in width and/or depth) must be repaired using flashing grade coating to create a smooth, workable surface on the substrate. Allow flashing grade coating at least 24 hours drying time before application of HydroStop® PremiumCoat® liquid-applied products. Areas with thicker applications may require additional drying time. Gravel-surfaced BUR or modified bitumen roofing systems are not a suitable substrate to receive a HydroStop® PremiumCoat® liquid-applied coating. |

| Damaged Substrate Treatment: Non-Metal (Cont'd.) | |
|---|--|
| Substrate | Treatment |
| Corrugated Structural Transite Panels | <ul style="list-style-type: none"> • All large or excessive gaps (greater than 1/4" [6 mm]) existing between roof panels must be filled or made flush with closed-cell foam strips or polyurethane foam to pre-fill voids. • All fasteners must be retightened, secured, or replaced as necessary. All stripped fasteners must be replaced with larger fasteners. • All deteriorated or missing fasteners must be replaced. All fasteners must be fully encapsulated with HydroStop® PremiumCoat® Butter Grade Flashing or fastened with UniCap Fastener Covers. • Repair all horizontal seams as needed. Refer to the Seam Treatment section in this Manual for specific seam treatment guidance. • Many of these panels can contain asbestos. Refer to the Environmental Considerations in the Cleaning Procedures section in this Manual for further information. |
| Structural Concrete | <ul style="list-style-type: none"> • All large or excessive gaps (greater than 1/4" [6 mm]) must be repaired using high-quality concrete grout. Grout must fully cure before application of HydroStop® PremiumCoat® liquid-applied coating system. • Correct areas of ponding water. |

CLEANING PROCEDURES

| Treatment | |
|--|---|
| General Surface Prep | <ul style="list-style-type: none"> • Clean and prepare surfaces to receive liquid-applied roofing products. Remove all dirt, dust, loose and flaking particles, grease, oil, laitance, pollution fallout, and other contaminants that may interfere with proper adhesion. • Use a stiff bristle push broom and/or pressure washing for cleaning and surface preparation. • When encountering roof substrates that have living organisms such as algae, mold or fungus, a <u>sterilant such as 3:1 bleach solution</u> must be used to kill and remove these organisms during the roof cleaning. |
| Pressure Washing | <ul style="list-style-type: none"> • Substrate must be pressure-washed with water and/or approved cleaner. Refer to the Cleaner & Primer Guide in this Manual for specific cleaner information for the substrate you are working with. • A minimum working pressure of 2,000 psi is to be used to remove all dirt, dust, chalking and waste products (oil, oil-based roof cements, solvents, grease, animal fats, etc.). • Concrete, EPDM, and metal substrates should use a minimum working pressure of 3,000 psi. • Care should be taken not to damage the roof surface or inject water into the substrate during washing. • Allow at least 48 hours for complete drying after the cleaning process. |
| Important! Environmental Considerations | <ul style="list-style-type: none"> • Corrugated or structural transite panels are likely to contain significant amounts of asbestos, which may be released during pressure-washing. Asbestos dust is an extreme health hazard and known as a carcinogen. It is the Installer's responsibility to check with state and local agencies regarding proper disposal, as well as the proper protection for workers exposed to this material. • Roof wash-off catchment systems should be in place when required. Be sure to follow state and local requirements for roof-wash off catchments during the cleaning process. |

Note: Under no circumstances does GAF have any liability for expenses arising out of or associated with the presence of asbestos-containing materials or any other allegedly hazardous substances or materials on the roof to which the new GAF roofing materials are being applied.

GENERAL SUBSTRATE PREPARATION

| Substrate Preparation: Metal | |
|---------------------------------------|--|
| Areas of Concern | Preparation |
| Crickets | <ul style="list-style-type: none"> • Sheet metal crickets must be installed according to metal deck manufacturer's specifications. • New crickets must be sealed with HydroStop® PremiumCoat® Butter Grade Flashing under the flanges before they are mechanically attached to the curb unit and metal roof panel. • Stitch-screw cricket flanges to the curb unit and metal roof panel while the HydroStop® PremiumCoat® Butter Grade Flashing is still wet using fasteners. |
| Ponding Water Areas | <ul style="list-style-type: none"> • Make every effort to eliminate all ponding water areas prior to coatings application. • Treat ponding water areas which cannot be eliminated with HydroStop® BarrierGuard® bulked with HydroFiber prior to application of other coatings. If ponding water cannot be eliminated, areas should be treated with a 3-course application of HydroStop® BarrierGuard® and fabric. |
| Residual Asphalt | <ul style="list-style-type: none"> • Remove any existing asphaltic roof coating. • Any residual asphalt must be coated with UniBase Primer (see Cleaner & Primer Guide). |
| Pre-Finished Metal Panels | <ul style="list-style-type: none"> • If roof panel surfaces are known or suspected to contain Kynar-500, other fluoropolymers, or silicone, test patches need to be prepared with and without the use of XR-2000 Primer (see Cleaner & Primer Guide). Based on test patch adhesion results, Installer should apply primer on pre-finished metal panels per specifications. |
| Pitch Pans | <ul style="list-style-type: none"> • Pitch pans must be capped with sheet metal so they can be sealed with HydroStop® PremiumCoat® Butter Grade Flashing. Contact GAF's Technical Services Department for more information. |
| Neoprene Pipe Boots | <ul style="list-style-type: none"> • Install neoprene boots prior to performing flashing work for certain types of pipe penetrations. Neoprene boots first must be sealed to the roof using a bead of HydroStop® PremiumCoat® Butter Grade Flashing prior to mechanical attachment with fasteners. |
| Condensate Lines | <ul style="list-style-type: none"> • Condensate lines should be installed from the HVAC units to gutters as part of the overall roofing contract. Type of piping used for condensate lines may vary depending on local building codes. • Condensate lines must be securely fastened to panel ribs. All fastener heads must be encapsulated with HydroStop® PremiumCoat® Butter Grade Flashing. |
| Cinch Straps at Panel End Laps | <ul style="list-style-type: none"> • Re-tighten cinch straps as necessary. • Surround each strap and fastener head with a bead of HydroStop® PremiumCoat® Butter Grade Flashing. • Encapsulate the cinch strap water channel, then seal the entire lap, strap, and fastener heads with a minimum of 12 inches (305 mm) width of HydroStop® PremiumCoat® Butter Grade Flashing. Feather the HydroStop® PremiumCoat® Butter Grade Flashing out. Fabric is not required. |

Substrate Preparation: Metal (Cont'd.)

| Areas of Concern | Preparation |
|-----------------------------|--|
| Ridge Caps | <ul style="list-style-type: none"> • All ridge caps must be flashed with HydroStop® PremiumCoat® Butter Grade Flashing with fabric. • All voids and open areas in the ridge cap must be filled with polyurethane foam prior to application of the coating and fabric. • For metal "Z" closures which are located within 2 inches (51 mm) of the ridge cap edge, remove all exposed sealant and apply a liberal bead of HydroStop® PremiumCoat® Butter Grade Flashing with fabric to all sides of the "Z" closure where they intersect with both the roof panel and ridge cap. |
| Rakes | <ul style="list-style-type: none"> • All fixed rake details for the roof must be secured and sealed with 12 inches (305 mm) minimum width of HydroStop® PremiumCoat® Butter Grade Flashing with fabric. • If fixed rake metal is fastened to the top of roof panel ribs and extends back onto the roof, trim off any excess metal and follow horizontal seam flashing procedures. • All voids and open areas must be filled with polyurethane foam prior to application of the coating and fabric. |
| Parapet Walls | <ul style="list-style-type: none"> • All parapet wall details within the roof system must be secured and sealed with 12 inches (305 mm) minimum width of HydroStop® PremiumCoat® Butter Grade Flashing with fabric. • If parapet wall flashing metal is fastened to the top of roof panel ribs and extends back onto the roof, trim off any excess metal and follow horizontal seam flashing procedures. • All voids and open areas must be filled with polyurethane foam prior to application of HydroStop® PremiumCoat® Butter Grade Flashing with fabric. • Fabric must be cut around all fasteners so it lies flat. United Coatings™ UniCap fastener covers can alternatively be used. |
| Standing Seam Panels | <ul style="list-style-type: none"> • Contact GAF's Technical Services Department (800-766-3411). |
| Curb Flashings | <ul style="list-style-type: none"> • All curb flashings, including cricket details, must be flashed with at least a 12 inch (305 mm) width of HydroStop® PremiumCoat® Butter Grade Flashing with fabric. • Encapsulate all fasteners using HydroStop® PremiumCoat® Butter Grade Flashing with fabric. Do not bridge fasteners. • The fabric must be cut around all fasteners so the fabric lies flat. |
| Penetrations | <ul style="list-style-type: none"> • HydroStop® PremiumCoat® Butter Grade Flashing with fabric should be applied around the base of all penetrations, extending at least 6 inches (152 mm) up the vertical and 6 inches (152 mm) onto the base. • Cut the fabric to accommodate the shape of the penetration. |
| Skylights | <ul style="list-style-type: none"> • Curb skylights must be treated in the same fashion as curb flashings. • After flashing work has been completed and the coating has cured, treat deteriorated fiberglass skylight panels with United Coatings™ Acrysheen Sealer. |

| Substrate Preparation: Metal (Cont'd.) | | |
|--|--------------------------|---|
| | Areas of Concern | Preparation |
| VERTICAL SEAMS | Ribbed Seam | <ul style="list-style-type: none"> All ribbed panel vertical seams must be sealed with HydroStop® PremiumCoat® Butter Grade Flashing. Feather the coating until seams are no longer visible while brushing in the direction parallel to the seam. |
| | Standing Seam | <ul style="list-style-type: none"> All standing vertical seams must be sealed with a 1/2 inch (12 mm) bead of HydroStop® PremiumCoat® Butter Grade Flashing. Feather the coating until seams are no longer visible while brushing in the direction parallel to the seam. |
| | Standing "T" Seam | <ul style="list-style-type: none"> Both vertical seams of the standing "T" must be flashed with a 1/2 inch (12 mm) bead of the HydroStop® PremiumCoat® Butter Grade Flashing and brushed into the seams. |
| | Inverted "J" Seam | <ul style="list-style-type: none"> In snowy climates and/or when roof leaks are suspected, re-crimping the short leg of the seam all the way under the horizontal portion of the inverted "J" seam is required. Brush or trowel-apply HydroStop® PremiumCoat® Butter Grade Flashing over the newly created single lock vertical seam. Portable seamers may be used to perform the re-crimping. |
| | Corrugated Seam | <ul style="list-style-type: none"> All corrugated panel vertical seams must be sealed with HydroStop® PremiumCoat® Butter Grade Flashing. Feather the coating until seams are no longer visible while brushing in the direction parallel to the seam. |
| | Batten Seam | <ul style="list-style-type: none"> Both vertical seams of the batten must be flashed with a 1/2 inch (12 mm) bead of HydroStop® PremiumCoat® Butter Grade Flashing. Feather the coating until seams are no longer visible while brushing in the direction parallel to the seam. |
| HORIZONTAL SEAMS | Horizontal Seam | <ul style="list-style-type: none"> All seams must be reinforced with two layers of HydroStop® PremiumCoat® Butter Grade Flashing with fabric or TOPCOAT® Liquid Fabric. The coating must be feathered at least 1 inch (25 mm) beyond each side of the 6 inch (152 mm) width to allow water to flow over the seam. Fabric must be cut around all fasteners so it lies flat. For ribbed roof panels, the fabric must be applied over panel ribs in continuous lengths. A minimum 2 inches (51 mm) overlap is required for all splices in fabric. Horizontal seams must be secured with fasteners on the high side of every other corrugation, spaced no more than 12 inches (305 mm) on center. The horizontal seam must be made flush by installing two fasteners per flute. |

| Substrate Preparation: TPO | |
|-----------------------------------|--|
| Areas of Concern | Treatment |
| Parapet Walls | <ul style="list-style-type: none"> • Repair all open seams and any loose or failed terminations with in-kind materials prior to application of HydroStop® PremiumCoat® Butter Grade Flashing with fabric. • All parapet wall details within the roof system must be secured and sealed with a 12 inch (305 mm) minimum width of HydroStop® PremiumCoat® Butter Grade Flashing with fabric. • Fabric must be cut around all fasteners so it lies flat. |
| Curb Flashings | <ul style="list-style-type: none"> • All curb flashings, including cricket details, must be flashed with at least a 12 inch (305 mm) width of HydroStop® PremiumCoat® Butter Grade Flashing with fabric. • Encapsulate all fasteners using HydroStop® PremiumCoat® Butter Grade Flashing with fabric. Do not bridge fasteners. • Fabric must be cut around all fasteners so it lies flat. |
| Penetrations | <ul style="list-style-type: none"> • HydroStop® PremiumCoat® Butter Grade Flashing with fabric must be applied around the base of all penetrations, extending at least 6 inches (152 mm) up the vertical and 6 inches (152 mm) onto the base. • Cut the fabric to accommodate the shape of the penetration. |
| Skylights | <ul style="list-style-type: none"> • Curb skylights must be treated in the same fashion as curb flashings. • After flashing work has been completed and the coating has cured, treat deteriorated fiberglass skylight panels with United Coatings™ Acrysheen Sealer. |
| Pitch Pans | <ul style="list-style-type: none"> • Pitch pans must be capped with sheet metal so that they may be sealed with HydroStop® PremiumCoat® Butter Grade Flashing. |
| Condensate Lines | <ul style="list-style-type: none"> • Condensate lines must be installed from HVAC units to gutters as part of the overall drainage system. The type of piping used for condensate lines may vary depending on local building codes. |

| Substrate Preparation: PVC & Hypalon® | |
|--|--|
| Areas of Concern | Treatment |
| Parapet Walls | <ul style="list-style-type: none"> • Repair all open seams and any loose or failed terminations with in-kind materials prior to application of HydroStop® PremiumCoat® Butter Grade Flashing with fabric. • All parapet wall details within the roof system must be secured and sealed with a 12 inch (305 mm) minimum width of HydroStop® PremiumCoat® Butter Grade Flashing with fabric. • Fabric must be cut around all fasteners so it lies flat. |
| Curb Flashings | <ul style="list-style-type: none"> • All curb flashings, including cricket details, must be flashed with at least a 12 inch (305 mm) width of HydroStop® PremiumCoat® Butter Grade Flashing with fabric. • Encapsulate all fasteners using HydroStop® PremiumCoat® Butter Grade Flashing with fabric. Do not bridge fasteners. • Fabric must be cut around all fasteners so it lies flat. |
| Penetrations | <ul style="list-style-type: none"> • HydroStop® PremiumCoat® Butter Grade Flashing with fabric must be applied around the base of all penetrations, extending at least 6 inches (152 mm) up the vertical and 6 inches (152 mm) onto the base. • Cut the fabric to accommodate the shape of the penetration. |
| Skylights | <ul style="list-style-type: none"> • Curb skylights must be treated in the same fashion as curb flashings. • After flashing work has been completed and the coating has cured, treat deteriorated fiberglass skylight panels with United Coatings™ Acrysheen Sealer. |
| Pitch Pans | <ul style="list-style-type: none"> • Pitch pans must be capped with sheet metal so that they may be sealed with HydroStop® PremiumCoat® Butter Grade Flashing. |
| Condensate Lines | <ul style="list-style-type: none"> • Condensate lines must be installed from HVAC units to gutters as part of the overall drainage system. The type of piping used for condensate lines may vary depending on local building codes. |

Substrate Preparation: EPDM

| Areas of Concern | Treatment |
|-------------------------|--|
| Parapet Walls | <ul style="list-style-type: none"> • Repair all open seams and any loose or failed terminations with in-kind materials prior to application of HydroStop® PremiumCoat® Butter Grade Flashing with fabric. • All parapet wall details within the roof system must be secured and sealed with a 12 inch (305 mm) minimum width of HydroStop® PremiumCoat® Butter Grade Flashing with fabric. • Fabric must be cut around all fasteners so it lies flat. |
| Curb Flashings | <ul style="list-style-type: none"> • All curb flashings, including cricket details, must be flashed with at least a 12 inch (305 mm) width of HydroStop® PremiumCoat® Butter Grade Flashing with fabric. • Encapsulate all fasteners using HydroStop® PremiumCoat® Butter Grade Flashing with fabric. Do not bridge fasteners. • Fabric must be cut around all fasteners so it lies flat. |
| Penetrations | <ul style="list-style-type: none"> • HydroStop® PremiumCoat® Butter Grade Flashing with fabric must be applied around the base of all penetrations, extending at least 6 inches (152 mm) up the vertical and 6 inches (152 mm) onto the base. • Cut the fabric to accommodate the shape of the penetration. |
| Skylights | <ul style="list-style-type: none"> • Curb skylights must be treated in the same fashion as curb flashings. • After flashing work has been completed and the coating has cured, treat deteriorated fiberglass skylight panels with United Coatings™ Acrysheen Sealer. |
| Pitch Pans | <ul style="list-style-type: none"> • Pitch pans must be capped with sheet metal so that they may be sealed with HydroStop® PremiumCoat® Butter Grade Flashing. |
| Condensate Lines | <ul style="list-style-type: none"> • Condensate lines must be installed from HVAC units to gutters as part of the overall drainage system. The type of piping used for condensate lines may vary depending on local building codes. |

| Substrate Preparation: Smooth & Granulated Surfaced Asphaltic | |
|--|--|
| Areas of Concern | Treatment |
| Parapet Walls | <ul style="list-style-type: none"> • Repair all open seams and any loose or failed terminations with in-kind materials prior to application of HydroStop® PremiumCoat® Butter Grade Flashing with fabric. • All parapet wall details within the roof system must be secured and sealed with a 12 inch (305 mm) minimum width of HydroStop® PremiumCoat® Butter Grade Flashing with fabric. • Fabric must be cut around all fasteners so it lies flat. |
| Curb Flashings | <ul style="list-style-type: none"> • All curb flashings, including cricket details, must be flashed with at least a 12 inch (305 mm) width of HydroStop® PremiumCoat® Butter Grade Flashing with fabric. • Encapsulate all fasteners using HydroStop® PremiumCoat® Butter Grade Flashing with fabric. Do not bridge fasteners. • Fabric must be cut around all fasteners so it lies flat. |
| Penetrations | <ul style="list-style-type: none"> • HydroStop® PremiumCoat® Butter Grade Flashing with fabric must be applied around the base of all penetrations, extending at least 6 inches (152 mm) up the vertical and 6 inches (152 mm) onto the base. • Cut the fabric to accommodate the shape of the penetration. |
| Skylights | <ul style="list-style-type: none"> • Curb skylights must be treated in the same fashion as curb flashings. • After flashing work has been completed and the coating has cured, treat deteriorated fiberglass skylight panels with United Coatings™ Acrysheen Sealer. |
| Pitch Pans | <ul style="list-style-type: none"> • Pitch pans must be capped with sheet metal so that they may be sealed with HydroStop® PremiumCoat® Butter Grade Flashing. |
| Condensate Lines | <ul style="list-style-type: none"> • Condensate lines must be installed from HVAC units to gutters as part of the overall drainage system. The type of piping used for condensate lines may vary depending on local building codes. |

NOTE: For spudded gravel surfaces, please contact GAF Technical Services (800-766-3411).

| Substrate Preparation: Structural Concrete | |
|--|---|
| Areas of Concern | Treatment |
| Parapet Walls | <ul style="list-style-type: none"> • Repair all cracked, spalled and open concrete holes with an in-kind cementitious patch. Repair any loose or failed seams with similar materials as originally used. This is commonly a polyurethane sealant with a closed cell polyethylene backer rod. • All parapet wall details within the roof system must be secured and sealed with a 12 inch (305 mm) minimum width of HydroStop® PremiumCoat® Butter Grade Flashing with fabric. • Fabric must be cut around all fasteners so it lies flat. |
| Curb Flashings | <ul style="list-style-type: none"> • All curb flashings, including cricket details, must be flashed with at least a 12 inch (305 mm) width of HydroStop® PremiumCoat® Butter Grade Flashing with fabric. • Encapsulate all fasteners using HydroStop® PremiumCoat® Butter Grade Flashing with fabric. Do not bridge fasteners. • Fabric must be cut around all fasteners so it lies flat. |
| Penetrations | <ul style="list-style-type: none"> • HydroStop® PremiumCoat® Butter Grade Flashing with fabric must be applied around the base of all penetrations, extending at least 6 inches (152 mm) up the vertical and 6 inches (152 mm) onto the base. • Cut the fabric to accommodate the shape of the penetration. |
| Skylights | <ul style="list-style-type: none"> • Curb skylights must be treated in the same fashion as curb flashings. • After flashing work has been completed and the coating has cured, treat deteriorated fiberglass skylight panels with United Coatings™ Acrysheen Sealer. |
| Pitch Pans | <ul style="list-style-type: none"> • Pitch pans must be capped with sheet metal so that they may be sealed with HydroStop® PremiumCoat® Butter Grade Flashing. |
| Condensate Lines | <ul style="list-style-type: none"> • Condensate lines must be installed from HVAC units to gutters as part of the overall drainage system. The type of piping used for condensate lines may vary depending on local building codes. |

Adhesion Testing

Adhesion testing is generally performed to verify the suitability of any substrate to receive a liquid-applied coating system. It is the responsibility of the roofing contractor to determine the suitability of the substrate prior to the application of a liquid-applied coating system.

When adhesion tests are conducted:

- Test patches shall be labeled and photographed to document adhesion results.
- Installer can consult with GAF's Technical Services Department (800-766-3411) concerning all adhesion test results.

GAF recommends either of the following test methods:

| Test Method #1: Test Patches | |
|-------------------------------------|---|
| Overview | Patch testing gives information about the bond strength created between a liquid-applied product and a substrate. |
| Preparation | <ul style="list-style-type: none"> • Installer should prepare no fewer than three (3) test patches at different locations on the roof for all questionable roof substrates to verify adhesion of the liquid-applied coating system. |
| Test Method | <ul style="list-style-type: none"> • Minimum test patch size should be 1 square foot (0.09 square meter). • Allow at least seven (7) full 24 hour days of drying time after application of the test patches before checking adhesion. • Check adhesion by slicing an "X" (approx. 6" [152 mm] in size) near the center of the test patch. • Using a spatula, try to remove the material at the center of the "X". |
| Acceptable Result: | <ul style="list-style-type: none"> • Test patches that show good adhesion will release or chip away from the surface in very small pieces. |
| Unacceptable Result: | <ul style="list-style-type: none"> • Test patches that peel off of the surface and show the underlying substrate reflect poor adhesion. |

| Test Method #2: Field Peel Adhesion (Alternate to Test Patches) | |
|--|--|
| Overview | ASTM D903 “Peel Adhesion” is found in all roof coating standards and is especially well-suited to field testing with elastomeric materials. Primers and enamels may also be evaluated by a similar test called ASTM D3359 “Tape Adhesion.” It may also be important to run the test wet; this is called “wet adhesion.” |
| Preparation¹⁰¹ | <ul style="list-style-type: none"> • Make a mock-up of the intended coating system on the existing roof surface. • Duplicate any mechanical surface preparation. • Simulate cleaners and power washing. <ul style="list-style-type: none"> • A worn Scotch-Brite® cleaning pad makes a good power washing simulation. • Prime as specified. • Apply a layer of elastomeric coating to the substrate. • Installer should prepare no fewer than three (3) test patches at different locations on the roof for all questionable roof substrates to verify adhesion of the liquid-applied coating system. |
| Test Method  | <ul style="list-style-type: none"> • Wet about 6” (152 mm) of a pre-cut 1” (25 mm) wide by 12” (305 mm) long fabric strip with the coating. • Allow the remaining 6” (152 mm) of the fabric to be available to pull on the test sample. • Apply another layer of coating to encapsulate the wetted section of fabric. • Allow to dry. This can be anywhere from 24 hours to 2 weeks. <ul style="list-style-type: none"> • In warm weather, 1 day may be sufficient. • In cold weather, 5 days is often required. • The standard practice is 1 week. • Soak prior to testing (best practice). <ul style="list-style-type: none"> • One hour is usually sufficient; use wet rag and cover with a bucket lid or plastic. • Some coatings like polyvinylidene difluoride (PVDF) or silicone may take longer. |
| Optional | <ul style="list-style-type: none"> • Pre-cut 1” (25 mm) wide strips of butyl tape work faster and can be used in a post installation inspection. A “wet adhesion” version can be accomplished by soaking the roof area first as indicated above, but follow with a towel dry, and then use butyl tape to run the pull test. The butyl tape can be easier to use with a gauge as it will bond to itself making a perfect loop. |
| Quantitative Evaluation (best practice) | Qualitative Evaluation |
| <ul style="list-style-type: none"> • Use a force gauge such as a digital fish scale or trigger pressure gauge. • A loop, staple or clamp may be used to hold the fabric in the gauge. • Pull slowly; the peak value should be above 2 pounds/ inch (2 PLI). | <p>Excellent: Coating tears up the substrate (cohesive failure of substrate)</p> <p>Very Good: Most of the coating remains on the substrate (cohesive failure of coating)</p> <p>Good: Some coating remains on the substrate (partial cohesive failure of coating)</p> <p>Fair: Coating pulls clean but pulls below 2 pounds/ inch (2 PLI)</p> <p>Poor: Test strip comes off easily and cleanly (complete cohesive failure of coating)</p> |

Section 3

Quick Specs

HydroStop® PremiumCoat® Quick Spec Directory

| Spec Number | Substrate Specification | Page # |
|-------------|--|--------|
| HS-1 | Metal – HydroStop® PremiumCoat® | 29 |
| HS-2 | Smooth & Granulated Asphaltic – Hydrostop™ PremiumCoat® | 30 |
| HS-3 | TPO – HydroStop® PremiumCoat® | 31 |
| HS-4 | PVC – HydroStop® PremiumCoat® | 32 |
| HS-5 | Hypalon® - HydroStop® PremiumCoat® | 33 |
| HS-6 | EPDM – HydroStop® PremiumCoat® | 34 |
| HS-7 | Structural Concrete – HydroStop® PremiumCoat® | 35 |
| HS-8 | Corrugated Structural Transite Panel – HydroStop® PremiumCoat® | 36 |
| HS-9 | ISO – HydroStop® PremiumCoat® | 37 |
| HS-10 | Gypsum (DensDeck & SecuRock) – HydroStop® PremiumCoat® | 38 |
| HS-11 | Warranty Extension/Renewal – HydroStop® PremiumCoat® | 39 |
| HS-12 | Metal – HydroStop® PremiumCoat® + Kymax | 40 |
| HS-13 | Non-Metal – HydroStop® PremiumCoat® + Kymax | 41 |

Quick Specs are abbreviated specifications and are not meant to replace detailed specifications. Complete 3-part CSI System Specifications are available at www.gaf.com.

QUICK SPEC

METAL – HYDROSTOP® PREMIUMCOAT® (HS-1)

NOTE: The following “Quick Spec” is an abbreviated specification and is not meant to replace the detailed specification. Read the entire 3-Part CSI System Specification prior to starting the project. Specifications are available at www.gaf.com.

Method

- Use GAF Roof Brush to apply HydroStop® PremiumCoat® Foundation Coat
- Spray, roller, or brush apply HydroStop® PremiumCoat® Finish Coat

Requirements

- Roof must be clean, dry, and tight.
- Adhesion test required to ensure proper adhesion to substrate(s).
- Apply at 50°F (10°C) and rising with no rain, dew, fog or freezing temperatures in forecast for 24 hours.
- GAF recommends that the surface temperature be at or less than 110°F (43°C) during application.

Application Instructions

1. Before applying HydroStop® PremiumCoat®, an adhesion test is required to ensure an adhesion minimum of 2.0 pounds per linear inch (PLI). Test patches to be applied with rates listed below.
2. Tighten and/or replace existing fasteners.
3. Power wash roof to ensure it is free of dirt, debris, oil, and other contaminants that could negatively affect adhesion. United Cleaning Concentrate (UCC) is recommended to clean the roof. Allow roof to completely dry.
4. Install crickets to divert water and complete other necessary sheet metal repairs.
5. Prime rusty areas with Acrylex 400 Primer or StableRust Rust-Inhibiting Primer. For severe rust, prime area with Lock-Down Primer.
6. Treat all seams.
7. Treat all roof penetrations, skylight curbs & rake edges with HydroStop® PremiumCoat® Butter Grade Flashing with fabric.
8. Encapsulate fasteners with HydroStop® HydroCap Fastener Caps or HydroStop® PremiumCoat® Butter Grade Flashing.
9. Apply HydroStop® PremiumCoat® Foundation Coat and Finish Coat per the chart below.

| SEAMS & DETAILS HYDROSTOP® PREMIUMCOAT® SYSTEM | | | |
|--|------------------------------------|----------------|-------------|
| Treatment Type | Product | Total (Gal/Sq) | DFT* (mils) |
| 3-Coursed Rates | HydroStop® Butter Grade and Fabric | 4.0 | 43 |
| Flashing Grade Only Rates | HydroStop® Butter Grade | 2.0 | 19 |

| METAL HYDROSTOP® PREMIUMCOAT® SYSTEM | | | | | | | | | | | | |
|---|---------------------------|----------------|-------------|-------------------|-------------------|-------------------|----------------|-------------|----------------|-------------|-----------------|-----------------|
| | Foundation Coat | | | Finish Coat | | | | | System | | Warranty | |
| | Area | Total (Gal/Sq) | DFT* (mils) | 1st Coat (Gal/Sq) | 2nd Coat (Gal/Sq) | 3rd Coat (Gal/Sq) | Total (Gal/Sq) | DFT* (mils) | Total (Gal/Sq) | DFT* (mils) | Emerald Pledge™ | Diamond Pledge™ |
| 10 Year | Field of Roof (no fabric) | N/A | 0 | 0.75 | 0.75 | | 1.50 | 13 | 1.50 | 13 | Yes | Yes |
| 15 Year | Field of Roof (no fabric) | N/A | 0 | 1.00 | 1.00 | | 2.00 | 17 | 2.00 | 17 | Yes | Yes |
| 20 Year | Field of Roof (no fabric) | N/A | 0 | 1.00 | 1.00 | 1.00 | 3.00 | 25 | 3.00 | 25 | Yes | Yes |

* Dry Film Thickness (DFT) is rounded to nearest mil, and is theoretical. Actual DFT will vary dependent on substrate profile, application technique and waste factor.

Note: DFT for 3-coursed rates includes 6 mils for the fabric.

QUICK SPEC

SMOOTH & GRANULATED ASPHALTIC – HYDROSTOP® PREMIUMCOAT® (HS-2)

NOTE: The following “Quick Spec” is an abbreviated specification and is not meant to replace the detailed specification. Read the entire 3-Part CSI System Specification prior to starting the project. Specifications are available at www.gaf.com.

Method

- Use GAF Roof Brush to apply HydroStop® PremiumCoat® Foundation Coat
- Spray, roller, or brush apply HydroStop® PremiumCoat® Finish Coat

Requirements

- Moisture survey required.
- Roof must be clean, dry, and tight.
- Adhesion test required to ensure proper adhesion to substrate(s).
- Apply at 50°F (10°C) and rising with no rain, dew, fog or freezing temperatures in forecast for 24 hours.
- GAF recommends that the surface temperature be at or less than 110°F (43°C) during application.
- GAF recommends that new asphaltic membranes and repairs age at least 30 days; 90+ days is ideal.
- Do not apply over gravel surfaced asphaltic substrate.

Application Instructions

1. Before applying the HydroStop® PremiumCoat® System, an adhesion test is required to ensure an adhesion of a minimum of 2.0 PLI. Test patches to be applied with system rates listed below.
2. Conduct moisture survey and remove/replace all wet areas.
3. Repair membrane including seams, penetrations, flashings, curbs, and terminations with like materials.
4. Power wash roof to ensure it is free of dirt, debris, oil, and other contaminants that could negatively affect adhesion. United Cleaning Concentrate (UCC) is recommended to clean the roof. Allow roof to completely dry.
5. Prime with UniBase Primer.
6. Treat “alligatored” areas or surface cracks.
7. Treat all roof penetrations, drains, curbs, and scuppers.
8. All loose seams must be 3-coursed with flashing grade and fabric.
9. Apply HydroStop® PremiumCoat® Foundation Coat and Finish Coat per the chart below.

| SEAMS & DETAILS HYDROSTOP® PREMIUMCOAT® SYSTEM | | | |
|--|------------------------------------|----------------|-------------|
| Treatment Type | Product | Total (Gal/Sq) | DFT* (mils) |
| 3-Coursed Rates | HydroStop® Butter Grade and Fabric | 4.0 | 43 |
| Flashing Grade Only Rates | HydroStop® Butter Grade | 2.0 | 19 |

| SMOOTH AND GRANULATED ASPHALTIC HYDROSTOP® PREMIUMCOAT® SYSTEM | | | | | | | | | | | |
|---|-------------------------------|-------------|-------------------|-------------------|-------------------|----------------|-------------|----------------|-------------|-----------------|-----------------|
| | Foundation Coat (with fabric) | | Finish Coat | | | | | System | | Warranty | |
| | Total (Gal/Sq) | DFT* (mils) | 1st Coat (Gal/Sq) | 2nd Coat (Gal/Sq) | 3rd Coat (Gal/Sq) | Total (Gal/Sq) | DFT* (mils) | Total (Gal/Sq) | DFT* (mils) | Emerald Pledge™ | Diamond Pledge™ |
| 10 Year | 2.5 | 27 | 0.75 | 0.75 | | 1.50 | 13 | 4.00 | 40 | Yes | Yes |
| 15 Year | 2.5 | 27 | 1.00 | 1.00 | | 2.00 | 17 | 4.50 | 44 | Yes | Yes |
| 20 Year | 2.5 | 27 | 1.00 | 1.00 | 1.00 | 3.00 | 25 | 5.50 | 52 | Yes | Yes |

* Dry Film Thickness (DFT) is rounded to nearest mil, and is theoretical. Actual DFT will vary dependent on substrate profile, application technique and waste factor.

Note: DFT for 3-coursed rates includes 6 mils for the fabric.

QUICK SPEC

TPO – HYDROSTOP® PREMIUMCOAT® (HS-3)

NOTE: The following “Quick Spec” is an abbreviated specification and is not meant to replace the detailed specification. Read the entire 3-Part CSI System Specification prior to starting the project. Specifications are available at www.gaf.com.

Method

- Use GAF Roof Brush to apply HydroStop® PremiumCoat® Foundation Coat
- Spray, roller, or brush apply HydroStop® PremiumCoat® Finish Coat

Requirements

- Moisture survey required.
- Roof must be clean, dry, and tight.
- Adhesion test required to ensure proper adhesion to substrate(s).
- Apply at 50°F (10°C) and rising with no rain, dew, fog or freezing temperatures in forecast for 24 hours.
- GAF recommends that the surface temperature be at or less than 110°F (43°C) during application.

Application Instructions

1. Before applying the HydroStop® PremiumCoat® System, an adhesion test is required to ensure an adhesion of a minimum of 2.0 PLI. Test patches to be applied with system rates listed below.
2. Conduct moisture survey and remove/replace all wet areas.
3. Repair membrane including seams, penetrations, flashings, curbs, and terminations with like materials.
4. Power wash roof to ensure it is free of dirt, debris, oil, and other contaminants that could negatively affect adhesion. United Cleaning Concentrate (UCC) is recommended to clean the roof. Allow roof to completely dry.
5. Prime with TPO Red Primer.
6. Treat all roof penetrations, drains, curbs, and scuppers.
7. All loose seams must be 3-coursed with flashing grade and fabric.
8. Apply HydroStop® PremiumCoat® Foundation Coat and Finish Coat per the chart below.

| SEAMS & DETAILS HYDROSTOP® PREMIUMCOAT® SYSTEM | | | |
|--|------------------------------------|----------------|-------------|
| Treatment Type | Product | Total (Gal/Sq) | DFT* (mils) |
| 3-Coursed Rates | HydroStop® Butter Grade and Fabric | 4.0 | 43 |
| Flashing Grade Only Rates | HydroStop® Butter Grade | 2.0 | 19 |

| TPO HYDROSTOP® PREMIUMCOAT® SYSTEM | | | | | | | | | | | |
|---------------------------------------|-------------------------------|-------------|-------------------|-------------------|-------------------|----------------|-------------|----------------|-------------|-----------------|-----------------|
| | Foundation Coat (with fabric) | | Finish Coat | | | | | System | | Warranty | |
| | Total (Gal/Sq) | DFT* (mils) | 1st Coat (Gal/Sq) | 2nd Coat (Gal/Sq) | 3rd Coat (Gal/Sq) | Total (Gal/Sq) | DFT* (mils) | Total (Gal/Sq) | DFT* (mils) | Emerald Pledge™ | Diamond Pledge™ |
| 10 Year | 2.5 | 27 | 0.75 | 0.75 | | 1.50 | 13 | 4.00 | 40 | Yes | Yes |
| 15 Year | 2.5 | 27 | 1.00 | 1.00 | | 2.00 | 17 | 4.50 | 44 | Yes | Yes |
| 20 Year | 2.5 | 27 | 1.00 | 1.00 | 1.00 | 3.00 | 25 | 5.50 | 52 | Yes | Yes |

* Dry Film Thickness (DFT) is rounded to nearest mil, and is theoretical. Actual DFT will vary dependent on substrate profile, application technique and waste factor.

Note: DFT for 3-coursed rates includes 6 mils for the fabric.

QUICK SPEC

PVC – HYDROSTOP® PREMIUMCOAT® (HS-4)

NOTE: The following “Quick Spec” is an abbreviated specification and is not meant to replace the detailed specification. Read the entire 3-Part CSI System Specification prior to starting the project. Specifications are available at www.gaf.com.

Method

- Use GAF Roof Brush to apply HydroStop® PremiumCoat® Foundation Coat
- Spray, roller, or brush apply HydroStop® PremiumCoat® Finish Coat

Requirements

- Moisture survey required.
- Roof must be clean, dry, and tight.
- Adhesion test required to ensure proper adhesion to substrate(s).
- Apply at 50°F (10°C) and rising with no rain, dew, fog or freezing temperatures in forecast for 24 hours.
- GAF recommends that the surface temperature be at or less than 110°F (43°C) during application.

Application Instructions

1. Before applying the HydroStop® PremiumCoat® System, an adhesion test is required to ensure an adhesion of a minimum of 2.0 PLI. Test patches to be applied with system rates listed below.
2. Conduct moisture survey and remove/replace all wet areas.
3. Repair membrane including seams, penetrations, flashings, curbs, and terminations with like materials.
4. Power wash roof to ensure it is free of dirt, debris, oil, and other contaminants that could negatively affect adhesion. United Cleaning Concentrate (UCC) is recommended to clean the roof. Allow roof to completely dry.
5. All loose seams must be 3-coursed with flashing grade and fabric.
6. Treat all roof penetrations, drains, curbs, and scuppers.
7. Apply HydroStop® PremiumCoat® Foundation Coat and Finish Coat per the chart below.

| SEAMS & DETAILS HYDROSTOP® PREMIUMCOAT® SYSTEM | | | |
|--|------------------------------------|----------------|-------------|
| Treatment Type | Product | Total (Gal/Sq) | DFT* (mils) |
| 3-Coursed Rates | HydroStop® Butter Grade and Fabric | 4.0 | 43 |
| Flashing Grade Only Rates | HydroStop® Butter Grade | 2.0 | 19 |

| PVC HYDROSTOP® PREMIUMCOAT® SYSTEM | | | | | | | | | | | |
|---------------------------------------|-------------------------------|-------------|-------------------|-------------------|-------------------|----------------|-------------|----------------|-------------|-----------------|-----------------|
| | Foundation Coat (with fabric) | | Finish Coat | | | | | System | | Warranty | |
| | Total (Gal/Sq) | DFT* (mils) | 1st Coat (Gal/Sq) | 2nd Coat (Gal/Sq) | 3rd Coat (Gal/Sq) | Total (Gal/Sq) | DFT* (mils) | Total (Gal/Sq) | DFT* (mils) | Emerald Pledge™ | Diamond Pledge™ |
| 10 Year | 2.5 | 27 | 0.75 | 0.75 | | 1.50 | 13 | 4.00 | 40 | Yes | Yes |
| 15 Year | 2.5 | 27 | 1.00 | 1.00 | | 2.00 | 17 | 4.50 | 44 | Yes | Yes |
| 20 Year | 2.5 | 27 | 1.00 | 1.00 | 1.00 | 3.00 | 25 | 5.50 | 52 | Yes | Yes |

* Dry Film Thickness (DFT) is rounded to nearest mil, and is theoretical. Actual DFT will vary dependent on substrate profile, application technique and waste factor.

Note: DFT for 3-coursed rates includes 6 mils for the fabric.

QUICK SPEC

HYPALON® - HYDROSTOP® PREMIUMCOAT® (HS-5)

NOTE: The following “Quick Spec” is an abbreviated specification and is not meant to replace the detailed specification. Read the entire 3-Part CSI System Specification prior to starting the project. Specifications are available at www.gaf.com.

Method

- Use GAF Roof Brush to apply HydroStop® PremiumCoat® Foundation Coat
- Spray, roller, or brush apply HydroStop® PremiumCoat® Finish Coat

Requirements

- Moisture survey required.
- Roof must be clean, dry, and tight.
- Adhesion test required to ensure proper adhesion to substrate(s).
- Apply at 50°F (10°C) and rising with no rain, dew, fog or freezing temperatures in forecast for 24 hours.
- GAF recommends that the surface temperature be at or less than 110°F (43°C) during application.

Application Instructions

1. Before applying the HydroStop® PremiumCoat® System, an adhesion test is required to ensure an adhesion of a minimum of 2.0 PLI. Test patches to be applied with system rates listed below.
2. Conduct moisture survey and remove/replace all wet areas.
3. Repair membrane including seams, penetrations, flashings, curbs, and terminations with like materials.
4. Power wash roof to ensure it is free of dirt, debris, oil, and other contaminants that could negatively affect adhesion. United Cleaning Concentrate (UCC) is recommended to clean the roof. Allow roof to completely dry.
5. Treat all roof penetrations, drains, curbs, and scuppers.
6. All loose seams must be 3-coursed with flashing grade and fabric.
7. Apply HydroStop® PremiumCoat® Foundation Coat and Finish Coat per the chart below.

| SEAMS & DETAILS HYDROSTOP® PREMIUMCOAT® SYSTEM | | | |
|--|------------------------------------|----------------|-------------|
| Treatment Type | Product | Total (Gal/Sq) | DFT* (mils) |
| 3-Coursed Rates | HydroStop® Butter Grade and Fabric | 4.0 | 43 |
| Flashing Grade Only Rates | HydroStop® Butter Grade | 2.0 | 19 |

| HYPALON® HYDROSTOP® PREMIUMCOAT® SYSTEM | | | | | | | | | | | |
|--|-------------------------------|-------------|-------------------|-------------------|-------------------|----------------|-------------|----------------|-------------|-----------------|-----------------|
| | Foundation Coat (with fabric) | | Finish Coat | | | | | System | | Warranty | |
| | Total (Gal/Sq) | DFT* (mils) | 1st Coat (Gal/Sq) | 2nd Coat (Gal/Sq) | 3rd Coat (Gal/Sq) | Total (Gal/Sq) | DFT* (mils) | Total (Gal/Sq) | DFT* (mils) | Emerald Pledge™ | Diamond Pledge™ |
| 10 Year | 2.5 | 27 | 0.75 | 0.75 | | 1.50 | 13 | 4.00 | 40 | Yes | Yes |
| 15 Year | 2.5 | 27 | 1.00 | 1.00 | | 2.00 | 17 | 4.50 | 44 | Yes | Yes |
| 20 Year | 2.5 | 27 | 1.00 | 1.00 | 1.00 | 3.00 | 25 | 5.50 | 52 | Yes | Yes |

* Dry Film Thickness (DFT) is rounded to nearest mil, and is theoretical. Actual DFT will vary dependent on substrate profile, application technique and waste factor.

Note: DFT for 3-coursed rates includes 6 mils for the fabric.

QUICK SPEC

EPDM – HYDROSTOP® PREMIUMCOAT® (HS-6)

NOTE: The following “Quick Spec” is an abbreviated specification and is not meant to replace the detailed specification. Read the entire 3-Part CSI System Specification prior to starting the project. Specifications are available at www.gaf.com.

Method

- Use GAF Roof Brush to apply HydroStop® PremiumCoat® Foundation Coat
- Spray, roller, or brush apply HydroStop® PremiumCoat® Finish Coat

Requirements

- Moisture survey required.
- Roof must be clean, dry, and tight.
- Adhesion test required to ensure proper adhesion to substrate(s).
- Apply at 50°F (10°C) and rising with no rain, dew, fog or freezing temperatures in forecast for 24 hours.
- GAF recommends that the surface temperature be at or less than 110°F (43°C) during application.

Application Instructions

1. Before applying the HydroStop® PremiumCoat® System, an adhesion test is required to ensure an adhesion of a minimum of 2.0 PLI. Test patches to be applied with system rates listed below.
2. Conduct moisture survey and remove/replace all wet areas.
3. Repair membrane including seams, penetrations, flashings, curbs, and terminations with like materials.
4. Clean roof to ensure it is free of dirt, debris, oil, and other contaminants that could negatively affect adhesion.
5. Prime using either Adhere-It II or CleanAct Rinsable Primer.
6. Treat all roof penetrations, drains, curbs, and scuppers.
7. All loose seams must be 3-coursed with flashing grade and fabric.
8. Apply HydroStop® PremiumCoat® Foundation Coat and HydroStop® PremiumCoat® Finish Coat per the chart below.

| SEAMS & DETAILS HYDROSTOP® PREMIUMCOAT® SYSTEM | | | |
|--|------------------------------------|----------------|-------------|
| Treatment Type | Product | Total (Gal/Sq) | DFT* (mils) |
| 3-Coursed Rates | HydroStop® Butter Grade and Fabric | 4.0 | 43 |
| Flashing Grade Only Rates | HydroStop® Butter Grade | 2.0 | 19 |

| EPDM HYDROSTOP® PREMIUMCOAT® SYSTEM | | | | | | | | | | | |
|--|-------------------------------|-------------|-------------------|-------------------|-------------------|----------------|-------------|----------------|-------------|-----------------|-----------------|
| | Foundation Coat (with fabric) | | Finish Coat | | | | | System | | Warranty | |
| | Total (Gal/Sq) | DFT* (mils) | 1st Coat (Gal/Sq) | 2nd Coat (Gal/Sq) | 3rd Coat (Gal/Sq) | Total (Gal/Sq) | DFT* (mils) | Total (Gal/Sq) | DFT* (mils) | Emerald Pledge™ | Diamond Pledge™ |
| 10 Year | 2.5 | 27 | 0.75 | 0.75 | | 1.50 | 13 | 4.00 | 40 | Yes | Yes |
| 15 Year | 2.5 | 27 | 1.00 | 1.00 | | 2.00 | 17 | 4.50 | 44 | Yes | Yes |
| 20 Year | 2.5 | 27 | 1.00 | 1.00 | 1.00 | 3.00 | 25 | 5.50 | 52 | Yes | Yes |

* Dry Film Thickness (DFT) is rounded to nearest mil, and is theoretical. Actual DFT will vary dependent on substrate profile, application technique and waste factor.

Note: DFT for 3-coursed rates includes 6 mils for the fabric.

QUICK SPEC

STRUCTURAL CONCRETE – HYDROSTOP® PREMIUMCOAT® (HS-7)

NOTE: The following “Quick Spec” is an abbreviated specification and is not meant to replace the detailed specification. Read the entire 3-Part CSI System Specification prior to starting the project. Specifications are available at www.gaf.com.

Method

- Use GAF Roof Brush to apply HydroStop® PremiumCoat® Foundation Coat
- Spray, roller, or brush apply HydroStop® PremiumCoat® Finish Coat

Requirements

- Moisture survey required.
- Roof must be clean, dry, and tight.
- Adhesion test required to ensure proper adhesion to substrate(s).
- Apply at 50°F (10°C) and rising with no rain, dew, fog or freezing temperatures in forecast for 24 hours.
- GAF recommends that the surface temperature be at or less than 110°F (43°C) during application.
- Concrete must be fully cured (typically 28 days).

Application Instructions

1. Before applying the HydroStop® PremiumCoat® System, an adhesion test is required to ensure an adhesion of a minimum of 2.0 PLI. Test patches to be applied with system rates listed below.
2. Conduct moisture survey to ensure concrete contains less than 8% moisture.
3. Repair or replace damaged or deteriorated sections with like materials, allowing cementitious products to cure properly.
4. Power wash roof to ensure it is free of dirt, debris, oil, and other contaminants that could negatively affect adhesion. United Cleaning Concentrate (UCC) is recommended to clean the roof. Allow roof to completely dry.
5. Prime with Epoxy Primer.
6. Treat structural joints with backer rod and compatible sealant.
7. Control joints in excess of 1/16” (1.6mm) shall also be caulked with a compatible caulk.
8. Treat all roof penetrations, drains, curbs, caulked control joints, and scuppers.
9. Apply HydroStop® PremiumCoat® Foundation Coat and Finish Coat per the chart below.

| SEAMS & DETAILS HYDROSTOP® PREMIUMCOAT® SYSTEM | | | |
|--|------------------------------------|----------------|-------------|
| Treatment Type | Product | Total (Gal/Sq) | DFT* (mils) |
| 3-Coursed Rates | HydroStop® Butter Grade and Fabric | 4.0 | 43 |
| Flashing Grade Only Rates | HydroStop® Butter Grade | 2.0 | 19 |

| STRUCTURAL CONCRETE HYDROSTOP® PREMIUMCOAT® SYSTEM | | | | | | | | | | | |
|---|-------------------------------|-------------|-------------------|-------------------|-------------------|----------------|-------------|----------------|-------------|-----------------|-----------------|
| | Foundation Coat (with fabric) | | Finish Coat | | | | | System | | Warranty | |
| | Total (Gal/Sq) | DFT* (mils) | 1st Coat (Gal/Sq) | 2nd Coat (Gal/Sq) | 3rd Coat (Gal/Sq) | Total (Gal/Sq) | DFT* (mils) | Total (Gal/Sq) | DFT* (mils) | Emerald Pledge™ | Diamond Pledge™ |
| 10 Year | 2.5 | 27 | 0.75 | 0.75 | | 1.50 | 13 | 4.00 | 40 | Yes | Yes |
| 15 Year | 2.5 | 27 | 1.00 | 1.00 | | 2.00 | 17 | 4.50 | 44 | Yes | Yes |
| 20 Year | 2.5 | 27 | 1.00 | 1.00 | 1.00 | 3.00 | 25 | 5.50 | 52 | Yes | Yes |

* Dry Film Thickness (DFT) is rounded to nearest mil, and is theoretical. Actual DFT will vary dependent on substrate profile, application technique and waste factor.

Note: DFT for 3-coursed rates includes 6 mils for the fabric.

QUICK SPEC

CORRUGATED STRUCTURAL TRANSITE PANELS – HYDROSTOP® PREMIUMCOAT® (HS-8)

NOTE: The following “Quick Spec” is an abbreviated specification and is not meant to replace the detailed specification. Read the entire 3-Part CSI System Specification prior to starting the project. Specifications are available at www.gaf.com.

- Method**
- Use GAF Roof Brush to apply HydroStop® PremiumCoat® Foundation Coat
 - Spray, roller, or brush apply HydroStop® PremiumCoat® Finish Coat

- Requirements**
- Moisture survey recommended for all non-metal roofs.
 - Roof must be clean, dry, and tight.
 - Adhesion test required to ensure proper adhesion to substrate(s).
 - Apply at 50°F (10°C) and rising with no rain, dew, fog or freezing temperatures in forecast for 24 hours.
 - GAF recommends that the surface temperature be at or less than 110°F (43°C) during application.

- Application Instructions**
1. Before applying the HydroStop® PremiumCoat® System, an adhesion test is required to ensure an adhesion of a minimum of 2.0 PLI. Test patches to be applied with system rates listed below.
 2. Conduct moisture survey and remove/replace all wet areas
 3. Repair or replace damaged or deteriorated sections with like materials, allowing cementitious products to cure properly.
 4. Power wash roof to ensure it is free of dirt, debris, oil, and other contaminants that could negatively affect adhesion. United Cleaning Concentrate (UCC) is recommended to clean the roof. Allow to completely dry.
 5. Prime with Epoxy Primer.
 6. Treat transite gaps in excess of 1/16” (1.6mm) with a compatible caulk.
 7. Treat all roof penetrations, drains, curbs, caulked gaps, and scuppers.
 8. Apply HydroStop® PremiumCoat® Foundation Coat and Finish Coat per the chart below.

| SEAMS & DETAILS HYDROSTOP® PREMIUMCOAT® SYSTEM | | | |
|--|------------------------------------|----------------|-------------|
| Treatment Type | Product | Total (Gal/Sq) | DFT* (mils) |
| 3-Coursed Rates | HydroStop® Butter Grade and Fabric | 4.0 | 43 |
| Flashing Grade Only Rates | HydroStop® Butter Grade | 2.0 | 19 |

| CORRUGATED STRUCTURAL TRANSITE PANEL HYDROSTOP® PREMIUMCOAT® SYSTEM | | | | | | | | | | | |
|--|-------------------------------|-------------|-------------------|-------------------|-------------------|----------------|-------------|----------------|-------------|-----------------|-----------------|
| | Foundation Coat (with fabric) | | Finish Coat | | | | | System | | Warranty | |
| | Total (Gal/Sq) | DFT* (mils) | 1st Coat (Gal/Sq) | 2nd Coat (Gal/Sq) | 3rd Coat (Gal/Sq) | Total (Gal/Sq) | DFT* (mils) | Total (Gal/Sq) | DFT* (mils) | Emerald Pledge™ | Diamond Pledge™ |
| 10 Year | 2.5 | 27 | 0.75 | 0.75 | | 1.50 | 13 | 4.00 | 40 | Yes | Yes |
| 15 Year | 2.5 | 27 | 1.00 | 1.00 | | 2.00 | 17 | 4.50 | 44 | Yes | Yes |
| 20 Year | 2.5 | 27 | 1.00 | 1.00 | 1.00 | 3.00 | 25 | 5.50 | 52 | Yes | Yes |

* Dry Film Thickness (DFT) is rounded to nearest mil, and is theoretical. Actual DFT will vary dependent on substrate profile, application technique and waste factor.

Note: DFT for 3-coursed rates includes 6 mils for the fabric.

IMPORTANT NOTE: Corrugated structural transite panels may contain asbestos. Follow all applicable local, state and federal regulations concerning asbestos. Under no circumstances does GAF have any liability for any damages, costs or expenses arising out of or associated with the pre-existing presence of asbestos-containing materials or any other allegedly hazardous substances or materials upon on the roof to which the new GAF roofing materials are being applied.

QUICK SPEC

POLYISOCYANURATE (ISO) – HYDROSTOP® PREMIUMCOAT® (HS-9)

NOTE: The following “Quick Spec” is an abbreviated specification and is not meant to replace the detailed specification. Read the entire 3-Part CSI System Specification prior to starting the project. Specifications are available at www.gaf.com.

Method

- Use GAF Roof Brush to apply HydroStop® PremiumCoat® Foundation Coat
- Spray, roller, or brush apply HydroStop® PremiumCoat® Finish Coat

Requirements

- Roof must be clean, dry, and tight.
- Adhesion test required to ensure proper adhesion to substrate(s).
- **Recover over an existing roof:** one (1) layer of ISO is required. Refer to local building code for further insulation requirements.
- **New construction or tear-off:** one (1) layer of ISO & minimum 1/4” (6.35 mm) gypsum roof coverboard OR two (2) layers of fully adhered staggered ISO. If the top layer is mechanically attached, plates must be encapsulated with Butter Grade Flashing.
- Apply at 50°F (10°C) and rising with no rain, dew, fog or freezing temperatures in forecast for 24 hours.
- GAF recommends that the surface temperature be at or less than 110°F (43°C) during application.

Application Instructions

1. Before applying the HydroStop® PremiumCoat® System, an adhesion test is required to ensure an adhesion of a minimum of 2.0 PLI. Test patches to be applied with system rates listed below.
2. Ensure roof is free of dirt, debris, oil, and other contaminants that could negatively affect adhesion.
3. All seams must be treated with flashing grade and fabric.
4. Apply HydroStop® PremiumCoat® Foundation Coat and Finish Coat per the chart below.

| SEAMS & DETAILS HYDROSTOP® PREMIUMCOAT® SYSTEM | | | |
|--|------------------------------------|----------------|-------------|
| Treatment Type | Product | Total (Gal/Sq) | DFT* (mils) |
| 3-Coursed Rates | HydroStop® Butter Grade and Fabric | 4.0 | 43 |
| Flashing Grade Only Rates | HydroStop® Butter Grade | 2.0 | 19 |

| POLYISOCYANURATE (ISO) HYDROSTOP® PREMIUMCOAT® SYSTEM | | | | | | | | | | | |
|--|-------------------------------|-------------|-------------------|-------------------|-------------------|----------------|-------------|----------------|-------------|-----------------|-----------------|
| | Foundation Coat (with fabric) | | Finish Coat | | | | | System | | Warranty | |
| | Total (Gal/Sq) | DFT* (mils) | 1st Coat (Gal/Sq) | 2nd Coat (Gal/Sq) | 3rd Coat (Gal/Sq) | Total (Gal/Sq) | DFT* (mils) | Total (Gal/Sq) | DFT* (mils) | Emerald Pledge™ | Diamond Pledge™ |
| 10 Year | 2.5 | 27 | 0.75 | 0.75 | | 1.50 | 13 | 4.00 | 40 | Yes | Yes |
| 15 Year | 2.5 | 27 | 1.00 | 1.00 | | 2.00 | 17 | 4.50 | 44 | Yes | Yes |
| 20 Year | 2.5 | 27 | 1.00 | 1.00 | 1.00 | 3.00 | 25 | 5.50 | 52 | Yes | Yes |

* Dry Film Thickness (DFT) is rounded to nearest mil, and is theoretical. Actual DFT will vary dependent on substrate profile, application technique and waste factor.

Note: DFT for 3-coursed rates includes 6 mils for the fabric.

QUICK SPEC

GYPNUM ROOF BOARD (Densdeck® & Securock®) – HYDROSTOP® PREMIUMCOAT® (HS-10)

NOTE: The following “Quick Spec” is an abbreviated specification and is not meant to replace the detailed specification. Read the entire 3-Part CSI System Specification prior to starting the project. Specifications are available at www.gaf.com.

Method

- Use GAF Roof Brush to apply HydroStop® PremiumCoat® Foundation Coat
- Spray, roller, or brush apply HydroStop® PremiumCoat® Finish Coat

Requirements

- Roof must be clean, dry, and tight.
- Adhesion test required to ensure proper adhesion to substrate(s).
- If mechanically attached, plates must be encapsulated with Butter Grade Flashing.
- Apply at 50°F (10°C) and rising with no rain, dew, fog or freezing temperatures in forecast for 24 hours.
- GAF recommends that the surface temperature be at or less than 110°F (43°C) during application.

Application Instructions

1. Before applying the HydroStop® PremiumCoat® System, an adhesion test is required to ensure an adhesion of a minimum of 2.0 PLI. Test patches to be applied with system rates listed below.
2. Ensure roof is free of dirt, debris, oil, and other contaminants that could negatively affect adhesion.
3. The gypsum roof board should be at least 1/2” thick. Refer to local building code for further coverboard and insulation requirements.
4. In most cases, no primer is required for this substrate. (Note: Using a compatible pre-primed gypsum board can prevent additional coating from being soaked into the board, and it is preferred.)
5. All seams must be treated with flashing grade and fabric.
6. Apply HydroStop® PremiumCoat® Foundation Coat and Finish Coat per the chart below.

| SEAMS & DETAILS HYDROSTOP® PREMIUMCOAT® SYSTEM | | | |
|--|------------------------------------|----------------|-------------|
| Treatment Type | Product | Total (Gal/Sq) | DFT* (mils) |
| 3-Coursed Rates | HydroStop® Butter Grade and Fabric | 4.0 | 43 |
| Flashing Grade Only Rates | HydroStop® Butter Grade | 2.0 | 19 |

| GYPNUM (DENSDECK® & SECUROCK®) HYDROSTOP® PREMIUMCOAT® SYSTEM | | | | | | | | | | | |
|--|-------------------------------|-------------|-------------------|-------------------|-------------------|----------------|-------------|----------------|-------------|-----------------|-----------------|
| | Foundation Coat (with fabric) | | Finish Coat | | | | | System | | Warranty | |
| | Total (Gal/Sq) | DFT* (mils) | 1st Coat (Gal/Sq) | 2nd Coat (Gal/Sq) | 3rd Coat (Gal/Sq) | Total (Gal/Sq) | DFT* (mils) | Total (Gal/Sq) | DFT* (mils) | Emerald Pledge™ | Diamond Pledge™ |
| 10 Year | 2.5 | 27 | 0.75 | 0.75 | | 1.50 | 13 | 4.00 | 40 | Yes | Yes |
| 15 Year | 2.5 | 27 | 1.00 | 1.00 | | 2.00 | 17 | 4.50 | 44 | Yes | Yes |
| 20 Year | 2.5 | 27 | 1.00 | 1.00 | 1.00 | 3.00 | 25 | 5.50 | 52 | Yes | Yes |

* Dry Film Thickness (DFT) is rounded to nearest mil, and is theoretical. Actual DFT will vary dependent on substrate profile, application technique and waste factor.

Note: DFT for 3-coursed rates includes 6 mils for the fabric.

QUICK SPEC

WARRANTY EXTENSION/RENEWAL – HYDROSTOP® PREMIUMCOAT® (HS-11)

NOTE: The following “Quick Spec” is an abbreviated specification and is not meant to replace the detailed specification. Read the entire 3-Part CSI System Specification prior to starting the project. Specifications are available at www.gaf.com.

Method

- Spray, roller, or brush apply HydroStop® PremiumCoat® Finish Coat

Requirements

- The existing HydroStop® Roofing System will be inspected to determine eligibility for recoat.
- Roof must be clean, dry, and tight.
- Adhesion test required to ensure proper adhesion to substrate(s).
- Apply at 50°F (10°C) and rising with no rain, dew, fog or freezing temperatures in forecast for 24 hours.
- GAF recommends that the surface temperature be at or less than 110°F (43°C) during application.

Application Instructions

1. Before applying HydroStop® PremiumCoat®, an adhesion test is required to ensure an adhesion minimum of 2.0 pounds per linear inch (PLI). Test patches to be applied with rates listed below.
2. Roof must be inspected before work begins. Any issues found during the inspection must be repaired prior to the application of additional HydroStop® PremiumCoat® Finish Coat.
3. Power wash roof to ensure it is free of dirt, debris, oil, and other contaminants that could negatively affect adhesion. United Cleaning Concentrate (UCC) is recommended to clean the roof. Allow to completely dry.
4. Apply HydroStop® PremiumCoat® System per the chart below.

| SEAMS & DETAILS HYDROSTOP® PREMIUMCOAT® SYSTEM | | | |
|--|------------------------------------|----------------|-------------|
| Treatment Type | Product | Total (Gal/Sq) | DFT* (mils) |
| 3-Coursed Rates | HydroStop® Butter Grade and Fabric | 4.0 | 43 |
| Flashing Grade Only Rates | HydroStop® Butter Grade | 2.0 | 19 |

| WARRANTY EXTENSION/RENEWAL HYDROSTOP® PREMIUMCOAT® SYSTEM | | | | | | |
|--|-------------------|-------------------|----------------|-------------|-----------------|-----------------|
| | Finish Coat | | | | Warranty | |
| | 1st Coat (Gal/Sq) | 2nd Coat (Gal/Sq) | Total (Gal/Sq) | DFT* (mils) | Emerald Pledge™ | Diamond Pledge™ |
| 10 Year | 0.75 | 0.75 | 1.50 | 13 | Yes | Yes |
| 15 Year | 1.00 | 1.00 | 2.00 | 17 | Yes | Yes |

* Dry Film Thickness (DFT) is rounded to nearest mil, and is theoretical. Actual DFT will vary dependent on substrate profile, application technique and waste factor.

Note: DFT for 3-coursed rates includes 6 mils for the fabric.

QUICK SPEC

METAL – HYDROSTOP® PREMIUMCOAT® + KYMAX (HS-12)

NOTE: The following “Quick Spec” is an abbreviated specification and is not meant to replace the detailed specification. Read the entire 3-Part CSI System Specification prior to starting the project. Specifications are available at www.gaf.com.

Method

- Use GAF Roof Brush to apply HydroStop® PremiumCoat® Foundation Coat
- Spray, roller, or brush apply HydroStop® PremiumCoat® Finish Coat

Requirements

- Roof must be clean, dry, and tight.
- Adhesion test required to ensure proper adhesion to substrate(s).
- Apply at 50°F (10°C) and rising with no rain, dew, fog or freezing temperatures in forecast for 24 hours.
- GAF recommends that the surface temperature be at or less than 110°F (43°C) during application.

Application Instructions

1. Before applying HydroStop® PremiumCoat®, an adhesion test is required to ensure an adhesion minimum of 2.0 pounds per linear inch (PLI). Test patches to be applied with rates listed below.
2. Tighten and/or replace existing fasteners.
3. Power wash roof to ensure it is free of dirt, debris, oil, and other contaminants that could negatively affect adhesion. United Cleaning Concentrate (UCC) is recommended to clean the roof. Allow roof to completely dry.
4. Install crickets to divert water and complete other necessary sheet metal repairs.
5. Prime rusty areas with Acrylex 400 Primer or StableRust Rust-Inhibiting Primer. For severe rust, prime area with Lock-Down Primer.
6. Horizontal seams must be 3-coursed with flashing grade and fabric. Overlap and trapezoidal vertical seams must be treated with flashing grade only. Other vertical seams may forgo treatment **IF** the seal/tape is intact on the seam or if they are double locked.
7. Treat all roof penetrations, skylight curbs & rake edges with HydroStop® PremiumCoat® Butter Grade Flashing with fabric.
8. Encapsulate fasteners with HydroStop® HydroCap Fastener Caps or HydroStop® PremiumCoat® Butter Grade Flashing.
9. Apply HydroStop® PremiumCoat® Foundation Coat and Finish Coat and Kymax per the chart below.

| SEAMS & DETAILS HYDROSTOP® PREMIUMCOAT® SYSTEM | | | |
|--|------------------------------------|----------------|-------------|
| Treatment Type | Product | Total (Gal/Sq) | DFT* (mils) |
| 3-Coursed Rates | HydroStop® Butter Grade and Fabric | 4.0 | 43 |
| Flashing Grade Only Rates | HydroStop® Butter Grade | 2.0 | 19 |

| METAL HYDROSTOP® PREMIUMCOAT® SYSTEM + KYMAX | | | | | | | | | | | | | | | |
|---|---------------------------|----------------|-------------|-------------------|-------------------|----------------|-------------|-------------------|-------------------|----------------|-------------|----------------|-------------|-----------------|-----------------|
| | Foundation Coat | | | Finish Coat | | | | Kymax | | | | System | | Warranty | |
| | Area | Total (Gal/Sq) | DFT* (mils) | 1st Coat (Gal/Sq) | 2nd Coat (Gal/Sq) | Total (Gal/Sq) | DFT* (mils) | 1st Coat (Gal/Sq) | 2nd Coat (Gal/Sq) | Total (Gal/Sq) | DFT* (mils) | Total (Gal/Sq) | DFT* (mils) | Emerald Pledge™ | Diamond Pledge™ |
| 20 Year | Field of Roof (no fabric) | N/A | 0 | 0.75 | 0.75 | 1.50 | 13 | 0.40 | 0.40 | 0.80 | 4.5 | 4.80 | 17.5 | Yes | Yes |

* Dry Film Thickness (DFT) is rounded to nearest mil, and is theoretical. Actual DFT will vary dependent on substrate profile, application technique and waste factor.

Note: DFT for 3-coursed rates includes 6 mils for the fabric.

QUICK SPEC

NON-METAL – HYDROSTOP® PREMIUMCOAT® + KYMAX (HS-13)

TPO, PVC, HYPALON, EPDM, ASPHALTIC, STRUCTURAL CONCRETE,
STRUCTURAL CORRUGATED TRANSITE PANELS. ISO, GYPSUM (DENSDECK®, SECUROCK®)

NOTE: The following “Quick Spec” is an abbreviated specification and is not meant to replace the detailed specification. Read the entire 3-Part CSI System Specification prior to starting the project. Specifications are available at www.gaf.com.

Method

- Use GAF Roof Brush to apply HydroStop® PremiumCoat® Foundation Coat
- Spray, roller, or brush apply HydroStop® PremiumCoat® Finish Coat

Requirements

- Roof must be clean, dry, and tight.
- Adhesion test required to ensure proper adhesion to substrate(s).
- Apply at 50°F (10°C) and rising with no rain, dew, fog or freezing temperatures in forecast for 24 hours.
- GAF recommends that the surface temperature be at or less than 110°F (43°C) during application.

Application Instructions

1. Before applying HydroStop® PremiumCoat®, an adhesion test is required to ensure an adhesion minimum of 2.0 pounds per linear inch (PLI). Test patches to be applied with rates listed below.
2. Conduct moisture survey and remove/replace all wet areas.
3. Power wash roof to ensure it is free of dirt, debris, oil, and other contaminants that could negatively affect adhesion. United Cleaning Concentrate (UCC) is recommended to clean the roof. Allow roof to completely dry.
4. Prime as needed. Please refer to the Cleaner & Primer Guide on p. 7 of the HydroStop® PremiumCoat® Liquid-Applied Roofing Manual.
5. Refer to the Seam Treatment Guide on p. 6 of the HydroStop® PremiumCoat® Liquid-Applied Roofing Manual for complete seam treatment guidelines.
6. Treat all roof penetrations, drains, curbs, and scuppers.
7. Apply HydroStop® PremiumCoat® Foundation Coat and Finish Coat and Kymax per the chart below.

| SEAMS & DETAILS HYDROSTOP® PREMIUMCOAT® SYSTEM | | | |
|--|------------------------------------|----------------|-------------|
| Treatment Type | Product | Total (Gal/Sq) | DFT* (mils) |
| 3-Coursed Rates | HydroStop® Butter Grade and Fabric | 4.0 | 43 |
| Flashing Grade Only Rates | HydroStop® Butter Grade | 2.0 | 19 |

| NON-METAL HYDROSTOP® PREMIUMCOAT® SYSTEM + KYMAX | | | | | | | | | | | | | | |
|---|-------------------------------|-------------|-------------------|-------------------|----------------|-------------|-------------------|-------------------|----------------|-------------|----------------|-------------|-----------------|-----------------|
| | Foundation Coat (with fabric) | | Finish Coat | | | | Kymax | | | | System | | Warranty | |
| | Total (Gal/Sq) | DFT* (mils) | 1st Coat (Gal/Sq) | 2nd Coat (Gal/Sq) | Total (Gal/Sq) | DFT* (mils) | 1st Coat (Gal/Sq) | 2nd Coat (Gal/Sq) | Total (Gal/Sq) | DFT* (mils) | Total (Gal/Sq) | DFT* (mils) | Emerald Pledge™ | Diamond Pledge™ |
| 20 Year | 2.5 | 27 | 0.75 | 0.75 | 1.50 | 13 | 0.40 | 0.40 | 0.80 | 4.5 | 4.80 | 44.5 | Yes | Yes |

* Dry Film Thickness (DFT) is rounded to nearest mil, and is theoretical. Actual DFT will vary dependent on substrate profile, application technique and waste factor.

Note: DFT for 3-coursed rates includes 6 mils for the fabric.

Section 4

Care & Preventative Maintenance

OVERVIEW

Due to its constant exposure to heat, cold, ultraviolet radiation, rain, snow, hail, high winds and/or mechanical damage, a roof can be the most vulnerable component of a building's exterior. Despite these negative effects, long-term performance can be enhanced, and major roof problems avoided, through correct design, quality materials, proper installation procedures and workmanship, and a comprehensive roof maintenance program. The cost of a comprehensive maintenance program is minimal compared to the cost of repairing and/or removing and replacing a damaged roofing system.

The roofing system is a critical asset in the overall building envelope, and should be treated as such. Identifying and correcting potential problems early is paramount to ensuring that small problems do not become major issues. It is also essential in maintaining the integrity of the roof, protecting the building's contents, and avoiding interruption of the building's intended function. A thorough and consistent maintenance schedule will not only extend the life of the roofing system and lower life cycle and replacement costs, but will help protect other building components as well.

UNDERSTANDING THE IMPORTANCE OF PROPER ROOF MAINTENANCE AND REPAIR

Like all roofing systems, roofs that have been coated require regular maintenance and repair to enhance long-term service life. The Roof Coatings Manufacturers Association (RCMA) recommends that roofs and coatings be inspected twice each year, generally in the spring and fall, and after any major storms or high speed wind events. Additional coating should be applied as necessary to repair damage to the coating or underlying roofing substrate. Additional coating can also be applied where the existing coating has worn away. Refer to the specific sections of this Manual for more information on coating and re-coating applications.

GENERAL CARE & PREVENTATIVE MAINTENANCE

The following is a list of general care and maintenance recommendations that will help achieve maximum performance from the roofing system.

- Provide proper drainage...to minimize standing water on the roof. Keep the roof surface clean from leaves, pine needles, twigs, paper, accumulated dirt and other debris, which tends to accumulate at and clog drains. Cut back trees or branches growing too close to the roof. Ponding of water on the surface of the roofing system will increase the probability of moisture entering the structure in the event of a puncture or other mechanical damage to the roofing membrane.
- Check the building exterior...for settlement or movement. Cracks in the walls are a warning of possible cracks in the roof substrate and flashing. Ensure that overhangs, cornices, fasciae, and edging are in good condition.
- Avoid damaging the roofing system by exposing it to any of the following, which could cause premature degradation of the coating or membrane:
 - Liquids containing petroleum products
 - Solvents
 - Grease used for lubricating rooftop units or from restaurant vents
 - Oils (new or old) used for air conditioning or compressor units
 - Kitchen waste or other animal fats
 - Chemicals

- The use of catch pans (including proper drainage of these pans or other means of protection) may be used to protect the roofing membrane from exposure to grease, chemicals, and other materials that would otherwise be expelled onto the roof surface. Prolonged exposure to these materials can cause swelling and possible degradation of the roofing system if spills are not removed in a timely manner.
- Check for signs of algae, mold, mildew or other plant growth on the roof, particularly in shaded areas that hold water.
- Unprotected areas of the roofing system are more susceptible to damage from heavy foot traffic and additional measures must be taken to avoid damage to the system. Contact GAF at 1-800-ROOF-411 (1-800-766-3411) for recommendations where heavy foot traffic is expected.
- If snow removal is necessary, use plastic shovels and be careful when working around protrusions or other areas where detail work could be damaged. Snow blowers, picks, axes and shovels with sharp edges must not be used on the roof.
- Remove foreign debris, such as glass, bolts, nails, screws, metal shavings, and any other materials that may cause punctures or cuts to the liquid-applied coating or roofing system.
- Limit roof access. Most roof damage is caused by individuals that are not authorized to access the roof, or by individuals that are not aware of the damage that can be caused when proper precautionary procedures are not followed. Roof access should be strictly limited to authorized personnel and outside personnel should be informed as to the precautions necessary when accessing the roof. Make a log of all visitors and maintenance personnel accessing the roof.
- Make sure that maintenance personnel are warned against dropping tools and equipment on the coated roof surface in order to avoid puncturing the membrane. When servicing the rooftop HVAC units, antennas, solar panels, satellite dishes, etc., care should be taken when placing tools, metal doors, lids, pans, or sharp objects on the coating system surface. When moving roof-mounted units or equipment over coated roofs, avoid damage by placing smooth plywood over the coating membrane prior to moving any equipment.
- Repair of any damage caused by misuse of the roofing system is the responsibility of the Building Owner. The Building Owner is also responsible for ensuring that any such damage is properly repaired by either the original contractor of record or another GAF-certified contractor. If timely repairs are not made to rectify mechanical damage or other misuse of the roofing system, this can result in the need for major repairs or replacement of the roof or roof coating system at the building owner's sole expense.

SEMI-ANNUAL INSPECTIONS & MAINTENANCE

When conducting a semi-annual inspection, the liquid-applied roofing system or coating may be slippery when wet. Exercise caution when walking on the liquid-applied roof system or coating during or after a rain shower, or if moisture is present in the form of dew, frost or ice. Pay attention while walking on light-colored surfaces as ice or frost build-up may not be as visible as on a dark surface.

Semi-Annual Inspection & Maintenance

Consist of cleaning the membrane and then a visual examination of the roof coating system. The inspection should include the overall coating condition as well as the integrity of flashings, vent pipes and other protrusions, skylights, drains, gutters, parapet walls and caps, adjacent walls, and mechanical equipment. Also check for evidence of any biological growth or other foreign debris.

Preventative Maintenance Program

Consists of regularly scheduled inspections and subsequent corrective actions, intended to maximize the life expectancy of the roofing system. It is recommended that preventative maintenance semi-annual inspections be scheduled in the spring and fall.

Additional Inspections

In addition to the scheduled semi-annual inspection, additional inspections should be scheduled if the roof is exposed to abusive or unusual conditions including but not limited to those listed below. Maintenance programs that include semi-annual inspections can usually be arranged through the installing contractor or another GAF-certified contractor. They can also be performed by a registered roof consultant or other qualified personnel who have been properly trained in liquid-applied roofing systems and safety. These inspections should be attended by the Building Owner and/or in-house maintenance personnel responsible for the roof. Additional roof inspections should be conducted whenever any of the following conditions occur:

1. Exposure of the roof to severe weather, such as strong winds, hail or continuous heavy rainfall.
 - Examine the roof for severely ponded areas, accumulated debris, and any damage to building components that may allow moisture to infiltrate the roofing membrane. The coating or liquid-applied system should also be examined in areas where severe conditions may have caused punctures, tears, abrasions or loose coating.
2. After repair or replacement of rooftop equipment, or at any other time when the roof may be exposed to activities from other trades where damage may occur.
 - Examine the roof for spills, debris, sharp objects, punctures, excessive wear, or other damage caused by heavy traffic or modifications to the roof.

Cleaning Procedures

WARNING: The liquid-applied roofing system or coating may be slippery when wet. Exercise caution when walking on the liquid-applied roof system during cleaning.

1. Remove any build-up of rocks, branches, leaves, pine needles and other foreign debris, as well as excessive dirt build-up around drains and other low areas. Use a plastic rake, medium-bristle push brush or other appropriate method for removing accumulated debris from the roof, using the least amount of pressure possible. Remove any excessive build-up or blockage from drains, gutters and downspouts. Ensure that downspouts on multi-level roofs do not dump directly onto the coated roof surface below. Trim any overhanging trees to

prevent excessive leaf and pine needle accumulation, allowing as much sunlight to the roof as possible to help eliminate mildew and algae growth.

2. Liberally apply GAF United Cleaning Concentrate, diluted at a ratio of 1 part concentrate to 10 parts water, under low pressure to a given section of the roof at the rate of 0.4 to 0.7 gallons per 100 ft² (1.6 to 2.9 L/m²). Allow the cleaner to sit for a minimum of 15 minutes.
3. Make sure that areas where algae, mold, or mildew growth has occurred are thoroughly saturated. These areas should also receive additional scrubbing with a medium to stiff bristle brush to assure the most complete removal possible.
4. Pressure rinse toward the drains using clean water and a 1,200 to 1,500 psi pressure washer. Use a fan tip on the extension wand, held no closer than 12" (305 mm) from the coated roof surface. Low areas where the dirt has accumulated may require additional agitation using a broom or cleaning pad.

IMPORTANT: Roof wash-off catchment systems should be in place when required. Be sure to follow state and local requirements for roof-wash off catchments during the cleaning process.

INSPECTION CHECKLIST

Pre-Inspection

1. Prior to the actual roof inspection, a detailed roof plan should be prepared, on which any defects and notes can be recorded.
2. Prior to going onto the roof itself, inspect the underside of the deck (if accessible), as well as the outside of the building. Note any signs of excessive moisture or deterioration. These observations can give clues to not only problems with the roof, but also other conditions affecting the performance of the building envelope.

| GAF Inspection Checklist | | |
|--------------------------------------|--|---|
| Area of Concern | Treatment | ✓ |
| Roof Membrane & Flashings | <ul style="list-style-type: none"> • Ensure that the overall roof coating membrane is sound and free of mechanical damage, splits, crazing, and cracking. In areas prone to standing water, inspect the coating surface for signs of blisters, delamination, or degradation caused by biological growth. | |
| Roof Drains & Scuppers | <ul style="list-style-type: none"> • Ensure that roof drains and scuppers are clear and free of all debris to allow for proper drainage. Check drain covers to verify that they are tight and properly fastened. Ensure that the coating around drains and scuppers is sound and free of blisters, tears, and delaminations. | |
| Parapet Walls & Caps | <ul style="list-style-type: none"> • Inspect interface between roof deck and parapet walls to ensure that there are no splits or tears, and that the coating membrane is fully-adhered and sound. Examine parapet walls and caps to ensure that there are no cracks or breaks in the substrate or membrane that will allow moisture to enter beneath the coating system. | |
| Protrusions | <ul style="list-style-type: none"> • Inspect the reinforced coating around all protrusions, such as vent pipes, for any signs of splits, tears or delaminations around the base. Ensure that vent pipes have the proper caps installed. Inspect coating to ensure that it is still self-flashing and secure around the top of all protrusions. | |
| Roof Mounted Equipment | <ul style="list-style-type: none"> • All rooftop equipment should be inspected to ensure that it is well-secured to the base risers, and that the coating and reinforcement around the base is sound and free of blisters, tears and delaminations. | |
| Skylights | <ul style="list-style-type: none"> • Check the reinforcement around all skylights to ensure that it is sound and free of blisters, tears and delaminations. | |
| Other Details | <ul style="list-style-type: none"> • Check the bricks and mortar on chimneys, as well as caulking or joints in metal flashings such as copings, counter-flashings, rooftop units, curbs, caps, expansion joints, etc. Repair or replace caulking as necessary. | |
| Moisture Analysis (optional) | <ul style="list-style-type: none"> • If damage has caused concern with moisture penetration into the roof substrate, a non-destructive moisture detection survey can be conducted to provide an accurate analysis. Two common methods are nuclear metering and infrared thermography. A moisture meter probe can also be inserted through the coating; however, this is a destructive method and will require the damage be repaired. | |
| Minor Repairs | <ul style="list-style-type: none"> • Areas found to need minor repairs (e.g., small punctures and tears) during the inspection may be repaired with Roof Mate Butter Grade. More extensive repairs may be treated with Roof Mate Butter Grade product with fabric. For project-specific recommendations, please contact GAF's Technical Services. | |

ROOF SPECIFIC LEAK INVESTIGATION

On metal decks, it is important to identify the direction of the deck flutes and deck slope. Moisture may infiltrate through the roofing system, migrate in the lower flutes of the deck, and leak inside the building in low areas.

On concrete decks or on projects where the existing roofing material is left in place, leaks may result from moisture entrapment in the original installation.

On poorly insulated roofing assemblies, leaks may occur as the result of condensation. It is therefore important to determine the leak location and frequency. Sources of air leakage should be sealed if possible.

1. Begin leak investigations by conducting a thorough visual inspection of the general location on the roof where leaks have been detected inside the building.
2. Inspect detail areas such as drains, vents, scuppers, HVAC and other roof-mounted equipment, parapets, ponded water areas, etc. If the roof is dry at the time of investigation, areas where water ponds can be identified by evidence of accumulated residue on roof membrane.
3. Examine lower areas of the roof for moisture beneath the roof coating system (soft insulation can be detected when walking over the roof).
4. Check areas around mechanical rooftop equipment, drains, skylights, roof hatches, expansion joints, pipes, vents, etc. to identify cuts or punctures in the coating membrane.
5. Examine the condition of metal flashings (i.e., edging, coping, expansion joint covers, parapet caps, etc.) for cracks and improperly sealed joints.
6. When a visible source of the leak has not been identified, wet the system at the anticipated leak area with water and examine the interior area for leaks.
7. Often, an inspection of the underside of the deck will reveal signs of water leakage and/or air infiltration.

EMERGENCY REPAIRS

GAF must be notified of any leaks within 30 days of discovery of a leak or GAF will have no responsibility for making repairs or replacing that portion of the products that leak as a result of a manufacturing defect. The Building Owner may make temporary repairs to minimize damage to the building or its contents in an emergency. Only qualified workers should perform temporary repairs. These repairs will not result in cancellation of the applicable guarantee or warranty as long as they are reasonable and customary and do not result in permanent damage to the GAF roofing materials. When weather conditions permit, permanent repairs should be completed by a GAF-certified contractor at GAF's direction if it is a covered leak or at the building owner's direction for non-covered leaks.

Repairs should not be made with asphalt-based products unless a wet patch type product is needed for emergency purposes. If wet patch products are used they must be completely removed at the time permanent repairs are made.

Temporary Dry Surface Emergency Repairs

- Clean the coating surface around the damaged area using GAF United Cleaning Concentrate.
- Rinse the area with clean water and allow it to dry.
- Apply HydroStop® PremiumCoat® Butter Grade Flashing and embed with fabric as needed to provide additional strength. Contact GAF Technical Services before any other product is used to confirm its suitability.

Specific Repairs to Liquid-Applied Roofing Systems over Spray Polyurethane Foam (SPF) Insulation

- Minor breaks in the coating or mechanical damage to sprayed polyurethane foam (SPF) may be repaired with approved urethane caulk and then top-coated with HydroStop® PremiumCoat® Butter Grade Flashing with or without fabric. The damaged foam must be completely cut away prior to repairing. If the repaired area is larger than 2" (51 mm) in diameter, consult GAF Technical Services for proper repair procedures. **Note:** If silicone is used for repair, the area must be filled with Unisil with Unisil Fibers.
- Large blisters that are not leaking but have broken open should be removed and repaired. If the blister has not broken open, GAF recommends leaving it in place.

Specific Repairs to Liquid-Applied Roofing Systems Not Over Spray Polyurethane Foam (SPF) Insulation

- Repair minor mechanical damage to the liquid-applied coating membrane with HydroStop® PremiumCoat® Butter Grade Flashing and/or approved urethane caulk, and then top-coated with an approved GAF product. The damaged membrane must be completely cut away prior to repairing. If the repaired area is larger than 2" (51 mm) in diameter, consult GAF Technical Services for proper repair procedures.
- If the liquid-applied roofing system incorporates reinforcement fabric, then the repair should use HydroStop® PremiumCoat® Butter Grade Flashing with or without fabric.

ROOF ALTERATIONS

General

GAF must be notified of any planned roof alterations prior to such alterations being made. Coverage under the guarantee or warranty may be jeopardized if:

- GAF is not notified of alterations.
- The original contractor of record (or another GAF-certified contractor) does not do the required work.
- Non-GAF products are used.

All alterations must be pre-approved, including but not limited to modifications such as roof-top HVAC units or other equipment, pipes, satellite dishes, antennas, conduit, general penetrations, skylights, etc.

NOTE: These maintenance and inspection procedures are provided for guideline use only. Your GAF-certified contractor or professional roof consultant may provide a more detailed maintenance program. Maintain records of roof damage and maintenance inspections for each building roof.

Section 5

Architectural Detail Drawings

| HydroStop® PremiumCoat® Architectural Design Drawings | | |
|--|--|--------|
| Drawing Number | Substrate Specification | Page # |
| HS-101 | Typical Metal Roof Joint Detail | 50 |
| HS-102 | Section at Vertical Panel Seam | 51 |
| HS-104 | Deck Joint Stripping Detail | 52 |
| HS-201 | Standard Drip Edge Detail | 53 |
| HS-202 | Gutter With Standard Drip Edge Detail | 54 |
| HS-203 | Concrete Roof Deck Edge Detail | 55 |
| HS-300 | Alternate Wall Flashing Detail | 56 |
| HS-301 | Wall Flashing Detail | 57 |
| HS-302 | Drip Edge Parapet Wall Detail | 58 |
| HS-303 | Typical Roof Cant At Corner | 59 |
| HS-304 | Typical Equipment Curb Flashing Detail | 60 |
| HS-305 | Scupper Detail | 61 |
| HS-401 | Curb to Curb Expansion Joint Flashing Detail | 62 |
| HS-502 | Vent-Pipe Flashing Detail | 63 |
| HS-503 | Vent-Stack Flashing Detail | 64 |
| HS-504 | Standard Roof Drain Detail | 65 |
| HS-505 | Exhaust Fan (for Cooking) Flash Detail | 66 |

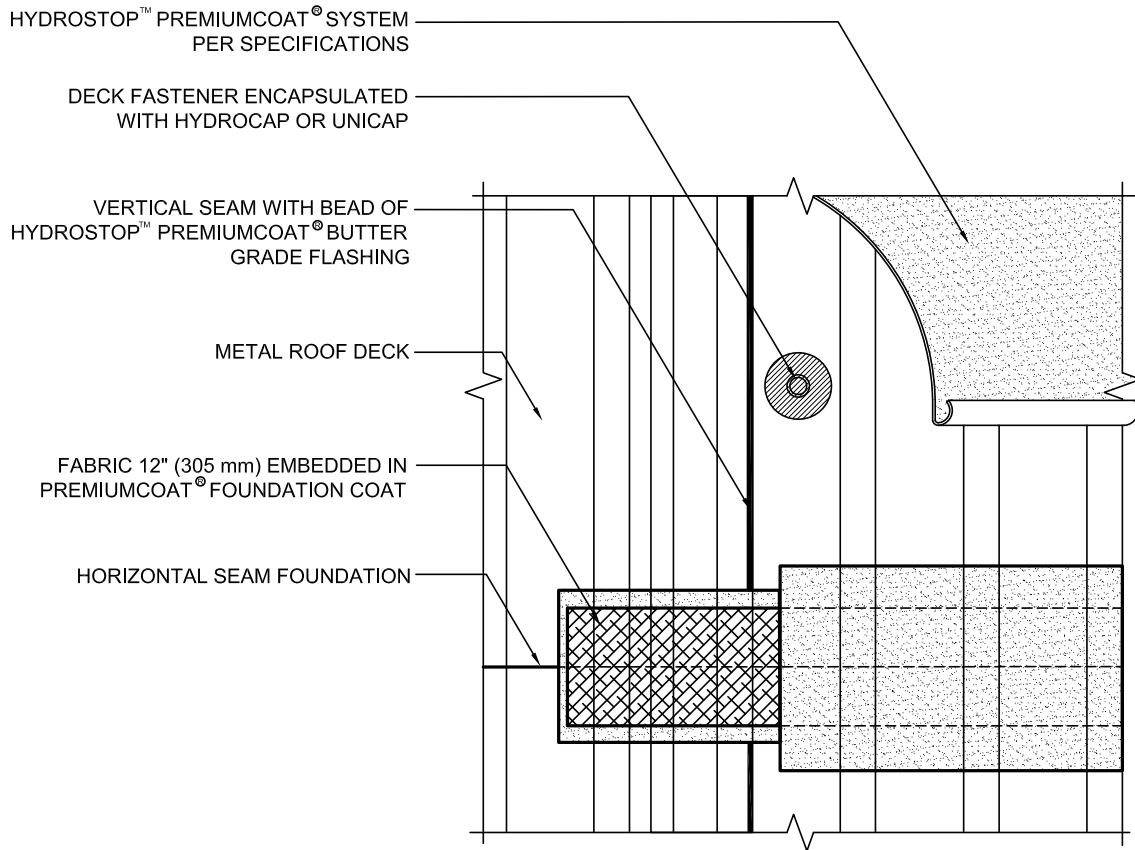

NOTE:

1. PREPARE ALL SURFACES AS REQUIRED BY GAF SPECIFICATIONS.
2. IF RUST IS PRESENT, PRIME ENTIRE ROOF WITH STABLE RUST PRIMER @ 1/2 GALLON / 100 SF MIN COVERAGE.
3. REMOVE LOOSE OR DAMAGED FASTENERS AND REPLACE WITH FASTENERS DESIGNED TO PENETRATE THE DECK AND SUPPORTING MEMBERS WITH NEOPRENE WASHERS AT THE SCREW HEAD.
4. DECK CONFIGURATIONS MAY DIFFER FROM THE DECK PROFILE INDICATED, BUT THE APPLICATION SHALL REMAIN THE SAME.
5. HYDROSTOP™ PREMIUMCOAT® SYSTEM- FOUNDATION COAT, FABRIC, FOUNDATION COAT, AND FINISH COAT COMPONENTS.
6. PRIMING - REFER TO HYDROSTOP® SPECIFICATIONS FOR DECK PRIMING REQUIREMENTS.

| | | | | |
|---|---|--|---------------------|----------------------------------|
|  <small>www.gaf.com 1 Campus Drive Parsippany, NJ 07054</small> | HYDROSTOP FIELD OF ROOF SERIES | METAL ROOF HORIZONTAL JOINT DETAIL | SYSTEM HS | DRAWING # 101 |
| | | | SCALE N.T.S. | ISSUE/ REVISION DATE 12-15-16 |

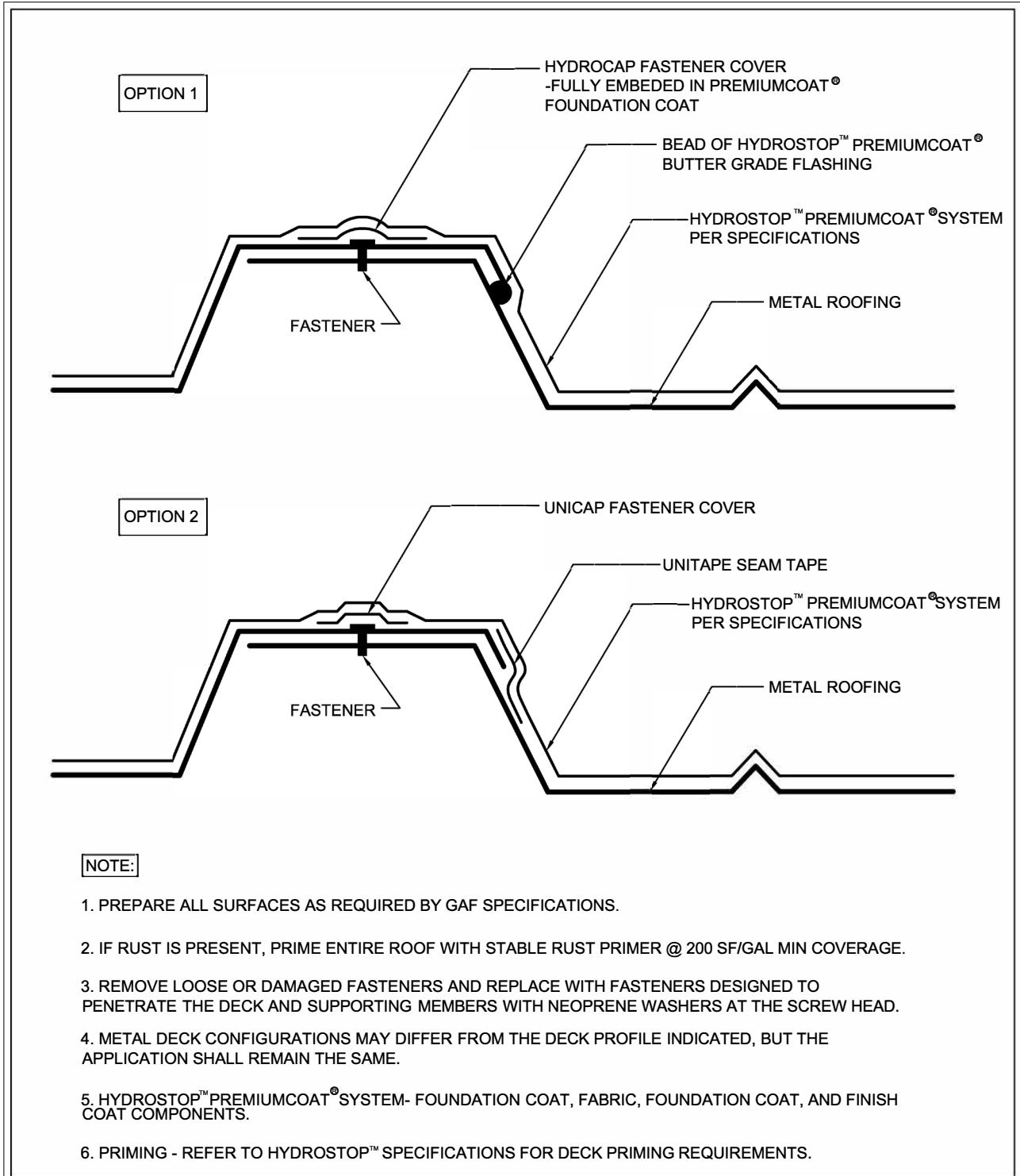

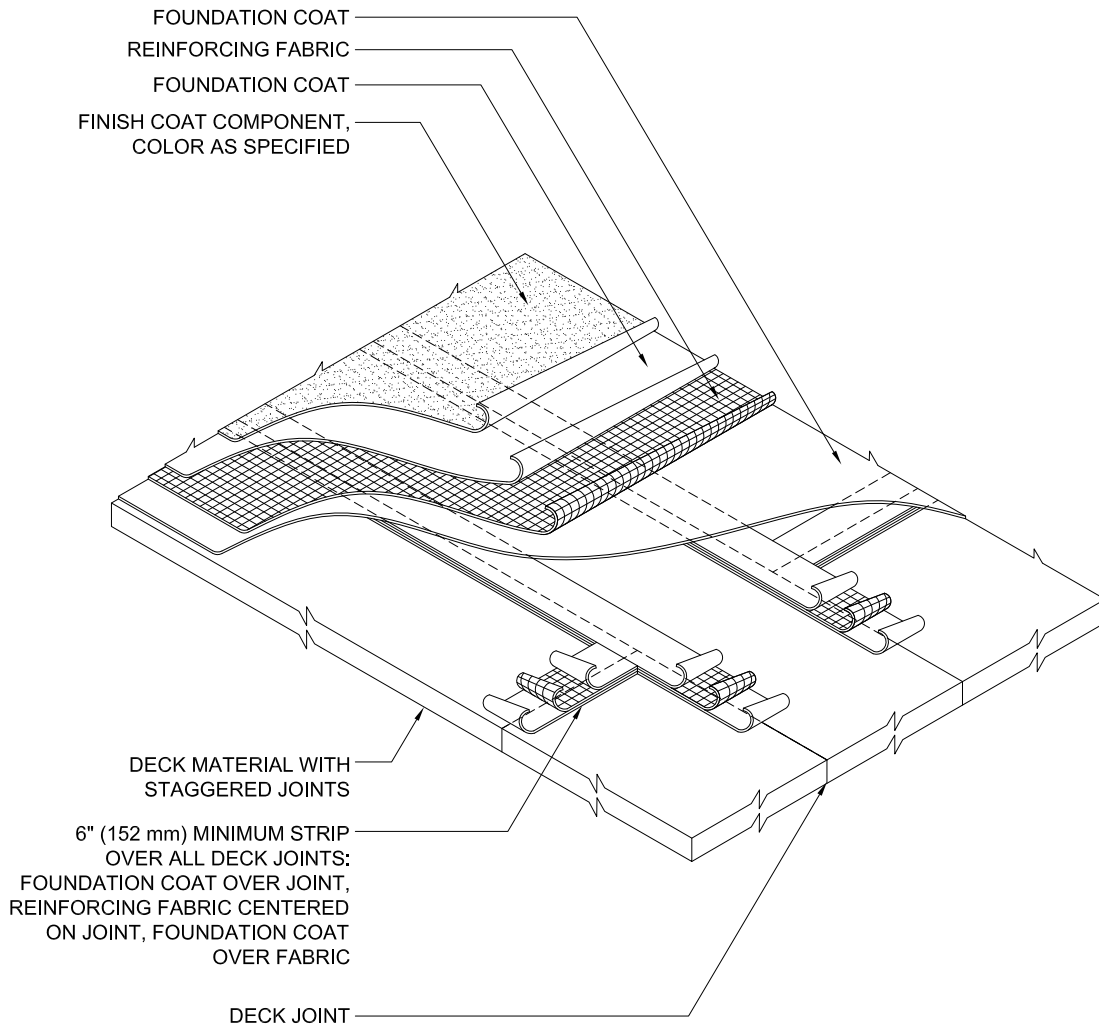

| | | | | |
|--|-------------------------|---------------------------------------|---------------------|---------------------------------|
|  <small>www.gaf.com</small> 1 Campus Drive Parsippany, NJ 07054 | HYDROSTOP | SECTION AT VERTICAL PANEL SEAM | SYSTEM HS | DRAWING # 102 |
| | FIELD OF ROOF SERIES | | SCALE N.T.S. | ISSUE/ REVISION DATE 11-1-16 |



NOTE:

1. PREPARE ALL SURFACES IN ACCORDANCE WITH GAF SPECIFICATIONS.
2. ALL JOINTS SHALL BE TIGHT AND STABLE. ALL FASTENERS SHALL BE FLUSH WITH THE DECK.
3. PREMIUM COAT® SYSTEM - FOUNDATION COAT, FABRIC, FOUNDATION COAT, AND FINISH COAT COMPONENTS.
4. PRIMING - REFER TO HYDROSTOP® SPECIFICATIONS FOR DECK PRIMING REQUIREMENTS.

| | | | | |
|---|---|------------------------------------|--|--|
|  <small>www.gaf.com 1 Campus Drive Parsippany, NJ 07054</small> |  | DECK JOINT STRIPPING DETAIL | <small>SYSTEM</small> HS | <small>DRAWING #</small> 104 |
| | <small>FIELD OF ROOF SERIES</small> | <small>SCALE</small> N.T.S. | <small>ISSUE/ REVISION DATE</small> 12-1-16 | |

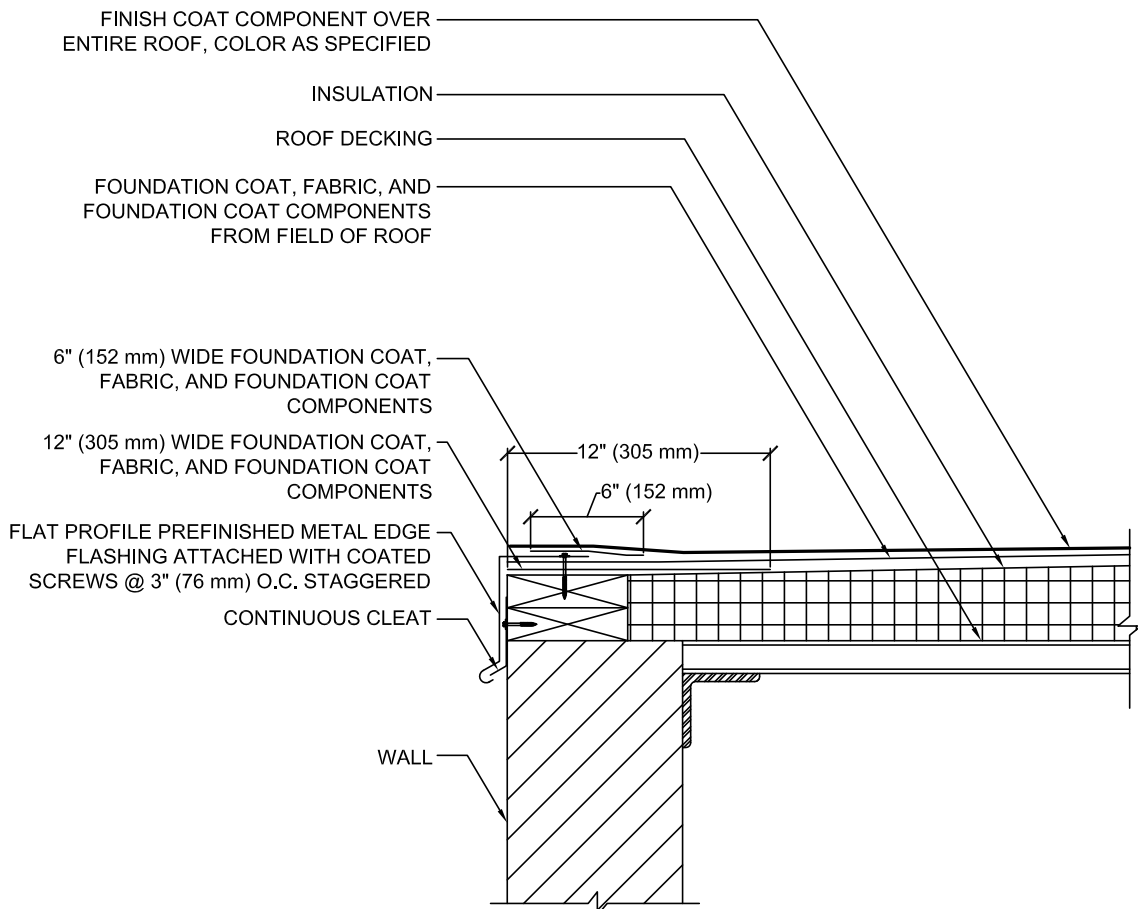

NOTE:

1. ALL FLASHING SHALL BE DESIGNED FOR THE APPLICABLE CONDITIONS. METAL THICKNESS, FASTENERS AND LAPPING SHALL BE AS SPECIFIED BY THE ROOF DESIGNER.
2. REFER TO THE SPECIFICATIONS FOR SPECIFIC EXECUTION REQUIREMENTS.
3. PREMIUM COAT® SYSTEM - FOUNDATION COAT, FABRIC, FOUNDATION COAT, AND FINISH COAT COMPONENTS.
4. PRIMING - REFER TO HYDROSTOP® SPECIFICATIONS FOR DECKING PRIMING REQUIREMENTS.

| | | | | |
|--|---------------------|----------------------------------|---------------------|----------------------------------|
|  <small>www.gaf.com</small> 1 Campus Drive Parsippany, NJ 07054 | HYDROSTOP | STANDARD DRIP EDGE DETAIL | SYSTEM HS | DRAWING # 201 |
| | ROOF EDGE SERIES | | SCALE N.T.S. | ISSUE/ REVISION DATE 12-15-16 |

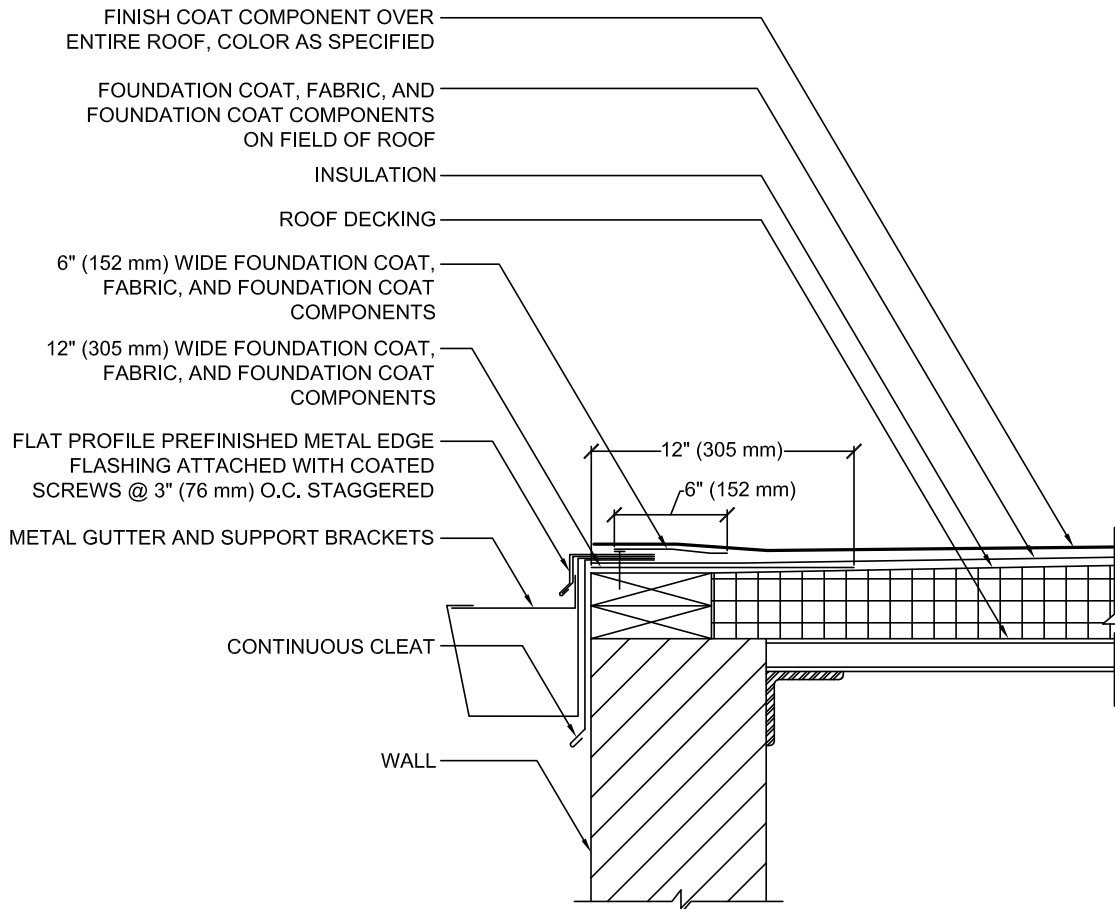

NOTE:

1. ALL FLASHING SHALL BE DESIGNED FOR THE APPLICABLE CONDITIONS. METAL THICKNESS, FASTENERS AND LAPPING SHALL BE AS SPECIFIED BY THE ROOF DESIGNER.
2. REFER TO THE SPECIFICATIONS FOR SPECIFIC EXECUTION REQUIREMENTS.
3. PREMIUM COAT® SYSTEM - FOUNDATION COAT, FABRIC, FOUNDATION COAT, AND FINISH COAT COMPONENTS.
4. PRIMING - REFER TO HYDROSTOP® SPECIFICATIONS FOR DECKING PRIMING REQUIREMENTS.

| | | | | |
|---|---|--|------------------------------------|---|
|  <small>www.gaf.com</small> <small>1 Campus Drive Parsippany, NJ 07054</small> |  | GUTTER WITH STANDARD DRIP EDGE DETAIL | <small>SYSTEM</small> HS | <small>DRAWING #</small> 202 |
| | <small>ROOF EDGE SERIES</small> | | <small>SCALE</small> N.T.S. | <small>ISSUE/ REVISION DATE</small> 12-15-16 |

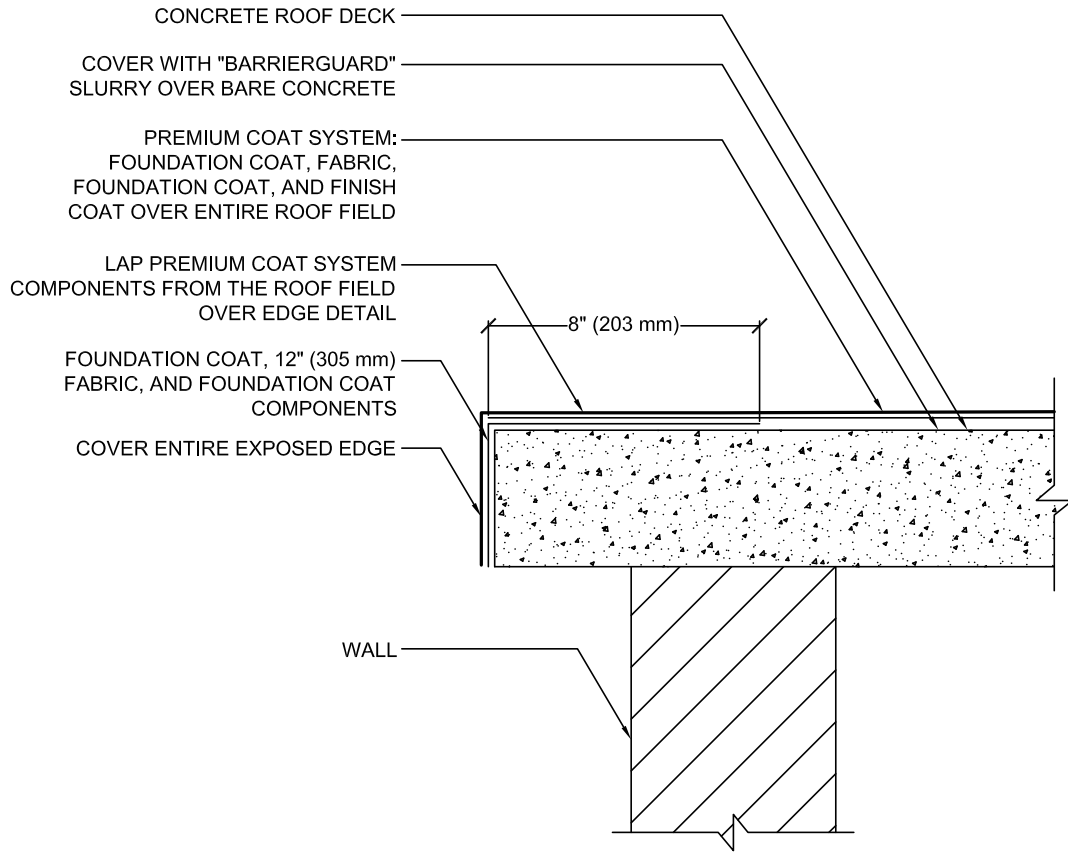



NOTE:

1. ALL FLASHING SHALL BE DESIGNED FOR THE APPLICABLE CONDITIONS. METAL THICKNESS, FASTENERS AND LAPPING SHALL BE AS SPECIFIED BY THE ROOF DESIGNER.
2. REFER TO THE SPECIFICATIONS FOR SPECIFIC EXECUTION REQUIREMENTS.
3. PREMIUM COAT® SYSTEM - FOUNDATION COAT, FABRIC, FOUNDATION COAT, AND FINISH COAT COMPONENTS.
4. PRIMING - REFER TO HYDROSTOP® SPECIFICATIONS FOR DECK PRIMING REQUIREMENTS.

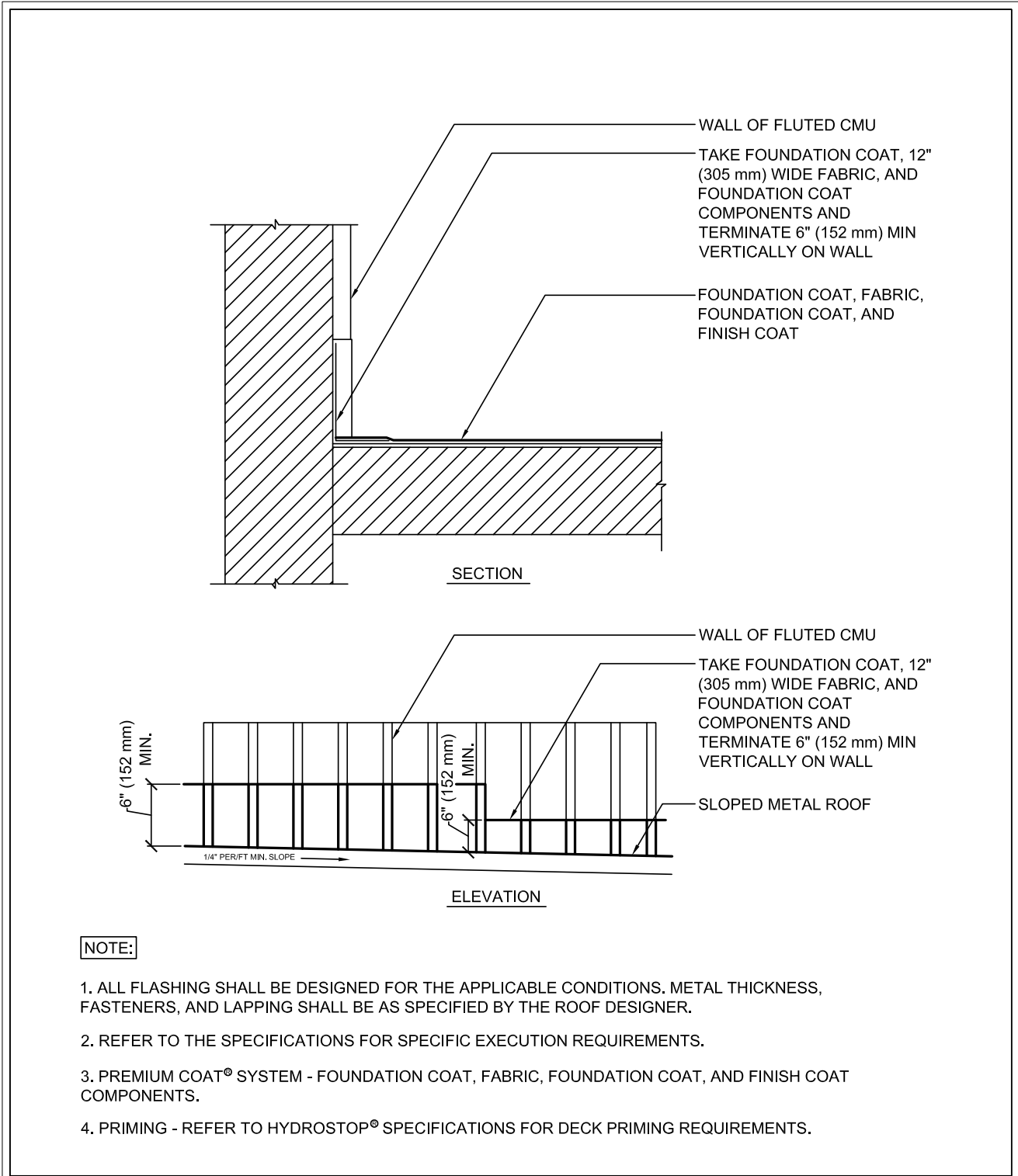
| | | | | |
|---|-------------------------------------|---|------------------------------------|---|
|  <small>www.gaf.com 1 Campus Drive Parsippany, NJ 07054</small> | HYDROSTOP | CONCRETE ROOF DECK EDGE DETAIL | <small>SYSTEM</small> HS | <small>DRAWING #</small> 203 |
| | <small>ROOF EDGE SERIES</small> | | <small>SCALE</small> N.T.S. | <small>ISSUE/ REVISION DATE</small> 12-15-16 |



| | | | | |
|---|--|---------------------------------------|---------------------|---------------------------------|
|  <small>www.gaf.com 1 Campus Drive Parsippany, NJ 07054</small> |  WALL & CURB SERIES | ALTERNATE WALL FLASHING DETAIL | SYSTEM HS | DRAWING # 300 |
| | | | SCALE N.T.S. | ISSUE/ REVISION DATE 12-1-16 |

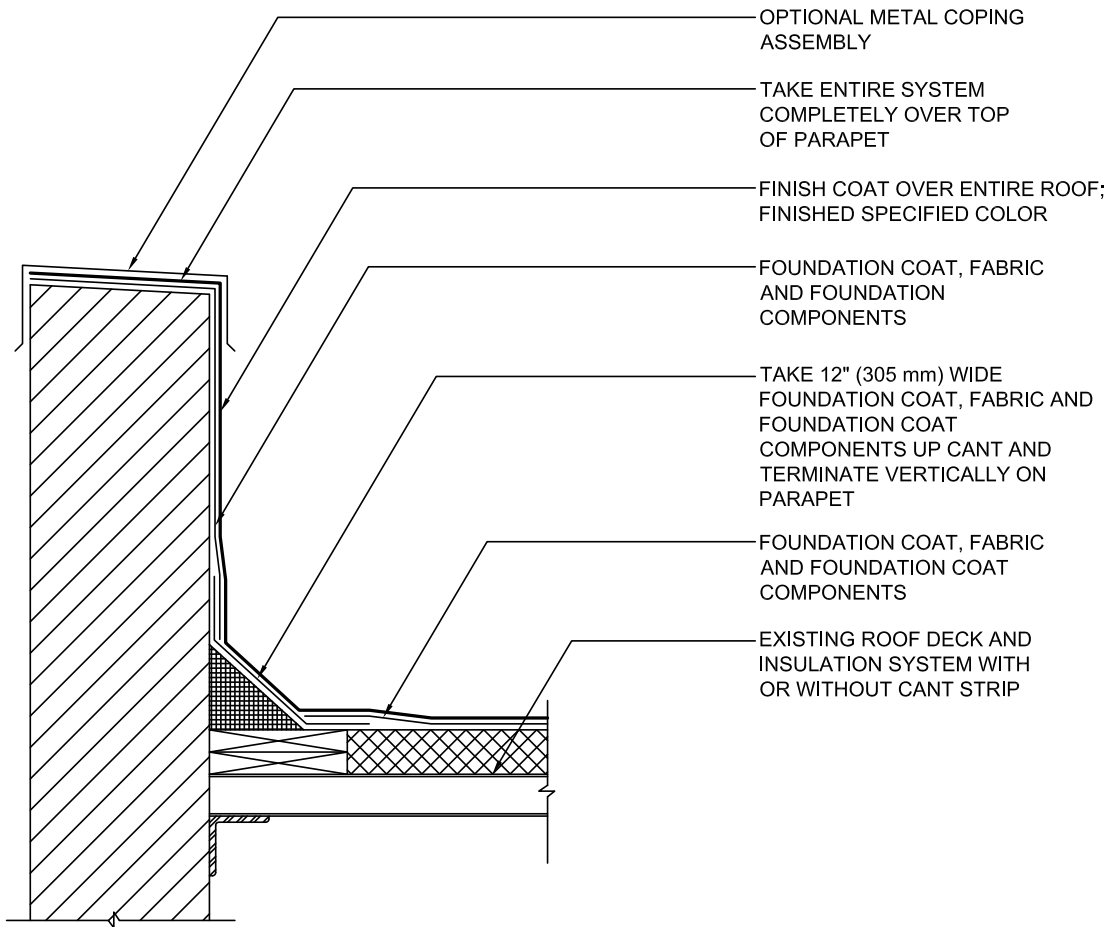

NOTE:

1. ALL FLASHING SHALL BE DESIGNED FOR THE APPLICABLE CONDITIONS. METAL THICKNESS, FASTENERS, AND LAPPING SHALL BE AS SPECIFIED BY THE ROOF DESIGNER.
2. REFER TO THE SPECIFICATIONS FOR SPECIFIC EXECUTION REQUIREMENTS.
3. PREMIUM COAT® SYSTEM - FOUNDATION COAT, FABRIC, FOUNDATION COAT, AND FINISH COAT COMPONENTS.
4. PRIMING - REFER TO HYDROSTOP® SPECIFICATIONS FOR DECK PRIMING REQUIREMENTS.

| | | | | |
|---|---|-----------------------------|------------------------------------|--|
|  <small>www.gaf.com 1 Campus Drive Parsippany, NJ 07054</small> | HYDROSTOP™ | WALL FLASHING DETAIL | <small>SYSTEM</small> HS | <small>DRAWING #</small> 301 |
| | <small>WALL & CURB SERIES</small> | | <small>SCALE</small> N.T.S. | <small>ISSUE/ REVISION DATE</small> 12-1-16 |

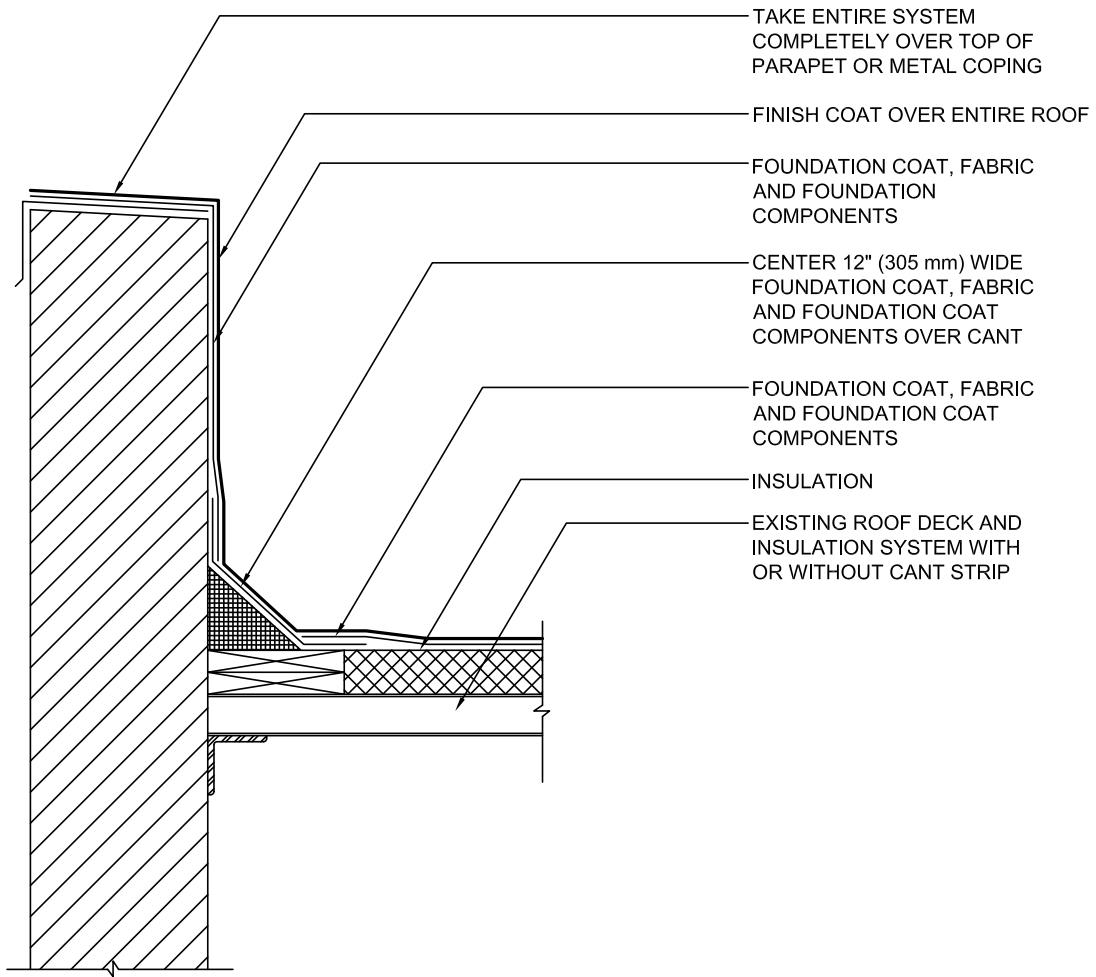

NOTE:

1. PREPARE ALL SURFACES IN ACCORDANCE WITH GAF SPECIFICATIONS.
2. PREMIUM COAT® SYSTEM - FOUNDATION COAT, FABRIC, FOUNDATION COAT, AND FINISH COAT COMPONENTS.
3. PRIMING - REFER TO HYDROSTOP® SPECIFICATIONS FOR DECK PRIMING REQUIREMENTS.

| | | | | |
|--|---|--------------------------------------|---------------------|---------------------------------|
|  <small>www.gaf.com</small> 1 Campus Drive Parsippany, NJ 07054 | HYDROSTOP WALL & CURB SERIES | DRIP EDGE PARAPET WALL DETAIL | SYSTEM HS | DRAWING # 302 |
| | | | SCALE N.T.S. | ISSUE/ REVISION DATE 12-1-16 |

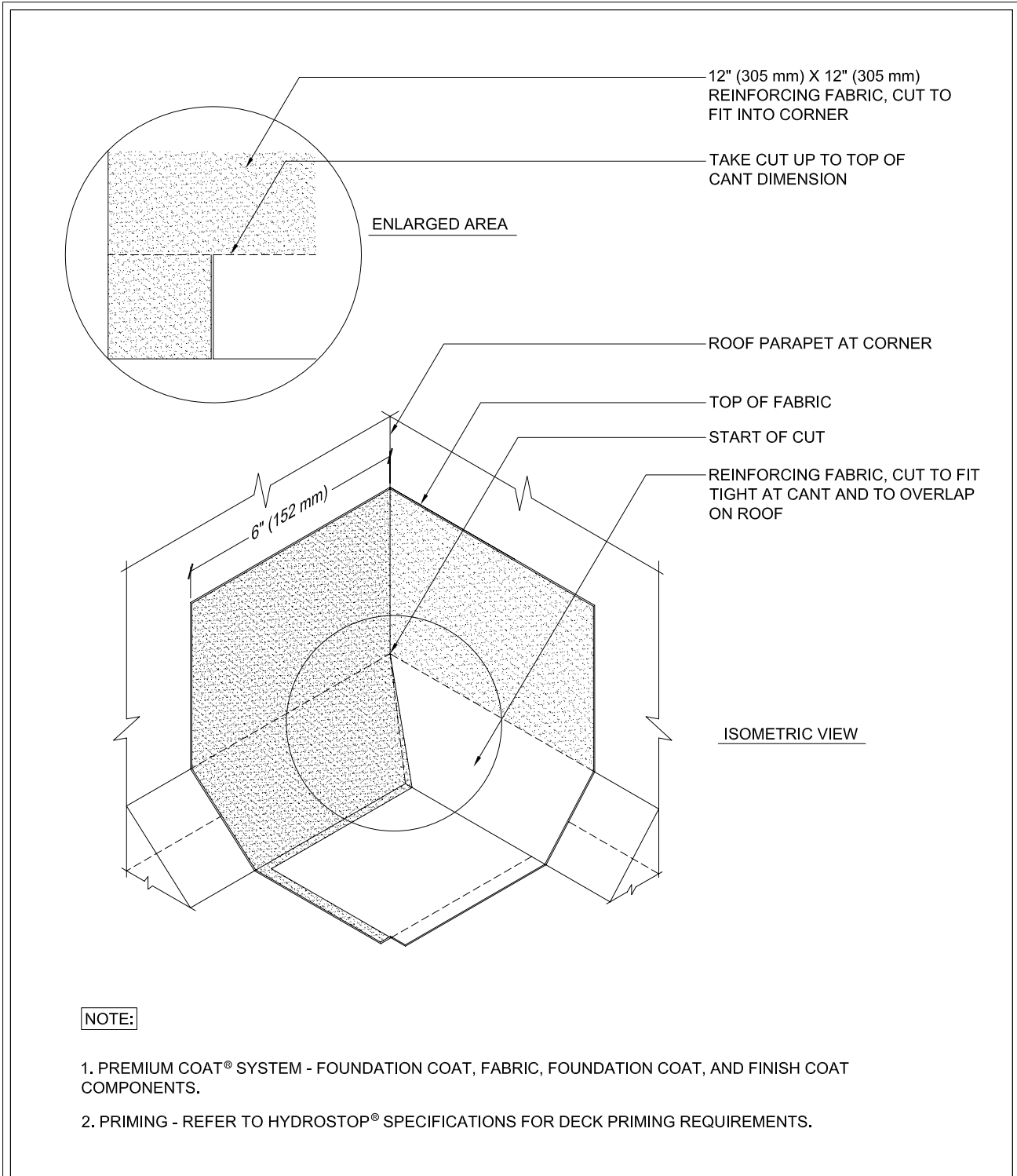

| | | | | |
|---|---|-----------------------------|---------------------|---------------------------------|
|  <small>www.gaf.com 1 Campus Drive Parsippany, NJ 07054</small> | HYDROSTOP WALL & CURB SERIES | TYPICAL ROOF CANT AT CORNER | SYSTEM HS | DRAWING # 303 |
| | | | SCALE N.T.S. | ISSUE/ REVISION DATE 12-1-16 |

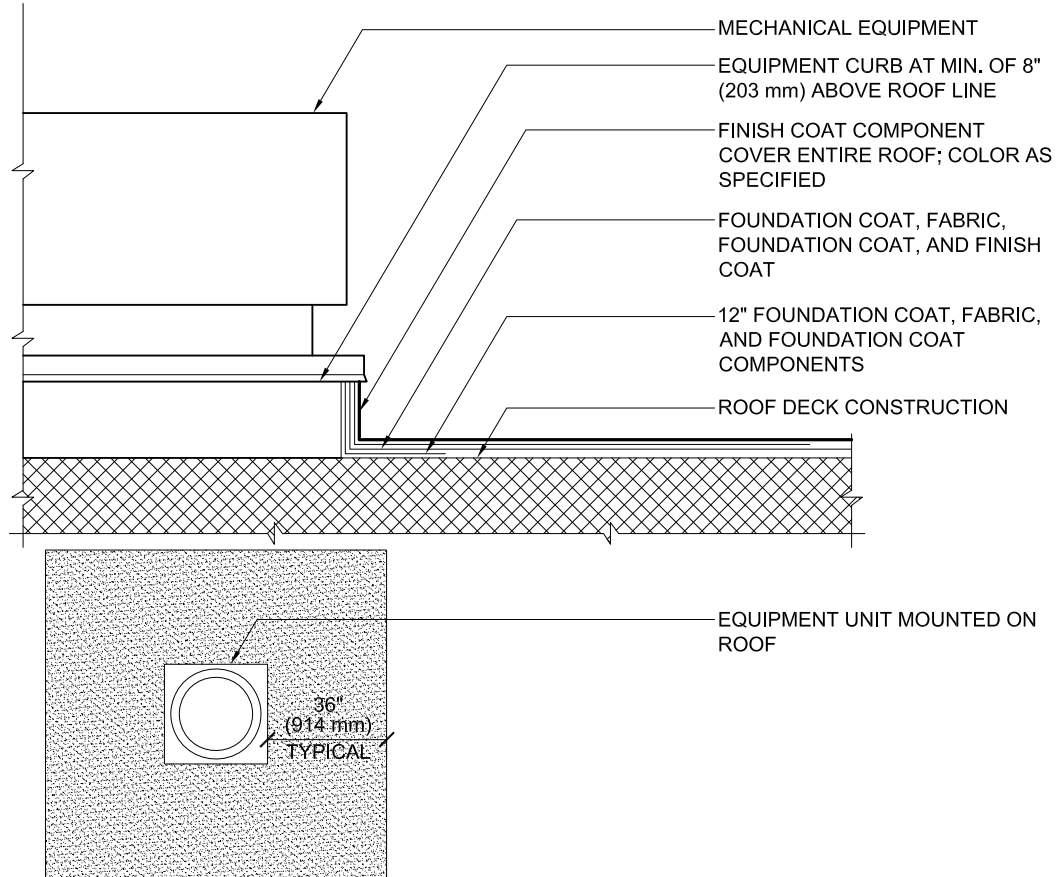

NOTE:

1. THIS DETAIL IS A TYPICAL FLASHING DETAIL AT EQUIPMENT CURBS.
2. PREPARE THE ROOF SURFACE AS PER GAF SPECIFICATIONS PRIOR TO APPLICATION OF ROOF COATING.
3. REFER TO THE SPECIFICATIONS FOR SPECIFIC EXECUTION REQUIREMENTS.
4. PREMIUM COAT® SYSTEM - FOUNDATION COAT, FABRIC, FOUNDATION COAT, AND FINISH COAT COMPONENTS.
5. PRIMING - REFER TO HYDROSTOP® SPECIFICATIONS FOR DECK PRIMING REQUIREMENTS.

| | | | | |
|---|--|---|------------------------------------|--|
|  <small>www.gaf.com 1 Campus Drive Parsippany, NJ 07054</small> |  WALL & CURB SERIES | TYPICAL EQUIPMENT CURB FLASHING DETAIL | <small>SYSTEM</small> HS | <small>DRAWING #</small> 304 |
| | | | <small>SCALE</small> N.T.S. | <small>ISSUE/ REVISION DATE</small> 12-1-16 |

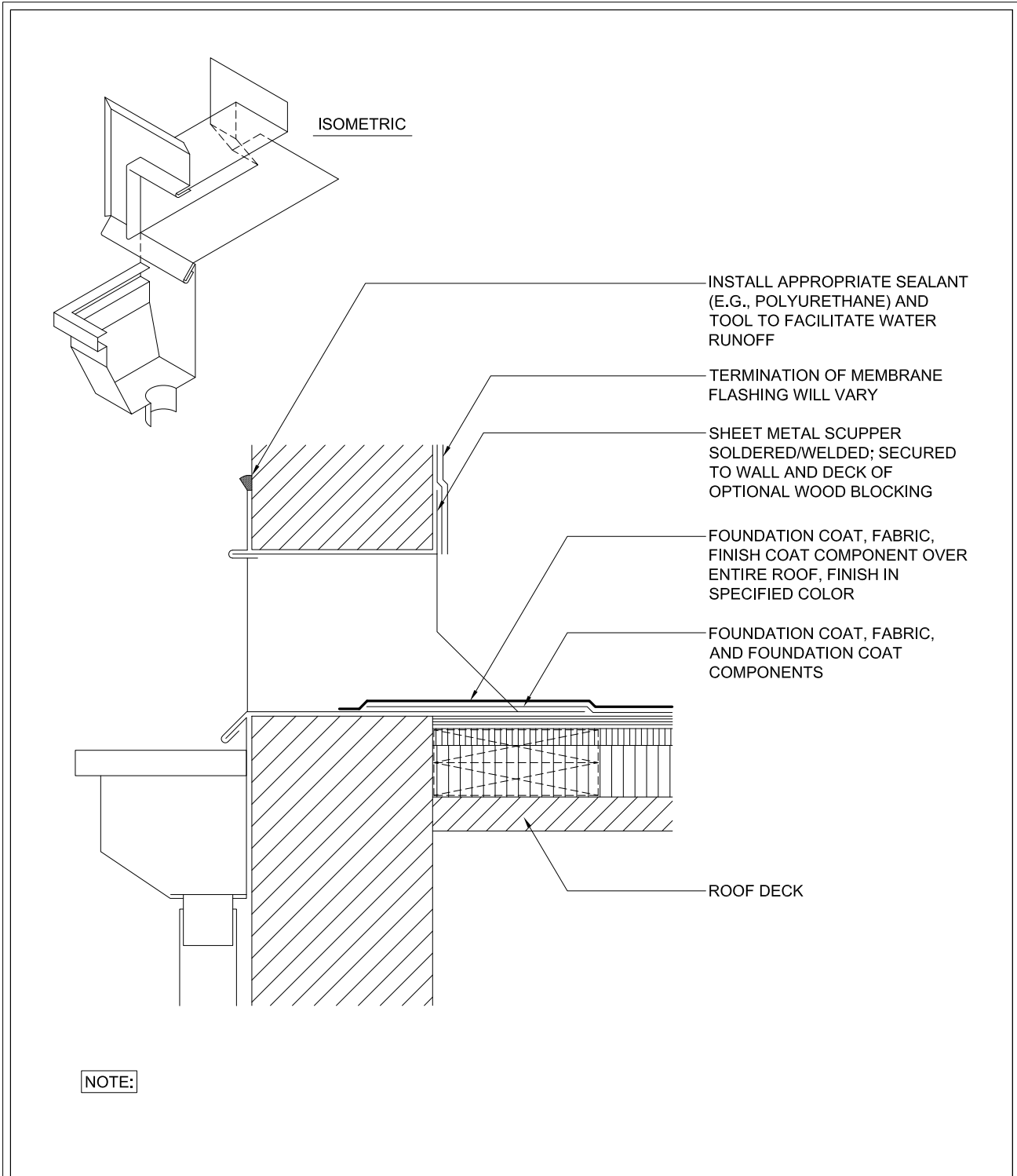

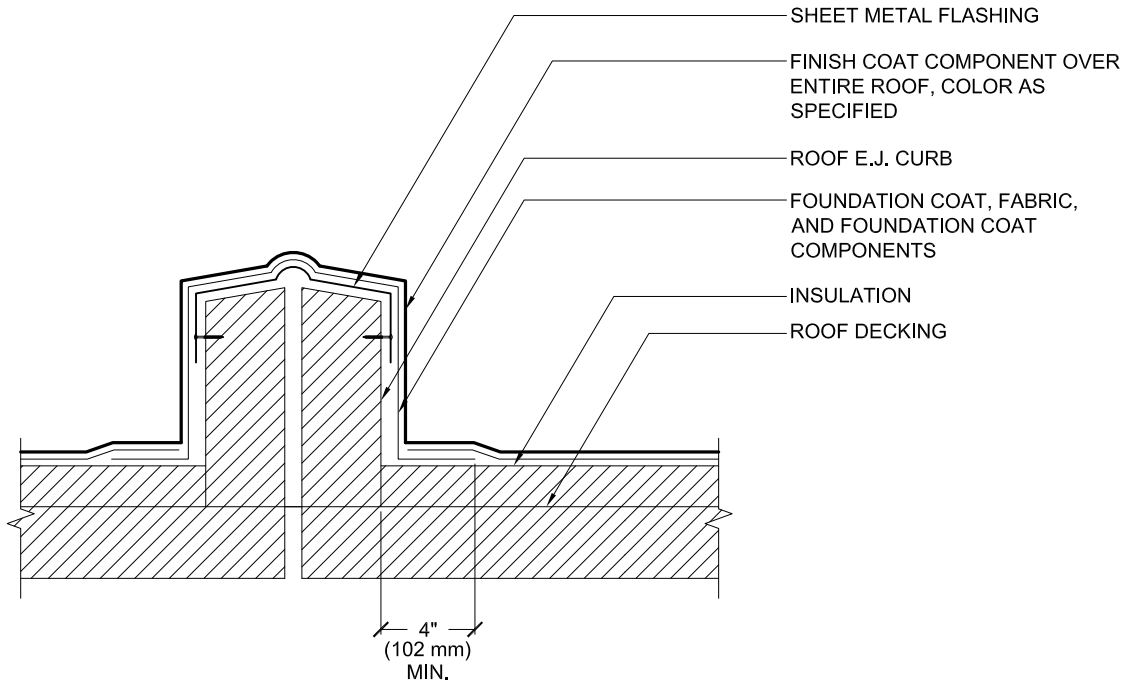

| | | | | | |
|--|---|-----------------------|--------------------------------|---------------------|-------------------------|
|  <small>www.gaf.com</small> 1 Campus Drive Parsippany, NJ 07054 | HYDROSTOP WALL & CURB SERIES | SCUPPER DETAIL | | SYSTEM HS | DRAWING # 305 |
| | | SCALE N.T.S. | ISSUE/ REVISION DATE 6-1-16 | | |



NOTE:

1. PREPARE ALL SURFACES IN ACCORDANCE WITH GAF SPECIFICATIONS.
2. SHEET METAL FLASHING AND EXPANSION JOINT DESIGN PROFILE TO BE DETERMINED BY ROOF DESIGNER.
3. PREMIUM COAT® SYSTEM - FOUNDATION COAT, FABRIC, FOUNDATION COAT, AND FINISH COAT COMPONENTS.
4. PRIMING - REFER TO HYDROSTOP® SPECIFICATIONS FOR DECK PRIMING REQUIREMENTS.

| | | | | |
|---|---|--|-----------|----------------------|
|  <small>www.gaf.com 1 Campus Drive Parsippany, NJ 07054</small> |  EXPANSION JOINT SERIES | CURB TO CURB EXPANSION JOINT FLASHING DETAIL | SYSTEM | DRAWING # |
| | | | HS | 401 |
| | | | SCALE | ISSUE/ REVISION DATE |
| | | | N.T.S. | 12-1-16 |

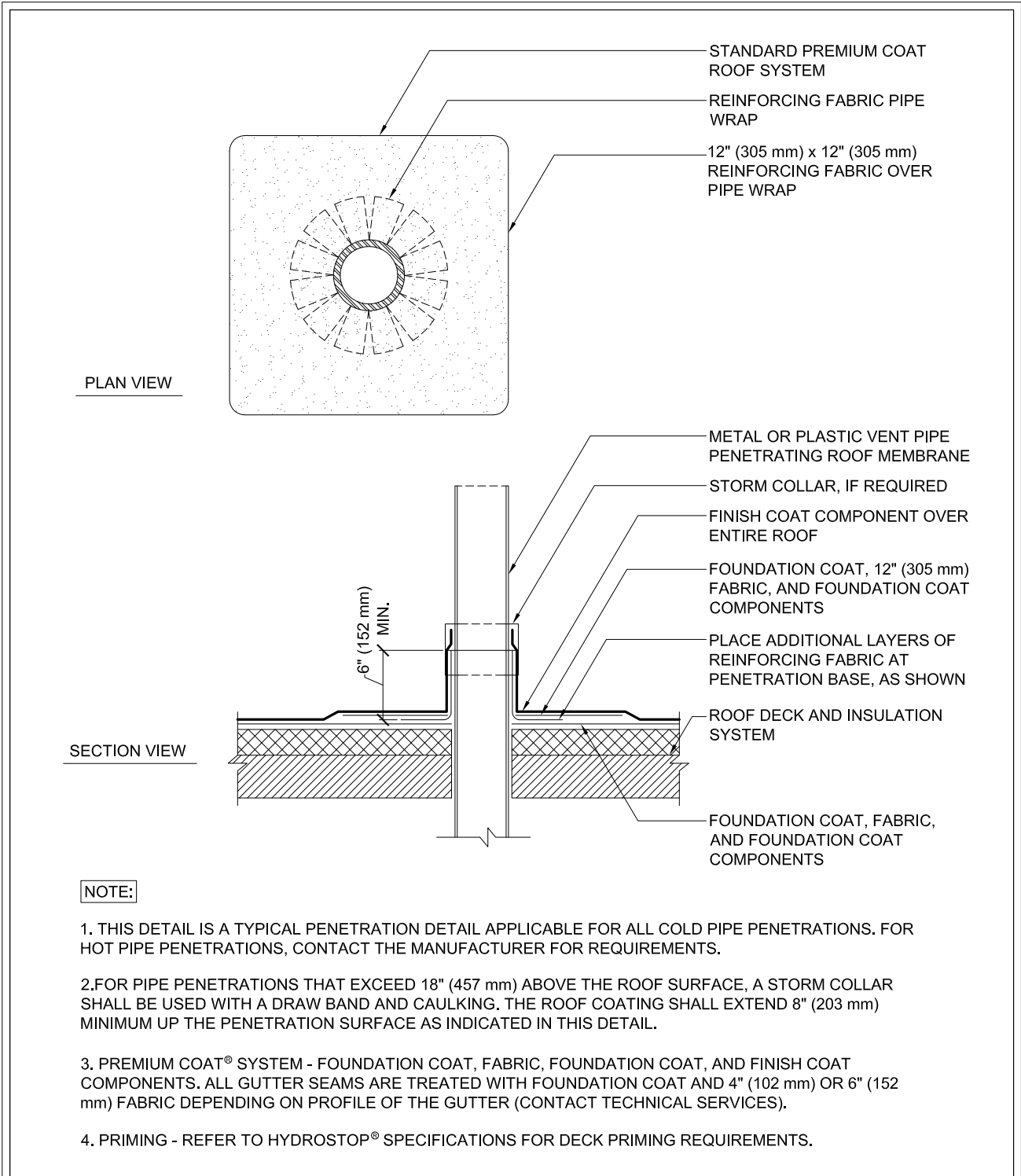

| | | | | |
|--|-------------------------|----------------------------------|---------------------|---------------------------------|
|  <small>www.gaf.com</small> 1 Campus Drive Parsippany, NJ 07054 | HYDROSTOP | VENT-PIPE FLASHING DETAIL | SYSTEM HS | DRAWING # 502 |
| | ROOF PENETRATION SERIES | | SCALE N.T.S. | ISSUE/ REVISION DATE 12-1-16 |

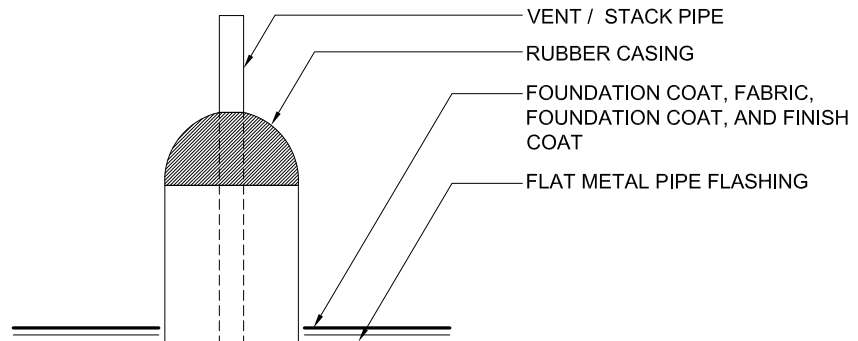
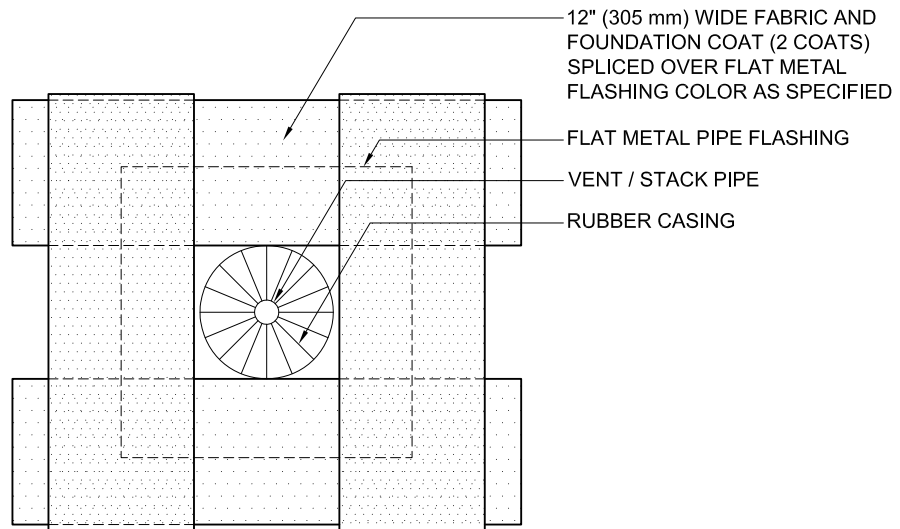

NOTE:

1. ALL FLASHING SHALL BE DESIGNED FOR THE APPLICABLE CONDITIONS. METAL THICKNESS, FASTENERS, AND LAPPING SHALL BE AS SPECIFIED BY THE ROOF DESIGNER.
2. REFER TO THE SPECIFICATIONS FOR SPECIFIC EXECUTION REQUIREMENTS.
3. PREMIUM COAT® SYSTEM - FOUNDATION COAT, FABRIC, FOUNDATION COAT, AND FINISH COAT COMPONENTS.
4. PRIMING - REFER TO HYDROSTOP® SPECIFICATIONS FOR DECK PRIMING REQUIREMENTS.

| | | | | |
|--|--|----------------------------|---------------------------------|-------------------------|
|  <small>www.gaf.com</small> 1 Campus Drive Parsippany, NJ 07054 | HYDROSTOP ROOF PENETRATION SERIES | VENT-STACK FLASHING DETAIL | SYSTEM HS | DRAWING # 503 |
| | | SCALE N.T.S. | ISSUE/ REVISION DATE 12-1-16 | |

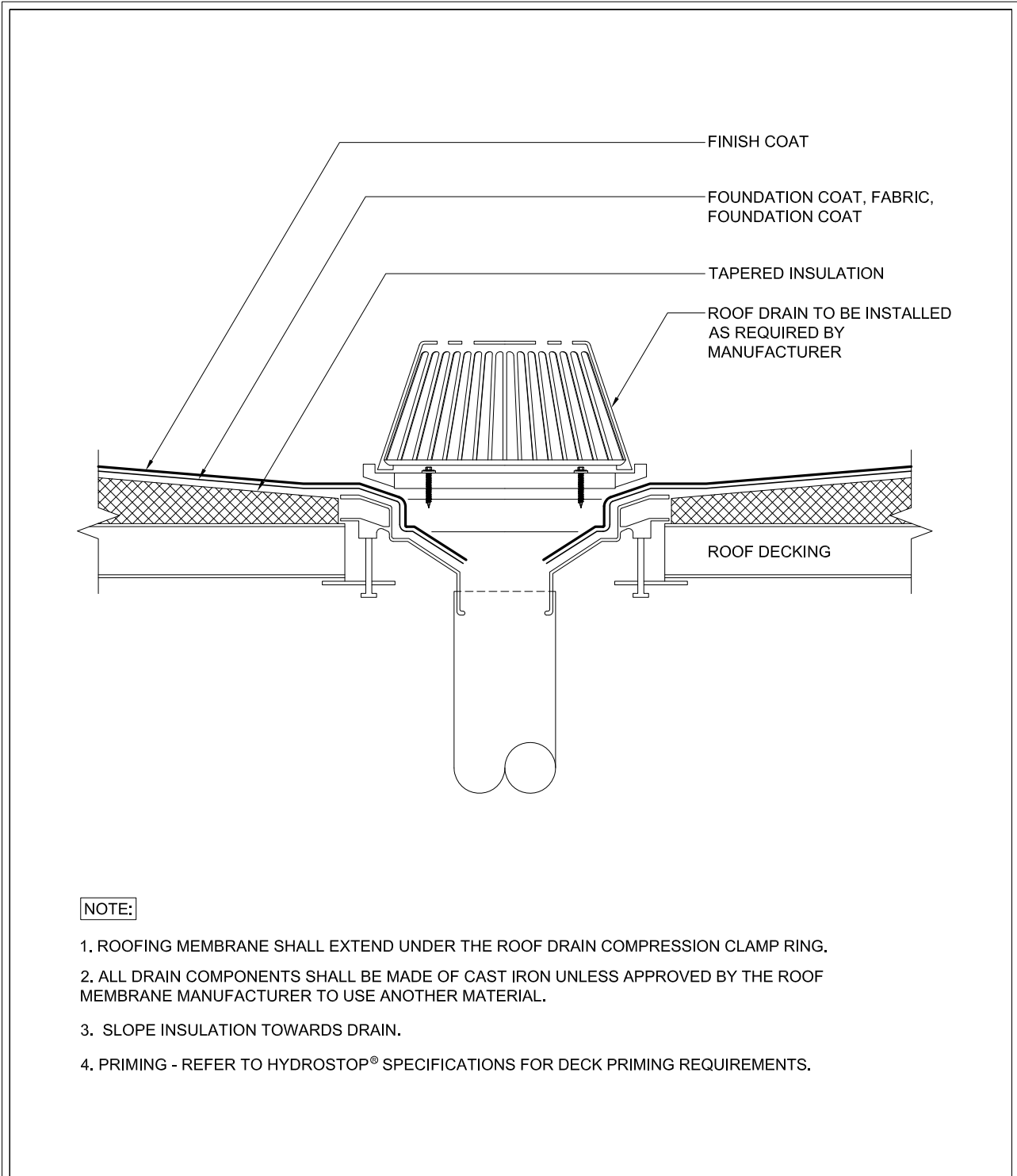

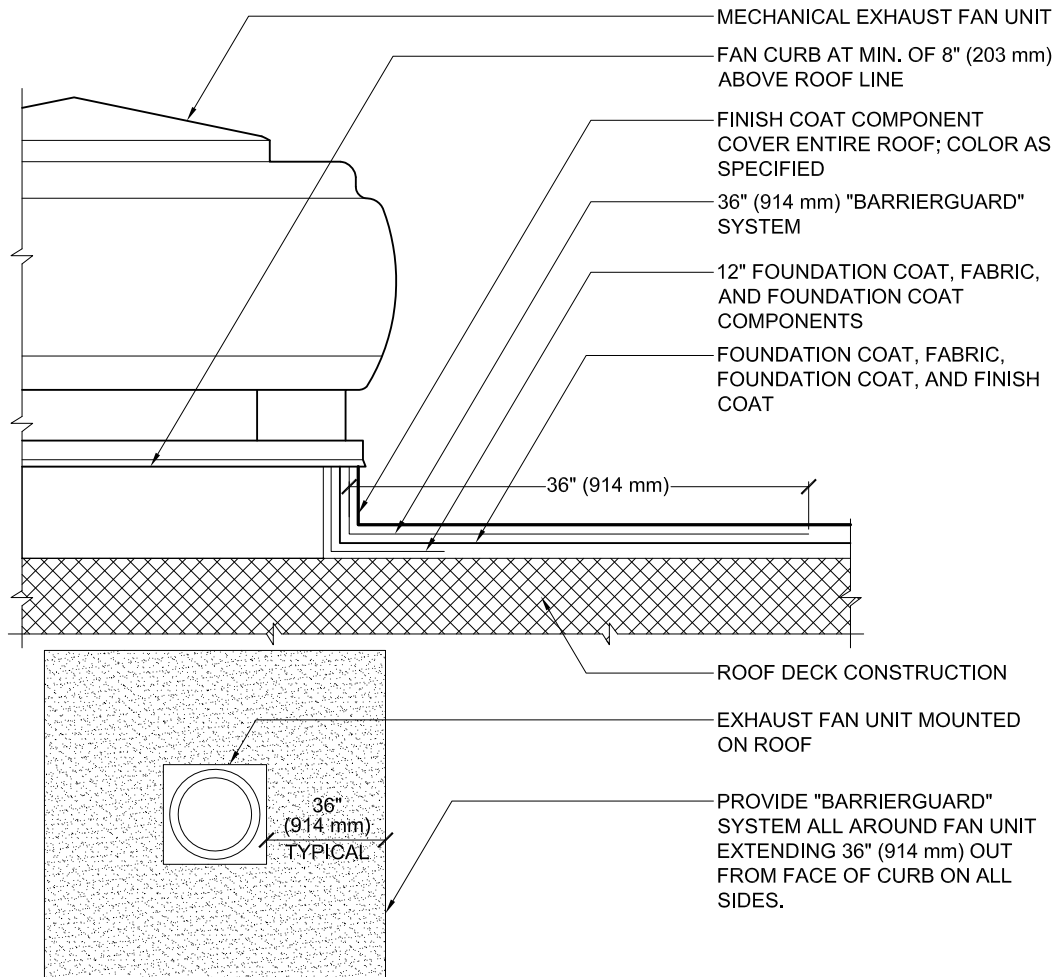

| | | | | |
|---|----------------------------|-----------------------------------|---------------------|-------------------------|
|  <small>www.gaf.com 1 Campus Drive Parsippany, NJ 07054</small> | HYDROSTOP | STANDARD ROOF DRAIN DETAIL | SYSTEM HS | DRAWING # 504 |
| | ROOF PENETRATION SERIES | | | SCALE N.T.S. |



NOTE:

1. THIS DETAIL IS A TYPICAL FLASHING DETAIL AT EXHAUST FANS FOR COOKING. "BARRIERGUARD" SYSTEM IS NOT USED FOR STANDARD EXHAUST FANS.
2. PREPARE THE ROOF SURFACE AS PER GAF SPECIFICATIONS PRIOR TO APPLICATION OF ROOF COATING.
3. REFER TO THE SPECIFICATIONS FOR SPECIFIC EXECUTION REQUIREMENTS.
4. PREMIUM COAT® SYSTEM - FOUNDATION COAT, FABRIC, FOUNDATION COAT, AND FINISH COAT COMPONENTS.
5. PRIMING - REFER TO HYDROSTOP® SPECIFICATIONS FOR DECK PRIMING REQUIREMENTS.

| | | | | |
|---|--|---|--|--|
|  <small>www.gaf.com 1 Campus Drive Parsippany, NJ 07054</small> |  ROOF PENETRATION SERIES | EXHAUST FAN (FOR COOKING) FLASH DETAIL | SYSTEM | DRAWING # |
| | | |  SCALE N.T.S. | 505 ISSUE/ REVISION DATE 12-1-16 |

NOTES

NOTES