

STEP 1:

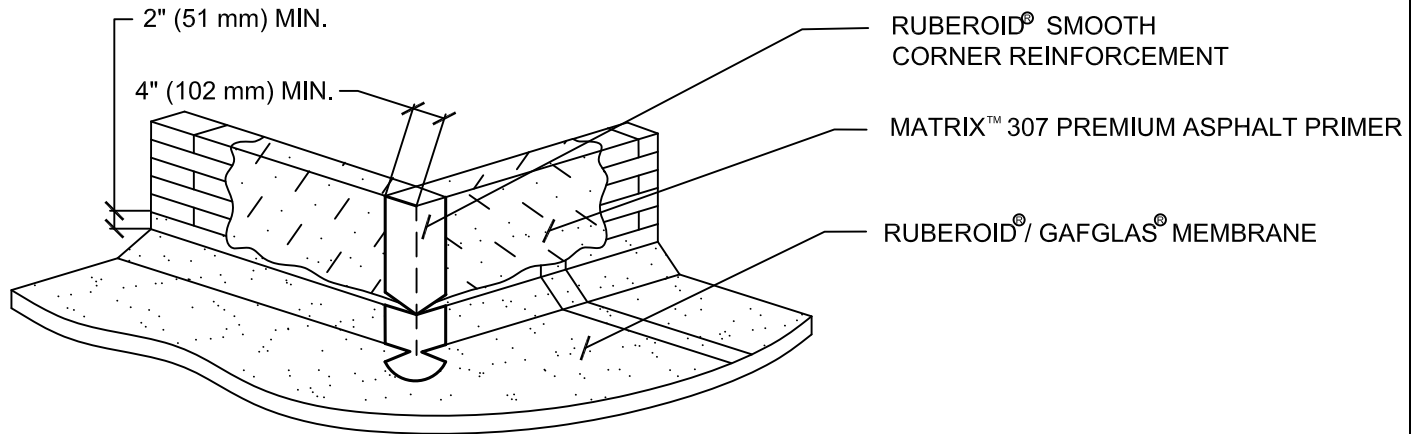

STEP 2:

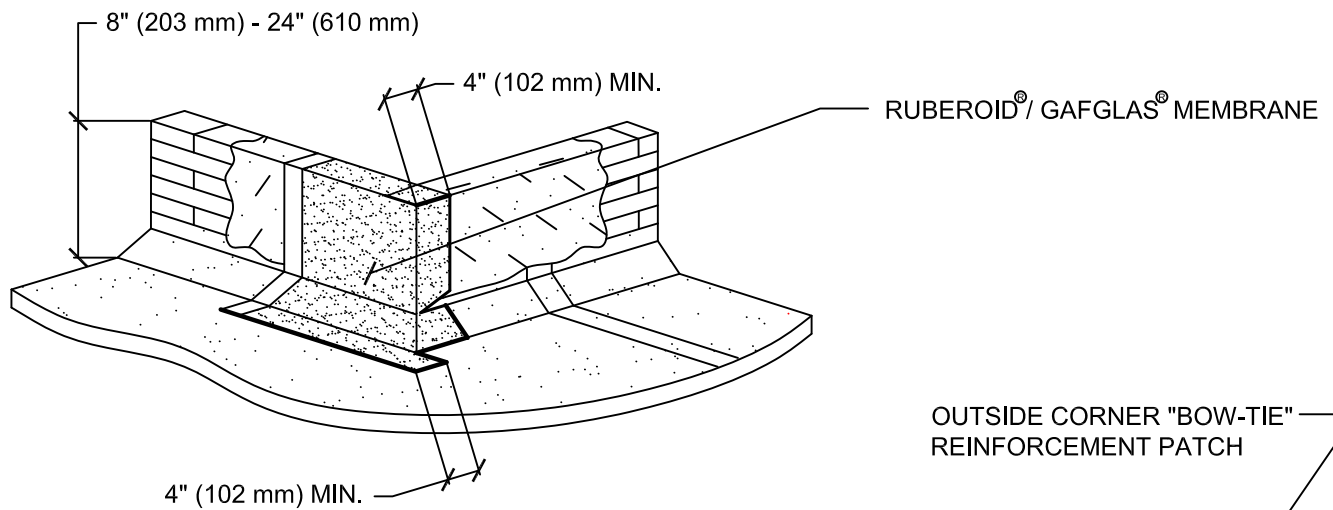

STEP 3:

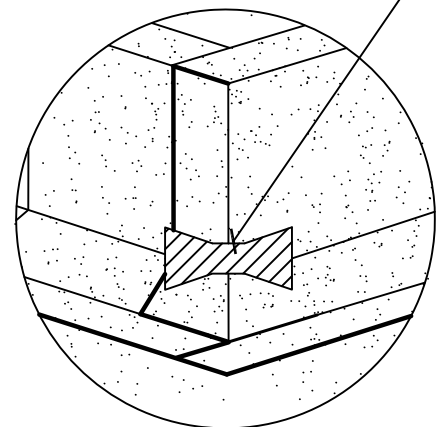
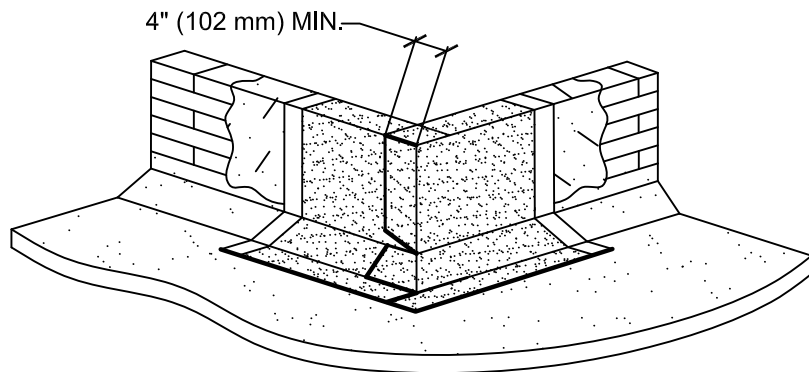

GAFGLAS[®]
Built-Up Roofing Systems
RUBEROID[®]
Modified Bitumen Roofing Systems

OUTSIDE CORNER DETAIL

DRAWING #

12

SYSTEM

MB/BUR

SCALE

N.T.S.

ISSUE/ REVISION DATE

7-01-14