



Quality You Can
Trust...From
North America's
Largest Roofing
Manufacturer!™

Version 1.0

RUBEROID® SBS HEAT- WELDED

Roofing Systems Application & Specifications Manual

gaf.com



RUBEROID® SBS Heat-Welded Roofing Systems

This Manual contains the following sections:

	Page
Welcome.....	4
Guarantee Program	6
Roof Design	8
Key to Specification Numbers.....	42
System Configurations	45

GENERAL INSTALLATION REQUIREMENTS:

Part 1- General

1.01 Work Conditions.....	68
1.02 Pre-Job Conference.....	69
1.03 Delivery, Storage, and Handling.....	69
1.04 Regulatory Requirements	70
1.05 Quality Control of Application.....	70
1.06 Safety Considerations and Warnings	71

Part 2- Inspection

2.01 General.....	74
2.02 Roof Decks	74
2.03 Re-Cover Systems.....	75
2.04 Reroofing – Tear-Off	76

Part 3- Asphalt

3.01 General.....	76
3.02 Asphalt Type	76
3.03 Asphalt Application Rate.....	77
3.04 Asphalt Heating	78

RUBEROID® SBS Heat-Welded Roofing Systems

Part 4- Fastening

3.01 General.....	78
3.02 Fastener Type	79
3.03 Fastener Plates	81

Part 5- Vapor Retarder Installation

5.01 General.....	81
5.02 Steel Decks	82
5.03 Non-Nailable Decks.....	82
5.04 Wood and Structural Wood Fiber Decks	83
5.05 Lightweight Insulating Concrete or Poured Gypsum Decks	83

Part 6- Steep-Slope Requirements

6.01 General.....	83
6.02 Wood Nailers on Slopes of 1/2:12 but Less than 2:12.....	84
6.03 Wood Nailers on Slopes of 2:12 to 3:12	86
6.04 Wood Nailers on Slopes Greater than 3:12.....	85
6.05 Insulation Installation.....	85
6.06 Membrane Installation.....	85

Part 7- Insulation Installation

7.01 General.....	86
7.02 Additional Layers of Asphalt-Applied or Mechanically Fastened Insulation	88
7.03 New Construction/Tear-Off Installation with GAF's Low-Rise Foam Adhesives	88
7.04 Re-cover Installations with GAF's Low-Rise Foam Adhesives.....	90
7.05 Roof Tape	90

RUBEROID® SBS Heat-Welded Roofing Systems

INSTALLATION REQUIREMENTS: RUBEROID® SBS HEAT-WELDED ROOFING SYSTEMS

Part 8- Membrane System Installation

8.01 General.....	91
8.02 Phasing	92
8.03 Base Sheets- Mechanically Fastened.....	92
8.04 Base/Interply Sheets- Hot-Asphalt Application.....	93
8.05 Liberty™ SBS Self-Adhering Base/Ply Sheet and WeatherWatch® XT Leak Barrier Application	94
8.06 GAFGLAS® Stratavent® Perforated Venting Base Sheet	95
8.07 RUBEROID® SBS Heat-Welded Membrane Application.....	95

Part 9- Flashing

8.01 General.....	96
9.02 Cant Strips and Wood Nailers	97
9.03 Sheet Metal	98
9.04 RUBEROID® Heat-Welded Flashing Membrane Application.....	99
9.05 RUBEROID® UltraClad® Torch-Applied SBS Foil-Faced Flashing Membranes	100

Part 10- Surfacing

10.01 General	102
10.02 Gravel Surfacing Cold-Applied with Matrix™ Adhesive	102
10.03 Walkways	102

Part 11- Cold-Weather Application Precautions

11.01 General	103
---------------------	-----

Roofing System Maintenance.....	104
---------------------------------	-----

Welcome

Thank you for consulting the Version 1.0 of the RUBEROID® SBS Heat-Welded Roofing Systems Application & Specifications Manual. You can find further information at gaf.com, or contact GAF Technical Services at 1-800-ROOF-411 (1-800-766-3411).

WHO IS GAF?

Founded in 1886, GAF has grown to become North America's largest manufacturer of commercial and residential roofing.* Professional roofing contractors have long preferred the rugged, dependable performance that only a GAF roof can offer, and have made it the #1-selling brand in North America. Our success in growing the company to nearly \$3 billion in sales has been based on our unique philosophy of helping our customers.

For roofing contractors and distributors:

- Helping to build your business and avoid hassles

For property owners & architects:

- Helping to ensure your best and safest choice in roofing

WHAT ARE OUR PRODUCTS AND SERVICES?

No one offers a wider range of reliable, proven, cost-effective roofing solutions:

COMMERCIAL PRODUCTS

- EverGuard Extreme® TPO Single-Ply Roofing Systems
- EverGuard® TPO and PVC Single-Ply Roofing Systems
- EverGuard® Freedom™ TPO Self-Adhering Roofing Systems
- RUBEROID® SBS and APP Modified Bitumen Roofing Systems
- RoofMatch™ SBS and APP Membranes in select colors
- Liberty™ SBS Self-Adhering Modified Bitumen Roofing Systems
- GAFGLAS® Fiberglass Built-Up Roofing Systems
- TOPCOAT® Liquid-Applied Roofing Systems
- GardenScapes™ Roofing... Hassle-free Garden Roofing System

RESIDENTIAL PRODUCTS

- Lifetime Designer Shingles... Camelot®, Camelot II®, Slateline®, Grand Canyon®, Grand Sequoia®, Grand Sequoia® IR, Sienna®, Woodland®, and Monaco® Shingles
- Timberline® Lifetime Shingles... Timberline Ultra HD®, Timberline HD®, Timberline® Natural Shadow®, Timberline® American Harvest®, Timberline® Cool Series, and Timberline® ArmorShield™ II Shingles
- 3-Tab Shingles... Marquis WeatherMax® and Royal Sovereign® Shingles
- TruSlate® Roofing... affordable Genuine Slate Roofing System

ACCESSORY PRODUCTS

- We offer an extensive line of accessory products for our roof systems, including: EverGuard® TPO and PVC Prefabricated Accessories; Single-Ply Adhesives, Primers & Sealants; Matrix™ Adhesives and Cements; EnergyGuard™ Insulations; Drill-Tec™ Fasteners; M-Weld™ Preflashed Accessories; Metalastic® Expansion Joint Covers; Lexsuco® Roof System Accessories; Cobra® and Master Flow® Ventilation Products; Timbertex® Premium Ridge Cap Shingles; WeatherWatch® and StormGuard® Leak Barriers; and Shingle-Mate® and Deck-Armor™ Roof Deck Protection.

SERVICES

- Every GAF roofing product benefits from the substantial resources available only from a multibillion-dollar corporation dedicated to roofing. Our 31 plants mean manufacturing expertise. Our extensive R&D organization means a constant focus on product and process improvement. GAF is a team of over 3,000 people dedicated to your roofing satisfaction.
- GAF has a network of sales representatives and distributors to supply and service its quality roofing systems throughout North America.
- Our Technical Helpline is a technical assistance service that allows you to contact us directly to speak with a technical representative about specifications, applications, code approvals, and product information. The Helpline number is 1-800-ROOF-411 (1-800-766-3411).
- Architectural Information Services (AIS) is a specification service that allows you to specify your exact roofing needs and will send you a general specification that outlines your job summary, application method, product description, and detail drawings. The phone number for AIS is 1-800-522-9224.
- Our Tapered Design Group (TDG) is one of the many services available to our customers to help reduce their hassles. We provide tapered insulation take-offs for architects, contractors, and distributors nationwide. Just send your roof plans and specifications to tdg@gaf.com. The phone number for TDG is 1-800-766-3411.
- Visit GAF on the web at gaf.com for extensive product information, specifications, and technical literature.

A FEW THINGS TO CONSIDER...

- This Manual contains the latest information relating to the application of GAF's RUBEROID® SBS Heat-Welded modified bitumen and built-up roofing systems and is based on our years of experience in the commercial roofing field. It has been prepared as a general guide to assist architects, engineers, roofing contractors, and owners in the use of our roofing systems.
- GAF manufactures and sells roofing materials and does NOT practice architecture or engineering. GAF is NOT responsible for the performance of its products when damage to its products is caused by such things as improper building design, construction flaws, or defects in workmanship.
- The design responsibility remains with the architect, engineer, roofing contractor, or owner, and construction details illustrated and described herein are furnished solely for guidance purposes. These guidelines should not be construed as being all-inclusive, nor should they be considered as a substitute for good application practices.
- Under no circumstances does GAF have any liability for expenses arising out of or associated with the pre-existing presence of asbestos-containing materials or any other allegedly hazardous substances or materials upon the roof to which the new GAF roofing materials are being applied.
- Information contained in this Manual is presented in good faith and, to the best of GAF's knowledge, does not infringe upon any patents, foreign or domestic.
- As a part of its continuing efforts to improve the performance of its products, GAF periodically makes changes to its products and application specifications. The Company reserves the right to change or modify, at its discretion, any of the information, requirements, specifications, or policies contained herein. This Manual supersedes all catalogs and previous manuals.
- GAF is Your Best Choice!

Guarantee Program

General

GAF offers roof guarantees for a fee for roofing system specifications published in this Manual when installed by GAF factory-certified low-slope roofing contractors in accordance with the terms and conditions set forth in this Manual, and the procedures for obtaining a guarantee are followed. All EnergyGuard™ insulation, fasteners, preflashed details, expansion-joint covers, asphalt, cements, coatings, and torch accessory products as job appropriate are required for guarantees unless otherwise approved in writing by the Regional Field Services Manager prior to installation.

All guaranteed roofing systems must be flashed in accordance with the GAF flashing requirements and details.

GAF will be the sole judge as to whether or not a roofing guarantee will be issued to cover any proposed or completed roof. The issuance of a guarantee and/or the continued liability thereunder is partly contingent upon payment of established charges.

GAF has no obligation to issue a roofing guarantee on any roof. Any inspection prior to issuance is **solely** for the benefit of GAF. In the event that a roof system does not conform to GAF standards and a guarantee is not issued, no portion of the guarantee fee is refundable.

GAF will not accept Notices of Award of Contract that indicate that the owner or architect has the option to accept or reject the guarantee upon completion of the roof.

Specifications not listed in this Manual may also be eligible for GAF guarantees. For further information on guarantee requirements and for approval of modifications to published specifications, consult with GAF at 800-766-3411.

GAF is NOT responsible for consequential damages in case of roof system failure. GAF has no control over a building's contents, type, quantity, positioning, or protection.

A GAF guarantee cannot be withdrawn once it has been issued, although it may be cancelled subsequently by GAF for violation of its terms and conditions.

Exceptions

A guarantee will not be issued to cover less than the entire roof area of a single building. GAF will not issue a guarantee for any materials covering a deck or surface not specifically listed in this Manual unless GAF has approved such conditions, in writing, prior to application of the roofing material.

A GAF roofing system guarantee will not be issued for the following without prior written approval from the Regional Field Services Manager:

- Over any surface not covered in this Manual
- Over a cold-storage building, unless a ventilated plenum isolates the cold-storage area from the roofing system and substrate
- On storage silos and heated tanks, or domed structures
- On structures having conduit or piping between the roof deck and roofing membrane, unless the conduit or piping is installed in channels below the deck surface
- On roofs that omit or have an inadequate number and spacing of expansion joints or curbs
- When deck material changes direction, different kinds of deck material abut each other, or the building changes direction without an expansion joint
- On systems constructed with insulation not approved by GAF
- On any structure where there is limited or no access to the roof or GAF membranes
- On a roof designed for or used as a water-insulated or spray roof
- On promenade or parking roofs
- On waterproofing applications
- For any structure where high humidity conditions exist such as, but not limited to, breweries, creameries, laundries, textile mills, pulp and paper plants, swimming pools, shower rooms, and canneries
- When roofing over an existing roof system that contains moisture, that is not fully adhered to the substrate or roof deck, and/or provides an improperly prepared surface

- On plywood decks without continuous, solid end-blocking
- On roofs containing sprayed-in-place polyurethane foam
- Any unusual condition not specifically approved by GAF

GAF Roof Guarantee Program

GAF offers an extensive selection of roof guarantees to meet the needs of most building owners. The following guarantees are available for use with selected GAFGLAS®/RUBEROID® and Liberty™ Roof Systems when installed by an eligible GAF factory-certified contractor. Contact GAF Technical Services for additional information and specific guarantee requirements.

GAF Roof Guarantee Type	Coverage	Term
All-American Pledge™ Steep- and Low-Slope Roof Guarantee	NDL	5 to 20 Years
GAF Diamond Pledge™ Roof Guarantee	NDL	5 to 20 Years
GAF System Pledge™ Roof Guarantee	Specified \$ per square	5 to 20 Years
WellRoof® Guarantee Extension*	Extends Diamond Pledge™ Coverage	25% longer term

*A program that encourages property owners to utilize an annual maintenance agreement; when certain requirements are met, GAF will extend its Diamond Pledge™ Guarantee by 25%. Contact Technical Services at 1-800-766-3411 for qualifying specifications and detailed information. All work must be completed by a GAF Certified Maintenance Professional (CMP). See WellRoof® Guarantee Extension for complete coverage and restrictions.

Restoration/Extension/Limited Material Warranties and Guarantees**	Coverage	Term
TOPCOAT® Emerald Pledge™ Limited Warranty	Ltd. warranty with NDL-type coverage on Defective Materials	10 Years
Weather Stopper® Integrated System Limited Warranty	Ltd. warranty with NDL-type coverage on Defective Materials	10 to 20 Years

**Contact GAF Technical Services for additional information and guarantee requirements.

GAF Certified Contractor Program

GAF does not install roofing systems, does not own roofing companies, or have any interest in companies installing roofing systems. Accordingly, GAF shall not be responsible for any roofing contractor’s workmanship except as specifically covered under the terms and conditions of the GAF roofing guarantee.

The term “GAF factory-certified low-slope roofing contractor” only identifies a contractor eligible to apply for a GAF roofing guarantee and is not intended to convey any other meaning. GAF factory-certified low-slope roofing contractors are not employees, agents, or representatives of GAF.

GAF will issue a roofing system guarantee only for roofs applied by a GAF factory-certified low-slope roofing contractor. The responsibility for proper application of the roof lies with the factory-certified low-slope roofing contractor alone. It is the responsibility of the building owner and his designated representatives, as the employer of the factory-certified low-slope roofing contractor, to enforce the compliance with specifications and good workmanship practices, and such enforcement is not an obligation of GAF.

Inspection

GAF will inspect only those roofs where a guarantee is to be issued or where special inspection services have been agreed to be purchased prior to the start of the roof construction, and the current charge for the guarantee or inspection services has been paid. If an inspection is requested and the job is not ready or the owner’s representative is not available, an extra billing will be made at consultation-fee rates.

GAF reserves the right to waive inspection of guaranteed roofs when, in its opinion, inspection is not necessary. In such cases, the owner or designer may request a special inspection for which an additional charge may be made.

Any inspections made by GAF are for its **own use** only and **do not** constitute a waiver of any of the terms and conditions of the guarantee.

Should a GAF inspector observe conditions on the job site that do not conform to the requirements of this Manual or standard good roofing practices, such conditions will be brought to the attention of the roofing contractor and the owner’s representative for corrective action. GAF, in its sole discretion, has the right to require corrective action as it deems necessary to conform to the requirements of this Manual and the requirements for the issuance of the GAF roofing-system guarantee.

Roof Design

Proper roofing-system design and selection requires the consideration of many factors. Although our expertise is in roofing-system design and materials manufacturing, and not in engineering, architecture, or specialized roof consulting, our company has decades of extensive experience in the practical aspects of roofing.

Our experience suggests that careful consideration of the following will provide a fundamentally sound basis for design and selection of GAF roofing systems.

Balanced Performance

All other factors being equal, the most desirable roofing systems tend to be the ones that provide balanced performance, addressing not just the need for a watertight roofing membrane but also any and all other factors that are necessary to preserve and enhance the rooftop environment and the building as a whole.

Basic Considerations

Most roofing applications are relatively straightforward. Balanced performance considerations include the physical durability of the roofing membrane, the energy savings associated with roofing insulation, and the drainage capabilities of the roof. The following design elements are typically considered:

- Membrane design/number of plies as a measure of durability and longevity
- Insulation thermal resistance to save energy loss through the roof
- Need to add or enhance roof-drainage capabilities by means of tapered board or cellular concrete insulation system, or additional drain points
- Compliance with applicable building codes

Additional Considerations

However, some roofing applications are more complex. Balanced performance considerations may require that a significant portion of available funds be dedicated to additional factors that involve building elements other than the roof system. Not addressing the overall rooftop environment and building structure will often cause a roofing system to fail to live up to expectations, and lead to an accelerated roof-replacement schedule. Although not an exhaustive list, the following additional design elements may typically require consideration:

- Replacement of damaged roof decking or structural components
- Improvement of roof access
- Removal of unused rooftop equipment and associated equipment mountings
- Remounting of rooftop equipment to allow proper roofing and flashing technique
- Matching of architectural elements such as special perimeter metalwork
- Repair of deteriorated parapet and penthouse walls
- Protection of roofing membrane by means of walkway pad system

Installed vs. Life-Cycle Costs

Many factors enter into the establishment of a roofing budget and selection of a roofing system. One of the more sophisticated decision methods involves comparing the initial installed costs of various roofing systems to their projected total costs over a longer period of time. Often, the roofing system that has the lowest initial cost will cost more over time due to a shorter life expectancy and related additional costs of roofing replacement.

Installed Cost

Factors favoring the primary consideration of initial installed cost include:

- Limited availability of funds
- Limited period of building ownership/anticipated sale
- Limited period of building occupancy for tenants responsible for roof maintenance
- Accounting practices and/or tax considerations

Life-Cycle Cost

Usually, however, installing the highest-quality roofing system that satisfies budgetary restraints is recommended. Factors favoring the consideration of long-term ownership cost include:

- Longer life expectancy
- Reduced need for repair
- Lower incidence of water infiltration problems

There are various computerized models available that will analyze installed cost compared to life-cycle cost; the best of these models consider relative energy savings, time value of money, material disposal costs, and maintenance expenditures to provide the most accurate comparison.

Building Construction

Building construction can have a significant impact on roofing-system selection and design. Building construction can be generalized into two basic categories:

Rigid Construction

Rigid construction is primarily based on reinforced concrete, solid brick masonry and stone, and structural steel with solid masonry walls. Rigid construction is characterized by limited building movement, as well as limited movement between exterior walls and roof deck. Roof decks associated with rigid construction are most commonly cast-in-place concrete, precast concrete units, steel pan with insulating cellular concrete, poured gypsum, and wood plank.

Rigid construction lends itself to the following roof-system design considerations:

- Higher load-carrying capacity with less deflection, allowing use of ballast or pavers as finish surface
- Difficulty in mechanical attachment into deck, encouraging use of adhered roofing materials
- Limited need to accommodate movement between roofing membrane and flashings

Flexible Construction

Flexible construction is primarily based on structural steel with curtain walls, wood or steel framing, tilt-up wall panels, precast concrete, and engineered steel assemblies. Flexible construction is characterized by significant building movement, particularly between exterior walls and roof deck. Roof decks associated with flexible construction are most commonly steel deck, plywood and oriented strand board, and cementitious wood-fiber panels.

Flexible construction lends itself to the following roof-system design considerations:

- Lower load-carrying capacity with more deflection, encouraging use of lightweight roofing materials
- Ease of mechanical attachment into deck, ideal for use of mechanically attached roofing materials
- More need to accommodate movement between roofing membrane and flashings

Building Utilization

Building utilization can have a significant impact on roofing-system selection and design. The most common building utilization considerations are as follows: extremes in internal temperature/humidity, positive internal pressure, rooftop traffic/abuse, rooftop-exhausted contaminants, and the use of the roof as recreational space.

Internal Temperature/Humidity

Extremes in internal temperature/humidity are most often associated with cold storage/freezer buildings, swimming pool facilities, laundries, car washes, wet process manufacturing facilities, drying kilns, food-processing plants, paper/pulp mills, and smelting/blasting furnace facilities. What makes these building applications unusual is that the pronounced difference in vapor pressure between the building interior and the exterior can cause a pronounced vapor drive through the roof assembly. This can result in a significant build-up of condensation within the roof assembly, and severe deterioration of both the roof assembly itself and the structural deck.

Because of the uniqueness of the temperature and humidity conditions, GAF will not issue guarantees on these types of buildings.

Physical Abuse

Roofing installations that can be expected to experience a high degree of roof traffic due to equipment maintenance, vandalism or other unauthorized access, frequent hailstorms or high winds, and prolonged periods of temperature extremes or rapid fluctuations in temperature will require a more durable roofing system.

Relevant design considerations include:

- Use of thicker membrane accessories or additional base plies
- Use of a higher compressive-strength insulation substrate
- Application of a walkway system for areas of high traffic

Contamination

Many roofing installations are exposed to oil, grease, and chemical contamination in excess of normal airborne contaminants. These conditions are most often associated with restaurants, food-processing plants, chemical and pharmaceutical plants, refineries, machining and manufacturing facilities, and airports. Most roofing materials are degraded by certain families of contaminants and will become brittle, swell and soften, or dissolve, depending on the contaminant type, concentration, and degree of exposure. Long-term exposure testing of roofing material and specific contaminant remains the preferred method of determining material resistance. Even then, unforeseen combinations of contaminants, environmental exposure effects, and variations in contaminant concentration prevent an absolute prediction in all but the most common situations.

Relevant design/maintenance considerations include:

- Use of containment pans or equipment
- Isolation of contaminated roof area with expectation of more frequent roof membrane replacement
- Periodic cleaning of the roofing membrane
- Limitation of rooftop spillage/exhaust of contaminating materials

Specialized Application

Full utilization of the roof is increasing, particularly in urban areas where space is at a premium. Plaza deck roofing utilizing concrete pavers and landscape (or garden) roofing are two of the most common specialized roofing applications. Proper drainage and physical protection of the roofing membrane are critical considerations. Polymeric drainage boards and geotextile fabrics in multiple layers are commonly used to address these considerations. The performance of a flood test prior to the application of any materials above the roofing membrane is also critical; repair of the roofing membrane once the drainage, protection, and overburden layers have been installed is impractical and expensive, and is to be avoided at all costs.

Every specialized roofing application has its own requirements. Design consideration for these applications is beyond the scope of this Manual.

Fire Resistance

Resistance of the roofing system to fire applied to the exterior roof surface is important. Typically, a UL Class A, B, or C rating is required by building code. Occasionally, depending on the use of the building, special resistance to fire occurring within the building is required. This is normally expressed in the form of hourly ratings, and usually requires the use of a tested roof assembly.

Reference to current GAF listings in the appropriate UL directory is recommended to verify roof assembly requirements for specific fire ratings. The following are general considerations to be followed when reviewing roof assemblies for fire ratings:

Construction Type and Deck Slope

- Non-combustible decks include steel, structural concrete, lightweight insulating concrete, gypsum concrete, and cementitious wood fiber
- Combustible decks include wood, plywood, and oriented strand board
- The greater the roof slope, the more directly a fire will act upon the roof surface, and the more difficult it will be for a roof system to achieve a specific fire rating

Existing Roofing Over Non-Combustible Decks

- Determination of the UL classification of the existing roof is required
- In many cases, UL Class A, B, or C roof systems with insulation installed over existing roofing will maintain their new UL Classification rating
- All UL Class A, B, or C roof systems without insulation installed over existing roofing require special evaluation based upon the existing roof-system assembly

Existing Roofing Over Combustible Decks

- Determination of the UL classification of the existing roof is required
- All UL Class A, B, or C roof systems with insulation installed over existing UL Class A, B, or C-rated roofing will retain the lesser of the new or existing UL Classification ratings
- In many cases, combustible deck-rated UL Class A, B, or C roof systems with insulation installed over existing roofing will maintain their new UL classification rating
- All UL Class A, B, or C roof systems without insulation installed over existing roofing require special evaluation based upon the existing roof system assembly

The following are common fire codes and approvals typically used in conjunction with GAF roofing systems:

Underwriters Laboratories Class A, B, C

- Primary testing is based on ANSI/UL 790, which is similar to and meets all criteria of ASTM E108. Tests for all decks measure flame spread on exterior surface of roof assembly
- Additional testing for combustible decks is also based on ANSI/UL 790 which measures burn-through resistance from exterior through roof system/roof deck assembly
- Ratings provided in Underwriters Laboratories Roofing Materials and Systems Directory as "Class A," "Class B," and "Class C" assemblies (Class A is the most fire-resistant rating)
- Many GAF roofing systems are available with a Class A, B, or C rating from UL
- Roof deck/roof system assemblies must be constructed in exact accordance with the components listed for each rated assembly; no material substitutions are allowed
- UL ratings are required by building codes for most building applications

Underwriters Laboratories Hourly Ratings

- Testing based on ANSI/UL 253, which is similar to ASTM E119; measures burn-through resistance from interior through exterior of ceiling-roof/deck-roof system assembly
- Ratings provided in Underwriters Laboratories Fire Resistance Directory as "P-Number" assemblies
- Ratings may be available with GAF roofing systems of 1 to 3 hours, depending on the deck and insulation configuration
- Ceiling-roof/deck-roof system assemblies must be constructed in exact accordance with the components listed for each P-Number assembly; no material substitutions are allowed
- Hourly ratings are required by building codes for special building applications, and are usually not specified if not specifically required by code

Factory Mutual Approved Guide

- Testing based on ASTM E108; measures flame spread on exterior surface of roof assembly
- Ratings provided in Factory Mutual Approval Guide, typically as part of a comprehensive roof-system approval that also includes wind and hail resistance as other major test criteria
- Many GAF roofing systems are available with a Class A rating from Factory Mutual
- Roof deck/roof system assemblies must be constructed in exact accordance with the components listed for each rated assembly; no material substitutions are allowed
- ASTM E108 Class ratings are required by building codes for most building applications, and are to be provided as part of an overall FM roof-system approval

Wind Performance

Resistance by the roofing system to wind forces is an obvious requirement. Ideally, roofing systems should be capable of resisting the forces generated by the maximum anticipated wind speed for a specific building. One widely accepted method for specifying wind performance is to require an FM 1-60, 1-90, or higher rated system as appropriate for a specific building based upon location, exposure, etc. In general, additional securement of the roofing insulation can accommodate most requirements.

The following are general considerations to be followed when reviewing roof assemblies for wind ratings. Note: ASCE 7 is an alternative reference to the Factory Mutual Loss Prevention Data Sheets (LPDS):

- Location**
 - Coastal and mountainous locations generate higher wind speeds and, therefore, greater wind-related forces
 - Reference Factory Mutual Loss Prevention Data Sheet 1-28 for wind-speed map

- Terrain**
 - Surrounding terrain that provides shielding or otherwise disturbs wind flow reduces wind energy that reaches the roof system
 - Refer to FM LPDS 1-28 for full descriptions of the following three defined terrain exposures:
 - Exposure B - Suburban areas surrounded by buildings and vegetation of similar height
 - Exposure C - Open areas without significant obstructions to wind
 - Exposure D - Coastal areas directly exposed to large bodies of water

- Height**
 - Increased building height exposes roof systems to higher wind uplift forces that are present with higher roof locations
 - Refer to FM LPDS 1-29 for design tables that correlate wind-uplift forces to geographic location, surrounding terrain, and building height

- Construction Type**
 - Buildings with porous deck-types will allow internal air pressure to affect the underside of the roof system, effectively increasing the overall forces being applied to the roof system
 - The installation of an air barrier over porous decks can effectively seal the deck and reduce the internal air pressures from reaching the roof system
 - The installation of an air barrier or other means of addressing the following combination of building conditions is required:
 - Air-permeable deck, i.e., steel, wood, and cementitious wood fiber, and excessive internal pressurization of building
 - Air-permeable deck, i.e., steel, wood, and cementitious wood fiber, and openings in perimeter walls that exceed 25% of the wall area, such as aircraft hangers, distribution centers, etc.

Roof Regions

- Wind pressures are increased in the corners of the roof and have increased pressures acting along the remaining roof perimeter; the remaining field area of the roof normally experiences significantly lower wind pressures than either the corner or perimeter areas
- Refer to FM LPDS 1-28 for guidelines regarding roof areas

Roof Slope

- Roof slopes in excess of 10% begin to create an additional ridge area of higher wind pressure, and create separate windward and leeward conditions
- Refer to FM LPDS 1-28 for guidelines regarding roof areas

Parapet Walls

- Parapet walls in excess of 3' (914 mm) height can reduce and even effectively eliminate corner regions from the roof, but tend to widen the perimeter region
- Refer to FM LPDS 1-28 for guidelines regarding the effect of parapet walls on roof regions

The following are common uplift tests and levels of performance typically used in conjunction with GAF roofing systems:

Factory Mutual Research Wind Ratings

- Testing based on method described in Approval Standards 4450 and 4470
- Test deck size is typically 12' x 24' or 5' x 9' (3.6 m x 7.3 m or 1.5 m x 2.7 m)
- Measures resistance to upward pressures applied to the roof system
- Ratings equate to design pressures by a 2:1 factor of safety:

1-60	=	30 psf design pressure
1-75	=	37.5 psf design pressure
1-90	=	45 psf design pressure
1-105	=	52.5 psf design pressure
1-120	=	60 psf design pressure
- Higher ratings are available in 15 psf increments

Underwriters Laboratories Wind Ratings

- Testing based on UL 580
- Sample size is 10' x 10' (3.05 m x 3.05 m)
- Measures resistance to a combination of negative pressure applied to the top surface of the roof system and oscillating positive pressure applied to the underside of the roof deck
- Ratings provided in Underwriters Laboratories Roofing Materials and Systems Directory as "Roof Deck Constructions." Class-15, Class-30, Class-60, and Class-90 ratings are provided.

Underwriters Laboratories Wind Ratings

- UL Wind-Class ratings are primarily utilized for testing metal roof and deck panels
- UL Wind-Class ratings are not required by building codes
- GAF roofing systems have not been evaluated using this test method

American Society of Civil Engineers ASCE 7 Wind Design

- A comprehensive building load standard; section 6 means to analyze wind forces acting on buildings
- Requires detailed calculations to determine actual wind pressures at different regions of the roof
- Referenced by building codes

Energy Efficiency

Thermal transmission standards have been established by building codes for most buildings. Roof insulation installed above the roof deck is a practical means of achieving the necessary energy efficiencies. In addition, the use of white-colored reflective membranes can reduce the heat load on air-conditioning equipment, as well as provide a moderating effect on the temperature in proximity to the building.

Thermal transmission measurements and comparisons are referenced in various ways. The following is a description of common terminologies:

K-Value

- Thermal Conductivity – the number of BTUs (energy) that pass through a 1-inch thickness of a 1-square-foot sample of homogenous material in one hour with a temperature difference between the two surfaces of 1°F
- Units of Thermal Conductivity are expressed as: (BTU) (inch)/(h) (sq. ft.) (F)
- Thermal Conductivity only applies to a 1-inch thickness of a material, and as such is a qualitative physical property not directly suitable for determining insulation requirements

C-Value

- Thermal Conductance – The number of BTUs (energy) that pass through a given thickness of a 1-square-foot sample of material in one hour with a temperature difference between the two surfaces of 1°F
- The C-Value is the reciprocal of the R-Value
- Units of Thermal Conductance are expressed as: (BTU)/(h) (sq. ft.) (F)
- Thermal Conductance applies to an actual thickness of a material, and as such is a quantitative physical property that can be used for determining insulation requirements, but normally is not in lieu of the more common R-Value

U-Factor

- Thermal Transmittance – The number of BTUs (energy) that pass through a 1-square-foot sample of a total material assembly in one hour with a temperature difference between the two surfaces of 1°F
- The U-Factor is the reciprocal of the summation of all R-Values for all materials in an assembly

R-Value

- Units of Thermal Transmittance are expressed as: (BTU)/(h) (sq. ft.) (F)
- Thermal Transmittance applies to an actual total-material assembly, and as such is a quantitative physical property that can be used to represent the overall thermal performance of a system
- Thermal Resistance – The number of degrees difference between two surfaces (energy difference) that is required to obtain an energy flow of 1 BTU through a 1-square-foot sample of a given material thickness in one hour
- The R-Value is the reciprocal of the C-Value
- Units of Thermal Resistance are expressed as: (F) (sq. ft.) (h)/(BTU)
- Thermal Resistance applies to an actual thickness of a material, and as such is a quantitative physical property that can be used for determining insulation requirements
- Refer to the current Model Energy Code and local/state energy codes for minimum roof insulation R-Values required in specific geographic locations

The determination of potential energy savings based upon different types and thicknesses of roof insulation is a relatively complicated analysis that is beyond the scope of this Manual. The following is a general description of commonly used references and tools:

The NRCA Energy Wise Roof Calculator

Generalized Analysis

- Provides a simplified method for determining the amount of insulation necessary to construct an energy-efficient low-slope roof system.
- Provides a simplified method for determining the energy cost savings resulting from the installation of additional roof insulation.
- Suitable for most roofing-related energy evaluations.
- Go to www.energywise.nrca.net

DOE Energy Calculator

- Go to www.ornl.gov/sci/roofs+walls/facts/CoolCalcEnergy.htm to find the Cool Roof Calculator
- This tool measures the energy savings for low-slope roofs with non-black roof surfaces.

Roof Drainage

Why Roofs Should Drain

- Standing water can result in deck deflection and possible structural damage
- Water on the roof can promote vegetation, fungi, and bacterial growth
- In the event of an opening in the roof membrane, standing water can significantly worsen damage to the roof system, the building itself, and interior contents by providing a reservoir of water ready to gravitate through the membrane opening
- Required by model building code
- To prevent premature deterioration of roof membrane and flashing assemblies

How to Obtain or Improve Drainage

- Provide structural slope in the deck assembly
- Install a tapered insulation system (for recommendations on tapered roof insulation to provide slope for drainage, contact the GAF Technical Hotline at: 1-800-766-3411)
- Install tapered lightweight insulating concrete
- Add additional drains
- Use crickets, saddles, and sumped drains

Drainage Requirements

- Proper and adequate drainage is required and is the responsibility of those involved in the design and construction of the roof substrate and supporting structure. GAF recommends at least 1/4:12 slope with proper grading to and placement of outlets. Guarantees do not cover leaks or damages in areas of a roof that pond water. GAF defines “ponding” as water that does not drain or dissipate from the roof surface within 48 hours after precipitation ends. Ponding can also result from other water sources, including improperly piped air-conditioning condensate and steam condensate lines.

About Roof Drains

- A roof will drain free of water only as rapidly as drains and leaders will allow. When interior roof drains are used, they should be properly located and sufficient in number and size to drain all accumulated water from the surface of the roof in accordance with the local code. Special consideration should be given to the location of the drains and/or scuppers and gutters to ensure their usefulness when deflection of the decking may reasonably be expected to occur after its installation.
- Roof drains designed to lengthen the period of drainage by metering the flow of water to storm sewers and constructing drainage of the roof in conformance with certain codes are at best **hazardous** to the overall performance of a roofing system. Anything that reduces good, immediate drainage of a roof presents a hazard.

- The size and locations of drains will vary with the slope of the deck, the roof surface (smooth or gravel), and the intensity of the possible maximum rainfall in the areas in which the building is to be erected. Many roof problems can be traced to improper spacing of drains, insufficient size of drains and leaders, inadequate gutter and valley drainage, and lack of scuppers and overflow drains.
- Drains should be appropriate size to allow for rapid removal of water according to local codes, maximum expected rainfall, and ANSI requirements.
- Always recess drain heads below roof surface level to allow immediate water runoff. Drains and drain flashing shall be set a minimum of 1" (25 mm) below the roof level and located at least 18" (457 mm) away from all walls. Where the building has parapet walls, it is often necessary to form crickets with a definite high point between proposed drains and a definite low point at the drain location. Tapered insulation should be used at all drain edges to sump drains.
- Drains should not be less than 3" (76 mm) in diameter. When the location of drains has been determined, the actual roof areas draining to each outlet should be computed.
- Drains should be located to avoid forcing water to flow beyond a sharp turn. Intermediate drains should be located at not over 75' (22.9 m) to 50' (15.2 m) intervals for steep roofs.
- Outlets should always be provided with suitable strainers to prevent debris from clogging the outlet or leader. Strainers should be made of a corrosion-resistant material.
- Leaders: The cross-sectional area of a leader should be uniform for its entire length. Tapered leaders may cause choking or backing up of water flow. The cross-sectional area of the leader should be no less than the cross-sectional area of the drain outlet.
- Provisions should be made to prevent leaders from freezing below the roof line.
- Overflows are a safety factor and should be installed above every drain/scupper. When they are eliminated to satisfy architectural requirements, if allowable by local building codes, adequate provisions should be made to increase the size of the drains and leaders. Overflows should be installed in accordance with local building codes and below the counterflashing.
- Gutters should be larger, never smaller, than the leader. When leaders are spaced more than 50' (15.2 m) apart, the size of the gutter should be increased 1" (25 mm) for every additional 20' (6.1 m) between leaders. When leaders are spaced less than 50' (15.2 m) apart, a gutter the same size as the leader can be used providing the leader is not less than 4" (102 mm).
- The outside edge of the gutter should be at least 3/4" (19 mm) lower than the roof level or eave so that water will not back up or stand on the roof in case the leader becomes clogged.

Additional Roof Drainage Factors

- Uncontrolled roof drainage at the perimeter, over the roof edge, can lead to damage and discoloration of the exterior building wall.
- Control roof drainage within individual roof areas to accommodate drainage flow. Provide overflow drains or scuppers for all enclosed roof areas.
- Control roof drainage from higher roof levels by collecting drainage from drip-edge conditions in gutters. This allows redirection of drainage toward drain points of lower roof levels. Install splash blocks beneath all downspouts.

Expansion Joints

The function of an expansion joint is to minimize the effect of stresses and movements of building components and to prevent these stresses from adversely affecting the building.

Where to Use Expansion Joints

- The design, location, and use of building expansion joints **must** be considered at the time of original building design and are the responsibility of the architect, engineer, and owner.
- Although requirements may vary depending on structural and climatic conditions, expansion joints are strongly recommended:
 - Every 200 lineal feet (61 m) of building length
 - Where steel framing, structural steel, or deck materials change direction or elevation
 - Where separate wings of "L," "U," "T," or similar configurations exist
 - Where the type of deck material changes, i.e., where precast concrete and steel decks abut
 - Within the roofing system whenever control, expansion, or contraction joints are provided in the deck material or deck system
 - Where additions are connected to existing buildings
 - At junctions of canopies, exposed overhangs, or loading docks

Expansion Joint Requirements

- Must be continuous along the break in the structure and not terminated short of the end of the roof deck
- Should never be bridged with insulation or roofing membrane
- Construction ties must be removed in order for expansion joints to function properly
- Extend expansion joints at least 8" (203 mm) above the roof surface on curbs and use either Metalastic® flexible expansion-joint covers or metal caps or covers
- Locate expansion joints so that normal drainage-flow patterns are not blocked; joints can also be positioned at the high points of the roof so that drainage is away from them
- Where possible, position walkways and roof-access points to limit roof traffic over expansion joints; provide protective coverings for expansion joints at locations of repeated roof traffic
- Area dividers or "control" joints are not considered expansion joints; they can be installed where expansion joints have not been provided for in the original building design or where stresses have developed in the roof system (contact our Helpline for recommendations regarding area dividers)

Roof Decks

GAF does not manufacture or install structural roof decks. Acceptance of the deck for application of the roof system is the responsibility of the architect and/or designer. Acceptance of a roof deck by GAF as satisfactory to receive roof materials only refers to the top deck surface.

The minimum roof-deck requirements that follow are provided as supplementary guides for the roof designer and erector; new or unusual decks not included in this Manual must be approved in writing by GAF Technical Services in order to be eligible for a roofing system to receive a GAF guarantee.

Design and Construction Considerations

- Must be adequately smooth and level to provide support and maximum contact surface for roofing materials.
- Must be dry (free of moisture in any form), clean, and free of debris, sharp projections, and depressions. All depressions, holes, deformations, etc., shall be made smooth prior to application of roofing materials.
- Must be constructed in accordance with the deck manufacturer's requirements and specifications by a qualified/certified deck installer.
- Do not install electrical conduit or piping immediately above or on the roof deck; roof systems cannot be properly installed on or over these types of items and, when hidden, they can be a future safety hazard.
- Must support maximum loads that may be imposed during and after construction; maximum deflection should not exceed 1/240th of the span at midspan.
- Must provide positive drainage unless other provisions are planned; see section on drainage.
- On slopes $1/2:12$ or greater ($3/4:12$ or greater for torch-applied systems), provisions must be made for insulation stops and/or back-nailing of the membrane.
- Must be designed to accommodate structural expansion and contraction; see section on expansion joints.
- Must be designed in accordance with insurance and code requirements.
- Do not use the space directly below the deck as a plenum without enclosing the conditioned or return air in ducts. If, because of design considerations, the bottom of the deck is to be used as a plenum, contact GAF Technical Services for further recommendations.
- GAF shall not be responsible for damage to the roofing system caused by moisture entrapment under the roofing system from the deck or any other source.

Steel Decks

- Should have a G-90 galvanized finish on all panels.
- Can be categorized into 3 configurations:
 - 1) narrow rib, 1" (25 mm) flute opening or smaller
 - 2) intermediate rib, 1" - 1 3/4" (25 mm - 44 mm) flute opening
 - 3) wide rib, 1 3/4" - 2 1/2" (44 mm - 64 mm) flute opening
- Must be a minimum uncoated-thickness of 22 gauge (0.8 mm).
- Must comply with the gauge and span requirements in the current Factory Mutual FM Approval Guide and be installed in accordance with Loss Prevention Data Sheet 1-28 or specific FM approval.
- Wood nailers of equivalent thickness to the roof insulation must be provided at open perimeters and projection openings to act as an insulation stop and to provide for the nailing of the flanges of metal flashing.
- Insulation boards thick enough to span the flutes of the steel deck as recommended by the insulation manufacturer are required and must be secured to the steel deck with approved Drill-Tec™ Mechanical Fasteners to meet at least an FM 1-60 uplift resistance rating. Insulation should be installed over steel decks with long sides continuous, either parallel or at right angles to steel deck ribs. The board edges that are parallel with the steel deck ribs must rest firmly on the bearing surface of the steel deck. The joints of parallel courses of insulation should be staggered.

- When two layers of insulation are to be installed, solidly mop the second layer of insulation to the first layer. As an alternate to asphalt, both layers of insulation can be mechanically fastened simultaneously.
- When reroofing over steel decks, surface corrosion shall be removed, repairs to holes or severely corroded areas made, loose or inadequately secured decking shall be fastened, and irreparable or otherwise defective decking shall be replaced.

Loadmaster™ Decks

GAF offers a unique single-source Platinum Promise Guarantee for approved installations over Loadmaster™ Composite Steel Roof Decks. This guarantee covers both the installed GAF roofing membrane and the underlying Loadmaster™ Roof Deck assembly. It is available for terms up to 20 years for selected premium specifications.

Installations over Loadmaster™ roof decks must conform to the following minimum requirements:

- Roof deck must be installed by a Loadmaster™-approved contractor according to Loadmaster's specifications.
- The metal deck used in the Loadmaster™ system must be no lighter than 25-gauge.
- RUBEROID® SBS hot-applied and GAFGLAS® built-up roofing systems are acceptable for use over Loadmaster™ roof decks.
- Selected GAF roof system must be finished with a light-colored surface. White granular-surfaced membranes, light-colored gravel surfacing, and approved light-colored Matrix™ or TOPCOAT® protective coatings are acceptable for use over Loadmaster™ roof decks.

Poured Structural Concrete Decks

- Poured-in-place structural concrete decks consist of Portland cement, water, and aggregate.
- These decks typically vary from 4" to 12" (102 mm to 305 mm) in thickness.
- Must be poured over removable forms or must provide for bottom-side drying. Poured-in-place structural concrete decks that are poured over non-vented metal decks or pans that remain in place can trap moisture in the deck under the roof system and are not acceptable.
- The underside of the concrete decks, either the vented metal forms or exposed concrete, must remain unobstructed to allow the escape of water vapor. Materials that retard the flow of vapor must not be installed directly below the deck. Foil-faced insulation secured to the bottom of the deck, spray-on fireproofing, or paint that obstructs the venting of the concrete are just three examples of the unacceptable deck assemblies.
- It is the responsibility of the engineer, architect, building owner, or the roofing contractor to determine the fitness of a deck for direct membrane application to a concrete deck.
- Treat cracks greater than 1/8" (3 mm) in width in accordance with the deck manufacturer's recommendations.
- Must be properly cured prior to application of the roofing system; twenty-eight (28) days is normally required for proper curing. Curing agents must be checked for compatibility with roofing materials. Prior to the installation of the roof assemblies, GAF recommends the evaluation of the surface moisture and deck's dryness through the use of ASTM D4263 or hot bitumen test.
- Cannot be wet or frozen. If the deck is determined to be wet, it must be allowed to dry.
- Sumps for the roof drains should be provided in the casting of the deck.
- For insulated decks, wood nailers of equivalent thickness to the roof insulation must be provided at open perimeters and projection openings to act as an insulation stop and to provide for the nailing of the flanges of metal flashing.
- For non-insulated decks, nailers must be flush with deck surfaces.
- When applying roofing or insulation directly to the deck with asphalt, prime with Matrix™ 307 Premium Asphalt Primer, ASTM D41, at a rate of 1 gal/square (0.4 L/m²) and allow the primer to dry prior to the application of the roofing system.

Precast Concrete Decks

- Decks with broomed or textured surfaces are not acceptable for direct application of a non-insulated roofing system.
- Precast concrete decks are usually manufactured as planks or slabs and constructed of steel-reinforced Portland cement and solid aggregate; often they are made with hollow cores to minimize their weight.
- It is the responsibility of the engineer, architect, building owner, or the roofing contractor to determine the fitness of a deck for direct membrane application to a concrete deck.
- If the deck is determined to be wet, it must be allowed to dry.
- All deformed panels must be replaced.
- Joints must be filled with a masonry grout to correct imperfections between slabs and feathered to provide a slope not greater than $1/4:12$ for non-insulated assemblies or $1/8:12$ for insulated assemblies.
- Fill depressions with masonry grout and treat cracks greater than $1/8$ " (3 mm) width in accordance with the deck manufacturer's recommendations.
- If the joints cannot be grouted and finished smooth, then a leveling course of lightweight insulating concrete (minimum 2" [51 mm] thickness) must be applied. Do not seal joints between the slabs; leave open to permit venting and drying of roof fill from below.
- When applying roofing or insulation directly to the deck with asphalt, prime with Matrix™ 307 Premium Asphalt Primer, ASTM D41, at a rate of 1 gal/square (0.4 L/m²) and allow the primer to dry prior to the application of the roofing system. Hold back bitumen at the joints approximately 4" (102 mm) to prevent bitumen drippage.

Prestressed Concrete Decks

- GAF recommends a minimum 2" (51 mm) cellular lightweight concrete fill be installed over all prestressed concrete decks prior to installation of the roof system and/or insulation because variations in camber and thickness of prestressed concrete members may make securement of the roof system difficult.
- It is the responsibility of the engineer, architect, building owner, or the roofing contractor to determine the fitness of a deck for direct membrane application to a concrete deck.
- If the deck is wet, it must be allowed to dry.
- Lightweight fills can also be poured to provide slope in the deck to facilitate drainage.
- The 2" (51 mm) minimum-fill thickness at low points allows for mechanical attachment of the base sheet to the deck.
- Provisions must be made for the curing or drying of the fill installed over the top of the prestressed deck members.

Poured Gypsum Decks

- Gypsum concrete decks are formed by pouring gypsum concrete over reinforcing galvanized steel mesh. Formboards are left exposed or a rated finished ceiling is suspended below. Poured-in-place gypsum concrete slabs dry out and cure from the underside and adequate heat and ventilation below the slab are needed to permit the escape of moisture.
- Generally, the poured gypsum decks encountered are existing decks; contact our Technical Helpline for recommendations regarding roofing over newly installed poured gypsum decks.
- Must be smooth and free from deflections or ridges.
- An average fastener withdrawal resistance as recommended by the fastener manufacturer must be obtained; however, at no time should the withdrawal be less than 40 lbs. (178 N) per fastener.
- If surface is either wet or frozen, a poured gypsum deck is not suitable to receive a roof.
- GAF will not be responsible for splits in a GAF membrane that are caused by cracking of the gypsum deck, regardless of the cause.

- When reroofing over old, dry, poured gypsum decks, a GAFGLAS® #75 Base Sheet may be used in lieu of the GAFGLAS® Stratavent® Nailable Venting Base Sheet.
- If proper mechanical attachment cannot be achieved, please contact our Technical Helpline for assistance with installation recommendations.

Lightweight Insulating Poured-in-Place Concrete Decks (LWIC)

- Lightweight aggregate insulating concrete roof decks are poured in place in a slurry comprised of Portland cement, perlite or vermiculite aggregate, and water. Cellular concrete is comprised of Portland cement, water, and a preformed foaming agent that produces a closed cell network throughout the concrete.
- Individual concrete deck manufacturers may incorporate polystyrene insulation boards into the deck design to provide additional slope and/or insulating value to the completed deck system.
- Lightweight insulating concrete decks are required to have a minimum thickness of 2" (51 mm), a minimum compressive strength of 125 psi (87,900 kg/m²), and a density of 22 psf (352 kg/m²). Individual deck manufacturer's standards apply when their specifications exceed these GAF minimum thickness, compressive strength, and density requirements.
- Where the January mean temperature (reference current ASHRAE Fundamentals Handbook) is below 40°F (4.4°C), lightweight insulating concrete decks must be poured and roofed between April 1 and October 31; this type of deck is unacceptable in Alaska.
- The lightweight insulating deck/fill must be installed by an applicator approved, in writing, by the deck manufacturer.
- The roof system shall be installed as soon as possible following deck curing to prevent damage from exposure to precipitation; the maximum drying time before installation of the roof system shall be the maximum time required by the deck manufacturer.
- LWIC should not be poured during rainy periods; deck areas that have frozen before they have cured must be removed and replaced. Decks that receive precipitation prior to installation of the roof membrane must be checked for moisture content and dryness.
- Aggregate-based lightweight insulating concrete decks require bottom-side venting as rovided. Solid metal decking and structural concrete decks are among those not acceptable to receive an aggregate-based lightweight insulating concrete mix.
- Cellular lightweight insulating concrete decks can be installed over non-slotted, or slotted, galvanized metal decking designed for cellular LWIC or over structural concrete.
- Topside- or perimeter-venting is required. Use one-way pressure release vents with all specifications installed over these decks at a rate of one vent for each 10 squares (1,000 ft²) (92.90 m²).
- On new lightweight insulating concrete decks, use a GAFGLAS® Stratavent® Nailable Venting Base Sheet as the base sheet. It is also required for all twelve-, fifteen-, and twenty-year guarantee specifications. Over dry, old decks with less than 10% moisture content, GAFGLAS® #75 Base Sheet may be used as the base sheet for five- and ten-year specifications.
- Mechanically attach the GAFGLAS® Base Sheet using the Drill-Tec™ Base Sheet Fastener. Using Plates with the Drill-Tec™ Base Sheet Fastener, nail the two-inch (51 mm) side lap on 9" (229 mm) centers; in the field of the sheet, stagger nail on 18" (457 mm) centers, in two rows located approximately 12" (305 mm) from each sheet edge. This is **not** a FM-Approved installation pattern. Refer to the current FM-Approved Guide for formally approved systems.
- Lightweight insulating concrete decks are acceptable only on slopes up to 1:12.
- Do not attach insulation directly to lightweight concrete decks. Over old, dry decks, additional board insulation may be solidly mopped to an approved mechanically attached base sheet.
- GAF requires a minimum 40 lb (178 N) withdrawal resistance for Drill-Tec™ CR Base Sheet Fasteners installed into lightweight insulating concrete decks.

Wood Decks—Plank and Heavy Timber

- Wood boards must be at least 1" (25 mm) nominal thickness and have a nominal width of 4"- 6" (102 mm -152 mm). Tongue-and-groove or shiplap lumber is preferred to square edge material since subsequent shrinkage or warping of square edge planks may cause ridging of the roof system above adjacent boards.
- All boards must have a bearing on rafters at each end and be securely nailed.

Wood Decks— Plywood

- Lumber should be kiln-dried.
- Preservatives or fire retardants used to treat decking must be compatible with roofing materials.
- Decking should be kept dry and roofed promptly after installation.
- Knotholes or large cracks in excess of $\frac{1}{4}$ " (6 mm) should be covered with securely nailed sheet metal.
- When light metal wall ties or other structural metal are exposed on top of the wood deck, cover them with a heavy ply of a roofing sheet, such as GAFGLAS® Stratavent® Nailable Venting Base Sheet, extending 2" - 6" (51 mm - 152 mm) beyond the metal in all directions. Nail in place before applying the base ply.
- Attach an acceptable base sheet through flat metal caps or use nails with attached 1" (25 mm) square or round metal caps that have a minimum withdrawal resistance of 40 pounds each (178 N).
- Tape and staple-fastening systems may be used on wood decks when they comply with local building codes and agencies.

- Plywood sheathing shall be exterior-grade, minimum 4-ply, not less than $\frac{15}{32}$ " (12 mm) thick.
- Preservatives or fire retardants used to treat decking must be compatible with roofing materials.
- Must be installed over joists not greater than 24" (610 mm) o.c.
- Must be installed so that all four sides of each plywood panel bear on and are secured to joists and cross blocking; the plywood must be secured in accordance with the Engineered Wood Association recommendations. "H" clips are not acceptable.
- Panels must be installed with a $\frac{1}{8}$ " to $\frac{1}{4}$ " (3 mm - 6 mm) gap between panels and must match vertically at joints to within $\frac{1}{8}$ " (3 mm).
- Decking should be kept dry and roofed promptly after installation.
- Knotholes or large cracks in excess of $\frac{1}{4}$ " (6 mm) should be covered with securely nailed sheet metal.
- When light metal wall ties or other structural metal are exposed on top of the wood deck, cover them with a heavy ply of roofing sheet, such as GAFGLAS® Stratavent® Nailable Venting Base Sheet, extending 2" - 6" (51 mm - 152 mm) beyond the metal in all directions. Nail in place before applying the base ply.
- Attach an acceptable base sheet through flat metal caps or use nails with attached 1" (25 mm) square or round metal caps that have a minimum withdrawal resistance of 40 pounds (178 N) each.
- Tape and staple-fastening systems may be used on wood decks when they comply with local building codes and agencies.

Oriented Strand Board (OSB) Decks

- Only products with the Structural 1 APA rating should be used as a decking material.
- Weyerhaeuser's Struc-One oriented strand board is an acceptable substrate to receive a GAF roofing assembly. It must be a minimum of $\frac{1}{2}$ " (13 mm) thick. See plywood deck section for applicable requirements.

Cementitious Structural Wood Fiber Decks

- Cementitious structural wood-fiber decks are manufactured from wood fibers bonded together with cementitious binders.
- Must be protected from the weather during storage and application; any decking that becomes wet or is deformed should be removed and replaced with new decking.
- Should not be installed over high-humidity occupancies.
- Must have a minimum design load as recommended by the deck manufacturer.
- All structural wood-fiber deck panels must be anchored against uplift and lateral movement.
- Install a mechanically attached base sheet prior to installation of insulation or roofing membranes; an average fastener withdrawal resistance as recommended by the fastener manufacturer must be obtained.

- Installation of fill material such as lightweight insulating concrete over these decks is acceptable only when installed in accordance with the lightweight deck manufacturer's recommendations and a deck certification from the manufacturer is issued.

Asphalt/Perlite Fill Decks

- Generally these decks are not considered a suitable substrate. Please contact our Technical Helpline for information on this type of deck.

Parapet Walls

Most common wall types are suitable substrates for the installation of GAF membrane flashing.

Brick/Block Masonry

- Standard-finish brick and concrete block with standard-tooled mortar joints.
- Split-face block, textured block and brick, and deeply tooled mortar joints require a cementitious parge coating to provide a smooth and even substrate surface.

Structural Concrete

- Steel trowel, wood float, or removable form finish.
- Ridges and other irregularities require grinding to provide a smooth and even substrate surface.

Stucco/ Exterior Finish Insulating System (EFIS)

- Stucco finish and EFIS systems are not acceptable substrates.

Plywood

- Minimum 4-ply, $1\frac{5}{32}$ " (12 mm) thickness, exterior grade.
- Tongue-and-groove edges or full blocking required.

Orient Strand Board (OSB)

- Minimum $\frac{1}{2}$ " (13 mm) exterior grade.
- Tongue-and-groove edges or full blocking required.

Sheet Metal

- Minimum 24-gauge steel or 0.032" (0.8 mm) aluminum.
- Corrugated panels require an overlay of $1\frac{5}{32}$ " (12 mm) plywood, or moisture-resistant gypsum panels.

Gypsum Panel

- Minimum $\frac{1}{2}$ " (13 mm) thickness.
- Moisture-resistant gypsum panels.
- Underlying substrate must allow securement of flashing at prescribed spacing.

Water Vapor Transfer

For projects where there is a significant difference in vapor pressure between building interior and exterior, the volume of water vapor flow is much greater, and control of water vapor transfer into and through a roof system becomes an important consideration. Without adequate control provisions such as a vapor retarder, the roof insulation can become saturated with water, with a corresponding reduction in insulation thermal performance. Structural deck damage and/or condensation into the building interior may also occur.

Vapor flow is referenced in various ways. The following are common terminologies:

Permeance

- The time rate of vapor transmission through a flat material or construction induced by vapor pressure difference between two specific surfaces, under specified temperature and humidity conditions.
- Units of permeance are expressed as: (gr)/(h) (sq. ft.) (in. Hg).

- The permeance, or perm rating, of a material is a performance evaluation specific to a sample of material, and not a specific property of the material.
- In general, the perm rating of a vapor retarder should be < 0.5 perms.

Relative Humidity

- Relative humidity is the ratio of the pressure of water vapor present in air to the pressure of fully saturated water vapor at the same temperature.
- Relative humidity is expressed as a percentage.

Dew Point Temperature

- The temperature at which air becomes saturated with water vapor (100 percent relative humidity) and condensation begins to occur.
- Dew point temperature is expressed as degrees F or C.

Temperature and Relative Humidity

A number of basic considerations factor into the need and location of a vapor retarder:

- Vapor flows based upon a difference in vapor pressure between two locations, and flows from higher to lower pressure regions.
- Normally, the higher the temperature, the higher the vapor pressure.
- In determining the need for a vapor retarder for most typical conditions, the exterior winter temperature and the interior winter relative humidity are the most critical factors.
- Temperature information is readily available from the National Weather Service.
- Relative humidity information is typically available from the building HVAC design professional or the building operations manager. Relative humidity can also be field-measured.

Vapor Retarder Location

- Vapor retarders are intended to be installed as close to the warm side of the roof assembly as possible. Normally, this places the vapor retarder directly on the structural deck or directly over a minimal layer of insulation. Note: the vapor retarder is **not** considered a part of the GAF roofing system.
- A sufficient amount of insulation must be installed over the vapor retarder so as to raise the dew point location above the level of the vapor retarder.
- Determining the need and location of the vapor retarder is the responsibility of the design professional.

Sealing Perimeter and Penetrations

- Vapor retarders shall be completely sealed at all perimeter and penetration locations.
- Sealing methods shall be selected in accordance with type of vapor retarder being installed.
- Air leakage into the roof system at perimeter and penetrations will significantly reduce the effectiveness of the vapor retarder by allowing moist air to penetrate into the roof assembly, where it can condense and cause roof deterioration.

Building Usage

- Normal building usage such as offices, schools, retail, warehousing, etc., will not normally require the use of a vapor retarder except when located in the most northern climates.
- Building usage such as swimming pools, food processing, paper manufacturing, foundries, etc., that result in increased internal temperatures and humidity conditions will likely require the use of a vapor retarder except when located in the most southern climates.
- These generalizations are not intended to substitute for actual vapor flow calculations based upon specific building and climatic conditions.

The Case For the Use of a Vapor Retarder

- A vapor retarder can protect the long-term thermal resistance of insulation sandwiched between the vapor retarder and the membrane.
- A vapor retarder provides a good safeguard against vapor migration in case a building's use changes from a "dry" use to a "wet" use.

The Case Against the Use of a Vapor Retarder

- The vapor retarder, together with the roofing membrane, may seal within the roof sandwich entrapped moisture that can eventually destroy the insulation, help split or wrinkle the membrane, or, in gaseous form, blister it.
- In the event of a roof leak through the membrane, the vapor retarder will trap the water in the insulation and release it through punctures, breaks, or poor seals in the vapor retarder that may be some lateral distance from the roof leak, thus making leak discovery more difficult. A large area of insulation may be saturated before the punctured roof membrane can be repaired.
- A vapor retarder is a disadvantage in summer, when vapor migration is generally downward through the roof (hot, humid air can infiltrate the roofing sandwich through the vents, or through diffusion through the roof membrane; it may condense on the vapor retarder itself).
- A vapor retarder may be the weakest horizontal shear plane in the roofing sandwich. Failure at the vapor retarder/insulation interface can result in splitting of the membrane. At the least, the vapor retarder introduces an additional component whose shear resistance may be critical to the membrane's integrity.

Insulation

The function of roof insulation is to provide insulating value, and it has economic benefits: increased comfort, smaller heating/cooling equipment requirements, lower operating expenses, and a reduced consumption of expensive fuel supplies. Insulation must also provide a smooth, dry, clean, and firmly attached substrate to receive the roof membrane.

The selection of insulation type, thickness, and configuration is the responsibility of the architect, engineer, or owner. GAF reserves the right to accept or reject any roof insulation as an acceptable substrate for GAF roof systems. GAF EnergyGuard™ Insulation must be used in roofing systems to be guaranteed by GAF.

Attachment

- The positive attachment of insulation over the substrate to which it is installed is essential. Insulation shall be attached according to the requirements of the insulation manufacturer, trade associations, local codes, and insurance underwriting agencies.
- Consult the current Factory Mutual Approval Guide and Factory Mutual Loss Prevention Data Sheets 1-28 and 1-29 for information on insulation attachment requirements.
- Do not install insulation in hot asphalt directly to a steel deck. The first layer of insulation must be mechanically attached to a steel deck.
- Install insulation to wood or wood-fiber nailable decks by either mechanically fastening the insulation or by nailing a base ply to the deck, following nailing recommendations for base plies, and then installing insulation in a solid mopping of asphalt.
- On slopes of $\frac{1}{2}$:12 or greater, consult the insulation manufacturer for recommendations regarding the installation of insulation stops.
- GAF is not responsible for damage to roofing membranes or flashing from movement or wind uplift due to inadequate attachment of the roof insulation. It is the responsibility of the design professional to determine wind-uplift design forces and the means of attaching the roof system to resist those forces.
- The maximum board size for attachment with hot asphalt or insulation adhesive is 4' x 4' (1.22 m x 1.22 m).

General Requirements

- Insulation must be approved by Factory Mutual and Underwriters Laboratories and be manufactured in board form to be used as a roof insulation.
- The minimum allowable thickness of insulation is $\frac{1}{2}$ " (13 mm). Insulation must be able to withstand foot traffic without crushing. When installed over a metal deck, the insulation must be strong enough to span the flutes without breaking under typical rooftop traffic conditions.
- The maximum allowable thickness for a single layer of insulation is 3" (76 mm) unless approved in writing by GAF.
- Multi-layer insulation assemblies simultaneously attached with approved mechanical fasteners must NOT exceed 5" (127 mm) in total thickness without prior written approval from GAF. When insulation is installed in two or more layers, the joints MUST be staggered.
- Do not torch membranes directly to insulations other than DensDeck® Prime or SECUROCK® roof boards.

Types of Insulation

The following insulations are acceptable for use in RUBEROID® SBS Heat-Welded Roofing Systems to be guaranteed by GAF.

Perlite

(ASTM C728/FS HH-1-529)

- EnergyGuard™ Perlite Roof Insulation
- EnergyGuard™ Re-cover Board
- EnergyGuard™ Tapered Roof Insulation Systems
- EnergyGuard™ Tapered Edge Strip
- EnergyGuard™ Cant Strip

Fiber Board

(ASTM C208/FS LLL-1-535b, Class C)

- EnergyGuard™ High Density Fiber Board Insulation
- EnergyGuard™ Regular Fiber Board Insulation

Polyisocyanurate

(ASTM C1289/FS HH-1-972, Class 1 Type II)

- EnergyGuard™ Ultra Polyiso Insulation
- EnergyGuard™ Polyiso Insulation
- EnergyGuard™ Tapered Polyiso Insulation

EnergyGuard™ HD + HD Plus Cover Board

(ASTM C1289/FS HH-1-972 Class 4 Type II)

GAF roof systems installed over polyisocyanurate roof insulations must utilize one of the following options as detailed by the specific specification:

- Utilize a GAFGLAS® Stratavent® Perforated Venting Base Sheet specification.
- Utilize a base ply of GAFGLAS® #75 Base Sheet mechanically fastened simultaneously with the insulation.
- Include an overlay board installed between the polyisocyanurate insulation and roof membrane consisting of a minimum 1/2" (13 mm) of perlite, fiber board, other approved insulations, or minimum 1/4" (6 mm) DensDeck® roof board.

EnergyGuard™ Composite Board Polyiso Insulation

EnergyGuard™ Tapered Composite Board Insulation

(FS HH-1-1972, Gen./FS HH-1-1972, 3)

Note: EnergyGuard™ Composite Board is manufactured in various areas that consists of isocyanurate foam core bonded to High Density Fiberboard, DensDeck® EnergyGuard™ perlite top layer.

USG SECUROCK® Roof Board

SECUROCK® roof board is available in 1/4" (6 mm), 3/8" (9 mm), and 5/8" (16 mm) thicknesses. It can be used as a fire barrier, an overlay board, or as a re-cover board in hot-applied BUR/MB, cold-applied MB, torch-applied MB, and self-adhered MB GAF roof systems.

DensDeck® and DensDeck® Prime Roof Boards

(ASTM C1177)

DensDeck® and DensDeck® Prime roof boards sold and distributed by GAF are acceptable for use in various GAFGLAS® and RUBEROID® Roof Systems as overlay and re-cover boards. Refer to individual GAF Roof System specification sections for limitations on the use of these insulation materials. In general, use of DensDeck® roof boards must conform with the following guidelines:

Membrane/System Application	DensDeck®	DensDeck® Prime
Hot-Applied BUR/MB	Not Recommended ¹	Not Recommended ¹
Hot-Applied BUR/MB – Insulated roofs over vapor retarders or existing membranes	Not Recommended ²	Not Recommended ²
Cold-Applied BUR/MB	Not Acceptable	Acceptable
Cold-Applied BUR/MB – Insulated assembly over vapor retarder or existing membranes	Not Acceptable	Acceptable ³
Torch-Applied MB	Not Recommended ⁴	Acceptable ⁵
Self-Adhered MB	Not Recommended	Not Recommended

(See Notes on following page)

Other Types Of Insulation

Note 1: Requires base ply of GAFGLAS® Stratavent® Perforated Venting Base Sheet or GAFGLAS® Ply 4 Felt, laid singly as the base ply in selected roof assembly.

Note 2: Requires GAFGLAS® Stratavent® Perforated Venting Base Sheet as base ply in selected roof system.

Note 3: Insulation must be mechanically fastened or installed in GAF Low-Rise Foam Adhesive. As an option, insulation may be installed in hot asphalt with cold-applied membrane installed over a mechanically attached GAFGLAS® Stratavent® Nailable Venting Base Sheet or GAFGLAS® #75 Base Sheet.

Note 4: Requires installation of GAFGLAS® Stratavent® Nailable Venting Base Sheet or GAFGLAS® #75 Base Sheet mechanically fastened with Drill-Tec™ Fasteners and Plates. Base sheet may be simultaneously attached with insulation.

Note 5: Requires prior approval by GAF Technical Services. Contact the GAF Helpline for additional information and requirements at 1-800-766-3411.

The following types of roof insulations are also available in the roofing industry; however, not all of these insulations are acceptable for use in GAF RUBEROID® SBS Heat-Welded-guaranteed roof systems. When used, GAF assumes no responsibility for their performance.

Note: The use of any of the following insulations in roof systems to be guaranteed by GAF requires approval in writing by a GAF Field Services Area Manager prior to installation. They are not covered by the roof guarantee, however.

Perlite/Polyisocyanurate/Perlite Composite

(FS HH-1-1972, Gen./FS HH-1-1972, 3)

Cellular Foam Glass

(ASTM C552/FS HH-1-551E)

- Must have an overlay of a minimum of 1/2" (13 mm) of perlite or wood fiber, or 1/4" (6 mm) minimum DensDeck® or SECUROCK® roof board.

Glass Fiber Board

(ASTM C726/FS HH-1-526)

Expanded Polystyrene

(ASTM C578)

- Must be a minimum of 1.5 lb. (80 kg/m³) density. Requires an overlay of a minimum of 1/2" (13 mm) perlite or wood fiber, or 1/4" (6 mm) DensDeck® or SECUROCK® roof board be mechanically fastened prior to application of roof membrane. (Do not use under solvent-based, Cold-Adhesive Applied roof systems.)
- Overlay board must either have all joints taped prior to installation of the roofing membrane, or a layer of red rosin sheathing paper must be installed between the layers of insulation.

Perlite/Expanded Polystyrene Composite

(ASTM C728/FS HH-1-529)

(ASTM C578/FS HH-1-524C)

- The polystyrene must be a minimum of 1.5 lb. (80 kg/m³) density. (Do not use under solvent-based, Cold-Adhesive Applied roof systems.)
- All joints must be taped prior to installation of the roofing membrane.

Wood Fiber/Expanded Polystyrene Composite

(ASTM C208/FS LLL-1-535b, Class C)

(ASTM C578/FS HH-1-524C)

- The polystyrene must be a minimum of 1.5 lb. (80 kg/m³) density. (Do not use under solvent-based, Cold-Adhesive Applied roof systems.)
- All joints must be taped prior to installation of the roofing membrane.

Suggested Insulation Fastening Patterns for GAF EnergyGuard™ Insulations & Drill-Tec™ Fasteners

Fastener Placement for 2' x 4' (610 mm x 1.22 m) Boards

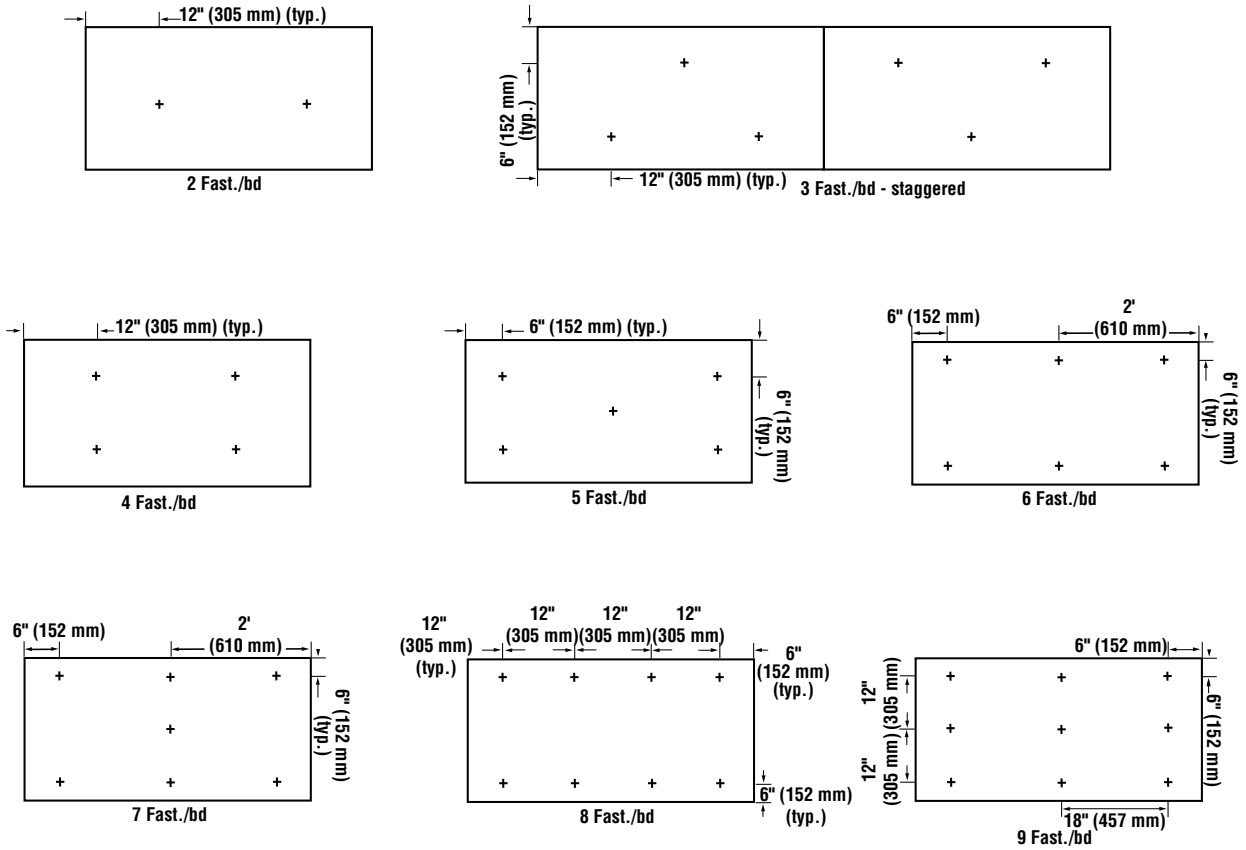

Fastener Placement for 4' x 4' (1.22 m x 1.22 m) Boards

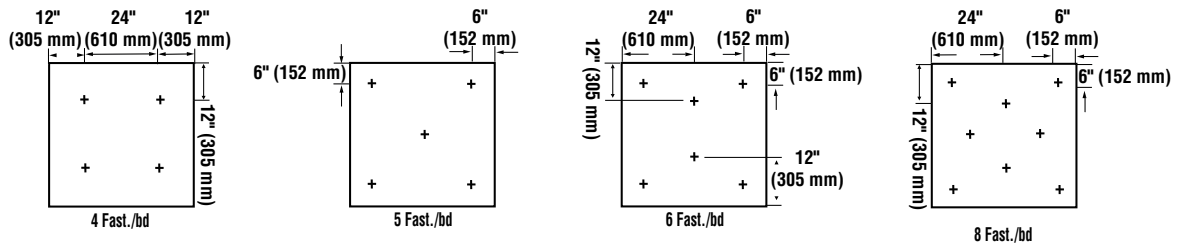

Suggested Insulation Fastening Patterns (continued)

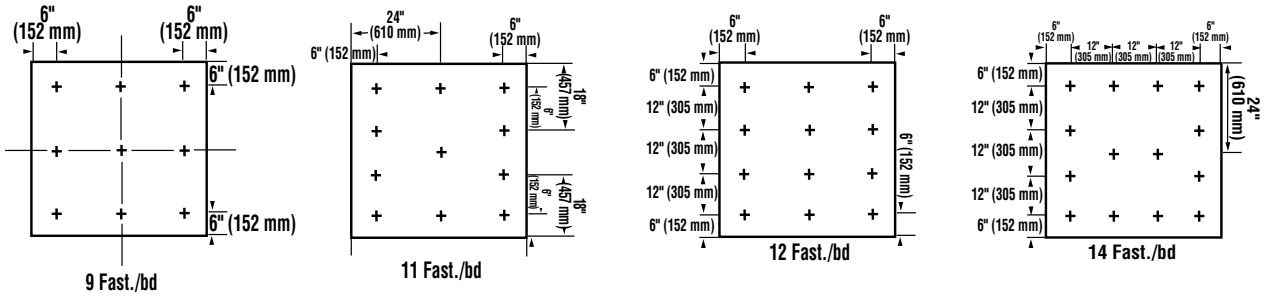

Fastener Placement for 4' x 8' (1.22 m x 2.44 m) Boards

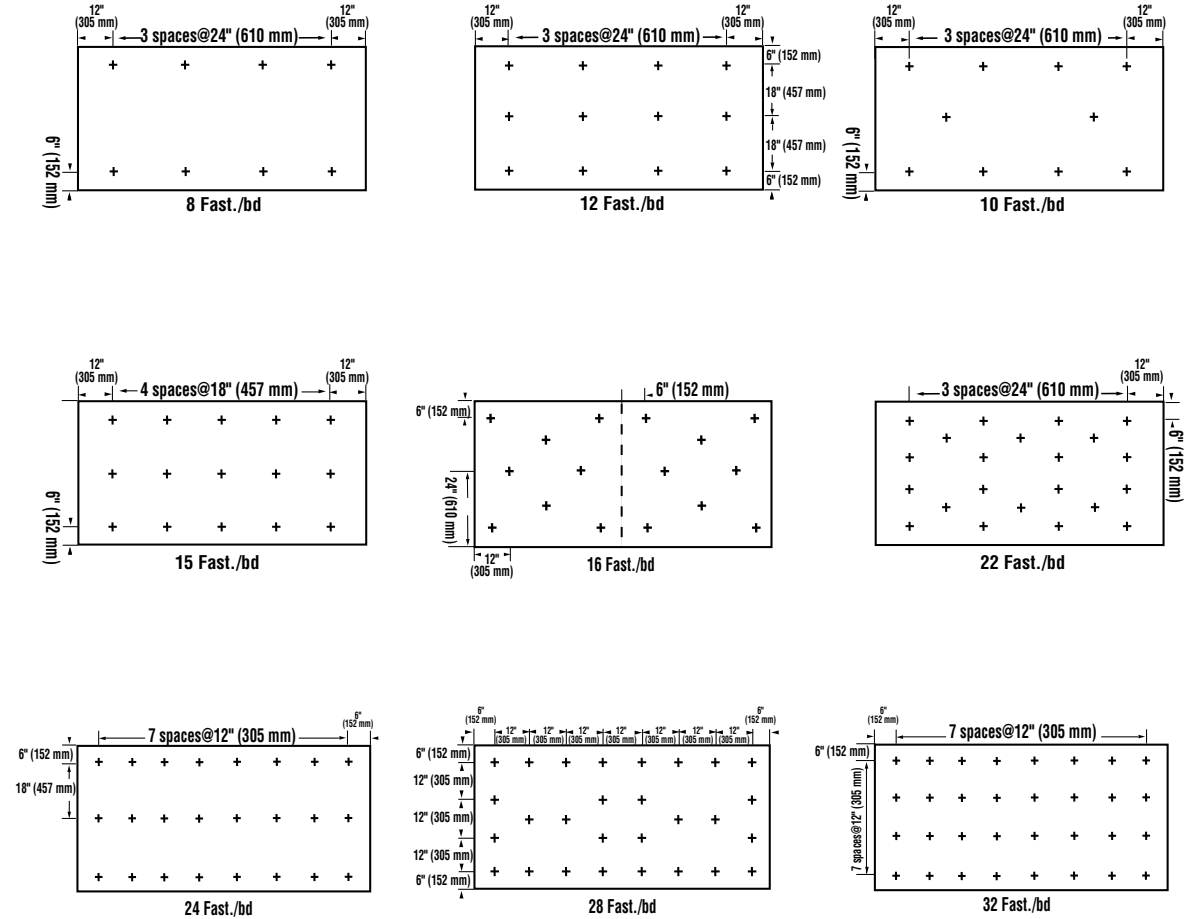

General Recommendations for Fastener Placement:

Follow all specifications and requirements for fastener selection, fastening density, general installation, and specific roof system and/or deck requirements as contained in this Manual. Drill-Tec™ or other GAF-approved Fasteners and Plates must be used in the construction of all GAFGLAS® and RUBEROID® roofing systems. The suggested insulation fastener placements shown above are based upon GAF approvals and the recommendations of FM Global Property Loss Prevention Data Sheet 1-29. For specific requirements related to Factory Mutual Insured roof systems, refer to FM Global approvals and applicable Loss Prevention Data Sheets for specific fastening requirements, including the need for increased fastener density at the roof corners and perimeters. For fastening densities not shown above, edge fasteners should be placed 6" (152 mm) from board edges with tolerances listed below. Remaining fasteners should be evenly distributed over the board area.

Recommended fastener embedment:

Steel deck: Fasteners should be driven through the deck-top flange and be of sufficient length to penetrate at least $\frac{3}{4}$ " (19 mm) through the deck. Fastener length should be a minimum of $\frac{3}{4}$ " (19 mm) longer than the roof assembly. For re-cover installations, fasteners may penetrate the bottom flange or flute of the deck but must take into consideration the thickness of the existing assembly as well as the depth of the deck flutes to ensure penetration at least $\frac{3}{4}$ " (19 mm) through the deck. Mechanically fastened roof covers require fastener placement through the deck-top flange.

Structural concrete: Install fasteners approximately 1" to 1½" (25 - 38 mm) into the deck.

Wood plank decks: Install fasteners a minimum 1" (25 mm) into the deck.

Plywood or approved OSB decks: Install fasteners a minimum of $\frac{1}{4}$ " (6 mm) through the underside of the deck.

Other deck types: Refer to the specific deck manufacturer's approval requirements and specifications.

Note: Fastener location tolerance is plus or minus 1½" (38 mm).

Asphalt

GAF systems require the use of ASTM D312, Type III or Type IV asphalt when used for the application of roof insulation, roof tape, base, ply, cap membranes, and surfaced aggregate for slopes as referenced below.

Specification and use of low softening-point bitumen increases the opportunity for bitumen drippage and membrane slippage. The designer and roofing contractor must take any necessary precautions to prevent damage to the structure or interior due to bitumen drippage.

Recommendations for Asphalt Types

Asphalt Type	Softening Point	Maximum Slope
ASTM D312, Type III	185-205°F (85-96°C)	up to 1/2:12
ASTM D312, Type IV	210-225°F (99-107°C)	up to 3:12

Equiviscous Temperature (EVT) Range. The temperature at which an asphalt achieves its optimum viscosity for application of a built-up roof is the equiviscous temperature. Asphalt at the point of application should be at the EVT +/- 25°F (±13.9°C). The EVT for each asphalt shipment should be requested from the asphalt manufacturer.

For SBS modified bitumen membranes installed with hot asphalt, the asphalt temperature at the point of application should be at its EVT or 425°F (218.3°C), whichever is greater.

The Finished Blowing Temperature (FBT) is the minimum temperature at which the blowing of the asphalt has been completed during its manufacture. Heating the asphalt for an extended period of time above this temperature can result in lowering the softening point of the asphalt as well as changing other characteristics of the asphalt.

Maximum Heating Temperature: In accordance with ASTM D312, the maximum heating temperature of any ASTM D312 asphalt is 550°F (260°C).

Surfacing

There are several types of surfacing used with RUBEROID® modified bitumen and GAFGLAS® built-up membranes:

- Factory-applied mineral granules.
- Flood coat and aggregate: use aggregate meeting ASTM D1863. The pour coat of asphalt should meet ASTM D312, Type III or IV. Aggregate that does not meet ASTM D1863 must be approved by GAF.
- For smooth-surface GAFGLAS® BUR (North and South Zones only), a squeegee-applied glaze coat of ASTM D312, Type I asphalt may be used on slopes up to 1/4:12 applied at the maximum rate of 15 lbs./sq. (.5 kg/m²)
- TOPCOAT® elastomeric coatings. A selection of these coatings are available with the ENERGY STAR® certification (U.S. only) and Title 24 compliance. These coatings are typically field applied or available as a factory applied surfacing.

Walkways

- Walkways for normal rooftop traffic can be constructed from one or more layers of RUBEROID® membrane. These types of walkways are not intended for plaza deck or patio-type use.
- For normal-to-moderate traffic conditions, torch-apply one layer of RUBEROID® Torch Granule or fully adhere one ply of RUBEROID® Mop Granule or RUBEROID® Mop Plus Granule FR in a solid mopping of asphalt or application of Matrix™ 102 SBS Membrane Adhesive. For gravel surfaced systems, install walkways over the completed field plies prior to application of final surfacing.
- For heavier traffic conditions such as around rooftop equipment, hatches, and doorways, a two-ply walkpad should be constructed from RUBEROID® membranes with the use of an additional layer of smooth-surface RUBEROID® Torch Smooth or RUBEROID® Mop Smooth 1.5 as the first ply in the respective walkpad assembly.
- Walkway sections should be no longer than 10' (3 m), with a 6" (152 mm) minimum gap between sections to allow for drainage.
- Surface the roof around and between the pads, making sure the selvage edge of the RUBEROID® membrane is covered or trimmed off.

Wood Nailers

GAF construction details are drawn to reflect typical industry uses of wood nailers at vertical penetrations such as walls or curbs, as insulation stops at ridges and perimeter edges, for attachment of metal flashings or accessories, and where required for interim back-nailing on steep-slope installations. Wood nailers may be used for insulation stops but are not required at "closed" vertical terminations such as equipment curbs, or along parapet walls where standard GAF wall-supported deck base flashing details are utilized.

Wood nailers are required at perimeter edges, ridges, vertical intersections, penetrations, and other flashings where any of the following conditions occur:

- Field-of-roof expansion joints
- Curb-to-wall or field-to-wall expansion joints
- Base flashings to non-wall-supported deck details
- Open terminations such as at perimeter metal edges, gutter edges, gravel stops, interior courtyards, etc.
- Field terminations, curbs, penetrations, or other flashings that require wood-blocking for support of vertical members or rooftop equipment
- Where metal-flanged flashings are installed into the roof system
- Steep-slope applications above 1/2:12 (interim nailers required)
- Where required by project designer, local code, or project insurance requirements for structural, wind, or other general design requirement

Lumber-industry conversions to new preservative treatments ACQ (alkaline copper quat) and CA (copper azole) have largely replaced CCA (chromated copper arsenate) treated lumber. These new treatments are believed to be significantly more corrosive to metals than previous treated woods, particularly when in the presence of moisture or high humidity, and could lead to premature fastener failure or deterioration of metal components incorporated into the roofing assembly.

Where nailers or wood-blocking are required, GAF recommends the use of only non-treated wood. If treated wood-blocking or nailers are required by project design, local code, or insurance carrier, use fasteners and separators as recommended by the designer, code, or insurance agency. GAF assumes no responsibility for corrosion problems resulting from the use of treated wood.

All wood nailers must be at least 3 1/2" (89 mm) wide and either mechanically fastened to the roof deck or structural members, or cast in place for poured roof decks. For insulated assemblies, nailers must be equal in thickness to the installed insulation and mechanically fastened to the roof deck. Interim nailers where required for steep-slope installations must be set perpendicular to roof slope.

Note: Wood nailers, and any leaks or damages in connection with them, are not covered by GAF guarantees.

Flashing

Flashing is used to waterproof the field of the roof anywhere it is interrupted, e.g., at walls, curbs, edges, penetrations, drains, etc., and the juncture of the field of the roof and vertical surfaces. Flashings are the most vulnerable moisture infiltration points on any roof.

- Wall flashing can be divided into two categories: non-wall-supported roof deck and wall-supported roof deck. Non-wall-supported roof deck design provides for differential movement between the wall and roof deck. The wall-supported roof deck design is structurally constructed without the anticipation of differential movement. GAF provides details for both situations.
- Isolate the structural deck, roofing system, and base flashing from vertical walls, projections, etc. This is best accomplished by the use of horizontal and vertical wood nailers installed at perimeters, projections, etc., and through the use of metal counterflashing to divert water over the base flashing.
- Ensure that water drains immediately away from all flashing.
- Minimum height of base flashing should be 8" (203 mm) above the roof-surface level and the maximum height should be 24" (610 mm) above the roof level. Wall coverings above the base flashing are not a part of the roofing system and are not included in GAF roofing system guarantees.
- Wood nailers should be installed at open perimeter edges and secured to the roof deck.
- Use approved GAF membranes and adhesives for base and wall flashings.
- When metal cap or counterflashing cannot be installed on the same day as the membrane base flashing, the top edge of all base flashings must be stripped in using flashing cement and glass fiber reinforcement. All stripped-in material must be removed prior to torch-welding of any membrane.
- "Through-wall" flashing should be used on all masonry walls. If "through-wall" flashing is not possible, masonry walls must be designed to prevent moisture infiltration.
- All base flashings must be mechanically fastened at the top edge of the flashing with 1" (25 mm) round or square metal cap nails or appropriate fastener on a maximum of 8" (203 mm) centers for flashings up to 12" (305 mm) in height and on 4" (102 mm) centers for flashings up to 24" (610 mm) in height. Termination bars may only be used in conjunction with proper counterflashing and the fastener spacing shall not exceed the above minimum requirements.
- Apply flashing details after the installation of the roofing membrane, but before the application of any surfacing materials.
- Avoid the use of pitch pans. Pitch pans are maintenance items that can easily become sources of leaks if not maintained or improperly used or installed.
- Due to the differential expansion between metal and asphalt, large metal flanges are undesirable surfaces to flash; such units should be mounted on canted wood curbs at least 8" (203 mm) above the level of the roof surface.
- Metal gravel-stop flanges must be primed, properly nailed to a wood nailer, and installed between a stripping ply of modified bitumen membrane and the field of the roof. Where metal gravel-stop flanges are flashed to the roof membrane, leaks caused by metal movement are not covered by GAF guarantees, and are the responsibility of the building owner.
- Piping and conduit should not run across the roof; where no alternative exists, the piping/conduit should be elevated at least 8" (203 mm) above the surface of the roof on properly flashed supports that are secured to the structural roof members. Lightweight piping/conduit less than 2" (51 mm) in diameter may be set on wood blocks with pads over the finished membrane.

Test Cuts

- There is no substitute for quality materials and workmanship. Should cuts for testing purposes be required, such cuts should be taken before the final surfacing is installed so that proper and adequate repairs can be accomplished.
- GAF will not comment on the results of any test cut that cannot be shown to be statistically representative of the roofing system.
- The party requesting the taking of test cuts from any GAF roof shall assume all responsibility for any detrimental effects of said test cuts.

Re-cover and Reroofing

Every reroofing project has its own unique design challenges that require individual assessment. GAF requires that a thorough investigation of the existing roof system and its support system must be made to determine the cause of roof system failure or deterioration. The determination of whether to tear-off or re-cover an existing roof system is the responsibility of the architect, engineer, or owner.

The decision to tear off and replace or to prepare and then re-cover an existing roofing system is not always clear-cut.

When installed in strict adherence to GAF requirements by a GAF Master or Master Select™ Roofing Contractor, Diamond Pledge™ or System Pledge™ guarantees up to 20 years are available for tear-off/replacement roofs depending on the specification selected.* Ten-year Diamond Pledge™ or System Pledge™ guarantees are available for re-cover roofs.* To qualify, re-covering a roof requires the use of a minimum RUBEROID® specification that incorporates a glass base sheet or, for GAFGLAS® BUR, a minimum 4-ply specification is required.*

GAF will not accept responsibility for damage of its roof systems in any way caused by re-covering an existing roof system.

* See applicable guarantees for complete coverage and restrictions.

Tear-Off/Replace **Factors that support the tear-off approach include:**

- Two or more existing roofs
- Structural weight limitations
- Over 25% of the existing roof area is wet
- Flashing height limitations
- Need to maximize long-term performance

The goal for any tear-off project is to provide a sound substrate for the installation of a new roofing system and correct existing design deficiencies. At a minimum, attention to the following considerations is recommended:

- Thoroughly inspect decking, flashing substrates, and wood nailers before installing new materials
- Plan tear-off strategy so that roof drainage patterns are never blocked and so that construction traffic is directed away from new roof areas
- Protect new roof areas adjacent to tear-off areas from dirt, debris, and damage

Re-cover

Factors that support the re-cover approach include:

- Need to minimize cost
- Preserve existing thermal roof insulation
- Disposal restrictions
- Difficult access to roof
- Only one roof in place

A re-cover should be considered only if the following items are addressed and preparation includes:

- Establishing the history of the old roof system and determining and correcting the cause of any premature roof failures.
- The existing roof system must be compatible with the proposed new roof assembly. Sprayed-in-place urethane foam roof systems are not eligible for re-cover. For re-cover installations over single-ply, fluid-applied, coal tar, and metal roofs, contact the GAF Helpline for prior approval and technical requirements.
- Determining that the deck is structurally sound to receive a new roof system.
- Taking test cuts to verify the existing roof construction and condition. Three test cuts should be made for roofs under 100 squares (929 m²) and one test cut per 100 squares (929 m²) above the minimum amount.
- All irregularities in the existing membrane and deck system can be and are repaired in order to make the membrane ready to receive the new roofing system.
- Providing for proper drainage of the new roof system to eliminate ponding. Provisions must be made to ensure the new roof system has proper drainage, i.e., placement of additional roof drains, use of tapered insulation, use of crickets, etc., as appropriate.
- The existing membrane surface is in basically sound condition, without excessive quantities of defects such as blisters, ridges, fishmouths, or other irregularities.
- The existing roof system components are well attached to each other and their substrate.
- Existing substrates and insulation (if applicable) are dry over the majority of the roof area. Wet or deteriorated areas of insulation and substrate must be removed and replaced with new materials.
- The existing detail conditions are readily adaptable to the increased thicknesses imposed by the re-cover system and comply with GAF specifications and requirements.
- The existing structure is capable of supporting the new loads imposed by the re-cover system.
- All applicable code requirements must be met for re-cover over an existing roofing system.
- It is highly recommended that a moisture survey be made to determine the extent of wet insulation and moisture entrapment.
- Roof systems having existing vapor retarders must be addressed with our Helpline at 1-800-766-3411.

Specific Re-cover Deck Requirements— Steel, Gypsum, Wood, and Cementitious Structural Wood Fiber (Tectum)

- When GAFGLAS® Stratavent® Venting Base Sheet is used as the first ply, the surface of the old smooth BUR membrane must be primed using Matrix™ 307 Premium Asphalt Primer and allowed to dry. Install GAFGLAS® Stratavent® Venting Base Sheet and the proper roof specification listed in this Manual.
- GAF does not recommend partial re-cover or reroofing of a single roof area due to the potential for defects in the portion of the roof system not replaced to damage or negatively affect the performance of the new membrane. When required by project conditions or budget considerations, GAF requires full separation of the old and new roof areas by means of a full curb-mounted expansion joint or area divider installed to provide a complete, watertight seal or break between areas. Tie-in construction in which the old and new membranes are adhered directly to each other and stripped in is not acceptable for use in GAF-guaranteed roof systems.
- Any gravel surfacing must be removed to provide a smooth surface
- On smooth-surface roofs, the old roof surface should be level and clean
- Remove all wet or damaged roof insulation and old, wet membrane. Replace with new insulation of the same type and cover with new membrane to complete the repair.
- Old membrane must be cut on 3-foot (914 mm) centers to allow for the release of any trapped vapor pressure in the old roof covering.
- Additional insulation is used for re-cover assemblies, and mechanical fasteners or a minimum of 70% asphalt attachment is required. Re-cover installations with asphalt-applied insulation require preparation of the roof surface to remove all aggregate surfacing and provide a smooth, clean substrate. The old surface must be primed with asphalt primer prior to mopping. Re-covering over existing modified bitumen smooth, granule-surfaced roof systems, and single-ply systems where the membrane has been removed, requires the use of a mechanically attached insulation.
- When insulation is used, it must be mechanically fastened to steel decks. On cementitious structural wood fiber and gypsum decks, after removing any gravel, new insulation can be mopped to achieve a minimum of 70% attachment. The surface of the old BUR roof surface must be primed before mopping in the insulation. Install new roof specification to insulation as outlined in this Manual.
- Topside venting is required. Use vent stacks installed at the rate of one per 1,000 square feet (92.9 m²) or use perimeter venting.
- All specification requirements and recommendations listed in this Manual must be followed, i.e., slope, nailing, etc.
- If the old roof is a coal-tar BUR, a divorcing layer of roof insulation must be used. Proper precautions must be taken to ensure that coal-tar drippage into the building does not occur. Careful preparation and cleaning of the existing roof surface is required to permit asphalt application of re-cover insulation. Contact the GAF Helpline for additional information.

Re-cover Over Concrete

- Any gravel surfacing must be removed to provide a smooth surface.
- On smooth-surface (including cap sheet) roofs, the old roof surface should be level and clean.
- Additional insulation is used for re-cover assemblies, and mechanical fasteners or a minimum of 70% asphalt attachment is required. Re-cover installations with asphalt-applied insulation require preparation of the roof surface to remove all aggregate surfacing and provide a smooth, clean substrate. The old surface must be primed with asphalt primer prior to mopping. Re-covering over existing modified bitumen smooth, granule-surfaced roof systems, and single-ply systems where the membrane has been removed, requires the use of a mechanically attached insulation.
- Topside venting is required. Use vent stacks installed at the rate of one per 1,000 square feet (92.9 m²) or use perimeter venting.
- All specification requirements and recommendations listed in this Manual must be followed, i.e., slope, nailing, etc.
- If the old roof is a coal-tar BUR, a divorcing layer of roof insulation must be used. Proper precautions must be taken to ensure that coal-tar drippage into the building does not occur. Careful preparation and cleaning of the existing roof surface is required to permit asphalt application of re-cover insulation. Contact the GAF Technical Services Helpline for additional information.

Re-cover Over Lightweight Insulating Concrete

- Re-covering directly over an old existing roof membrane is not acceptable over a lightweight insulating concrete deck.
- Old membranes and existing roof insulation, if present, must be removed. If the decking is suitable to receive a new roof system, the appropriate GAF specification must be followed.
- Topside venting is required. Use vent stacks installed at the rate of one per 1,000 square feet (92.9 m²) or use perimeter venting.
- Topside venting is required. Use vent stacks installed at the rate of one per 1,000 square feet (92.9 m²) or use perimeter venting.

Re-cover Over Loadmaster™ Decks

- The metal deck must be 25 gauge or heavier.
- Roof deck components must be installed by a Loadmaster™-approved contractor in accordance with Loadmaster's specifications.
- The building owner or their representative (not GAF) is responsible for establishing the Loadmaster™ decks and deck support system's suitability and ability to receive and support the additional weight of any re-cover or reroofing assembly.
- All surface gravel must be removed to provide a smooth surface.
- For re-cover applications, a minimum 2-ply modified bitumen or 4-ply smooth or granule-surfaced built-up roofing specification is required. Gravel-surfaced BUR membranes may only be used on complete tear-offs and reroofing specifications over replaced or overlaid Loadmaster™ Duraflex board.
- Only GAF roof systems finished with white granule-surfaced membranes, light-colored gravel surfacing, and approved light-colored TOPCOAT® protective coatings are approved for use over Loadmaster™ roof decks.
- Topside venting is required for re-cover installations. Use vent stacks installed at the rate of one per 1,000 square feet (92.9 m²) or use perimeter venting.

FOR REROOFING APPLICATIONS, LOADMASTER™ SYSTEMS, INC., RECOMMENDS REPLACEMENT OR OVERLAY OF THE DURAFLEX BOARD.

• **Overlay With New Duraflex Board**

Remove the existing roof system and flashings down to the Duraflex board. Replace any wet or damaged boards and install the new Duraflex board over the prepared existing substrate, fastened to Loadmaster™ specifications. Install the selected roof specification in accordance with GAF requirements.

• **Replacement of Duraflex Board**

Remove the existing roof system and flashings, including the Duraflex board and insulation components, if present, and replace in accordance with Loadmaster™ specifications. Install the selected roof specification in accordance with GAF requirements.

RE-COVER OVER EXISTING SMOOTH OR GRANULE-SURFACED ASPHALT BUR AND MODIFIED BITUMEN MEMBRANES:

GAF re-cover assemblies are available as well. However, the responsibility for all alterations, additions, or changes to the roof deck assembly that result remains the responsibility of the building owner or their representative and not GAF.

• **Prime Existing Membrane** – Re-cover with Perforated GAFGLAS® Stratavent® Venting Base Sheet (for existing asphalt BUR and SBS modified bitumen membranes only)

Prepare existing roof surface in accordance with GAF reroofing and re-cover requirements. Prime the prepared surface and install GAFGLAS® Stratavent® Venting Base Sheet and new roof system per GAF specifications.

• **Prime Existing Membrane** – Re-cover with Insulation Mopped

Prepare existing roof surface in accordance with GAF reroofing and re-cover requirements. Prime the prepared surface and install approved EnergyGuard™ roof insulation to achieve a minimum 70% asphalt attachment and new roof system per GAF specifications.

• **Re-cover with Insulation Mechanically Attached**

Prepare existing roof surface in accordance with GAF reroofing and re-cover requirements. Loadmaster™ re-cover installations with additional insulation require prior approval by and submittal of fastener pull tests to GAF Technical Services. Install EnergyGuard™ roof insulation with Drill-Tec™ Fasteners and Plates. Install new roof system per GAF requirements.

• It is **mandatory** in a reroofing situation that all existing flashing be removed.

Note: The new membrane and any new insulation will cause changes in edge details and the height of perimeter nailers.

• All perimeter and top-of-curb flashings must remain open (unsealed). All curb and wall flashings left open must have counterflashing.

• All old metal gravel stops, metal counterflashing, lead boots, and pitch pans must be removed and replaced with new metal.

• All base flashings must be removed and new base flashing must be installed.

Re-cover/
Reroofing
Flashing
Details

GAF ASPHALTIC ROOFING PRODUCT GUIDE

PRODUCT NAME	ASTM	TYPE			PRIMARY APPLICATION METHOD			
		BUR	APP	SBS	HOT-APPLIED	COLD-APPLIED	TORCH/HEAT-WELD APPLIED	SELF-ADHERED MECHANICALLY
GAFGLAS® Stratavent [®] Nailable Venting Base Sheet (Formerly GAFGLAS® Stratavent® Eliminator™ Nailable Venting Base Sheet)	D4897 Type II	X						X
GAFGLAS® Stratavent [®] Perforated Venting Base Sheet (Formerly GAFGLAS® Stratavent® Eliminator™ Perforated Venting Base Sheet)	D4897 Type II	X			X			
GAFGLAS® #75 Base Sheet	D4601 Type II	X			X	X		X
GAFGLAS® #80 Ultima™ Base Sheet	D4601 Type II	X			X	X		X
GAFGLAS® Ply 4 Ply Sheet	D2178 Type IV	X			X			
GAFGLAS® FlexPly™ 6 Ply Sheet	D2178 Type VI	X			X			
GAFGLAS® Mineral-Surfaced Cap Sheet	D3909	X			X			
GAFGLAS® EnergyCap™ Mineral-Surfaced Cap Sheet (Formerly GAFGLAS® EnergyCap™ BUR Mineral Surfaced Cap Sheet)	D3909	X			X			
RUBEROID® Torch Smooth	D6222 Type I, Grade S		X				X	
RUBEROID® Torch Granule	D6222 Type I, Grade G		X				X	
RUBEROID® EnergyCap™ Torch Granule FR	D6222 Type I, Grade G		X				X	
RUBEROID® Torch Plus Granule FR (Formerly RUBEROID® Torch FR)	D6222 Type II, Grade G		X				X	
RUBEROID® EnergyCap™ Torch Plus Granule FR (Formerly RUBEROID® EnergyCap™ Torch Plus FR)	D6222 Type II, Grade G		X				X	
RUBEROID® HW 25 Smooth (Formerly RUBEROID® SBS Heat-Weld™ 25)	D6163 Type I, Grade S			X			X	
RUBEROID® HW Smooth (Formerly RUBEROID® SBS Heat-Weld™ Smooth)	D6164 Type I, Grade S			X			X	
RUBEROID® HW Granule (Formerly RUBEROID® SBS Heat-Weld™ Granule)	D6164 Type I, Grade G			X			X	
RUBEROID® HW Granule FR (Formerly RUBEROID® HW GRANULE FR)	D6164 Type I, Grade G			X			X	
RUBEROID® HW Plus Granule (Formerly RUBEROID® SBS Heat-Weld™ Plus)	D6164 Type II, Grade G			X			X	
RUBEROID® HW Plus Granule FR (Formerly RUBEROID® SBS Heat-Weld™ FR)	D6164 Type II, Grade G			X			X	
RUBEROID® EnergyCap™ HW Plus Granule FR (RUBEROID® EnergyCap™ SBS Heat-Weld™ Plus FR)	D6164 Type II, Grade G			X			X	
RUBEROID® 20 Smooth (Formerly RUBEROID® 20)	D6163 Type I, Grade S			X			X	

PRODUCT NAME	ASTM	TYPE		PRIMARY APPLICATION METHOD				
		BUR	APP	SBS	HOT-APPLIED	COLD-APPLIED	TORCH/HEAT-WELD APPLIED	SELF-ADHERED MECHANICALLY
RUBEROID® 30 Granule (Formerly RUBEROID® 30)	D6163 Type I, Grade G			X	X	X		
RUBEROID® 30 Granule FR (Formerly RUBEROID® 30 FR)	D6163 Type I, Grade G			X	X	X		
RUBEROID® EnergyCap™ 30 Granule FR (Formerly RUBEROID® EnergyCap™ 30 FR SBS Membrane)	D6163 Type I, Grade G			X	X	X		
RUBEROID® Mop Smooth	D6164 Type I, Grade S			X	X	X		
RUBEROID® Mop Smooth 1.5	D6164 Type I, Grade S			X	X	X		
RUBEROID® Mop Granule	D6164 Type I, Grade G			X	X	X		
RUBEROID® Mop Granule FR (Formerly RUBEROID® Mop 170 FR)	D6164 Type I, Grade G			X	X	X		
RUBEROID® Mop Plus Smooth	D6164 Type II, Grade S			X	X	X		
RUBEROID® Mop Plus Granule (Formerly RUBEROID® Mop Plus)	D6164 Type II, Grade G			X	X	X		
RUBEROID® Mop Plus Granule FR (Formerly RUBEROID® Mop FR)	D6164 Type II, Grade G			X	X	X		
RUBEROID® EnergyCap™ Mop Plus Granule FR (Formerly RUBEROID® EnergyCap™ Mop FR)	D6164 Type II, Grade G			X	X	X		
RUBEROID® Ultraclad® SBS	D6298			X		X		
LIBERTY™ SBS Mechanically Attached Base Sheet (Formerly LIBERTY™ MA Mechanically Attached Base Sheet)	D6163 Type I, Grade S			X				X
LIBERTY™ SBS Self-Adhering Base/Ply Sheet	D6163 Type I, Grade S			X				X
LIBERTY™ SBS Self-Adhering Cap Sheet	D6164 Type I, Grade G			X				X

KEY TO SPECIFICATION NUMBERS: RUBEROID® SBS HEAT-WELDED ROOFING SYSTEMS

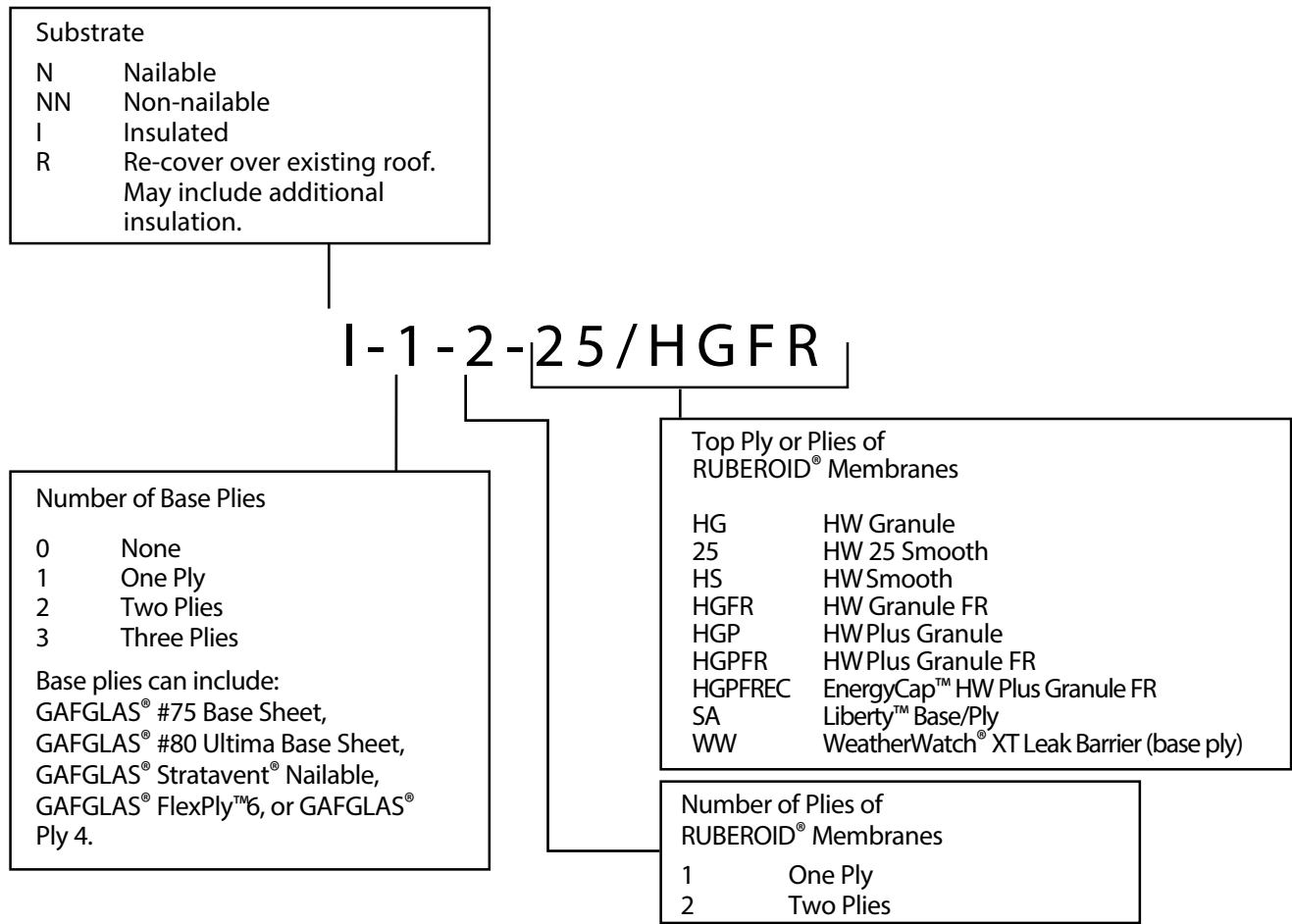

RUBEROID® SBS HEAT-WELD ROOFING SYSTEM CONFIGURATIONS
12-YR DIAMOND PLEDGE™ AND SYSTEM PLEDGE™ GUARANTEE SPECIFICATIONS

<u>PAGE #</u>	<u>DECK</u>	<u>NO. PLIES</u>	<u>SPEC #</u>	<u>BOTTOM SHEET ATTACHMENT</u>	<u>BASE SHEET</u>	<u>INTERPLY</u>	<u>INTERPLY</u>	<u>INTERPLY</u>	<u>CAP</u>
51	INSULATION	2	I-1-1-HG	MOP TO PERLITE MOP TO PERLITE SCREWS & PLATES SCREWS & PLATES	#75 BASE SHEET #80 ULTIMA™ BASE SHEET #75 BASE SHEET #80 ULTIMA™ BASE SHEET	INTERPLY	INTERPLY	INTERPLY	HW GRANULE HW GRANULE HW GRANULE HW GRANULE
51		2	I-1-1-HGFR	MOP TO PERLITE MOP TO PERLITE SCREWS & PLATES SCREWS & PLATES	#75 BASE SHEET #80 ULTIMA BASE SHEET #75 BASE SHEET #80 ULTIMA BASE SHEET				HW GRANULE FR HW GRANULE FR HW GRANULE FR HW GRANULE FR
57	NON-NAILABLE	2	NN-0-2-25/HG	TORCH	HW 25 SMOOTH				SBS HEAT-WELD
57		2	NN-0-2-25/HGFR	TORCH	HW 25 SMOOTH				HW GRANULE FR
57		2	NN-0-2-HG	TORCH	HW SMOOTH				HW GRANULE
57		2	NN-0-2-HGFR	TORCH	HW SMOOTH				HW GRANULE FR
58	NAILABLE	2	N-1-1-HG	NAIL NAIL NAIL	#75 BASE SHEET #80 ULTIMA™ BASE SHEET STRATAVENT® NAILABLE				HW GRANULE HW GRANULE HW GRANULE
58		2	N-1-1-HGFR NAIL	NAIL #80 ULTIMA BASE SHEET NAIL	#75 BASE SHEET STRATAVENT® NAILABLE				HW GRANULE FR HW GRANULE FR HW GRANULE FR
63	LIGHTWEIGHT CONCRETE	2	N-1-1-HG	FASTENER	STRATAVENT® NAILABLE				HW GRANULE
63		2	N-1-1-HGFR	FASTENER	STRATAVENT® NAILABLE				HW GRANULE FR

15-YR DIAMOND PLEDGE™ AND SYSTEM PLEDGE™ GUARANTEE SPECIFICATIONS

<u>PAGE #</u>	<u>DECK</u>	<u>NO. PLIES</u>	<u>SPEC #</u>	<u>BOTTOM SHEET ATTACHMENT</u>	<u>BASE SHEET</u>	<u>INTERPLY</u>	<u>INTERPLY</u>	<u>INTERPLY</u>	<u>CAP</u>
55	INSULATION	3	I-2-1-HG	MOP TO PERLITE MOP TO PERLITE		INTERPLY PLY 4 FLEXPLY™ 6	INTERPLY PLY 4 FLEXPLY™ 6	INTERPLY PLY 4 FLEXPLY™ 6	HW GRANULE HW GRANULE HW GRANULE
55		3	I-2-1-HGFR	MOP TO PERLITE MOP TO PERLITE		PLY 4 FLEXPLY™ 6 LIBERTY™ BASE/PLY	PLY 4 FLEXPLY™ 6 LIBERTY™ BASE/PLY	PLY 4 FLEXPLY™ 6 LIBERTY™ BASE/PLY	HW GRANULE FR HW GRANULE FR HW GRANULE
52		2	I-0-2-SA/HG	SA TO ISO					HW GRANULE
52		2	I-0-2-SA/HGFR	SA TO ISO					HW GRANULE FR
51		2	I-1-1-HGP	MOP TO PERLITE MOP TO PERLITE	#75 BASE SHEET #80 ULTIMA BASE SHEET				HW PLUS GRANULE HW PLUS GRANULE

15-YR DIAMOND PLEDGE™ AND SYSTEM PLEDGE™ GUARANTEE SPECIFICATIONS (continued)

PAGE #	DECK INSULATION	NO. PLIES	SPEC #	BOTTOM SHEET ATTACHMENT	BASE SHEET	INTERPLY	INTERPLY	INTERPLY	CAP
51		2	I-1-1-HGPFRR	MOP TO PERLITE MOP TO PERLITE	#75 BASE SHEET #80 ULTIMA BASE SHEET				HW PLUS GRANULE FR HW PLUS GRANULE FR
51		2	I-1-1-HGPFREC	MOP TO PERLITE MOP TO PERLITE	#75 BASE SHEET #80 ULTIMA™ BASE SHEET				ENERGYCAP™ HW PLUS GRANULE FR ENERGYCAP™ HW PLUS GRANULE FR
53		3	I-1-2-25/HG	MOP TO PERLITE MOP TO PERLITE SCREWS & PLATES SCREWS & PLATES	#75 BASE SHEET #80 ULTIMA BASE SHEET #75 BASE SHEET #80 ULTIMA BASE SHEET	HW 25 SMOOTH HW 25 SMOOTH HW 25 SMOOTH HW 25 SMOOTH			HW GRANULE HW GRANULE HW GRANULE HW GRANULE
53		3	I-1-2-25/HGFR	MOP TO PERLITE MOP TO PERLITE SCREWS & PLATES SCREWS & PLATES	#75 BASE SHEET #80 ULTIMA BASE SHEET #75 BASE SHEET #80 ULTIMA BASE SHEET	HW 25 SMOOTH HW 25 SMOOTH HW 25 SMOOTH HW 25 SMOOTH			HW GRANULE FR HW GRANULE FR HW GRANULE FR HW GRANULE FR
53		3	I-1-2-HG	MOP TO PERLITE MOP TO PERLITE SCREWS & PLATES SCREWS & PLATES	#75 BASE SHEET #80 ULTIMA BASE SHEET #75 BASE SHEET #80 ULTIMA BASE SHEET	HW SMOOTH HW SMOOTH HW SMOOTH HW SMOOTH			HW GRANULE HW GRANULE HW GRANULE HW GRANULE
53		3	I-1-2-HGFR	MOP TO PERLITE MOP TO PERLITE SCREWS & PLATES SCREWS & PLATES	#75 BASE SHEET #80 ULTIMA BASE SHEET #75 BASE SHEET #80 ULTIMA BASE SHEET	HW SMOOTH HW SMOOTH HW SMOOTH HW SMOOTH			HW GRANULE FR HW GRANULE FR HW GRANULE FR HW GRANULE FR
61	NAILABLE	3	N-2-1-HGP	NAIL NAIL NAIL	#75 BASE SHEET #80 ULTIMA™ BASE SHEET STRATAVENT® NAILABLE	FLEXPLY™ 6 FLEXPLY™ 6 FLEXPLY™ 6			HW PLUS GRANULE HW PLUS GRANULE HW PLUS GRANULE
61		3	N-2-1-HGPFRR	NAIL NAIL NAIL	#75 BASE SHEET #80 ULTIMA BASE SHEET STRATAVENT® NAILABLE	FLEXPLY™ 6 FLEXPLY™ 6 FLEXPLY™ 6			HW PLUS GRANULE FR HW PLUS GRANULE FR HW PLUS GRANULE FR
61		3	N-2-1-HGPFREC	NAIL NAIL NAIL	#75 BASE SHEET #80 ULTIMA™ BASE SHEET STRATAVENT® NAILABLE	FLEXPLY™ 6 FLEXPLY™ 6 FLEXPLY™ 6			ENERGYCAP™ HW PLUS GRANULE FR ENERGYCAP™ HW PLUS GRANULE FR ENERGYCAP™ HW PLUS GRANULE FR
59		3	N-1-2-25/HG	NAIL NAIL NAIL	#75 BASE SHEET #80 ULTIMA BASE SHEET STRATAVENT® NAILABLE	HW 25 SMOOTH HW 25 SMOOTH HW 25 SMOOTH			HW GRANULE HW GRANULE HW GRANULE
59		3	N-1-2-25/HGFR	NAIL NAIL NAIL	#75 BASE SHEET #80 ULTIMA BASE SHEET STRATAVENT® NAILABLE	HW 25 SMOOTH HW 25 SMOOTH HW 25 SMOOTH			HW GRANULE FR HW GRANULE FR HW GRANULE FR
59		3	N-1-2-HG	NAIL NAIL NAIL	#75 BASE SHEET #80 ULTIMA BASE SHEET STRATAVENT® NAILABLE	HW SMOOTH HW SMOOTH HW SMOOTH			HW GRANULE HW GRANULE HW GRANULE

15-YR DIAMOND PLEDGE™ AND SYSTEM PLEDGE™ GUARANTEE SPECIFICATIONS (CONTINUED)

PAGE #	DECK	NO. PLIES	SPEC #	BOTTOM SHEET ATTACHMENT	BASE SHEET	INTERPLY	INTERPLY	INTERPLY	CAP
55	AVAILABLE	3	N-1-2-HGFR	NAIL	#75 BASE SHEET	INTERPLY HW SMOOTH	INTERPLY	INTERPLY	HW GRANULE FR
				NAIL	#80 ULTIMA BASE SHEET	HW SMOOTH			HW GRANULE FR
				NAIL	STRATAVENT® NAILABLE	HW SMOOTH			HW GRANULE FR
65	LIGHTWEIGHT CONCRETE	3	N-2-1-HGP	FASTENER	STRATAVENT® NAILABLE	FLEXPLY™ 6			HW PLUS GRANULE
675		3	N-2-1-HGPFRR	FASTENER	STRATAVENT® NAILABLE	FLEXPLY™ 6			HW PLUS GRANULE FR
65		3	N-2-1-HGPFREC	FASTENER	STRATAVENT® NAILABLE	FLEXPLY™ 6			ENERGYCAP™ HW PLUS GRANULE FR
65		3	N-1-2-25/HG	FASTENER	STRATAVENT® NAILABLE	HW 25 SMOOTH			HW GRANULE
64		3	N-1-2-25/HGFR	FASTENER	STRATAVENT® NAILABLE	HW 25 SMOOTH			HW GRANULE FR
64		3	N-1-2-HG	FASTENER	STRATAVENT® NAILABLE	HW SMOOTH			HW GRANULE
64		3	N-1-2-HGFR	FASTENER	STRATAVENT® NAILABLE	HW SMOOTH			HW GRANULE FR

20-YR DIAMOND PLEDGE™ AND SYSTEM PLEDGE™ GUARANTEE SPECIFICATIONS

PAGE #	DECK	NO. PLIES	SPEC #	BOTTOM SHEET ATTACHMENT	BASE SHEET	INTERPLY	INTERPLY	INTERPLY	CAP
52	INSULATION	2	I-0-2-SA/HGP	SA TO ISO		INTERPLY LIBERTY™ BASE/PLY	INTERPLY	INTERPLY	HW PLUS GRANULE
52		2	I-0-2-SA/HGPFRR	SA TO ISO		LIBERTY™ BASE/PLY			HW PLUS GRANULE FR
52		2	I-0-2-SA/HGPFREC	SA TO ISO		LIBERTY™ BASE/PLY			ENERGYCAP™ HW PLUS GRANULE FR
54		3	I-0-3-WW/25/HGP	SA TO ISO	WEATHERWATCH®	HW 25 SMOOTH			HW PLUS GRANULE
54		3	I-0-3-WW/25/HGPFRR		SA TO ISO	WEATHERWATCH®	HW 25 SMOOTH		HW PLUS GRANULE FR
54		3	I-0-3-WW/25/HGPFREC		SA TO ISO	WEATHERWATCH®	HW 25 SMOOTH		ENERGYCAP™ HW PLUS GRANULE FR
55		3	I-2-1-HGP	MOP TO PERLITE		FLEXPLY™ 6	FLEXPLY™ 6		HW PLUS GRANULE
55		3	I-2-1-HGPFRR	MOP TO PERLITE		FLEXPLY™ 6	FLEXPLY™ 6		HW PLUS GRANULE FR
55		3	I-2-1-HGPFREC	MOP TO PERLITE		FLEXPLY™ 6	FLEXPLY™ 6		ENERGYCAP™ HW PLUS GRANULE FR
54		3	I-1-2-25/HGP	MOP TO PERLITE	#75 BASE SHEET	HW 25 SMOOTH			HW PLUS GRANULE
				MOP TO PERLITE	#80 ULTIMA BASE SHEET	HW 25 SMOOTH			HW PLUS GRANULE
				SCREWS & PLATES	#75 BASE SHEET	HW 25 SMOOTH			HW PLUS GRANULE
				SCREWS & PLATES	#80 ULTIMA BASE SHEET	HW 25 SMOOTH			HW PLUS GRANULE
54		3	I-1-2-25/HGPFRR	MOP TO PERLITE	#75 BASE SHEET	HW 25 SMOOTH			HW PLUS GRANULE FR
				MOP TO PERLITE	#80 ULTIMA BASE SHEET	HW 25 SMOOTH			HW PLUS GRANULE FR
				SCREWS & PLATES	#75 BASE SHEET	HW 25 SMOOTH			HW PLUS GRANULE FR
				SCREWS & PLATES	#80 ULTIMA BASE SHEET	HW 25 SMOOTH			HW PLUS GRANULE FR

20-YR DIAMOND PLEDGE™ AND SYSTEM PLEDGE™ GUARANTEE SPECIFICATIONS (CONTINUED)

PAGE #	DECK	NO. PLYS	SPEC #	BOTTOM SHEET ATTACHMENT	BASE SHEET	INTERPLY	INTERPLY	INTERPLY	CAP
54	INSULATION	3	I-1-2-25/HGPFREC	MOP TO PERLITE MOP TO PERLITE SCREWS & PLATES SCREWS & PLATES	#75 BASE SHEET #80 ULTIMA™ BASE SHEET #75 BASE SHEET #80 ULTIMA™ BASE SHEET	HW 25 SMOOTH HW 25 SMOOTH HW 25 SMOOTH HW 25 SMOOTH	INTERPLY	INTERPLY	ENERGYCAP™ HW PLUS GRANULE FR ENERGYCAP™ HW PLUS GRANULE FR ENERGYCAP™ HW PLUS GRANULE FR ENERGYCAP™ HW PLUS GRANULE FR
54		3	I-1-2-HGP	MOP TO PERLITE MOP TO PERLITE SCREWS & PLATES SCREWS & PLATES	#75 BASE SHEET #80 ULTIMA™ BASE SHEET #75 BASE SHEET #80 ULTIMA™ BASE SHEET	HW SMOOTH HW SMOOTH HW SMOOTH HW SMOOTH			HW PLUS GRANULE HW PLUS GRANULE HW PLUS GRANULE HW PLUS GRANULE
54		3	I-1-2-HGPFREC	MOP TO PERLITE MOP TO PERLITE SCREWS & PLATES SCREWS & PLATES	#75 BASE SHEET #80 ULTIMA™ BASE SHEET #75 BASE SHEET #80 ULTIMA™ BASE SHEET	HW SMOOTH HW SMOOTH HW SMOOTH HW SMOOTH			ENERGYCAP™ HW PLUS GRANULE FR ENERGYCAP™ HW PLUS GRANULE FR ENERGYCAP™ HW PLUS GRANULE FR ENERGYCAP™ HW PLUS GRANULE FR
56		3	I-1-2-HGPF	MOP TO PERLITE MOP TO PERLITE SCREWS & PLATES SCREWS & PLATES	#75 BASE SHEET #80 ULTIMA™ BASE SHEET #75 BASE SHEET #80 ULTIMA™ BASE SHEET	HW SMOOTH HW SMOOTH HW SMOOTH HW SMOOTH			HW PLUS GRANULE FR HW PLUS GRANULE FR HW PLUS GRANULE FR HW PLUS GRANULE FR
56		4	I-3-1-HGP	MOP TO PERLITE MOP TO PERLITE	PLY 4 FLEXPLY™ 6	PLY 4 FLEXPLY™ 6	PLY 4 FLEXPLY™ 6	PLY 4 FLEXPLY™ 6	HW PLUS GRANULE HW PLUS GRANULE
5		4	I-3-1-HGPF	MOP TO PERLITE MOP TO PERLITE	PLY 4 FLEXPLY™ 6	PLY 4 FLEXPLY™ 6	PLY 4 FLEXPLY™ 6	PLY 4 FLEXPLY™ 6	HW PLUS GRANULE FR HW PLUS GRANULE FR
56		4	I-3-1-HGPFREC	MOP TO PERLITE MOP TO PERLITE	PLY 4 FLEXPLY™ 6	PLY 4 FLEXPLY™ 6	PLY 4 FLEXPLY™ 6	PLY 4 FLEXPLY™ 6	ENERGYCAP™ HW PLUS GRANULE FR ENERGYCAP™ HW PLUS GRANULE FR
60	NAILABLE	3	N-1-2-25/HGP	NAIL NAIL NAIL	#75 BASE SHEET #80 ULTIMA™ BASE SHEET STRATAVENT® NAILABLE	HW 25 SMOOTH HW 25 SMOOTH HW 25 SMOOTH			HW PLUS GRANULE HW PLUS GRANULE HW PLUS GRANULE
60		3	N-1-2-25/HGPF	NAIL NAIL NAIL	#75 BASE SHEET #80 ULTIMA™ BASE SHEET STRATAVENT® NAILABLE	HW 25 SMOOTH HW 25 SMOOTH HW 25 SMOOTH			HW PLUS GRANULE FR HW PLUS GRANULE FR HW PLUS GRANULE FR
60		3	N-1-2-25/HGPFREC	NAIL NAIL NAIL	#75 BASE SHEET #80 ULTIMA™ BASE SHEET STRATAVENT® NAILABLE	HW 25 SMOOTH HW 25 SMOOTH HW 25 SMOOTH			ENERGYCAP™ HW PLUS GRANULE FR ENERGYCAP™ HW PLUS GRANULE FR ENERGYCAP™ HW PLUS GRANULE FR
60		3	N-1-2-HGP	NAIL NAIL NAIL	#75 BASE SHEET #80 ULTIMA™ BASE SHEET STRATAVENT® NAILABLE	HW SMOOTH HW SMOOTH HW SMOOTH			HW PLUS GRANULE HW PLUS GRANULE HW PLUS GRANULE
60		3	N-1-2-HGPF	NAIL NAIL NAIL	#75 BASE SHEET #80 ULTIMA™ BASE SHEET STRATAVENT® NAILABLE	HW SMOOTH HW SMOOTH HW SMOOTH			HW PLUS GRANULE FR HW PLUS GRANULE FR HW PLUS GRANULE FR

20-YR DIAMOND PLEDGE™ AND SYSTEM PLEDGE™ GUARANTEE SPECIFICATIONS (CONTINUED)

<u>PAGE #</u>	<u>DECK</u>	<u>NO. PLYS</u>	<u>SPEC.#</u>	<u>BOTTOM SHEET ATTACHMENT</u>	<u>BASE SHEET</u>	<u>INTERPLY</u>	<u>INTERPLY</u>	<u>INTERPLY</u>	<u>CAP</u>
60	NAILABLE	3	N-1-2-HGPFREC	NAIL	#75 BASE SHEET	HW SMOOTH			ENERGYCAP™ HW PLUS GRANULE FR
				NAIL	#80 ULTIMA™ BASE SHEET	HW SMOOTH			ENERGYCAP™ HW PLUS GRANULE FR
				NAIL	STRATAVENT® NAILABLE	HW SMOOTH			ENERGYCAP™ HW PLUS GRANULE FR
62		4	N-3-1-HGP	NAIL	#75 BASE SHEET	FLEXPLY™ 6	FLEXPLY™ 6		HW PLUS GRANULE
				NAIL	#80 ULTIMA BASE SHEET	FLEXPLY™ 6	FLEXPLY™ 6		HW PLUS GRANULE
				NAIL	STRATAVENT® NAILABLE	FLEXPLY™ 6	FLEXPLY™ 6		HW PLUS GRANULE
62		4	N-3-1-HGPFER	NAIL	#75 BASE SHEET	FLEXPLY™ 6	FLEXPLY™ 6		HW PLUS GRANULE FR
				NAIL	#80 ULTIMA BASE SHEET	FLEXPLY™ 6	FLEXPLY™ 6		HW PLUS GRANULE FR
				NAIL	STRATAVENT® NAILABLE	FLEXPLY™ 6	FLEXPLY™ 6		HW PLUS GRANULE FR
62		4	N-3-1-HGPFREC	NAIL	#75 BASE SHEET	FLEXPLY™ 6	FLEXPLY™ 6		ENERGYCAP™ HW PLUS GRANULE FR
				NAIL	#80 ULTIMA™ BASE SHEET	FLEXPLY™ 6	FLEXPLY™ 6		ENERGYCAP™ HW PLUS GRANULE FR
				NAIL	STRATAVENT® NAILABLE	FLEXPLY™ 6	FLEXPLY™ 6		ENERGYCAP™ HW PLUS GRANULE FR
66	LIGHTWEIGHT CONCRETE	4	N-3-1-HGP	FASTENER	STRATAVENT® NAILABLE	FLEXPLY™ 6	FLEXPLY™ 6		HW PLUS GRANULE
66		4	N-3-1-HGPFER	FASTENER	STRATAVENT® NAILABLE	FLEXPLY™ 6	FLEXPLY™ 6		HW PLUS GRANULE FR
66		4	N-3-1-HGPFREC	FASTENER	STRATAVENT® NAILABLE	FLEXPLY™ 6	FLEXPLY™ 6		ENERGYCAP™ HW PLUS GRANULE FR
64		3	N-1-2-25/HGP	FASTENER	STRATAVENT® NAILABLE	HW 25 SMOOTH			HW PLUS GRANULE
64		3	N-1-2-25/HGPFER	FASTENER	STRATAVENT® NAILABLE	HW 25 SMOOTH			HW PLUS GRANULE FR
64		3	N-1-2-25/HGPFREC	FASTENER	STRATAVENT® NAILABLE	HW 25 SMOOTH			ENERGYCAP™ HW PLUS GRANULE FR
64		3	N-1-2-HGP	FASTENER	STRATAVENT® NAILABLE	HW SMOOTH			HW PLUS GRANULE
64		3	N-1-2-HGPFER	FASTENER	STRATAVENT® NAILABLE	HW SMOOTH			HW PLUS GRANULE FR
64		3	N-1-2-HGPFREC	FASTENER	STRATAVENT® NAILABLE	HW SMOOTH			ENERGYCAP™ HW PLUS GRANULE FR

NOTES



TWO (2) PLY SBS HEAT-WELDED SYSTEM INSULATED DECK

HW-102A

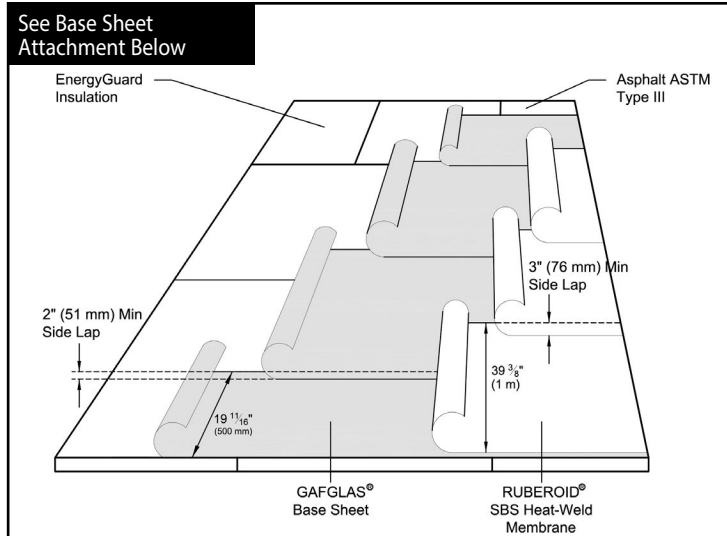

GENERAL

Safety: Refer to Section 1.06.
DO NOT BEGIN INSTALLATION
UNTIL THIS INFORMATION IS READ,
UNDERSTOOD, AND IMPLEMENTED.

MATERIALS

Material Requirements per 100 sq. ft.
(9.29 m²):
Insulation
Asphalt (per ply).....25 lbs. (1.22 kg/m²)
Base Sheet1 ply
Membrane1 ply

12-YEAR DIAMOND PLEDGE™ AND SYSTEM PLEDGE™ GUARANTEES

<u>SPEC#</u>	<u>BOTTOM SHEET ATTACHMENT</u>	<u>BASE SHEET</u>	<u>CAP</u>
I-1-1-HG	MOP TO PERLITE MOP TO PERLITE SCREWS & PLATES SCREWS & PLATES	#75 BASE SHEET #80 ULTIMA™ BASE SHEET #75 BASE SHEET #80 ULTIMA™ BASE SHEET	HW GRANULE HW GRANULE HW GRANULE HW GRANULE
I-1-1-HGFR	MOP TO PERLITE MOP TO PERLITE SCREWS & PLATES SCREWS & PLATES	#75 BASE SHEET #80 ULTIMA™ BASE SHEET #75 BASE SHEET #80 ULTIMA™ BASE SHEET	HW GRANULE FR HW GRANULE FR HW GRANULE FR HW GRANULE FR
1-0-2-WW/HG	SA TO ISO	WEATHERWATCH® XTLEAKBARRIER	HW GRANULE
1-0-2-WW/HGFR	SA TO ISO	WEATHERWATCH® XTLEAKBARRIER	HW GRANULE FR
1-0-2-WW/HGFREC	SA TO ISO	WEATHERWATCH® XTLEAKBARRIER	ENERGYCAP™ HW PLUS GRANULE FR

15-YEAR DIAMOND PLEDGE™ AND SYSTEM PLEDGE™ GUARANTEES

<u>SPEC#</u>	<u>BOTTOM SHEET ATTACHMENT</u>	<u>BASE SHEET</u>	<u>CAP</u>
I-1-1-HGP	MOP TO PERLITE MOP TO PERLITE	#75 BASE SHEET #80 ULTIMA™ BASE SHEET	HW PLUS GRANULE HW PLUS GRANULE
I-1-1-HGPF	MOP TO PERLITE MOP TO PERLITE	#75 BASE SHEET #80 ULTIMA™ BASE SHEET	HW PLUS GRANULE FR HW PLUS GRANULE FR
I-1-1-HGPFREC	MOP TO PERLITE MOP TO PERLITE	#75 BASE SHEET #80 ULTIMA™ BASE SHEET	ENERGYCAP™ SBS HW PLUS GRANULE FR ENERGYCAP™ SBS HW PLUS GRANULE FR



TWO (2) PLY SBS SELF-ADHERING BASE/ SBS HEAT-WELDED SYSTEM – EXISTING PREPARED SURFACE WITH RE-COVER INSULATION

HW-102B

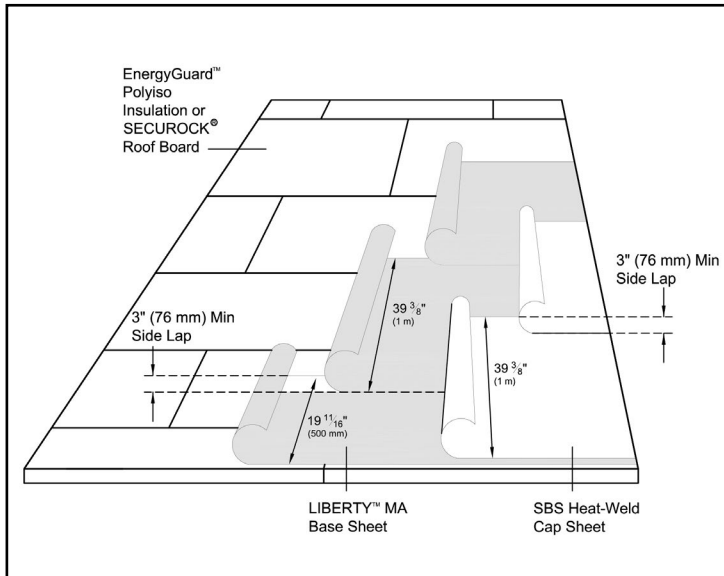

GENERAL

Safety: Refer to Section 1.06.
DO NOT BEGIN INSTALLATION
UNTIL THIS INFORMATION IS READ,
UNDERSTOOD, AND IMPLEMENTED.

MATERIALS

Material Requirements per 100 sq. ft.
(9.29 m²):

Approved Insulation

Liberty™ Base/Ply Sheet.....1 Ply
SBS Heat-Weld Cap Sheet.....1 Ply

15-YEAR DIAMOND PLEDGE™ AND SYSTEM PLEDGE™ GUARANTEE SPECIFICATIONS:

SPEC#	BOTTOM SHEET ATTACHMENT	BASE/ INTERPLY	CAP
I-0-2-SA/HG	SA TO ISO	LIBERTY™ BASE/PLY	HW GRANULE
I-0-2-SA/HGFR	SA TO ISO	LIBERTY™ BASE/PLY	HW GRANULE FR

20-YEAR DIAMOND PLEDGE™ AND SYSTEM PLEDGE™ GUARANTEE SPECIFICATIONS:

SPEC#	BOTTOM SHEET ATTACHMENT	BASE/ INTERPLY	CAP
I-0-2-SA/HGP	SA TO ISO	LIBERTY™ BASE/PLY	HW PLUS GRANULE
I-0-2-SA/HGPFRR	SA TO ISO	LIBERTY™ BASE/PLY	HW PLUS GRANULE FR
I-0-2-SA/HGPFREC	SA TO ISO	LIBERTY™ BASE/PLY	ENERGYCAP™ HW PLUS GRANULE FR



THREE (3) PLY SBS HEAT-WELDED SYSTEM INSULATED DECK

HW-103

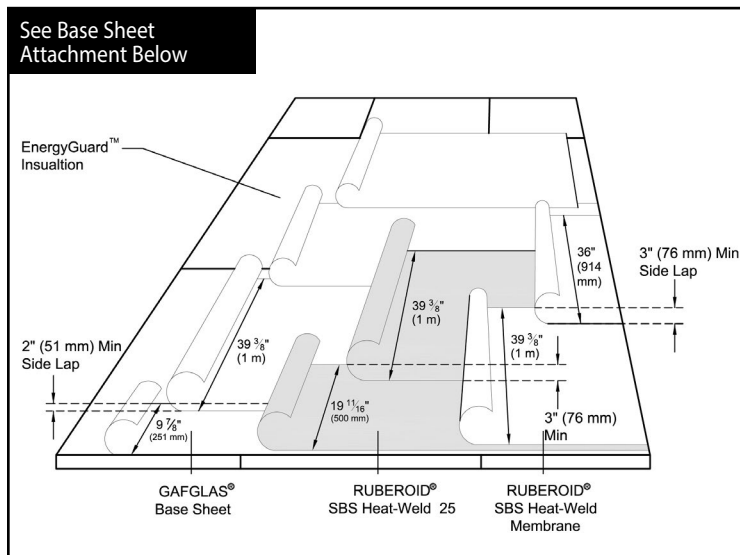

GENERAL

Safety: Refer to Section 1.06.
DO NOT BEGIN INSTALLATION UNTIL THIS INFORMATION IS READ, UNDERSTOOD, AND IMPLEMENTED.

MATERIALS

Material Requirements per 100 sq. ft. (9.29 m²):

Insulation

Asphalt per ply, if applicable

.....25lb. (1.22kg/m²)

Base Sheet1 ply

Interply1 ply

Membrane1 ply

15-YEAR DIAMOND PLEDGE™ AND SYSTEM PLEDGE™ GUARANTEES

	BOTTOM SHEET			
SPEC#	ATTACHMENT	BASE SHEET	INTERPLY	CAP
I-1-2-25/HG	MOP TO PERLITE	#75 BASE SHEET	HW 25 SMOOTH	HW GRANULE
	MOP TO PERLITE	#80 ULTIMA™ BASE SHEET	HW 25 SMOOTH	HW GRANULE
	SCREWS & PLATES	#75 BASE SHEET	HW 25 SMOOTH	HW GRANULE
	SCREWS & PLATES	#80 ULTIMA™ BASE SHEET	HW 25 SMOOTH	HW GRANULE
I-1-2-25/HGFR	MOP TO PERLITE	#75 BASE SHEET	HW 25 SMOOTH	HW GRANULE FR
	MOP TO PERLITE	#80 ULTIMA™ BASE SHEET	HW 25 SMOOTH	HW GRANULE FR
	SCREWS & PLATES	#75 BASE SHEET	HW 25 SMOOTH	HW GRANULE FR
	SCREWS & PLATES	#80 ULTIMA™ BASE SHEET	HW 25 SMOOTH	HW GRANULE FR
I-1-2-HG	MOP TO PERLITE	#75 BASE SHEET	HW SMOOTH	HW GRANULE
	MOP TO PERLITE	#80 ULTIMA™ BASE SHEET	HW SMOOTH	HW GRANULE
	SCREWS & PLATES	#75 BASE SHEET	HW SMOOTH	HW GRANULE
	SCREWS & PLATES	#80 ULTIMA™ BASE SHEET	HW SMOOTH	HW GRANULE
I-1-2-HGFR	MOP TO PERLITE	#75 BASE SHEET	HW SMOOTH	HW GRANULE FR
	MOP TO PERLITE	#80 ULTIMA™ BASE SHEET	HW SMOOTH	HW GRANULE FR
	SCREWS & PLATES	#75 BASE SHEET	HW SMOOTH	HW GRANULE FR
	SCREWS & PLATES	#80 ULTIMA™ BASE SHEET	HW SMOOTH	HW GRANULE FR

CONTINUED ON NEXT PAGE



THREE (3) PLY SBS HEAT-WELDED SYSTEM INSULATED DECK (CONTINUED)

20-YEAR DIAMOND PLEDGE™ AND SYSTEM PLEDGE™ GUARANTEES

<u>SPEC#</u>	<u>BOTTOM SHEET ATTACHMENT</u>	<u>BASE SHEET</u>	<u>INTERPLY</u>	<u>CAP</u>
I-1-2-25/HGP	MOP TO PERLITE	#75 BASE SHEET	HW 25 SMOOTH	HW PLUS GRANULE
	MOP TO PERLITE	#80 ULTIMA™ BASE SHEET	HW 25 SMOOTH	HW PLUS GRANULE
	SCREWS & PLATES	#75 BASE SHEET	HW 25 SMOOTH	HW PLUS GRANULE
	SCREWS & PLATES	#80 ULTIMA™ BASE SHEET	HW 25 SMOOTH	HW PLUS GRANULE
I-1-2-25/HGPFR	MOP TO PERLITE	#75 BASE SHEET	HW 25 SMOOTH	HW PLUS GRANULE FR
	MOP TO PERLITE	#80 ULTIMA™ BASE SHEET	HW 25 SMOOTH	HW PLUS GRANULE FR
	SCREWS & PLATES	#75 BASE SHEET	HW 25 SMOOTH	HW PLUS GRANULE FR
	SCREWS & PLATES	#80 ULTIMA™ BASE SHEET	HW 25 SMOOTH	HW PLUS GRANULE FR
I-1-2-25/HGPFREC	MOP TO PERLITE	#75 BASE SHEET	HW 25 SMOOTH	ENERGYCAP™ HW PLUS GRANULE FR
	MOP TO PERLITE	#80 ULTIMA™ BASE SHEET	HW 25 SMOOTH	ENERGYCAP™ HW PLUS GRANULE FR
	SCREWS & PLATES	#75 BASE SHEET	HW 25 SMOOTH	ENERGYCAP™ HW PLUS GRANULE FR
	SCREWS & PLATES	#80 ULTIMA™ BASE SHEET	HW 25 SMOOTH	ENERGYCAP™ HW PLUS GRANULE FR
I-1-2-HGP	MOP TO PERLITE	#75 BASE SHEET	HW SMOOTH	HW PLUS GRANULE
	MOP TO PERLITE	#80 ULTIMA™ BASE SHEET	HW SMOOTH	HW PLUS GRANULE
	SCREWS & PLATES	#75 BASE SHEET	HW SMOOTH	HW PLUS GRANULE
	SCREWS & PLATES	#80 ULTIMA™ BASE SHEET	HW SMOOTH	HW PLUS GRANULE
I-1-2-HGPFR	MOP TO PERLITE	#75 BASE SHEET	HW SMOOTH	HW PLUS GRANULE FR
	MOP TO PERLITE	#80 ULTIMA™ BASE SHEET	HW SMOOTH	HW PLUS GRANULE FR
	SCREWS & PLATES	#75 BASE SHEET	HW SMOOTH	HW PLUS GRANULE FR
	SCREWS & PLATES	#80 ULTIMA™ BASE SHEET	HW SMOOTH	HW PLUS GRANULE FR
I-1-2-HGPFREC	MOP TO PERLITE	#75 BASE SHEET	HW SMOOTH	ENERGYCAP™ HW PLUS GRANULE FR
	MOP TO PERLITE	#80 ULTIMA™ BASE SHEET	HW SMOOTH	ENERGYCAP™ HW PLUS GRANULE FR
	SCREWS & PLATES	#75 BASE SHEET	HW SMOOTH	ENERGYCAP™ HW PLUS GRANULE FR
	SCREWS & PLATES	#80 ULTIMA™ BASE SHEET	HW SMOOTH	ENERGYCAP™ HW PLUS GRANULE FR
I-0-3-WW/25/HGP	SA TO ISO	WEATHERWATCH® XT LEAK BARRIER	HW 25 SMOOTH	HW PLUS GRANULE
I-0-3-WW/25/HGPFR	SA TO ISO	WEATHERWATCH® XT LEAK BARRIER	HW 25 SMOOTH	HW PLUS GRANULE FR
I-0-3-WW/25/HGPFREC	SA TO ISO	WEATHERWATCH® XT LEAK BARRIER	HW 25 SMOOTH	ENERGYCAP™ HW PLUS GRANULE FR



THREE (3) PLY SBS HEAT-WELDED SYSTEM INSULATED DECK

HW-104

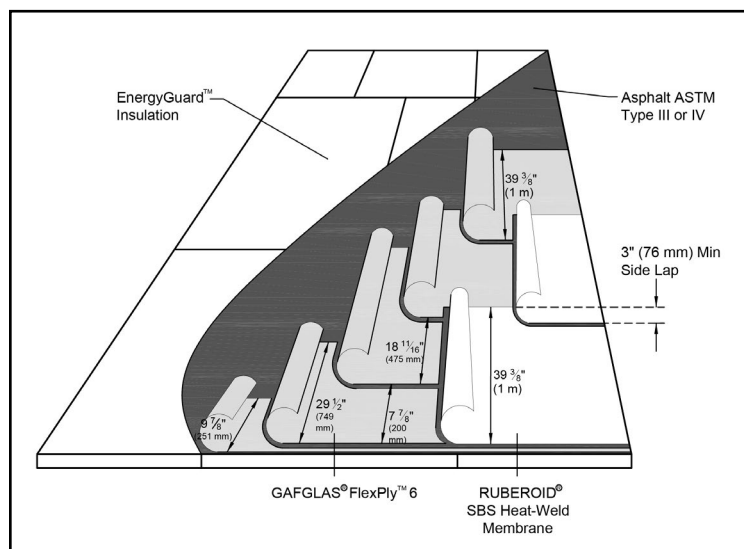

GENERAL

Safety: Refer to Section 1.06.
DO NOT BEGIN INSTALLATION UNTIL THIS INFORMATION IS READ, UNDERSTOOD, AND IMPLEMENTED.

MATERIALS

Material Requirements per 100 sq. ft. (9.29 m²):
Insulation (Perlite)
Asphalt (per ply).....25 lb. (1.22 kg/m²)
Interply2 plies
Membrane1 ply

15-YEAR DIAMOND PLEDGE™ AND SYSTEM PLEDGE™ GUARANTEES

SPEC#	BOTTOM SHEET ATTACHMENT	INTERPLY	INTERPLY	CAP
I-2-1-HG	MOP TO PERLITE MOP TO PERLITE	PLY 4 FLEXPLY™ 6	PLY 4 FLEXPLY™ 6	HW GRANULE HW GRANULE
I-2-1-HGFR	MOP TO PERLITE MOP TO PERLITE	PLY 4 FLEXPLY™ 6	PLY 4 FLEXPLY™ 6	HW GRANULE FR HW GRANULE FR

20-YEAR DIAMOND PLEDGE™ AND SYSTEM PLEDGE™ GUARANTEES

SPEC#	BOTTOM SHEET ATTACHMENT	INTERPLY	INTERPLY	CAP
I-2-1-HGP	MOP TO PERLITE	FLEXPLY™ 6	FLEXPLY™ 6	HW PLUS GRANULE
I-2-1-HGPFRR	MOP TO PERLITE	FLEXPLY™ 6	FLEXPLY™ 6	HW PLUS GRANULE FR
I-2-1-HGPFREC	MOP TO PERLITE	FLEXPLY™ 6	FLEXPLY™ 6	ENERGYCAP™ HW PLUS GRANULE FR

System Configurations



FOUR (4) PLY SBS HEAT-WELDED SYSTEM INSULATED DECK

HW-105

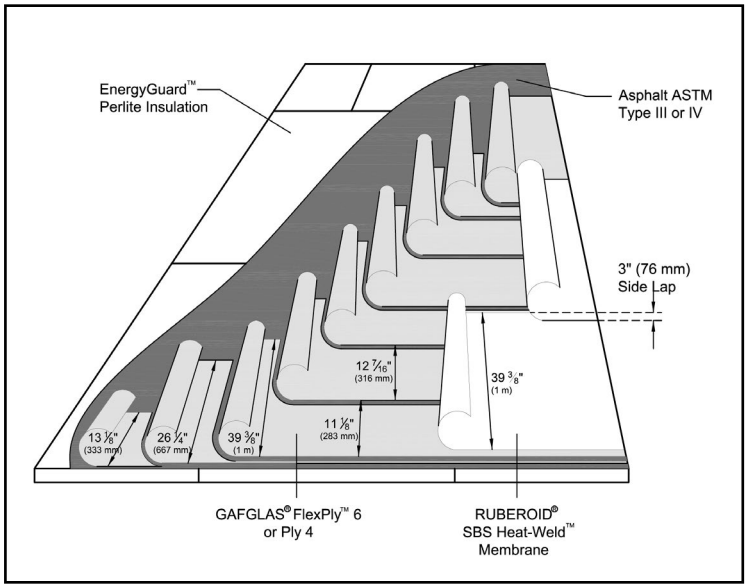

GENERAL

Safety: Refer to Section 1.06.
DO NOT BEGIN INSTALLATION
UNTIL THIS INFORMATION IS READ,
UNDERSTOOD, AND IMPLEMENTED.

MATERIALS

Material Requirements per 100 sq. ft.
(9.29 m²):

- Insulation (Perlite)
- Asphalt (per ply).....25 lb. (1.22 kg/m²)
- Interply3 plies
- Membrane1 ply

20-YEAR DIAMOND PLEDGE™ AND SYSTEM PLEDGE™ GUARANTEES

SPEC#	BOTTOM SHEET				
	ATTACHMENT	INTERPLY	INTERPLY	INTERPLY	CAP
I-3-1-HGP	MOP TO PERLITE	PLY 4	PLY 4	PLY 4	HW PLUS GRANULE
	MOP TO PERLITE	FLEXPLY™ 6	FLEXPLY™ 6	FLEXPLY™ 6	HW PLUS GRANULE
I-3-1-HGPFRR	MOP TO PERLITE	PLY 4	PLY 4	PLY 4	HW PLUS GRANULE FR
	MOP TO PERLITE	FLEXPLY™ 6	FLEXPLY™ 6	FLEXPLY™ 6	HW PLUS GRANULE FR
I-3-1-HGPFREC	MOP TO PERLITE	PLY 4	PLY 4	PLY 4	ENERGYCAP™ HW PLUS GRANULE FR
	MOP TO PERLITE	FLEXPLY™ 6	FLEXPLY™ 6	FLEXPLY™ 6	ENERGYCAP™ HW PLUS GRANULE FR

Note: If GAFGLAS® Stratavent® Perforated Venting Base Sheet is installed under this specification, one interply may be eliminated and the system can be installed directly over EnergyGuard™ Isocyanurate Roof Insulation.



TWO (2) PLY SBS HEAT-WELDED SYSTEM NON-NAILABLE DECK

HW-106

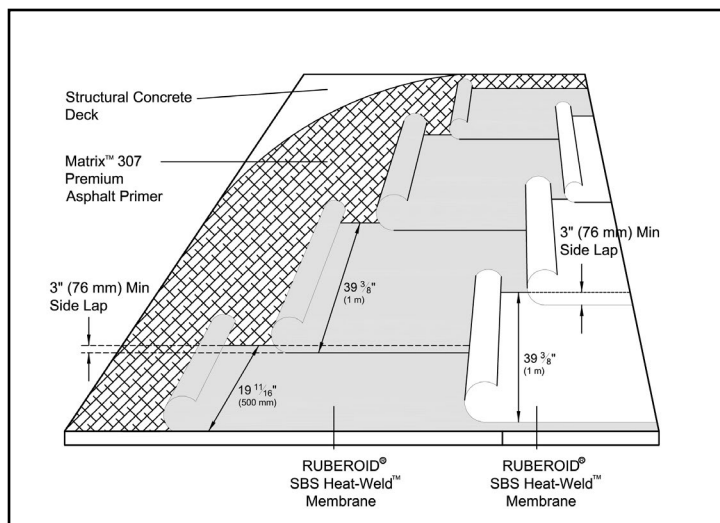

GENERAL

Safety: Refer to Section 1.06.
DO NOT BEGIN INSTALLATION
UNTIL THIS INFORMATION IS READ,
UNDERSTOOD, AND IMPLEMENTED.

MATERIALS

Material Requirements per 100 sq. ft.
(9.29 m²):
Base Sheet1 ply
Membrane1 ply

12-YEAR DIAMOND PLEDGE™ AND SYSTEM PLEDGE™ GUARANTEES

SPEC #	BOTTOM SHEET ATTACHMENT	BASE SHEET	CAP
NN-0-2-25/HG	TORCH	HW 25 SMOOTH	HW GRANULE
NN-0-2-25/HGFR	TORCH	HW 25 SMOOTH	HW GRANULE FR
NN-0-2-HG	TORCH	HW SMOOTH	HW GRANULE
NN-0-2-HGFR	TORCH	HW SMOOTH	HW GRANULE FR



TWO (2) PLY SBS HEAT-WELDED SYSTEM NAILABLE DECK

HW-107

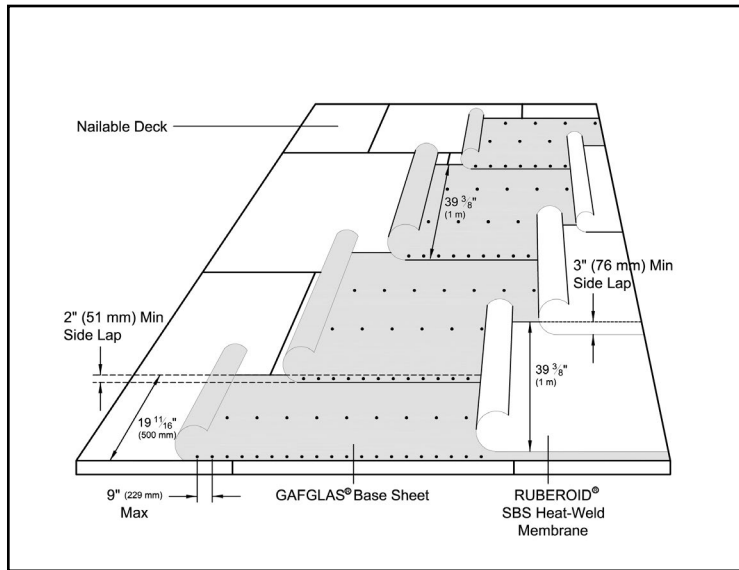

GENERAL

Safety: Refer to Section 1.06.
DO NOT BEGIN INSTALLATION
UNTIL THIS INFORMATION IS READ,
UNDERSTOOD, AND IMPLEMENTED.

MATERIALS

Material Requirements per 100 sq. ft.
(9.29 m²):
Base Sheet1 ply
Membrane1 ply

12-YEAR DIAMOND PLEDGE™ AND SYSTEM PLEDGE™ GUARANTEES

SPEC#	BOTTOM SHEET ATTACHMENT	BASE SHEET	CAP
N-1-1-HG	NAIL	#75 BASE SHEET	HW GRANULE
	NAIL	#80 ULTIMA™ BASE SHEET	HW GRANULE
	NAIL	STRATAVENT® NAILABLE	HW GRANULE
N-1-1-HGFR	NAIL	#75 BASE SHEET	HW GRANULE FR
	NAIL	#80 ULTIMA™ BASE SHEET	HW GRANULE FR
	NAIL	STRATAVENT® NAILABLE	HW GRANULE FR



THREE (3) PLY SBS HEAT-WELDED SYSTEM NAILABLE DECK

HW-108

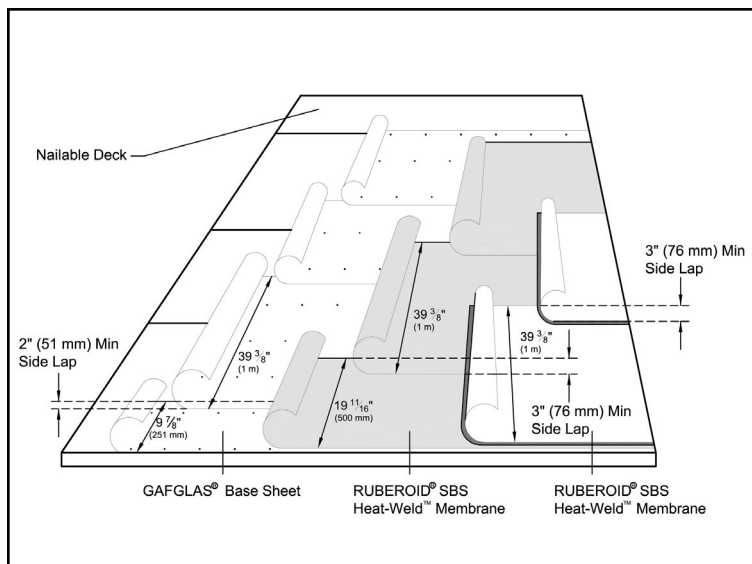

GENERAL

Safety: Refer to Section 1.06.
DO NOT BEGIN INSTALLATION
UNTIL THIS INFORMATION IS READ,
UNDERSTOOD, AND IMPLEMENTED.

MATERIALS

Material Requirements per 100 sq. ft.
(9.29 m²):

- Base Sheet1 ply
- Interply1 ply
- Membrane1 ply

15-YEAR DIAMOND PLEDGE™ AND SYSTEM PLEDGE™ GUARANTEES

SPEC#	BOTTOM SHEET ATTACHMENT	BASE SHEET	INTERPLY CAP	
N-1-2-25/HG	NAIL	#75 BASE SHEET	HW 25 SMOOTH	HW GRANULE
	NAIL	#80 ULTIMA™ BASE SHEET	HW 25 SMOOTH	HW GRANULE
	NAIL	STRATAVENT® NAILABLE	HW 25 SMOOTH	HW GRANULE
N-1-2-25/HGFR	NAIL	#75 BASE SHEET	HW 25 SMOOTH	HW GRANULE FR
	NAIL	#80 ULTIMA™ BASE SHEET	HW 25 SMOOTH	HW GRANULE FR
	NAIL	STRATAVENT® NAILABLE	HW 25 SMOOTH	HW GRANULE FR
N-1-2-HG	NAIL	#75 BASE SHEET	HW SMOOTH	HW GRANULE
	NAIL	#80 ULTIMA™ BASE SHEET	HW SMOOTH	HW GRANULE
	NAIL	STRATAVENT® NAILABLE	HW SMOOTH	HW GRANULE
N-1-2-HGFR	NAIL	#75 BASE SHEET	HW SMOOTH	HW GRANULE FR
	NAIL	#80 ULTIMA™ BASE SHEET	HW SMOOTH	HW GRANULE FR
	NAIL	STRATAVENT® NAILABLE	HW SMOOTH	HW GRANULE FR

CONTINUED ON NEXT PAGE

THREE (3) PLY SBS HEAT-WELDED SYSTEM NAILABLE DECK (CONTINUED)



20-YEAR DIAMOND PLEDGE™ AND SYSTEM PLEDGE™ GUARANTEES

SPEC#	BOTTOM SHEET			
	ATTACHMENT	BASE SHEET	INTERPLY	CAP
N-1-2-25/HGP	NAIL	#75 BASE SHEET	HW 25 SMOOTH	HW PLUS GRANULE
	NAIL	#80 ULTIMA™ BASE SHEET	HW 25 SMOOTH	HW PLUS GRANULE
	NAIL	STRATAVENT® NAILABLE	HW 25 SMOOTH	HW PLUS GRANULE
N-1-2-25/HGPFRR	NAIL	#75 BASE SHEET	HW 25 SMOOTH	HW PLUS GRANULE FR
	NAIL	#80 ULTIMA™ BASE SHEET	HW 25 SMOOTH	HW PLUS GRANULE FR
	NAIL	STRATAVENT® NAILABLE	HW 25 SMOOTH	HW PLUS GRANULE FR
N-1-2-25/HGPFREC	NAIL	#75 BASE SHEET	HW 25 SMOOTH	ENERGYCAP™ SBS HEAT-WELD PLUS FR
	NAIL	#80 ULTIMA™ BASE SHEET	HW 25 SMOOTH	ENERGYCAP™ SBS HEAT-WELD PLUS FR
	NAIL	STRATAVENT® NAILABLE	HW 25 SMOOTH	ENERGYCAP™ SBS HEAT-WELD PLUS FR
N-1-2-HGP	NAIL	#75 BASE SHEET	HW SMOOTH	HW PLUS GRANULE
	NAIL	#80 ULTIMA™ BASE SHEET	HW SMOOTH	HW PLUS GRANULE
	NAIL	STRATAVENT® NAILABLE	HW SMOOTH	HW PLUS GRANULE
N-1-2-HGPFRR	NAIL	#75 BASE SHEET	HW SMOOTH	HW PLUS GRANULE FR
	NAIL	#80 ULTIMA™ BASE SHEET	HW SMOOTH	HW PLUS GRANULE FR
	NAIL	STRATAVENT® NAILABLE	HW SMOOTH	HW PLUS GRANULE FR
N-1-2-HGPFREC	NAIL	#75 BASE SHEET	HW SMOOTH	ENERGYCAP™ SBS HEAT-WELD PLUS FR
	NAIL	#80 ULTIMA™ BASE SHEET	HW SMOOTH	ENERGYCAP™ SBS HEAT-WELD PLUS FR
	NAIL	STRATAVENT® NAILABLE	HW SMOOTH	ENERGYCAP™ SBS HEAT-WELD PLUS FR



THREE (3) PLY SBS HEAT-WELDED NAILABLE DECK

HW-109

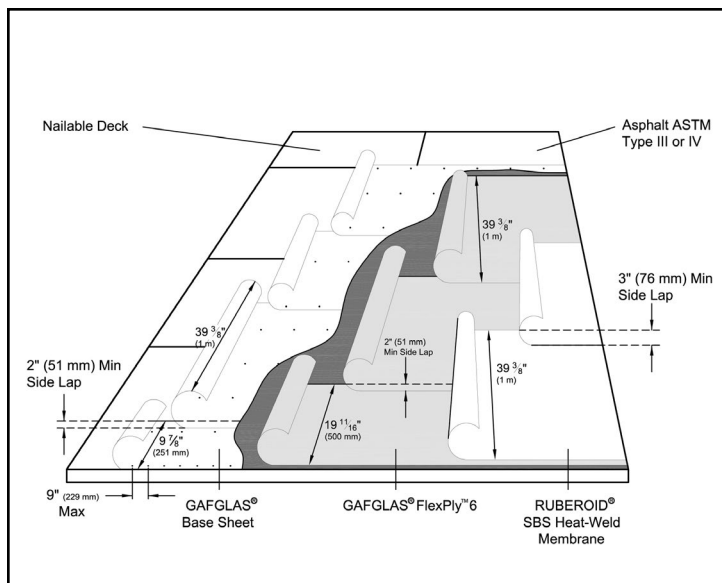

GENERAL

Safety: Refer to Section 1.06.
DO NOT BEGIN INSTALLATION UNTIL THIS INFORMATION IS READ, UNDERSTOOD, AND IMPLEMENTED.

MATERIALS

Material Requirements per 100 sq. ft. (9.29 m²):
Asphalt (per ply).....25 lb. (1.22 kg/m²)
Base Sheet1 ply
Interply1 ply
Membrane1 ply

15-YEAR DIAMOND PLEDGE™ AND SYSTEM PLEDGE™ GUARANTEES

SPEC#	BOTTOM SHEET ATTACHMENT	BASE SHEET	INTERPLY	CAP
N-2-1-HGP	NAIL	#75 BASE SHEET	FLEXPPLY™ 6	HW PLUS GRANULE
	NAIL	#80 ULTIMA™ BASE SHEET	FLEXPPLY™ 6	HW PLUS GRANULE
	NAIL	STRATAVENT® NAILABLE	FLEXPPLY™ 6	HW PLUS GRANULE
N-2-1-HGPFR	NAIL	#75 BASE SHEET	FLEXPPLY™ 6	HW PLUS GRANULE FR
	NAIL	#80 ULTIMA™ BASE SHEET	FLEXPPLY™ 6	HW PLUS GRANULE FR
	NAIL	STRATAVENT® NAILABLE	FLEXPPLY™ 6	HW PLUS GRANULE FR
N-2-1-HGPFREC	NAIL	#75 BASE SHEET	FLEXPPLY™ 6	ENERGYCAP™ SBS HEAT-WELD PLUS FR
	NAIL	#80 ULTIMA™ BASE SHEET	FLEXPPLY™ 6	ENERGYCAP™ SBS HEAT-WELD PLUS FR
	NAIL	STRATAVENT® NAILABLE	FLEXPPLY™ 6	ENERGYCAP™ SBS HEAT-WELD PLUS FR



FOUR (4) PLY SBS HEAT-WELDED SYSTEM NAILABLE DECK

HW-110

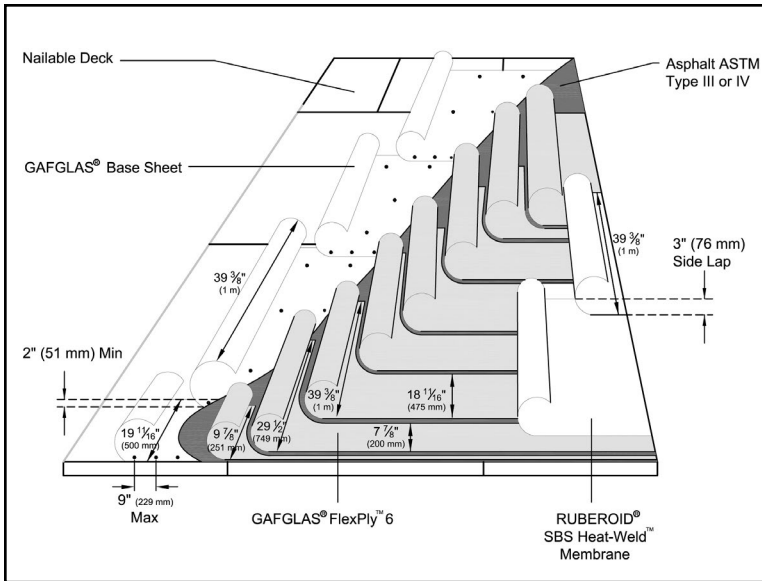

GENERAL

Safety: Refer to Section 1.06.
DO NOT BEGIN INSTALLATION
UNTIL THIS INFORMATION IS READ,
UNDERSTOOD, AND IMPLEMENTED.

MATERIALS

Material Requirements per 100 sq. ft.
(9.29 m²):
Asphalt (per ply).....25 lb. (1.22 kg/m²)
Base Sheet1 ply
Interply2 plies
Membrane1 ply

20-YEAR DIAMOND PLEDGE™ AND SYSTEM PLEDGE™ GUARANTEES

SPEC#	BOTTOM SHEET				
	ATTACHMENT	BASE SHEET	INTERPLY	INTERPLY	CAP
N-3-1-HGP	NAIL	#75 BASE SHEET	FLEXPLY™ 6	FLEXPLY™ 6	HW PLUS GRANULE
	NAIL	#80 ULTIMA™ BASE SHEET	FLEXPLY™ 6	FLEXPLY™ 6	HW PLUS GRANULE
	NAIL	STRATAVENT® NAILABLE	FLEXPLY™ 6	FLEXPLY™ 6	HW PLUS GRANULE
N-3-1-HGPFR	NAIL	#75 BASE SHEET	FLEXPLY™ 6	FLEXPLY™ 6	HW PLUS GRANULE FR
	NAIL	#80 ULTIMA™ BASE SHEET	FLEXPLY™ 6	FLEXPLY™ 6	HW PLUS GRANULE FR
	NAIL	STRATAVENT® NAILABLE	FLEXPLY™ 6	FLEXPLY™ 6	HW PLUS GRANULE FR
N-3-1-HGPFREC	NAIL	#75 BASE SHEET	FLEXPLY™ 6	FLEXPLY™ 6	ENERGYCAP™ HW PLUS GRANULE FR
	NAIL	#80 ULTIMA™ BASE SHEET	FLEXPLY™ 6	FLEXPLY™ 6	ENERGYCAP™ HW PLUS GRANULE FR
	NAIL	STRATAVENT® NAILABLE	FLEXPLY™ 6	FLEXPLY™ 6	ENERGYCAP™ HW PLUS GRANULE FR



TWO (2) PLY SBS HEAT-WELDED SYSTEM LIGHTWEIGHT INSULATING CONCRETE

HW-111

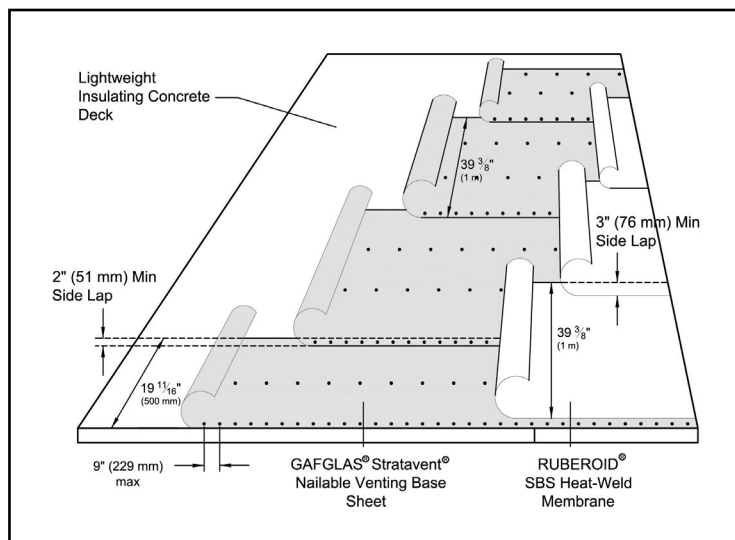

GENERAL

Safety: Refer to Section 1.06.
DO NOT BEGIN INSTALLATION
UNTIL THIS INFORMATION IS READ,
UNDERSTOOD, AND IMPLEMENTED.

MATERIALS

Material Requirements per 100 sq. ft.
(9.29 m²):
Base Sheet1 ply
Membrane1 ply

12-YEAR DIAMOND PLEDGE™ AND SYSTEM PLEDGE™ GUARANTEES

<u>SPEC#</u>	<u>BOTTOM SHEET ATTACHMENT</u>	<u>BASE SHEET</u>	<u>CAP</u>
N-1-1-HG	FASTENER	STRATAVENT® NAILABLE	HW GRANULE
N-1-1-HGFR	FASTENER	STRATAVENT® NAILABLE	HW GRANULE FR



THREE (3) PLY SBS HEAT-WELDED SYSTEM LIGHTWEIGHT INSULATING CONCRETE

HW-112

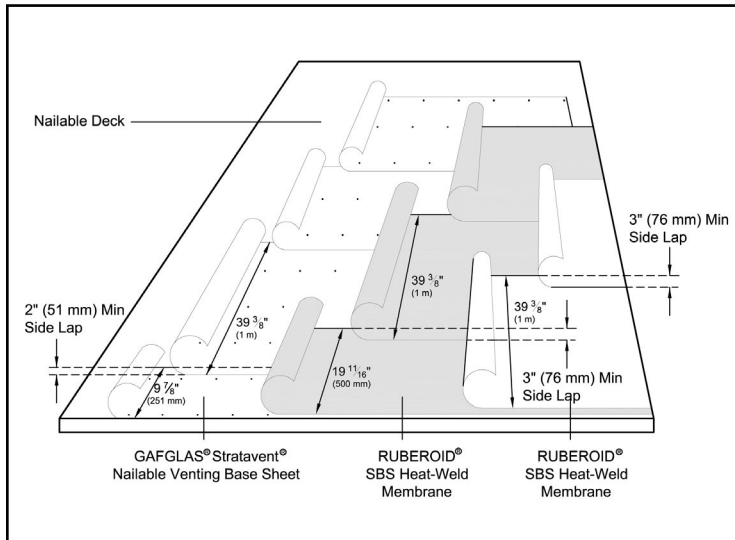

GENERAL

Safety: Refer to Section 1.06.
DO NOT BEGIN INSTALLATION
UNTIL THIS INFORMATION IS READ,
UNDERSTOOD, AND IMPLEMENTED.

MATERIALS

Material Requirements per 100 sq. ft.
(9.29 m²):

- Base Sheet1 ply
- Interply1 ply
- Membrane1 ply

15-YEAR DIAMOND PLEDGE™ AND SYSTEM PLEDGE™ GUARANTEES

SPEC#	BOTTOM SHEET			
	ATTACHMENT	BASE SHEET	INTERPLY	CAP
N-1-2-25/HG	FASTENER	STRATAVENT® NAILABLE	HW 25 SMOOTH	HW GRANULE
N-1-2-25/HGPF	FASTENER	STRATAVENT® NAILABLE	HW 25 SMOOTH	HW PLUS GRANULE FR
N-1-2-HG	FASTENER	STRATAVENT® NAILABLE	HW SMOOTH	HW GRANULE
N-1-2-HGFR	FASTENER	STRATAVENT® NAILABLE	HW SMOOTH	HW GRANULE FR

20-YEAR DIAMOND PLEDGE™ AND SYSTEM PLEDGE™ GUARANTEES

SPEC#	BOTTOM SHEET			
	ATTACHMENT	BASE SHEET	INTERPLY	CAP
N-1-2-25/HGP	FASTENER	STRATAVENT® NAILABLE	HW 25 SMOOTH	HW PLUS GRANULE
N-1-2-25/HGPF	FASTENER	STRATAVENT® NAILABLE	HW 25 SMOOTH	HW PLUS GRANULE FR
N-1-2-25/HGPFREC	FASTENER	STRATAVENT® NAILABLE	HW 25 SMOOTH	ENERGYCAP™ HW PLUS GRANULE FR
N-1-2-HGP	FASTENER	STRATAVENT® NAILABLE	HW SMOOTH	HW PLUS GRANULE
N-1-2-HGPF	FASTENER	STRATAVENT® NAILABLE	HW SMOOTH	HW PLUS GRANULE FR
N-1-2-HGPFREC	FASTENER	STRATAVENT® NAILABLE	HW SMOOTH	ENERGYCAP™ HW PLUS GRANULE FR



THREE (3) PLY SBS HEAT-WELDED LIGHTWEIGHT INSULATING CONCRETE

HW-113

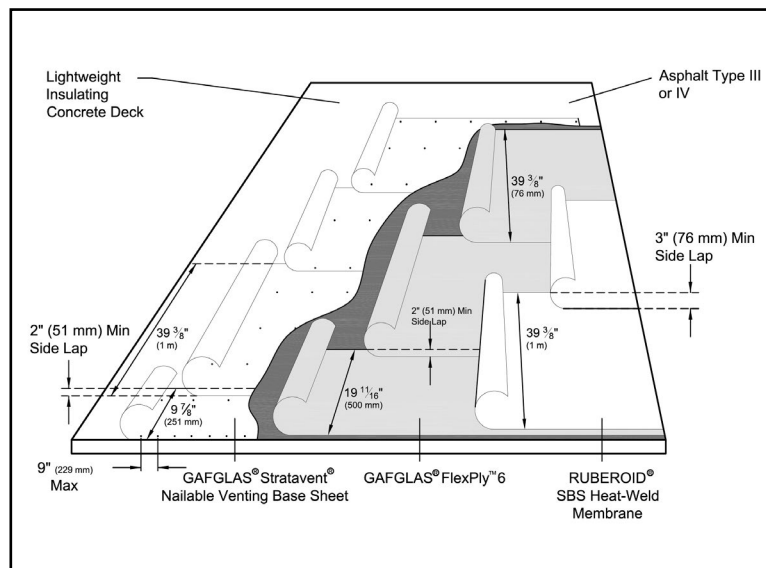

GENERAL

Safety: Refer to Section 1.06.
DO NOT BEGIN INSTALLATION
UNTIL THIS INFORMATION IS READ,
UNDERSTOOD, AND IMPLEMENTED.

MATERIALS

Material Requirements per 100 sq. ft.
(9.29 m²):
Asphalt (per ply).....25 lbs. (1.22 kg/m²)
Base Sheet1 ply
Interply1 ply
Membrane1 ply

15-YEAR DIAMOND PLEDGE™ AND SYSTEM PLEDGE™ GUARANTEES

	BOTTOM SHEET			
SPEC#	ATTACHMENT	BASE SHEET	INTERPLY	CAP
N-2-1-HGP	FASTENER	STRATAVENT® NAILABLE	FLEXPly™ 6	HW PLUS GRANULE
N-2-1-HGPFRR	FASTENER	STRATAVENT® NAILABLE	FLEXPly™ 6	HW PLUS GRANULE FR
N-2-1-HGPFREC	FASTENER	STRATAVENT® NAILABLE	FLEXPly™ 6	ENERGYCAP™ HW PLUS GRANULE FR

System Configurations



FOUR (4) PLY SBS HEAT-WELDED SYSTEM LIGHTWEIGHT INSULATING CONCRETE

HW-114

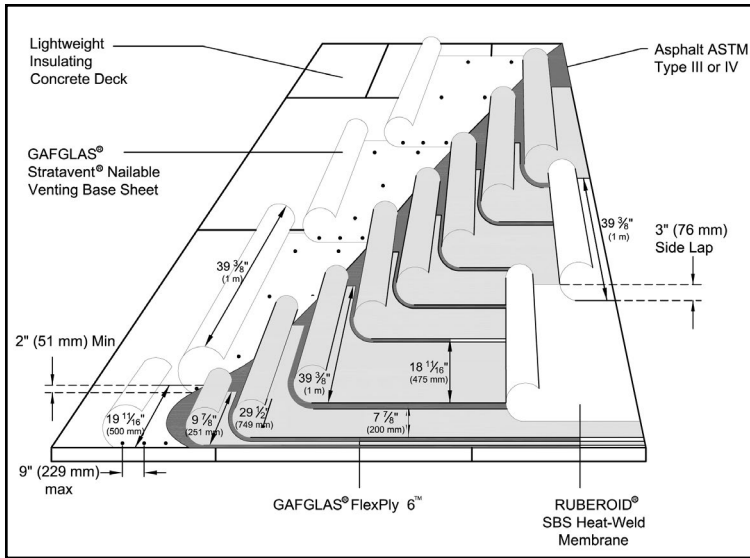

GENERAL

**Safety: Refer to Section 1.06.
DO NOT BEGIN INSTALLATION
UNTIL THIS INFORMATION IS READ,
UNDERSTOOD, AND IMPLEMENTED.**

MATERIALS

Material Requirements per 100 sq. ft. (9.29 m²):
 Asphalt (per ply).....25 lbs. (1.22 kg/m²)
 Base Sheet1 ply
 Interply2 plies
 Membrane1 ply

20-YEAR DIAMOND PLEDGE™ AND SYSTEM PLEDGE™ GUARANTEES

SPEC#	BOTTOM SHEET				
	ATTACHMENT	BASE SHEET	INTERPLY	INTERPLY	CAP
N-3-1-HGP	FASTENER	STRATAVENT® NAILABLE	FLEXPly™ 6	FLEXPly™ 6	HW PLUS GRANULE
N-3-1-HGPFRR	FASTENER	STRATAVENT® NAILABLE	FLEXPly™ 6	FLEXPly™ 6	HW PLUS GRANULE FR
N-3-1-HGPFREC	FASTENER	STRATAVENT® NAILABLE	FLEXPly™ 6	FLEXPly™ 6	ENERGYCAP™ HW PLUS GRANULE FR

NOTES

General Installation Requirements:

Part 1 – General

1.01 Work Conditions

- A. Work shall only begin when the contractor has decided, to his/her satisfaction, that all specifications are workable as specified, and that the contractor can meet project and code requirements.
- B. The contractor shall only begin roofing work when the substrates have been prepared as necessary, and are ready and acceptable to have materials installed as specified.
- C. Do not begin work when inclement weather is forecast to occur prior to the anticipated time of completion of the work item.
- D. Do not install materials during inclement weather, except for temporary work necessary to protect materials that are already installed. Remove all temporary work before installing permanent materials.
- E. Do not install materials when moisture, in any form, is present on the roof deck or substrate to which the materials are to be applied, or when foaming of hot asphalt occurs.
- F. Protect the building, contents, surrounding area, building occupants, and contractor personnel during work. Coordinate all work operations with the building owner and building occupants so that adequate interior protection, as necessary, is provided and disruption to normal building operations is minimized.

Provide adequate exterior protection to prevent damage to the building owner's property.
- G. Roof-system installation should not begin until all roof openings, curbs, pipes, sleeves, ducts, vents, or other penetrations through the roof are solidly set, and all tapered edges and cant strips, reglets, and wood nailers are secure and tight to the building as per this Manual.
- H. Where wheeled or other traffic over the partially completed roofing is unavoidable, provide and use adequate plank or plywood, set over a minimum thickness of rigid board insulation to protect the newly installed roof.
- I. Provide temporary water cut-offs and tie-ins at the end of each work day. Remove all temporary work at the beginning of the next work day.
- J. When tearing off an existing membrane, limit removal to the area that will be completely reroofed that day with the new roofing system.
- K. If conditions are uncovered or created that would be detrimental to the proper conduct of specified work, immediately notify the building owner and GAF of these conditions for consultation on acceptable treatments.
- L. Observe fire and safety precautions as recommended by Asphalt Roofing Manufacturers Association, the National Roofing Contractors Association, OSHA, and this Manual.
- M. Perform all work in compliance with local code requirements.
- N. Proper and adequate roof drainage is required and is the responsibility of those involved in the design and construction of the roof substrate and supporting structure. GAF recommends at least $\frac{1}{4}$:12 of slope with proper grading and placement of outlets. Guarantees will not be valid for areas of a roof that pond water. "Ponding" is defined as water that does not drain or dissipate from the roof surface within 48 hours after precipitation ends. Ponding can also result from other water sources, including improperly piped air-conditioning condensate and steam condensate lines.

1.02 Pre-Job Conference

- A. Potential problems in the application of roofing membranes are best discussed and potential conditions that may be detrimental to installation and performance of the roof system should be resolved prior to the start of the application. This can best be accomplished by a pre-job meeting with the architect, roofing contractor, general contractor, all other subcontractors whose work will involve the roof system/related systems, and the manufacturer's representative.
- B. The following are common items of discussion at a pre-job conference:
 - 1. Roof deck conditions.
 - 2. Flashing and expansion joint details.
 - 3. Insurance underwriters or building code requirements.
 - 4. Unusual project conditions.
 - 5. Protection of the roof, building, building occupants, and contents during and after application.
 - 6. Application techniques.
 - 7. Coordination and scheduling of other trades who will be working on the project.
 - 8. Designation by the roofing contractor of a qualified person responsible for quality control. This person shall be on the project full-time during application of the roof system, and shall not be changed without the approval of GAF.
 - 9. Scheduling of material shipments, material storage, and rooftop loading.
 - 10. Submittals of materials, drawings, and project documents.

1.03 Delivery, Storage, and Handling

- A. GAF roofing materials leave the factory dry and must be stored to prevent the materials from getting wet.
- B. Unload and handle all roofing and construction materials with care.
- C. Examine all materials as they are received. Do not use any materials that are damaged, unlabeled, or otherwise appear to be unfit for use.

Materials must display legible labels, which identify the materials and applicable reference standards.

Immediately notify carrier and GAF or other manufacturer of damaged, wet, or defective materials. GAF will not accept responsibility for damage to its roofing materials after the materials have been released from GAF manufacturing or warehousing facilities.

- D. Do not expose materials to moisture in any form before, during, or after delivery to the site. Reject delivery of materials that show evidence of contact with moisture.
- E. At the job site, no more material should be stored than what will be used within two weeks. For periods longer than two weeks, the materials should be properly warehoused, i.e., dry, ventilated, on pallets, etc. No more material should be stored on the roof than can be used within five days. When prolonged inclement weather threatens, i.e., rainy seasons, no more roofing materials should be supplied to the rooftop than can be used within two days.

- F. Store roll goods on end on pallets in a clean, dry, well-ventilated, protected area. Take care to prevent damage to roll ends or edges. Do not double-stack modified bitumen products.
- G. Remove manufacturer-supplied plastic covers from materials provided with such covers. Use “breathable” type covers such as canvas tarpaulins to allow venting and protection from weather and moisture. Cover and protect materials at the end of each day’s work. Do not remove any protective tarpaulins until immediately before material will be installed.
- H. Insulation products should be properly stored and weighted to avoid weather and wind damage.
- I. Store roofing asphalt to prevent leakage and carton deterioration.
- J. Store all adhesives, coatings, and sealants/caulks to protect from freezing. Frozen material must be discarded and replaced. Properly seal all liquid material containers after use.
- K. Store materials above 55°F (12.8°C) a minimum of 24 hours prior to application.
- L. Follow the requirements indicated in Part 11 when applying GAF membranes at temperatures below 45°F (7.2°C). Do not install Matrix™ cold adhesives when temperatures fall below 45°F (7.2°C) or when inclement weather threatens.
- M. In the unlikely event that obviously defective or damaged material reaches the job site or damage to the material occurs from improper storage on the job site, it is the responsibility of the roofing contractor not to install this material. Notify GAF immediately about material that has apparent manufacturing defects. Installation of defective material can result in additional costs above the cost of supplying replacement material. If the roofing contractor chooses to install material with apparent defects, this added cost is not the responsibility of GAF.

1.04 Regulatory Requirements

- A. Conform to all applicable building and jurisdictional codes, including roof assembly, wind uplift, and fire-resistance requirements.

1.05 Quality Control of Application

- A. GAF recognizes the crucial role of workmanship in the construction of a reliable roofing membrane designed to perform for its anticipated service life. Material delivery, storage and handling, and control over material application procedures are also of great importance.
- B. There are recommendations and requirements that must be considered in the roof system construction process. They include, but are not limited to, the following:
 1. GAF recommends that the contractors develop and present a verifiable in-house contractor quality control program to the building owner, which can be followed during the construction of GAF roof systems.
 2. Visual inspection should be of the following: deck surface; specified materials being installed; use of the proper adhesive and bitumen types; conditions of the materials being installed; use of proper and specified number of fasteners (if required); use of the correct number of plies and the correct application procedure; and surfacing.
 3. Periodic checks of the asphalt temperatures at all phases of the application.
 4. Architect, owner, and contractor shall monitor progress of work for compliance to project specifications and drawings. Such monitoring minimizes the potential for problems, provides for easy resolution and correction of errors, provides participants with documentation of work

in place, and allows for inspection of work that cannot be examined by standard tests, such as flashing and sheet metal installations. Architect, owner, and general and roofing contractors are responsible for meeting insurance and/or code requirements.

5. Roofing products and other associated roof system materials shall be installed according to the minimum guidelines set forth in this Manual and to individual project requirements.
 6. Careful visual examination of all side, end, and T-laps of each ply of membrane for proper adhesion.
- C. Contact GAF at 1-800-766-3411 for further information about quality control concerns.

1.06 Safety Considerations and Warnings

A. General

Installation of a roof system is a construction process. As with any construction process, safety is a key element. All applicable safety standards and good roofing practices must be followed. Fire prevention is the applicator's responsibility.

B. Warning

PRODUCTS MAY CONTAIN ONE OR MORE OF THE FOLLOWING HAZARDOUS SUBSTANCES, WHICH CAN CAUSE CANCER AND/OR SERIOUS AND PERMANENT LUNG DAMAGE: OXIDIZED ASPHALT, SILICA, AND TITANIUM DIOXIDE. WEAR APPROPRIATE PROTECTIVE CLOTHING AND FOLLOW RECOMMENDED WORK PRACTICES WHEN USING, HANDLING, OR DISPOSING OF THESE PRODUCTS. FOR ADDITIONAL INFORMATION, READ THE SAFETY DATA SHEET FOR EACH PRODUCT.

APPLICATION/USE OF THESE PRODUCTS MAY RESULT IN BURNS AND/OR OTHER PHYSICAL INJURY. SURFACES THAT COME IN CONTACT WITH THE MOLTEN PRODUCT MAY BECOME INFLAMED. CONTACT WITH MOLTEN ASPHALT MAY CAUSE BURNS.
Statement of Practical Treatment: In case of skin contact with molten bitumen, apply ice or other cold liquid compatible with skin. Get medical attention immediately.

C. General Precautions

1. READ AND UNDERSTAND GAF'S SPECIFICATION MANUAL before starting application. Follow all precautions and directions.
2. THOROUGHLY TRAIN ALL PERSONNEL IN THE RECOMMENDED SAFETY PROCEDURES for use of kettles, asphalt mopping, and propane torches, and for application of product.
3. ONLY PROPERLY TRAINED AND PROFESSIONALLY EQUIPPED ROOFING CONTRACTORS experienced in the installation of each roofing technology, i.e., hot-asphalt applied, torch-applied, cold-applied, or self-adhered, should install these systems.
4. FIRE PREVENTION INSPECTIONS should be conducted periodically during installation, with a final inspection being conducted upon completion of that day's work.
5. THOROUGHLY TRAIN ALL PERSONNEL IN PREVENTING AND EXTINGUISHING FIRES.
6. NEVER ALLOW CONTACT between the heated surface of the product, hot asphalt, or open flame and hair, skin, or clothing.
7. WEAR PERSONAL PROTECTIVE GEAR. Always use appropriate safety hardhat, goggles, heavy-duty gloves, snug-fitting clothing (long pants and long-sleeved shirt), and boots.

8. SOLVENT-CONTAINING CEMENTS AND COATINGS ARE COMBUSTIBLE AND SHOULD ALWAYS BE KEPT AWAY FROM HEAT, OPEN FLAME, OR ANY SOURCE OF IGNITION. Empty containers must be disposed in posted toxic substance landfills in accordance with local, state, and federal regulations.
 9. WHEN WORKING WITH SOLVENT-CONTAINING CEMENTS AND COATINGS, AVOID DIRECT CONTACT AND ENSURE ADEQUATE VENTILATION. Wear appropriate protective equipment. Refer to product Safety Data Sheet (SDS) for additional information.
 10. THOROUGHLY TRAIN ALL PERSONNEL IN FIRST-AID PROCEDURES.
 11. ALWAYS COMPLY WITH ALL OSHA SAFETY STANDARDS AND FIRE CODES.
 12. NEVER APPLY built-up or modified bitumen products DIRECTLY OVER EXPOSED CONDUITS OR PIPES LYING ON THE ROOF DECK.
 13. USE EXTREME CAUTION when working around equipment that has electrical and/or gas connections, such as gas lines or HVAC units.
- D. Cold Applied Systems and Flashings – Solvent Vapor Control
1. Various Matrix™ adhesives and flashing cements are solvent-based and do have an odor. These products will emit solvent odor during application and afterward until fully cured and set up. Cure times can vary widely according to factors such as type of system installed, local weather, and ambient temperatures. The roofing contractor and project designer must take precautions to minimize solvent-odor penetration into occupied building spaces. Air intakes near the roof should be closed. Ductwork, equipment curbs, HVAC equipment, and other penetrations should be checked for entry sources.
 2. On wood decks, a minimum 6 mil. (.15 mm) thick polyethylene sheet is required to be installed directly on the deck to minimize potential odors entering the building during roof installation and during the cure time. Air barriers should be enveloped and sealed at penetrations, perimeters, and other roof terminations. (CAUTION: polyethylene can be slippery. Until a base sheet can be securely nailed or insulation can be mechanically attached, be careful when walking on the polyethylene to prevent slipping and falling.)
 3. Cold-applied roof systems should not be used in situations where the underside of the roof deck is used as the top of a plenum of a HVAC system. This type of system is susceptible to solvent odor migrating through the deck and into the plenum space until the adhesives are fully cured.
- E. Torch Safety Information
1. Installation of torch-applied products creates the risk of fire, including smoldering fires. Torch-applied products must be applied **only** by professional roofing applicators trained in proper torch application and safety procedures. Contractors can obtain certification through The Certified Roofing Torch Application program administered by NRCA. Information is available at www.nrca.net. Roof applicators must follow GAF's current roofing safety requirements, procedures, and specifications, which are available from GAF Technical Services toll-free: 1-800-766-3411.
 2. Procedures and equipment that will be used must comply with all applicable code requirements. Knowledge of the building construction and HVAC systems must be obtained prior to the installation of torch-applied products.

3. Identify all potentially combustible and flammable aspects of the building's use and design that increase the risk of fire, including:
 - Deck and under deck composition (materials and accessories)
 - Insulation types
 - Cants and tapered-edge strips
 - Parapet wall and curb composition
 - Perimeter details
 - Adjoining building materials
 - Expansion joints
 - Wires and electrical conduit pipes
 - Natural gas lines
 - Chemicals, grease, oils, and other condensates/exhausts/spills
 - Restaurant and food service exhaust vents can contain grease. All intake fans should be shut off during application with special care to keep open flame away from openings and vents. Exhaust fans for laundromats in commercial, institutional structures, and residential condominiums, apartments, or other multiple-tenant occupied dwellings must be shut off as they can contain lint and debris.
4. A fiberglass base sheet must be used between the roofing membrane and any combustible materials, such as wood. Repair any damaged or torn base sheets before torch-welding begins. Combustible materials, substrates, and adjoining building surfaces that cannot be removed from torch-welding area must be protected. Never apply flame directly to combustible materials or allow the flame to enter into hidden or protected areas that may contain combustible materials such as:
 - Air intakes or exhaust openings
 - Air coolers and A.C. units
 - Lead flashings
 - Drains
 - Counterflashings and coping covers
 - Collars
 - Flashings
5. The installation equipment must be designed for the specific use, and must be in proper working order. Follow the manufacturer's safety and operating instructions for all torching equipment. Check all fittings and other equipment for leakage. Never use a flame to check fittings and other equipment. Ventilation must always meet or exceed OSHA or NIOSH requirements.
6. A supervisor trained in torch safety must conduct external and internal fire watches during application and after the torches are shut down. Infrared scanning equipment must be used in the fire watch. The watches shall **never** be less than one hour and may need to be longer. The watches shall be of sufficient frequency and duration based on:
 - Weather
 - Building and roof design and composition
 - Penetration types and design
7. One Class ABC fire extinguisher must be kept within 10 feet (3.05 m) of every torch operator. In addition, buckets of sand and pails of water are recommended as supplemental fire-extinguishing materials. Portable fire extinguishers must be of a size and type required by local codes; however, extinguishers less than a 20 lb. (9.1 kg) minimum size are not recommended. Fire extinguishers must be checked prior to each day's work to make sure they are full and operable.

The above list is not a complete list of necessary safety requirements, procedures, and specifications. Call GAF Technical Services Helpline for the most current technical literature. In addition, the following steps must be taken by the applicator to prevent fires, since only the applicator is in a position to prevent fires. These steps include, but are not limited to:

- Do not leave propane torches lighted and unattended. Do not place a lighted torch on the deck surface, insulation, membrane, or any other surface or object other than an acceptable torch stand.
- Extinguish the torch when not in use.
- Avoid holding the flame on any one area of the membrane or substrate long enough for heavy smoke to be generated.
- Train all personnel in GAF-recommended application techniques.
- Torch operators must maintain awareness of other personnel in the torch-welding area. In tight quarters, only one torch should be used.
- Train all personnel in fire prevention and extinguishing methods.
- Take precautions when working around combustible materials, such as gas lines for HVAC units, and in the presence of solvent-based products. Remove all combustible debris, material wrappers, and trash from torch-welding area prior to installation. Use caution to prevent burns and train personnel in first-aid procedures.
- Comply with all applicable fire regulations regarding the storage and use of propane.

For more information on safety measures, refer to Factory Mutual Property Loss Prevention Data Sheet 1-33.

Part 2 – Inspection and Preparation of Surfaces

2.01 General

- A. Prepare substrate surfaces thoroughly prior to application of new roofing materials. This is particularly important for re-cover and reroofing applications. Providing a smooth, even, sound, clean, and dry substrate minimizes the likelihood that underlying deficiencies will cause premature deterioration or even failure of the new roofing system.

2.02 Roof Decks

- A. The surface of the deck must be dry, firm, smooth, and free of dirt and loose material. Electrical conduits, bolts, and other small items must be removed from the surface of the roof deck; such surface irregularities cannot be properly insulated and roofed. It is the responsibility of the roofing contractor, deck contractor, or owner's representative to determine the suitability of the roof deck surface to receive the roof assembly. The deck must meet GAF requirements as described in the Roof Design section of this Manual. None of the foregoing factors are the responsibility of GAF which under no circumstances will assume such responsibility.
- B. Perimeter and penetration wood nailers and curbs must be in place as specified.
- C. The roof deck must provide positive drainage or tapered insulation must be used to provide slope. Outlets must be placed and installed to remove water promptly and completely from the roof.
- D. Expansion joints, roof vents, roof drains, etc., must be installed using acceptable industry standards and GAF specifications and flashing details.

2.03 Re-cover Systems

- A. For re-cover specifications (installation of a new roofing system over an existing system), any additional surface preparation relative to inspection and treatment of defects in the existing roofing system must be conducted in accordance with good roofing practices. Preparation includes, but is not limited to, removal of existing flashings, replacement of wet/damaged existing roofing materials, removal of loose aggregate, removal of abandoned equipment, supports, and penetrations, replacement of damaged decking, etc. The substrate must present a suitable surface to receive and hold the new roofing materials. Also refer to GAF recommendations on reroofing in the Roof Design section of this manual.

Blisters, splits, and other membrane defects and deck deficiencies must be repaired, and wet insulation replaced, in accordance with good roofing practices to attain a surface that is smooth, dry, clean, and free of sharp projections and depressions.

- B. If the existing roof membrane is to remain on the roof and there is any doubt as to the adequacy of the attachment of the existing roof membrane, then the new roof membrane should be mechanically fastened through the existing roof to the deck. Stainless-steel fasteners are recommended when fastening through existing roof systems.
- C. A recovery board must be used over the old roof membrane. For existing gravel surfaced built-up roofing, power broom, spud if necessary, and remove all loose gravel to provide a smooth, level surface. Mechanically fasten cover board to deck.
- D. All existing composition and metal flashing must be removed and replaced.
- E. All existing metal counterflashing, metal coping, and other metal work above the roof system must be inspected and replaced or repaired as necessary to provide a watertight assembly.
- F. All metal flashing must be primed with Matrix™ 307 Premium Asphalt Primer where it will come in contact with the GAF membrane.
- G. Inspect roof drains and outlets. Remove existing drain flashings and replace broken or stripped bolts, clamping rings, and strainers. Drains must be M-Weld™ drains or drains with metal-type clamping rings. Plastic drains are not acceptable. All drains, including retrofit or insert drains, must be sumped to promptly remove water from the roof surface.
- H. M-Weld™ One-Way Moisture Vents must be used when re-covering. Install a minimum 4" (102 mm) diameter one-way pressure-relief vent every 10 squares (92.9 m²). Cut 4" (102 mm) holes for one-way vents through the existing roof system to the deck. For roof areas where the minimum dimension does not exceed 60' (18.3 m), perimeter venting may be used in place of the one-way vents.
- I. If a vapor retarder exists, contact GAF Technical Services at 1-800-766-3411.
- J. When reroofing over an existing coal-tar roof system, a minimum 1" (25 mm) re-cover board is required over the existing system.
- K. All existing surfaces must be compatible with GAF roof systems. Prime all masonry, metal, and existing asphalt surfaces and substrate with Matrix™ 307 Premium Asphalt Primer where GAF membranes are to be adhered.
- L. Contact GAF at 1-800-766-3411 for requirements on individual projects and re-cover over non-asphaltic-based roofing systems.

2.04 Reroofing – Tear-off

- A. All old roofing must be removed down to the deck. The deck shall be cleaned, repaired, and otherwise conditioned to conform to the requirements of a new deck. Refer to the Roof Design section of this Manual.
- B. All old flashing must be removed and stripped from walls, curbs, etc.
- C. All existing composition and metal flashing must be removed and replaced.
- D. All existing metal counterflashing, metal coping, and other metal work above the roof system must be inspected and replaced or repaired as necessary to provide a watertight assembly.
- E. All metal flashing must be primed with Matrix™ 307 Premium Asphalt Primer where it will come in contact with the GAF membrane.
- F. Prime all masonry, metal, and existing asphalt surfaces and substrates with Matrix™ 307 Premium Asphalt Primer where GAF membranes are to be adhered.
- G. Inspect roof drains and outlets. Remove existing drain flashings and replace broken or stripped bolts, clamping rings, and strainers. Drains must be M-Weld™ drains or drains with metal-type clamping rings. Plastic drains are not acceptable. All drains, including retro fit or insert drains, must be sumped to promptly remove water from the roof surface and meet code requirements.

Note: Substrates must be inspected and accepted by the deck contractor, roof contractor, or owner as being ready to receive and hold the roof system as specified.

Part 3 – Asphalt

3.01 General

- A. Hot asphalt must be handled carefully. See Section 1.06, Safety Considerations and Warnings.
- B. Field experience has demonstrated that proper temperatures in the kettle and at the point of application are essential to obtain a satisfactory roof. Kettle temperatures in excess of those indicated (see Sections 3.03 and 3.04) may result in changes to the asphalt, while temperatures below specified minimums can result in lack of adhesion.
- C. Do not mix different types of asphalt.
- D. Take all necessary precautions to avoid asphalt drippage into the interior of a building. GAF will not be responsible for damage to the structure or interior because of asphalt drippage.
- E. Discontinue application of asphalt over any substrate where foaming of asphalt is observed.
- F. RUBEROID® Torch/Heat-Weld and self-adhered membranes must not be installed in moppings of hot asphalt.

3.02 Asphalt Type

- A. RUBEROID® SBS roof systems require use of ASTM D312, Type III or Type IV asphalt for interply moppings. Type IV asphalt is required on all slopes $\frac{1}{2}$:12 or greater for installation of vapor retarders, thermal insulation, roof system base plies, and RUBEROID® SBS hot-applied membranes.

- B. For GAFGLAS® built-up roof systems, ASTM D312, Type III or Type IV asphalt is required for installation of vapor retarders, thermal insulation, and all roof system plies. On slopes up to 1/2:12, ASTM Type I asphalt may be used for a surface coating when applied as a glaze coat (15 lbs. per 100 square feet [0.7 kg/m²] plus or minus 20%) in accordance with GAF specifications. Type IV asphalt is required on all slopes above 3:12 for all system components.
- C. Only use asphalt manufactured in the United States or Canada, unless otherwise approved in writing by GAF Technical Services.

3.03 Asphalt Application Rate

- A. Application with hot asphalt requires continuous, uniform interply moppings of 25 lbs ± 20% per 100 square feet of roof area (1.2 kg/m²). During installation, a rolling bank (small puddle) of mopping asphalt should be maintained across the full width of the roll. Too little asphalt may result in voids, while too much asphalt can result in membrane slippage.
- B. When applying non-modified fiberglass base or fiberglass interply sheets, the point of application temperature of the asphalt must be at the Equiviscous Temperature (EVT) with a tolerance of ± 25°F (±13.9°C) at which a viscosity of 125 centistokes is attained. When using mechanical asphalt applicators, the target viscosity should be 75 centistokes.
- C. For all SBS modified asphalt membranes, the minimum point of application temperature of the asphalt must be at the EVT or 425°F (218°C), whichever is greater. When heating, do not exceed 550°F (288°C).
- D. The equiviscous temperature (EVT) for the asphalt can be found on the asphalt cartons or bills of lading.
- E. For substrates that absorb asphalt, apply the asphalt in sufficient quantity to ensure the level of adhesion specified.
- F. Asphalt application shall not commence when the outside temperature is below 45°F (7.2°C) unless cold-weather application instructions are followed. See Part 11.
- G. In cold weather, insulated piping and ladders may be necessary to maintain the required asphalt temperature at the point of application.

Asphalt Application Chart

Asphalt Type	Uses	Application Rate ¹	Max. Slope ²	Zone	Application Temperature ³
Type I	Glaze Coat	15 lbs./sq. (0.7 kg/m ²)	1/2:12	North & South	EVT ± 25°F (± 13.9°C)
Type II	Flood Coat Interply	60 lbs./sq. (2.9 kg/m ²) 25 lbs./sq. (1.2 kg/m ²)	1/2:12	All ⁵	EVT ± 25°F (± 13.9°C)
Type III	Flood Coat Interply	60 lbs./sq. (2.9 kg/m ²) 25 lbs./sq. (1.2 kg/m ²)	3:12	All	EVT ± 25°F (± 13.9°C)
Type IV	Flood Coat Interply	60 lbs./sq. (2.9 kg/m ²) 25 lbs./sq. (1.2 kg/m ²)	6:12	All	EVT ± 25°F (± 13.9°C)

Asphalt Application Chart continued on next page

Asphalt Application Chart (continued)

Refer to individual Roof System Requirements sections for allowable asphalt types and specified uses.

1. Plus or minus 20% per 100 square feet (9.29 m²) of roof area.
2. Refer to Part 6, Steep-Slope Requirements, for additional limitations on asphalt type and maximum allowable deck slope for individual system applications.
3. For non-modified base, ply, and cap sheets, the point of application temperature must be at the Equiviscous Temperature (EVT) $\pm 25^{\circ}\text{F}$ ($\pm 13.9^{\circ}\text{C}$) at which a viscosity of 125 centistokes is attained. Target viscosity for mechanical applicators should be 75 centistokes. For all SBS modified asphalt membranes, the minimum point of application temperature must be EVT or 425°F (218°C), whichever is greater. When heating, do not exceed 550°F (288°C).
4. Except Florida, Texas, New Mexico, Arizona, and California.

3.04 Asphalt Heating

- A. The operator of the roofing bitumen kettle must be fully trained and familiar with its safe operation, and have the required safety equipment and clothing for their protection.
- B. Never leave the roofing bitumen kettle unattended while operating.
- C. Accurate thermometers must be on the job site to check temperatures at the kettle and at point of application. Periodically verify asphalt temperatures with an accurate portable thermometer.
- D. Do not keep heated tankers above 325°F (163°C) overnight or weekends.
- E. The roofing bitumen kettle must be placed a safe distance from the building. It should be on plywood or a tarp to facilitate easy clean-up.
- F. Maximum Heating Temperature: In accordance with ASTM D312, the maximum heating temperature of any ASTM D312 asphalt is 550°F (288°C).

Part 4 – Fastening











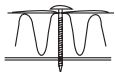



4.01 General

- A. GAF recommends the use of tools and equipment specifically designed for mechanically fastening roof materials to conform to requirements of the fastener manufacturer.
- B. Drive fasteners at an appropriate angle to ensure proper thread engagement and specified holding strength. Fasteners that are improperly installed shall be removed or corrected.
- C. Do not drive fasteners to the point where the stress plates cup and the insulation “dimples.” This is indicative of over-driving the fastener.
- D. Do not under-drive fasteners. Fasteners shall be properly seated against the stress plate with the plate set tight or locked into place against the insulation.

- E. Fasteners must be installed to secure the roof assembly to the structural substrate to provide a recommended minimum wind-uplift resistance equal to 60 psf (2.87 kN/m²) in the field of the roof. Where design requirements, local code, insurance, or other regulatory requirements dictate higher wind-resistance values, a design professional must advise of fastener type and density.
- F. Do not install fasteners into/through wet or deteriorated insulation and/or substrates.
- G. Stainless-steel fasteners are recommended when fastening through existing roof systems.
- H. Be sure to locate and identify electric or any other conduits in or under decks and/or walls before any drilling is performed.
- I. Fastener pull-out tests are required for poured lightweight insulating concrete, gypsum, and cementitious structural wood-fiber decks.
- J. Fastener pull-out tests are recommended for all deck types.
- K. Metal or plastic stress plates, minimum 3" (76 mm) in diameter, are required when mechanically attaching insulation or the base sheet and insulation simultaneously. Metal stress plates must be used for torch- or heat-weld applications.
- L. For additional fastening information, and for FM compliance, refer to Factory Mutual LPDS 1-28, 1-29, and 1-49; also refer to the Factory Mutual Approval Guide and GAF Factory Mutual Approval Reports for supplemental information.
- M. Refer to FM Global Loss Prevention Data Sheets for enhanced fastener density requirements at roof corners and perimeters.

4.02 Fastener Types

General Fastener Types		
Deck Type	Fastener Types	
	Base Sheet	Insulation
Steel		A
Wood	B,C	C
Concrete	D,E	D,E
Gypsum (Poured)	F,G,H,I,M	K,L
Gypsum (Plank)	F,G	K,L
Lightweight/Cellular Insul. Concrete	I	
Cementitious Structural Wood Fiber	G,J,K,M	K,L

A 	B 		C 	D 	E 	F 
Steel Fastener Self Tapping Screw	Capped Head Nail 1" dia. rnd. or sq.cap	Roofing Nail Annular Thread 3/8" dia. 11 ga.	Wood Fastener Self Tapping Screw min. 3" Plate	Concrete Fastener Nail-type (CD-10 Fastener)	Concrete Fastener Threaded min. 3" Plate	Hardened Split Shank Nail
G 	H 	I 	J 	K 	L 	M 
Tube Nail Two Piece 1" dia. cap	Hollow Cone Shank Fastener	LWIC Base Ply Fastener (or Base Sheet Fastener)	Self-Locking Fastener 1" dia. cap	Two Piece Nylon Screw and Plate	Two Piece Auger Type Steel Screw and Plate	Locking Impact Nail

GAF Specific Approved Fasteners (Note: letter designation corresponds to letter designations in the table/chart on previous page.)

- A. Drill-Tec™ Screw and Plate for steel. Carbon steel fastener with corrosion-resistant coating, self-tapping drill point, driven through a minimum 3" (76 mm) plate, or stainless-steel fastener, self-tapping, driven through a minimum 3" (76 mm) plate.
- B. Cap head nail – 1" (25 mm) diameter round or square cap, ring shank, or annular threaded. Roofing nail 3/8" (10 mm) diameter head/11-gauge, ring shank, or annular threaded; must be driven through minimum 1" (25 mm) round/square cap plate.
- C. Drill-Tec™ Screw and Plate for wood. Carbon steel fastener with corrosion-resistant coating, self-tapping, driven through a minimum 3" (76 mm) plate.
- D. Drill-Tec™ CD-10 Fastener – Nail-type fastener for concrete.
- E. Drill-Tec™ Screw and plate for concrete. Carbon steel fastener with corrosion-resistant coating, driven through a minimum 3" (76 mm) plate.
- F. Drill-Tec™ Hardened Split Shank Nail – when driven, shank spreads out to provide back-out resistance.
- G. Two-piece tube nail – 1" (25 mm) diameter cap; when driven, pin bends/hooks out to provide back-out resistance. Stress plates are optional.
- H. One-piece self-locking hollow cone shank fastener – electro-zinc galvanized tapered cone shank.
- I. Drill-Tec™ CR Base Sheet Fastener – when driven, electro-zinc galvanized shank spreads out to provide back-out resistance. Some installations may require fastener to be driven through 3" (76 mm) plate.
- J. Self-locking fastener – 1" (25 mm) diameter cap, when driven, shank spreads out to provide pullout resistance.
- K. Drill-Tec™ Nylon Screw and Plate – two-piece reinforced nylon screw and plate system with deep-slotted, self-locking thread design; with 3" (76 mm) metal plate.
- L. Drill-Tec™ Lite Deck Screw and Plate – two-piece auger-type coated screw and plate system with deep-slotted, self-locking thread design; with 3" (76 mm) metal plate.
- M. Drill-Tec™ Locking Impact Nail – 2.7" (6.9 mm) diameter disk fastener with integral tube and locking staple pin; when driven, dual wire legs diverge to provide back-out resistance.

4.03 Fastener Plates

Plate Type	Used For	Application/System
2" (51 mm) Flat Plate	Steep slope in-seam fastening	Liberty™
3" (76 mm) Flat Plate*	Insulation, Base Sheet	Liberty™, BUR & MB
3" (76 mm) Galvalume Steel Plate	Insulation, Base Sheet	Mop, Cold & Torch Systems
3" (76 mm) Plastic Locking Plate	Insulation, Base Sheet to Insulation	Mop and Cold-Applied Systems
3" (76 mm) Plastic Plate	Insulation	Mop and Cold-Applied Systems
3" (76 mm) NTB Plate Steel	Insulation	Mop, Cold & Torch Systems
3" (76 mm) NTB Plastic Plate	Insulation	Mop and Cold-Applied Systems
3" (76 mm) Lite-Deck Plate	Insulation	Mop, Cold & Torch Systems

* Required for simultaneous base-sheet fastening over wood, DensDeck®, SECUROCK®, or insulation.

Part 5 – Vapor Retarder Installation

5.01 General

- A. The best vapor retarder material cannot be effective in reducing transmission of moisture vapor if it is not properly installed or if it is damaged or punctured during application. Laps and joints must be properly sealed, projections extending through the vapor retarder must be flashed or enveloped at the vapor-retarder level to ensure integrity of the vapor retarder, and all punctures in the vapor retarder must be repaired prior to installation of the roof insulation. Insulation boards should be installed immediately over the vapor retarder to protect the vapor retarder from puncture or damage caused by subsequent construction traffic.
- B. When a vapor retarder is installed, allow for venting any trapped moisture between the vapor retarder and the roof membrane by using perimeter venting or using one-way vents placed one vent for every 1,000 square feet (9.29 m²), venting from the surface of the vapor retarder. When using isocyanurate insulation above a vapor retarder, GAF recommends GAFGLAS® Stratavent® Perforated Venting Base Sheet as the first ply over the isocyanurate insulation.
- C. Use of DensDeck® roof boards as the base layer of insulation directly below hot asphalt-applied vapor retarders requires the use of GAFGLAS® Stratavent® Perforated Venting Base Sheet as the first ply of the selected hot-mopped asphalt-applied vapor retarder assembly .
- D. Where vapor retarders are present, insulated roof assemblies using DensDeck®, DensDeck® Prime™, or SECUROCK® roof boards mopped in hot asphalt require use of GAFGLAS® Stratavent® Perforated Venting Base Sheet as the base ply in the selected GAF roof membrane. Cold-process roof membranes may not be installed directly to the DensDeck®, DensDeck® Prime, or SECUROCK® roof boards set in hot asphalt when vapor retarders are present. OlyBond 500® Adhesive Fastener may be used within selected roofing assemblies to install DensDeck® roof board or other EnergyGuard™ Polyiso or Fiberboard insulations. Refer to the DensDeck® Application Chart in the Roof Design/Insulation section of this Manual for additional information. Contact GAF Technical Services for additional requirements.

- E. The following is a list of acceptable vapor retarder systems:
1. Two plies of GAFGLAS® FlexPly™ 6 or Ply 4 felt.
 - a. Installed in hot asphalt over acceptable substrates.
 - b. Refer to the GAFGLAS® Built-Up Roofing Systems (BUR) Applications and Specifications Manual for felt installation requirements.
 2. One or more plies of RUBEROID® 20 Smooth.
 - a. Installed in hot asphalt over acceptable substrates.
 - b. Refer to the RUBEROID® SBS Hot-Mopped Roofing Systems Application & Specifications Manual for membrane installation requirements.
 3. One or more plies of RUBEROID® Mop Smooth.
 - a. Installed in hot asphalt over acceptable substrates.
 - b. Refer to the RUBEROID® SBS Hot-Mopped Roofing Systems Application & Specifications Manual for membrane installation requirements.
 4. One or more plies of RUBEROID® Heat-Weld Smooth.
 - a. Torch-Applied over acceptable substrates.
 - b. Refer to the RUBEROID® SBS Heat-Welded Roofing Systems Application & Specifications Manual for membrane installation requirements.
 5. One ply of Liberty™ SBS Self-Adhering Granule Cap Sheet or one ply of Liberty™ SBS Ply Sheet with Liberty™ SBS Self-Adhering Granule Cap Sheet.
 - a. Self-adhered over acceptable substrates, which include isocyanurate roof insulation and SECUROCK® roof boards.
 - b. Refer to the Liberty™ SBS Self-Adhering Roof Systems Applications and Specifications Manual for membrane installation requirements.

Note: For additional Vapor Retarder systems contact GAF Technical Services.

5.02 Steel Decks

- A. Install the vapor retarder over a minimum layer of non-isocyanurate insulation of sufficient thickness to span the deck flutes:

Note: See comment in Roof Design section of this Manual regarding insulation thickness/"R"-values required for this construction.

1. Bottom Insulation Layer.
 - a. Mechanically attach the bottom insulation layer as specified in Part 7.
2. Vapor Retarder.
 - a. Install the selected vapor retarder system. Refer to Part 5.01 E for vapor retarder systems. 3.

Top Insulation Layer(s).

- a. Install insulation over vapor retarder in hot asphalt or low-rise foam adhesive as specified in Part 7 of this Manual.

5.03 Non-Nailable Decks

- A. Vapor Retarder

1. Prime the deck with Matrix™ 307 Premium Asphalt Primer (ASTM D41) applied at the rate of 1 gal/square (0.41 L/m²) minimum.

2. For precast or prestressed concrete decks:
 - a. Hold primer application back 4" (102 mm) from panel joints, cracks, or roof openings. Allow primer adequate time to dry.
 - b. Over the panel joints, install a minimum 8" (203 mm) strip of GAFGLAS® #75 Base Sheet centered over the joint and spot attached on one side to the deck with hot asphalt.
3. For hot asphalt, select a hot asphalt-applied vapor retarder system listed in Part 5.01 E. Do not use Liberty™ SBS Self-Adhered Vapor Retarders.
4. Install insulation over vapor retarder in hot asphalt or low-rise foam adhesive as specified in Part 7 of this Manual.

5.04 Wood and Structural Wood Fiber Decks

A. Vapor Retarder

Install vapor retarder over sheathing paper (optional) on the deck, starting at the low point of the roof. Refer to Part 4 of this section for fastener types applicable to the roof deck type:

1. For hot asphalt-applied vapor retarder systems: First mechanically fasten one ply of GAFGLAS® Stratavent® Nailable Venting Base Sheet or GAFGLAS® #75 Base Sheet to the deck using fasteners approved for applicable deck type. Refer to GAFGLAS® Built-Up Roofing Systems (BUR) Applications and Specifications Manual for installation requirements.

For Liberty™ self-adhering vapor retarder systems: First mechanically fasten one ply of StormSafe™ Anchor Sheet to the deck using fasteners approved for applicable deck type. Refer to the Liberty™ SBS Self-Adhering Roof Systems Applications and Specifications Manual for installation requirements.

2. Install selected vapor retarder system. Refer to Part 5.01 for vapor retarder systems.
3. Install insulation over vapor retarder in hot asphalt or low-rise foam adhesive as specified in Part 7 of this Manual.

5.05 Lightweight Insulating Concrete or Poured Gypsum Decks

A. Vapor Retarder. (Note: Installation of insulation over new lightweight insulating concrete with or without a vapor retarder is **not** recommended.)

1. For hot asphalt-applied vapor retarder systems: First mechanically fasten one ply of GAFGLAS® Stratavent® Nailable Venting Base Sheet to the deck using fasteners approved for applicable deck type. Refer to GAFGLAS® Built-Up Roofing Systems (BUR) Applications and Specifications Manual for installation requirements. For Factory Mutual Global approved fastening patterns, refer to the current FM Global Approvals and listings.

For Liberty™ self-adhering vapor retarder systems: First mechanically fasten one ply of StormSafe™ Anchor Sheet to the deck using fasteners approved for applicable deck type. Refer to the Liberty™ SBS Self-Adhering Roof Systems Applications and Specifications Manual for installation requirements. For Factory Mutual Global approved fastening patterns, refer to the current FM Global Approvals and listings.

2. Install selected vapor retarder system. Refer to Part 5.01 for vapor retarder system.
3. Install insulation over vapor retarder in hot asphalt or low-rise foam adhesive as specified in Part 7 of this Manual.

Part 6 – Steep-Slope Requirements

6.01 General

- A. Slippage of roofing systems may occur on slopes of 1/2:12 or greater. Supplemental fastening is therefore required and, for most systems, all base, ply, and cap sheets must be installed parallel with the slope (strapping method) in accordance with the Steep-Slope Membrane Application Table. If the roof slope is less than 1/2:12, supplemental fastening and membrane strapping is not required.
- B. Use wood nailers (insulation stops) at least 3 1/2" (89 mm) wide and equal in thickness to the insulation. Nailers must be mechanically fastened to the deck and installed at right angles to the direction of the slope.

- C. On ridges where insulation stops are required, wood nailers must be a minimum 3 1/2" (89 mm) wide and equal in thickness to the insulation. Nailers shall be secured mechanically to the deck on both sides of the ridge. Where nailers meet, bevel edges to form a flush surface for membrane application.

Steep-Slope Membrane Layout

Roof System Application Method	Slopes Starting At:	Requires Strapping Method	Required Asphalt Type	Nailer Requirement/Required Spacing		Field Membrane Back-Nailing Requirement	
				For Insulated Decks and Non-Insulated, Non-Nailable Decks		For Non-Insulated, Nailable Decks	
				Slopes <2"	Slopes ≥2" but <3" ³	Slopes <2"	Slopes ≥2" but <3" ³
Mop-Applied RUBEROID [®] Membranes	1/2:12	Yes	IV	Yes/16' (4.9 m)	Yes/8' (2.4 m)	16' o.c. (4.9 m)	8' o.c. (2.4 m)
Cold-Applied RUBEROID [®] Membranes ¹	1/2:12	Yes	NA	Yes/16' ¹ (4.9 m)	Yes/8' (2.4 m)	16' o.c. (4.9 m)	8' o.c. (2.4 m)
Mop-Applied RUBEROID [®] or GAFGLAS [®] Base Ply(s) with Cold-Applied RUBEROID [®] Cap	1/2:12	Yes	IV	Yes/16' (4.9 m)	Yes/8' (2.4 m)	16' o.c. (4.9 m)	8' o.c. (2.4 m)
Liberty [™] SBS Self-Adhered Modified Bitumen	1/2:12	Yes ²	NA	Yes/16' (4.9 m)	Yes/8' (2.4 m)	16' o.c. (4.9 m)	8' o.c. (2.4 m)
Mechanically Fastened Base Ply With Mop-Applied RUBEROID [®] Cap	1/2:12	Yes	IV	Yes/16' (4.9 m)	Yes/8' (2.4 m)	16' o.c. (4.9 m)	8' o.c. (2.4 m)
Mop-Applied GAFGLAS [®] Felts with Torch- or Heat-Weld-Applied RUBEROID [®] Cap	3/4:12	Yes	IV	Yes/16' (4.9 m)	Yes/8' (2.4 m)	16' o.c. (4.9 m)	8' o.c. (2.4 m)
Mechanically Fastened Base Ply with Torch- or Heat-Weld-Applied RUBEROID [®] Cap	3/4:12	Yes	NA	Yes/16' (4.9 m)	Yes/8' (2.4 m)	16' o.c. (4.9 m)	8' o.c. (2.4 m)
Torch- or Heat-Weld-Applied RUBEROID [®] Modified Bitumen – all plies	1:12	Yes	NA	Yes/16' (4.9 m)	Yes/8' (2.4 m)	16' o.c. (4.9 m)	8' o.c. (2.4 m)
Mop-Applied GAFGLAS [®] Built-Up Roofing	1:12	Yes	III or IV	Yes/16' (4.9 m)	Yes/8' (2.4 m)	16' o.c. (4.9 m)	8' o.c. (2.4 m)

Note¹ - For cold-applied membranes, insulated steel or wood decks with slopes less than 3:12 do not require interim nailers, providing total insulation thickness is 3" (76 mm) or less and all layers are mechanically fastened. Terminate and fasten membrane finish cap sheet end laps on same spacing as indicated.

Note² - For non-insulated nailable decks, install Liberty[™] membranes perpendicular to slope and back-nail in the sidelap.

Note³ - For slopes over 3:12, contact GAF Technical Services at 1-800-766-3411.

6.02 Wood Nailers on Slopes of 1/2:12 but Less than 2:12

- A. For slopes 1/2:12 but less than 2:12, install wood nailers at the eave, at the ridge, and at intermediate points of no more than 16' (4.9 m) as outlined under the Steep-Slope Membrane Application Table. All dimensions are from inside face to inside face of the wood nailers. Ensure a snug fit with the courses of insulation, but where possible, avoid cutting the insulation.
- B. For non-insulated, nailable decks, back-nail the leading edge of the base plies directly to the deck at intervals not to exceed 16' (4.9 m). All fasteners should be covered by following courses.
- C. For non-insulated, non-nailable decks, set the wood nailers flush with decks and back-nail plies at intervals not to exceed 16' (4.9 m). All fasteners should be covered by following courses.

6.03 Wood Nailers on Slopes of 2:12 to 3:12

- A. For slopes 2:12 to 3:12, install wood nailers at the eave, at the ridge, and at intermediate spacing of no more than 8' (2.4 m) as outlined under the Steep-Slope Membrane Application Table. All dimensions are from inside face to inside face of the wood nailers.

- B. Ensure a snug fit with the courses of insulation, but avoid cutting the insulation where possible.
- C. For non-insulated, nailable decks, back-nail the plies directly to the deck at intervals not to exceed 8' (2.4 m). All fasteners should be covered by following courses.
- D. For non-insulated, non-nailable decks, set the wood nailers flush with decks and install at intervals not to exceed 8' (2.4 m). All fasteners should be covered by following courses.

6.04 Wood Nailers on Slopes Greater than 3:12

- A. For roofs with slopes greater than 3:12, contact GAF Technical Services at 1-800-766-3411.

6.05 Insulation Installation

- A. If insulation is to be installed, mechanically attach, set in GAF Low-Rise Foam Adhesive or set in hot asphalt between wood nailers in accordance with Part 7 of this section.

6.06 Membrane Installation

- A. Steep-slope applications require installation of all base and ply sheets parallel to slope (Strapping Method) as required in the Steep-Slope Membrane Layout table. Back-nail each course into wood nailers or nailable decks approximately 1" (25 mm) from the leading edge of the sheets at recommended intervals. All end laps must be at wood nailers and blind-nailed into the wood nailer on 8" (203 mm) centers. Use nails with integral metal heads at least 1" (25 mm) round or square. For non-insulated, nailable decks, back-nail the leading edge of each course as described above directly into the deck at recommended intervals.
- B. At ridges, base plies must extend across opposite sides of ridge over the nailer and be fastened on 8" (203 mm) centers. Use nails with integral metal heads at least 1" (25 mm) round or square. An additional layer of base sheet shall be centered over the ridge overlapping the fasteners at least 6" (152 mm).
- C. After completion and fastening of base plies, install GAFGLAS® cap sheets or RUBEROID® membranes parallel to slope (Strapping Method) as required in the Steep-Slope Membrane Layout table. Terminate GAFGLAS® cap sheets or RUBEROID® membranes at wood nailers and fasten the top edge of each sheet with screws and 3" (76 mm) plates on 8" (203 mm) centers across the top of the sheet. The overlapping sheet must extend at least 9" (229 mm) past the top of the underlying sheet. All end laps must be staggered to the closest wood nailer, spaced a minimum of 4' (1.2 m). On slopes of 2:12 to 3:12, the GAFGLAS® cap sheets or RUBEROID® membranes must be cut into lengths not to exceed 17' (5.2 m). For non-insulated wood decks, terminate and fasten the end of the GAFGLAS® cap sheets or RUBEROID® membranes to the deck with the same fasteners, on the same spacing indicated above.
- D. At ridges, cap sheets or RUBEROID® membranes must extend across opposite sides of the ridge over the nailer and be fastened with screws and 3" (76 mm) plates on 8" (203 mm) centers. An additional full-width ply of cap sheet or RUBEROID® membrane must be centered over the ridge to form a ridge cap, overlapping the fasteners at least 6" (152 mm).

Steep-Slope Membrane Layout—Strapping Method

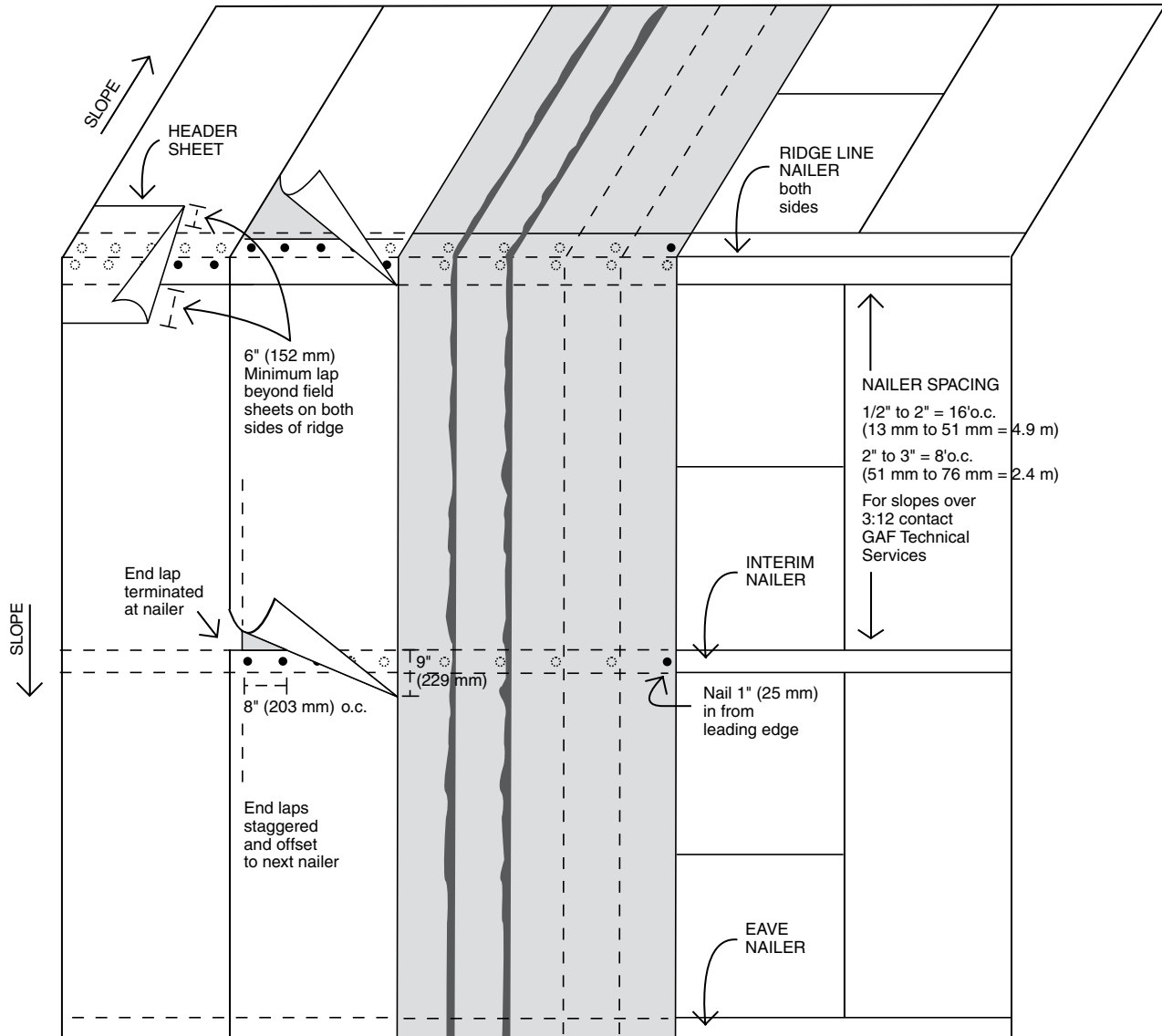

Part 7 – Insulation Installation

7.01 General

- Do not apply roof insulation and roofing until other work trades have completed jobs that require them to traverse the deck on foot or with equipment. A vapor retarder (membrane type) coated lightly with asphalt may be applied to protect the inside of the structure before the insulation and final roofing are installed. Before the application of the insulation, the vapor retarder must be carefully repaired.
- Do not install wet, damaged, or warped insulation boards.
- Install insulation boards with staggered board joints in one direction (unless taping joints).

- D. Install insulation board snug. Gap between board joints must not exceed $\frac{1}{4}$ " (6 mm). All gaps in excess of $\frac{1}{4}$ " (6 mm) must be filled with like insulation material.
- E. Do not kick insulation boards into place.
- F. Install insulation boards per insulation board manufacturer's requirements.
- G. Edges of insulation board shall be mitered and filled at ridges and elsewhere to prevent open joints or irregular surfaces. Avoid breaking or crushing of the insulation at the corners.
- H. Do not install insulation over old lightweight insulating concrete deck without the use of a vapor retarder. Do not install insulation over new lightweight insulating concrete.
- I. Steel decks require mechanical attachment of insulation using Drill-Tec™ Screws and Plates. Selected membrane systems allow or require mechanical fastening of insulation and membrane base ply with Drill-Tec™ Screws and Plates.
- J. Insulation boards must be mechanically fastened, attached with hot asphalt or an approved GAF Low-Rise Foam Adhesive as outlined below to the deck. Refer to the Roof Design section of this Manual. Insulations attached with non-GAF cold process or foam adhesives require prior written approval by GAF Technical Services.
- K. The insulation must be securely attached to the roof deck. A minimum FM 1-60 attachment is recommended. Refer to Factory Mutual Global for FM fastening patterns. Factory Mutual requires fastener density to be increased in corner and the perimeter areas. Refer to FM Loss Prevention Data Sheets, 1-28, 1-29, and 1-49.
- L. Use only fasteners with a 3" (76 mm) stress plate when mechanically attaching insulation.
- M. Do not attach insulation with nails.
- N. A maximum board size of 4' x 4' (1.22 m x 1.22 m) is to be used if the insulation is to be adhered in asphalt or low-rise foam adhesive. Approved EnergyGuard™ insulations may be installed in a full and uniform mopping of ASTM D312, Type III or IV hot asphalt applied at the rate of 25 lbs/square (1.2 kg/m²) ± 20%, over primed, poured, or precast structural concrete roof decks or approved mechanically attached GAFGLAS® base sheets, anchor sheets, and vapor retarders.
- O. Do not install any more insulation than will be completely waterproofed each day.
- P. GAF construction details are drawn to reflect typical industry uses of wood nailers at vertical penetrations such as walls or curbs, as insulation stops at ridges and perimeter edges, for attachment of metal flashings or accessories, and where required for interim back-nailing on steep-slope installations. Wood nailers may be used for insulation stops but are not required at "closed" vertical terminations such as equipment curbs, or along parapet walls where standard GAF Wall Supported Deck base flashing details are utilized.

Wood nailers are required at perimeter edges, ridges, vertical intersections, penetrations, and other flashings where any of the following conditions occur:

- Field of roof expansion joints
- Curb-to-wall or field-to-wall expansion joints
- Base flashings to non-wall supported deck details
- Open terminations such as at perimeter metal edges, gutter edges, gravel stops, interior courtyards, etc.

- Field terminations, curbs, penetrations, and other flashings that require wood-blocking for support of vertical members or rooftop equipment
- Where metal flanged flashings are installed into the roof system
- Steep-slope applications above 1/2:12 (interim nailers required)
- Where required by project designer, local code, or project insurance requirements for structural, wind, or other general design requirement

- Q. If tapered roof insulation is to be installed, all hip and valley panels must be mitered. Laced valleys are not acceptable.
- R. **Never** torch RUBEROID® APP or Heat-Weld SBS membranes directly to roof insulation other than DensDeck® Prime or SECUROCK® roof boards.
- S. Do not install cold-applied roofing systems where extruded or expanded polystyrene insulation is incorporated in the board insulation system, including polystyrene that may be used for crickets, saddles, or cants. Lightweight insulating concrete decks that use polystyrene insulation as a component are acceptable as a substrate for cold-applied roofing systems.

7.02 Additional Layers of Asphalt-Applied or Mechanically Fastened Insulation —

- A. For hot asphalt applications, install additional insulation layers, maximum 4' x 4' (1.22 m x 1.22 m) board size, in full and uniform moppings of hot asphalt applied at the rate of 25 lbs/square (1.2 kg/m²) ± 20%. Press each board firmly into place. Stagger the joints of each additional layer by as much as possible in relation to the insulation joints in the layer(s) below (minimum 6" [152 mm] stagger) to eliminate continuous vertical gaps.
- B. As an alternative method to the above, multiple layers of insulation of the same, non-tapered insulation material may be simultaneously mechanically fastened with approved fasteners and plates through the top layer of insulation to the structural deck. Individual layers of insulation must not exceed 3" (76 mm) in thickness nor total thickness of all layers should not exceed 5" (127 mm) without prior written approval of GAF Technical Services. GAF- and FM-approved insulations, a minimum of 1/2" (13 mm) thickness, may be installed over one or more layers of approved polyisocyanurate roof insulation simultaneously attached. Stagger and offset all joints of each insulation layer from underlying layers.
- C. Fastening pattern and uplift classifications for simultaneously attached insulation assemblies is dependent upon the top layer of insulation directly under the fastener plates according to the listed FM approval for the specific insulation material, deck type, and fastener assembly used. Refer to FM Loss Prevention Data Sheet 1-28 and 1-29 for additional requirements and information.

7.03 New Construction/Tear-Off Installation with GAF's Low-Rise Foam Adhesives

- A. GAF OlyBond, GAF 2-Part Roofing Adhesive, or LRF-M Adhesive distributed by GAF may be used in lieu of hot asphalt or mechanical fasteners to adhere EnergyGuard™ Polyiso, EnergyGuard™ Tapered Polyiso, EnergyGuard™ HD or HD PLUS Polyiso Cover Boards, EnergyGuard™ High Density Fiberboard, DensDeck® roof boards, SECUROCK®, and approved expanded polystyrene roof insulations in single or multiple layers to the following decks: structural or pre-cast concrete, minimum 5/8" (15.9 mm) treated plywood, approved steel decks where first layer of insulation is mechanically fastened, cementitious wood-fiber plank, pre-cast gypsum plank, and GAF-approved decks with mechanically attached or hot asphalt-applied base sheets. Maximum board size is 4' x 4' (1.22 m x 1.22 m).
- B. Insulations other than listed above require prior written approval by GAF Technical Services for use within GAF roof systems.

- C. Structural concrete roof decks must be smooth, clean, and dry. New decks must be allowed to cure a minimum of 28 days prior to application of adhesive.
- D. Ridges, depressions, and other surface defects must be ground down or corrected to provide a uniformly smooth surface. Surface cracks and holes must be repaired with a suitable non-shrink cement grout.
- E. Decks with curing compounds, surface paints, or coatings may not be acceptable. Contact GAF Technical Services for additional information.
- F. Use of GAF Low-Rise Foam Adhesive over poured gypsum and lightweight insulating concrete decks requires installation of a mechanically attached GAFGLAS® Stratavent® Nailable Base Sheet or GAFGLAS® #75 Base Sheet in accordance with GAF specifications. Installation directly over Lightweight Aggregate Structural Concrete decks requires prior written approval by GAF Technical Services.
- G. Installation directly to steel decks requires prior written approval from GAF Technical Services. Note: Adhesive applications directly to steel roof decks do not conform with current Factory Mutual requirements for insulated steel deck roof assemblies.
- H. Substrate surfaces must be smooth, clean, and dry. Remove all dust, dirt, oil, grease, moisture, and debris from the decking surface. Metal surfaces must be cleaned with coatings removed. Uneven surfaces, deck irregularities, and offsets greater than $\frac{3}{16}$ " (4.8 mm) must be corrected prior to application to provide a uniform surface. GAF will not be responsible for lack of adhesion due to uneven decking or irregular existing roof surfaces that prevent adequate contact between the adhesive and the insulation materials.
- I. Surfaces with visible moisture or frost are not acceptable. Store all GAF Low-Rise Foam Adhesives and containers between 45°F (7.2°C) and 95°F (35°C) in a cool, dry place. When using a Pace Cart dispenser, the minimum product temperature before installation into the PaceCart dispenser is 72°F (22°C). Prior to placement in PaceCart hoppers, shake the Part 2 (resin) component for at least one minute.
- J. Do not apply GAF Low-Rise Foam Adhesives when temperatures are below, or expected to fall below, 40°F (4.4°C), or above 120°F (49°C). Follow all cold-weather application precautions found in Part 11 of this Manual and on package labels.
- K. Insulation boards shall be laid in a staggered pattern. Additional layers of insulation shall be laid with all joints staggered and offset from preceding layers. Maximum allowable insulation board size is 4' x 4' (1.22 m x 1.22 m).
- L. Beginning at the low point of the roof, apply GAF Low-Rise Foam Adhesives with continuous, evenly spaced ribbons at a maximum speed of 12" (305 mm) on center for the field of the roof and 6" (152 mm) on center for perimeters and corners.
- M. Apply GAF Low-Rise Foam Adhesives in a minimum 1" (25 mm) wide, wet, continuous bead at the approximate rate of .75 to 1.25 gal/sq² (.30 to .51 L/m²). When using GAF 2-Part Roofing Adhesive, a 2.5" (62 mm) wide, wet, continuous bead is required. The GAF 2-Part Roofing Adhesive can be applied in a "spatter pattern" with a spatter nozzle. A 3.75 lb./sq. (18.3 kg/m²) thickness is required for full coverage on substrates. Application rates will vary and must be increased for rougher surfaces.
- N. Allow adhesive rows to spread and rise approximately $\frac{3}{4}$ " (19 mm) to 1" (25 mm) in height prior to installation of insulation boards. The spatter pattern should yield a heavily textured, even coating of approximately $\frac{1}{4}$ " (6.2 mm) to $\frac{1}{2}$ " (12 mm) nominal thickness height on the peaks of the spattered adhesive. Set boards into the wet adhesive and walk in place until the adhesive sets, which takes approximately 4 to 8 minutes, depending on ambient air temperature. Boards that will not lay flat due to cupping, warping, crowning, or surface irregularities of the substrate should have weights placed on the boards until the low-rise foam adhesive has achieved proper adhesion to hold the board in place.

- O. In areas where voids exist between the adhesive and the bottom of the insulation, or where adhesive rows have become tack-free or set-up due to excessive exposure time, install additional rows of adhesive.
- P. Cold-weather applications affect adhesive reaction and set times. Insulation materials must be set into the wet adhesive prior to its reaching a tack-free state. Follow all product installation instructions.
- Q. Due to the large variety of potential roof assemblies, contact GAF Technical Services for specific information and requirements on current UL, FM, or other code and insurance approvals for installations incorporating GAF's Low-Rise Foam Adhesive.

7.04 Re-cover Installations with GAF's Low-Rise Foam Adhesives

- A. Insulation attachment to asphalt-based, prepared, existing, smooth, and granule-surfaced built-up roof membranes with GAF's Low-Rise Foam Adhesives requires careful review of the existing roof assembly and thorough preparation of all surfaces. It is the responsibility of the roofing contractor, deck contractor, or owner's representative to determine the condition and suitability of the existing roof system and its surface for re-cover applications. GAF assumes no responsibility for the condition of the existing roof membrane, substrate, or adhesion of existing surfacing, including granules on weathered granulated membranes.
- B. Existing smooth and granule-surfaced membranes require cleaning of the entire roof surface to remove all dust, dirt, debris, loose granules, and surface contaminants. Cut out all blisters, ridges, wrinkles, and other surface defects, and secure any loose existing membrane material as necessary.
- C. Remove and replace wet insulation and other roofing materials.
- D. Large voids and surface irregularities deeper than $\frac{1}{8}$ " (3.2 mm) must be repaired prior to installation.
- E. GAF's Low-Rise Foam Adhesives are not suitable for use over coal tar pitch built-up roofs, fresh asphalt roof cements or mastics, existing gravel-surfaced built-up roofs, and built-up roofs coated with ASTM D312, Type I asphalt. Re-cover applications over existing sprayed-in-place polyurethane foam roofs are not acceptable for GAF guarantee installations.
- F. Existing granule-surfaced and smooth-surfaced roofs coated with aluminum, acrylic, elastomeric, emulsion, and other similar coatings must be tested for adhesion prior to installation of GAF's Low-Rise Foam Adhesives.

7.05 Roof Tape

- A. Roof tape, if required over insulation joints, shall be laid evenly, smoothly, and embedded in a uniform coating of hot steep asphalt with 4" (102 mm) end laps. Be careful to ensure smooth application of tape, and full embedment of the tape in the asphalt.
- B. Application of the asphalt and tape may be made by either "back-mopping" the tape and pressing the tape into place, or by use of taping machine (small felt layer), which will apply asphalt to the tape in a continuous operation.

Part 8 – Membrane System Installation

8.01 General

- A. Substrates must be inspected and accepted by the contractor as suitable to receive and hold roof membrane materials.
- B. Start the installation of all membrane plies at the low point or drains, so the flow of water is over or parallel to the ply laps, but never against the laps.
- C. Position and align roll prior to application. Chalk lines where necessary to assure proper alignment and headlap widths of membrane plies.
- D. Use half base-sheet width as a starter strip in two-ply roof constructions.
- E. Installation of all membrane plies, except those that are mechanically fastened, shall result in a visible, uniform flow-out of bitumen at side and end laps.
- F. Assure that all membrane plies lay flat and are uniformly secured to their substrate. Wrinkles, fishmouths, and similar defects must be removed and patched.
- G. Extend all membrane plies to dimensions necessary to accommodate flashing conditions shown in the RUBEROID®/GAFGLAS® Roof Flashing Details Manual.
- H. All lap edges for GAF cap membranes shall be rolled-in or walked-in immediately after installation. Additional care must be taken to ensure complete bonding at “T” laps. Lap edges on all membrane sheets should be inspected for full and uniform bonding to the underlying membrane sheet.
- I. Stagger all adjacent end laps for all membrane plies a minimum of 18" (457 mm). Side laps shall not coincide with underlying plies in multiple-layer applications.
- J. Prime all masonry, metal, and existing asphalt surfaces and substrate with asphalt primer where insulation or GAF membranes are to be adhered. Matrix™ 307 Premium Asphalt Primer (ASTM D41) shall be applied at the rate of 1 gal/square (0.41 L/m²). Allow the primer adequate time to dry.
- K. Brooming-in of glass felts is vital to minimize voids and ensure complete, uniform attachment.
- L. Occasionally, a roll of felt or membrane will contain a splice that was fabricated as part of the manufacturing process. These splices are marked. Cut out all splices and treat as an end lap.
- M. Back-nailing of felts and cap sheets, and the use of ASTM D312 Type IV asphalt, is required on slopes 1/2:12 or greater. Refer to General Installation Requirements Part 6, “Steep-Slope Requirements.”
- N. RUBEROID® Heat-Welded membranes are intended for use with RUBEROID® Heat-Welded flashing membranes and should not be mixed with APP materials. RUBEROID® Heat-Welded membranes may be used with compatible asphalt-based built-up roofing systems as torch-applied flashing materials.
- O. Lap edges for Liberty™ Self-Adhering Base/Ply and Cap Sheet shall be rolled in or firmly hand-pressed in immediately after installation. During application, all sheets should be rolled in from the center out to the edges to eliminate voids and trapped air pockets. Lap edges of all membrane sheets should be inspected for full and uniform bonding to the underlying membrane sheet.
- P. Apply Liberty™ SBS Self-Adhering membranes only when the weather is dry and temperatures are 45°F (7°C) and rising. Substrates, insulations, and roll goods must be free of moisture, dust, dirt, or other contaminants.

8.02 Phasing

- A. The term “phasing” refers to the practice of applying part of a total roof membrane at one time and allowing that part to remain exposed to the weather for a period of time before applying the remaining elements of the roof system. Membranes applied in this manner are subject to early deterioration. Blisters, voids, membrane damage, and moisture infiltration are much more likely to occur in “phased” roof membranes.
- B. GAF does not approve the practice of “phasing.”
- C. Whenever it is necessary to put a building “in the dry” quickly, a temporary roof covering is recommended; this temporary roof should be removed prior to installation of the roof system.

8.03 Base Sheets – Mechanically Fastened

- A. After allowing the base sheet to relax, keep sheet taut, fastening at center of sheet and working in opposite directions. Push all wrinkles and buckles ahead as fastening proceeds.

The following are minimum fastening patterns that may be used when fastening the base ply. For Factory Mutual Global-approved fastening patterns, refer to the current FM Global Approvals and listings.

1. Base sheet (no insulation) on decks of wood, plywood, OSB, lightweight concrete, gypsum, or cementitious wood fiber (Figure 1, next page).
 - A. Lap the base sheet 2" (51 mm), and mechanically fasten with three rows of fasteners. The first row (on the seam) will be 1" (25 mm) from the leading edge and on 9" (229 mm) centers. Locate the second row of fasteners 14" (356 mm) from the leading edge and on 18" (457 mm) centers. The third row of fasteners shall be 26" (660 mm) from the leading edge on 18" (457 mm) centers. The centers for the second and third rows should be staggered.
 - B. Plywood or OSB decks only. Lap the base sheet 2" (51 mm), and mechanically fasten with four equally spaced rows of Senco Tape and N12 BAB or N12 FAB Staples spaced at 9" (229 mm) o.c. centered over the 2" (51 mm) wide laps and at 9" (229 mm) o.c. in three rows equally spaced in the field of the sheet.
2. Simultaneous fastening base sheets with insulation, with the fasteners having a 3" (76 mm) plate (Figure 2, next page):
 - A. Lap the base sheet 3" (76 mm). Screws and plates are then installed in 3 staggered, equally spaced rows on 24" (610 mm) maximum centers in each row. One row is in the 2" (51 mm) side lap, the other rows are located equidistant from the lap rows approximately 12" - 13" (305 - 330 mm) from the lap rows. This pattern results in approximately one fastener per 2.1 square feet (0.20 m). Along building perimeters (minimum 4 foot wide) (1.22 m) fastening pattern must be increased to one fastener per 1.2 square feet (0.11 m), in 4 staggered, equally spaced rows of fasteners on 18" (457 mm) centers.

Note: When fastening base sheets using screws and plates without insulation or over DensDeck®, the plate must be of a design that allows it to lie flat on the deck.

Figure 1

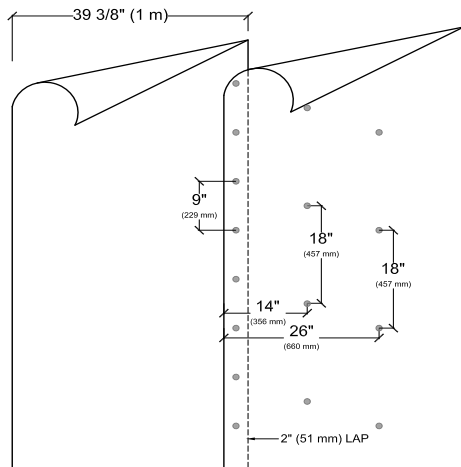
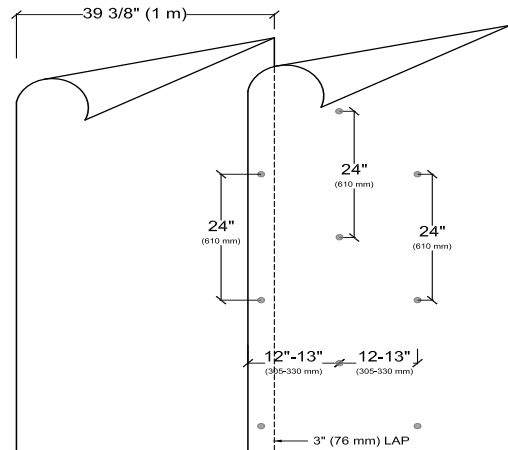

Figure 2



8.04 Base/Interply Sheets – Hot Asphalt Application

A. General

The following applies to all GAF sheets, which may be used as ply sheets or base sheets (excluding GAFGLAS® Stratavent® Perforated Venting Base Sheet):

1. Foot- and machine-traffic on freshly applied membranes with asphalt must be kept to a minimum to reduce the possibility of asphalt displacement due to “point-applied” pressure. The potential result is the creation of an area where the asphalt quantity may be too light to perform the required waterproofing or bonding function.
 2. Workmen must stand on the insulation, or deck side of the system, and avoid traffic on the freshly laid membrane system for a long enough time to allow the asphalt to set up. Do not allow equipment over, or store materials on, the freshly laid membrane. Asphalt dispensing equipment must have balloon tires.
- B. For slopes under $\frac{1}{2}$:12, Type III or IV asphalt can be used. Type IV must be used on all slopes $\frac{1}{2}$:12 and greater.
 - C. Asphalt shall be applied in a uniform layer, without voids, at a rate of 25 lb/square (1.2 kg/m²) \pm 20%. See General Installation Requirements Part 3, “Asphalt.”
 - D. Apply asphalt so that a small bead of asphalt shows at the edge of the membrane. Do not allow heavy flows of asphalt to extend beyond the membrane edge. Heavy, irregular surface flows of asphalt will make proper application of cap membrane difficult.
 - E. In the event a wrinkle or a fishmouth forms during the application of the membrane, do not “walk it down” as the memory of the sheet or felt may cause it to reappear. Fishmouths or wrinkles shall be sliced open and patched with hot asphalt and additional membranes. Avoid cutting into the plies below the fishmouth or wrinkle by angling the knife blade to the side.
 - F. Base plies must be installed with all side and end laps staggered and offset from previous plies with adjacent end laps a minimum of 18" (457 mm) apart.

Base Sheet & Ply Felt Application Chart

	Recommended Starter Rolls	2 nd Full-Width Sheet Side Lap/Exposure	Following Courses Lap/Exposure	End Laps ²
RUBEROID® Base Sheets* ¹	39 3/8" (1 m)	Lap 3" (76 mm) Exp 36 3/8" (924 mm)	Same	6" (152 mm)
GAFGLAS® Base Sheets*	39 3/8" (1 m)	Lap 2" (51 mm) Exp 37 3/8" (930 mm)	Same	4" (102 mm)
One-Ply GAFGLAS® Felt*	39 3/8" (1 m)	Lap 2" (51 mm) Exp 37 3/8" (949 mm)	Same	6" (152 mm)
Two-Ply GAFGLAS® Felt	19 11/16" (500 mm) 39 3/8" (1 m)	Lap 21 11/16" (551 mm) Exp 17 11/16" (449 mm)	Lap 20 11/16" (525 mm) Exp 18 11/16" (475 mm)	6" (152 mm)
Three-Ply GAFGLAS® Felt	13 1/8" (333 mm), 26 1/4" (667 mm), 39 3/8" (1 m)	Lap 28 1/4" (718 mm) Exp 11 1/8" (283 mm)	Lap 26 15/16" (684 mm) Exp 12 7/16" (316 mm)	6" (152 mm)
Four-Ply GAFGLAS® Felt	9 7/8" (251 mm), 19 11/16" (500 mm), 29 1/2" (749 mm), 39 3/8" (1 m)	Lap 31 1/2" (800 mm) Exp 7 7/8" (200 mm)	Lap 30 1/16" (764 mm) Exp 9 5/16" (236 mm)	6" (152 mm)

*Where necessary to maintain offset between all plies, base sheet and one-ply starter rolls may be cut to narrower widths to maintain a suitable offset from succeeding courses. Refer to individual specification installation drawings.

¹RUBEROID® Mop Smooth 1.5 and RUBEROID® 20 Smooth only. RUBEROID® Modified Base Sheet requires 2" (51 mm) sidelaps and 4" (102 mm) end laps.

²All end laps must be staggered a minimum of 18" (457 mm) from adjacent or underlying courses.

8.05 Liberty™ SBS Self-Adhering Base/Ply Sheet and WeatherWatch® XT Leak Barrier Application

- Liberty™ SBS Self-Adhering Base/Ply membrane or WeatherWatch® XT Leak Barrier may be installed as a base ply directly over GAF EnergyGuard™ Polyiso Insulation, or SECUROCK® roof boards. StormSafe™ Anchor Sheet may be used under base/ply sheets to ensure a good bond.
- Coiled rolls should be unrolled and allowed to "relax" prior to installation. Cut sheets into manageable lengths that will allow for a wrinkle and void-free installation.
- Prior to installation, clean the surface of the installed insulation, removing all debris, dirt, moisture, and other contaminants.
- Starting at the low point of the roof, install one ply of Liberty™ SBS Self-Adhering Base/Ply Sheet or WeatherWatch® Leak Barrier lapping 3" (76 mm) on sides and 6" (152 mm) on ends. Fold the bottom half of the sheet back and remove the release film from this part of the roll. Working from the center of the sheet, carefully roll and hand-press the sheet back into place over the base ply, being careful to avoid wrinkles and trapped air while maintaining proper alignment. Fold the upper portion of the sheet back on itself to expose and remove the remaining release film and finish the roll. Install the upper portion of the roll working from the center of the sheet outward toward the ends. Firmly hand-press the sheet to avoid wrinkles and trapped air and finish with a weighted roller over the entire sheet to ensure full contact with the insulation. All side and end laps must be staggered and offset from underlying courses a minimum of 6" (152 mm).

- E. Interply End Lap Detail: End laps must be a minimum of 6" (152 mm), staggered and offset from adjacent courses a minimum of 3' (914 mm). Remove the release film from the underside of the overlapping sheet and form the lap without wrinkles or voids. Firmly press and roll this overlap seam with a weighted roller to complete.

8.06 GAFGLAS® Stratavent® Perforated Venting Base Sheet

Note: DO NOT torch-apply RUBEROID® Heat-Welded membranes directly to GAFGLAS® Stratavent® Perforated Venting Base Sheet. At least one ply of GAFGLAS® #75 Base Sheet MUST be hot-mopped over the GAFGLAS® Stratavent® Perforated Venting Base Sheet before torch-applying RUBEROID® Heat-Welded membranes.

- A. Roll GAFGLAS® Stratavent® Perforated Venting Base Sheet out dry, granule-surfaced down directly over EnergyGuard™ Polyiso Insulation, asphalt-primed structural concrete roof decks, and SECUROCK® and selected DensDeck® roof boards.
- B. For re-cover applications, GAFGLAS® Stratavent® Perforated Venting Base Sheet may be installed over prepared existing smooth, built-up, or mineral-surfaced asphalt-based roofing systems surfaced with conventional, fiberglass-reinforced cap sheets or granule-surfaced SBS modified bitumen membranes.
- C. Follow all re-cover recommendations and requirements contained in General Installation Requirements parts 2.03 and 2.04, Roof Design, and the RUBEROID®/GAFGLAS® Roof Flashing Details Manual.
- D. Existing surfaces must be smooth, clean, and dry. Existing granule surfaces must be determined to be in sound condition. Power-brooming and power-washing of the existing granule surfaces is required to remove all loose granules or dirt. After drying thoroughly, prime the existing surface with Matrix™ 307 Premium Asphalt Primer and allow to dry prior to installation of roofing materials.
- E. Lap base sheet 2" (51 mm) on the sides and 4" (102 mm) on the ends, with adjacent end laps a minimum of 18" (457 mm) apart.
- F. Install the subsequent system ply/plies in hot asphalt over the GAFGLAS® Stratavent® Perforated Venting Base Sheet. The hot asphalt used to install the subsequent ply/plies mopped over the surface of GAFGLAS® Stratavent® Perforated Venting Base Sheet flows through the perforations to attach the base sheet and membrane system to the substrate.

8.07 RUBEROID® SBS Heat-Welded Membrane Application

- A. Do not install RUBEROID® Heat-Welded membranes without careful review and implementation of all relevant safety and fire-watch requirements, including materials/combustible substrates review, LP-Gas equipment storage and handling guidelines, worker safety precautions, and training. Refer to General Installation Requirements Part 1.06, "Safety Considerations and Warnings," for additional recommendations and safety precautions.
- B. The surface over which the membrane is to be installed must be clean, smooth, dry, and prepared in accordance with this Manual. Do not apply RUBEROID® Heat-Welded membranes directly to a fresh asphalt glaze or flood coat, or over base plies with excessive asphalt mopping bleed-out at laps.
- C. Do not install RUBEROID® Heat-Welded membranes over base plies or materials installed with solvent-based cold adhesives or mastics.
- D. For slopes $\frac{3}{4}$:12 and over, RUBEROID® Heat-Welded membranes must be run vertically, parallel to roof slope and back-nailed in accordance with General Installation Requirements Part 6, "Installation on Steep-Slope $\frac{3}{4}$:12 and Over." For slopes less than $\frac{3}{4}$:12, install cap sheet perpendicular to slope.

- E. Cap sheet application: Install full-width cap sheets, lapping 3" (76 mm) on the sides and 6" (152 mm) on ends. Stagger adjacent end laps a minimum of 18" (457 mm) apart. All side and end laps must be staggered from underlying plies.
- F. Never apply RUBEROID® Heat-Welded membranes by any method except welding with a propane torch or other equipment specifically designed for application of SBS modified bitumen.
- G. The coiled membrane must be unrolled approximately 10' (3 m), aligned, then the propane torch flame applied uniformly across the exposed back surface of the membrane and lap areas until the compound reaches the proper application temperature and exhibits a slight sheen. Be sure that there is complete burn-off of release films where present on the underside of the rolls, membrane selvage edges, or both surfaces as applicable. Avoid overheating, which may result in damage to or improper adhesion of the membrane. (The flame should be moved from side to side in the shape of an "L," applying about 75% of the heat to the membrane and 25% to the substrate or underlying plies including the lap area of the previously installed courses.) The membrane is slowly unrolled as heat is applied to ensure proper adhesion. When complete, re-roll the opposite end of the membrane and install in the same manner.
- H. A minimum $\frac{1}{16}$ " (2 mm) asphalt flow-out must be obtained at all seam areas. Dry laps are not acceptable. To ensure the proper bead of bitumen at the seam areas, a GAF roller may be used. Roller application should follow behind the torch no more than 4' (1.22 m) nor less than 3' (914 mm) to be sure that the membrane will be at the proper temperature to produce proper flow. Hand rollers or "walking-in the seam" methods are also acceptable. Check all seams for full and uniform adhesion. Unadhered seams must be lifted with a heated trowel and resealed by lightly torching the seam area.
- I. Matching granules may be broadcast into the modified bitumen bleed-out at seams while hot to enhance the finished appearance of the membrane. It is not required for issuance of a GAF Guarantee.
- J. All end laps must be staggered a minimum of 18" (457 mm) so that no adjacent end laps coincide. If end laps fall in line or are not staggered the proper distance, a full width of RUBEROID® Heat-Welded membrane must be installed over the end laps. End laps, flashing sheets, and other seams formed over granule surfaces require pre-heating of the top surface of the underlying granule surface membrane to a point where the granules just begin to sink into, and the modified bitumen compound comes up through, the granules to ensure proper seam construction and adhesion.
- K. All laps must be parallel or perpendicular to the slope of the roof such that the flow of water is never against the lap.
- L. SBS membranes must not be applied during adverse weather or without precautionary measures in temperatures below 45°F (7.2°C). Refer to Part 11 in this section for additional information on cold-weather application precautions.

Part 9 – Flashing

9.01 General

- A. Refer to the RUBEROID®/GAFGLAS® Roof Flashing Details Manual. Install flashing materials as shown in the Flashing Details Manual.
- B. Base flashing constructions (except Lexsuco®) for 15- and 20-year RUBEROID® roof systems require a minimum two-ply construction. Prior to installing the RUBEROID® flashing membrane, a backer ply must be installed extending the full height of the base flashing.
- C. Basic wood-blocking anchorage recommendations are found in Factory Mutual Data Sheet 1-49. These recommendations are required for Factory Mutual-approved projects.

- D. All penetrations should be at least 18" (457 mm) from curbs, walls, and edges to provide for proper flashing.
- E. Install flashing sheets starting at low points.
- F. Where indicated by GAF construction details, install base sheets and backer plies in Type III or IV hot asphalt. Maintain asphalt at $EVT \pm 25^{\circ}F (\pm 13.9^{\circ}C)$ for all base and ply sheets used in flashing details. Never use solvent-based flashing cements, adhesives, mastics, and coatings in conjunction with RUBEROID® Heat-Welded membranes.
- G. Prime all metal flashings and masonry surfaces with Matrix™ 307 Premium Asphalt Primer and allow to dry prior to installation of flashing materials.
- H. Only use approved GAF membranes in construction of flashing details.
- I. Do not use metal base flashing. Damage to the roofing system caused by metal base flashing is not the responsibility of GAF.
- J. Base flashing should extend a minimum of 8" (203 mm) and a maximum of 24" (610 mm) above the roof line.
- K. Corner membrane flashings, such as "bow ties" for outside corners and "footballs" for inside corners or other membrane reinforcements, are required to ensure that base flashing corners are sealed at cant areas. Alternate method of the corner reinforcing: install a smooth Heat-Welded membrane reinforcement piece on the prepared corner substrate prior to final surfacing membrane. Refer to the RUBEROID®/GAFGLAS® Roof Flashing Details Manual.
- L. Alternate flashing material: Lexsuco® RF, ME, and BW Flashings can also be used in conjunction with GAFGLAS® and RUBEROID® gravel- and mineral-surfaced built-up and modified bitumen roofing systems and will qualify for guarantee terms up to 20 years depending on zone. Refer to Lexsuco® flashing details in the RUBEROID®/GAFGLAS® Roof Flashing Details Manual and with published product literature for installation requirements and instructions.

Note: Mastic and fabric coursing is **not** an acceptable alternative for proper flashing and counterflashing details.

9.02 Cant Strips and Wood Nailers

- A. Cant strips
 1. EnergyGuard™ Perlite Cant Strips must be installed at the intersection of the roof and all walls, parapets, curbs, or transitions approaching 90° that are to be flashed. They shall be approximately 4" (102 mm) in horizontal and 4" (102 mm) in vertical dimension. The face of the cant shall have an incline of not more than 45° with the roof.
 2. Wood cants shall be solid. Perlite-based cant strips must comply with ASTM C728. Do not use fiberboard cants for torch-grade installations. Use solid wood cants when mechanical securement to cants is required or when solid-wood cants will help stabilize the vertical wood nailers at projections or expansion-joint openings.
 3. Masonry cants shall be integrally cast to the wall and deck. They shall be finished and prepared with the same care as the deck. The cant shall be constructed so that it provides a vertical offset equal in thickness to the roof insulation.
 4. Metal cant or metal curb strips are not approved.
 5. Cants shall always be installed on top of the roof insulation or wood nailers.

6. Mechanically fasten cant where applicable. Otherwise, set in hot asphalt and install as shown in the RUBEROID®/GAFGLAS® Roof Flashing Details Manual. Do not use solvent-based cements or adhesives with RUBEROID® Heat-Welded membranes.
 7. Neatly fit all joints and miters.
- B. Wood nailers
1. Wood nailers must be 3 1/2" (89 mm) minimum width or 1" (25 mm) wider than metal flange and minimum 1" (25 mm) thick and securely fastened to the deck.
 2. Wood nailers shall be the same thickness as tapered-edge strip or insulation.
 3. For roof systems requiring perimeter venting, nailers shall be slotted.

9.03 Sheet Metal

- A. Metal should not be used as a component of base flashing. Because of the high coefficient of expansion of sheet metals and the large temperature changes that can be experienced on a roof, sheet-metal or exposed-metal components must be isolated from the waterproofing components of the roofing and flashing system as efficiently as possible to prevent the metal from splitting the membranes.
- GAF assumes no responsibility for damage to the roofing system caused by the movement of accessory metal.
- B. When it is unavoidable to use metal in the roofing system (i.e., lead flange at drains, gravel stops), wood nailers and insulation stops 1" (25 mm) wider than the metal flange should be provided for metal flange securement.
- C. For RUBEROID® Heat-Welded membranes, set metal flange in softened membranes (torch-heated), and secure with fasteners of the same type metal as the flange. The metal flange is then sealed using the applicable flashing detail to meet guarantee requirements.
- D. Metal accessories (gravel stops, counterflashing, etc.) should be 16-oz. (0.56 mm) copper, 24-gauge (0.71 mm) galvanized or stainless steel, 2 1/2" - 4-lb (1.1 - 1.8 kg) lead, or 0.032" (0.81 mm) aluminum.
- E. Fabricate and install all sheet-metal materials as shown in applicable construction details. Refer to SMACNA (Sheet Metal and Air Conditioning Contractors National Association, Inc.) for guidance on sheet metal treatments not addressed in the RUBEROID®/GAFGLAS® Roof Flashing Details Manual.
- F. Clean metal and apply asphalt primer to all sheet-metal surfaces that will come into contact with asphalt or other bituminous materials; allow the primer adequate time to dry. Coat metals that come into contact with each other with bituminous paint or other bituminous-separating material.
- G. Use fastener types compatible with the sheet-metal type.
1. Copper or lead-coated copper: use copper or bronze fasteners.
 2. Lead and galvanized steel: use galvanized or cadmium-plated sheet fasteners.
 3. Aluminum: use aluminum fasteners.
 4. Stainless steel: use stainless steel fasteners.
- H. Metal counterflashing shall have a minimum 4" (102 mm) face with a drip lip. The bottom edge of the counterflashing shall cover the roofing membrane and/or base flashing by a minimum of 4" (102 mm). Metal counterflashing used for masonry walls, wooden walls, or through wall metal flashings should be a two-piece

design to allow for installation and later removal. Metal counterflashings for stucco, EIFS, wood siding, or similar materials should be designed to receive and set as a base for those materials, such as "Z"-type flashing, while providing for securement of separate metal counterflashing to cover base flashings. Metal end joints shall be lapped 3" (76 mm) or more. Adequate fasteners must be provided to secure against wind forces. Skirt fasteners shall be watertight.

- I. Metal termination bars shall be a minimum of $\frac{1}{10}$ " (3 mm) thick x 1" (25 mm) wide with preformed sealant edge lap. Bar should have $\frac{1}{4}$ " (6 mm) x $\frac{3}{8}$ " (10 mm) slotted holes on 4" (102 mm) centers to facilitate mechanical anchorage.

Note: Termination bars are not suitable in all base flashing and wall flashing conditions. Termination bars may only be used in conjunction with an appropriate counterflashing extending a minimum of 4" (102 mm) below the termination bar.

- J. Metal flanges for gravel stops, eave strips, and pitch pockets to be used in conjunction with roofing shall be primed (both sides). For RUBEROID® Heat-Welded roof systems, set metal flanges in softened membranes (torch-heated) and nail 4" (102 mm) o.c. to wood nailers or insulation stops.
- K. All flanges shall be a minimum of 3" (76 mm). The gravel stop lip should be at least $\frac{3}{4}$ " (19 mm) high. Eave strip lips shall be at least $\frac{3}{8}$ " (10 mm) high. Provision must be made for securing the skirt to the face of the wall. This may be wood-nailer strips for masonry and metal construction. In all cases, gravel stop and eave-strip nailer should be fastened to the deck or deck system with adequate resistance against wind forces.
- L. Provision must be made for securing the skirt to the face of the wall. This may be wood-nailer strips for masonry and metal construction. In all cases, gravel stop and eave-strip nailer should be fastened to the deck or deck system with adequate resistance against wind forces.
- M. Stacks shall have metal-sleeve flashing a minimum of 8" (203 mm) high. Pitch pockets for brackets, supports, pad-eyes, etc., shall have a 4" (102 mm) minimum height metal sleeve.
- N. On reroofing projects, provisions shall be made for reinstallation of existing sheet-metal duct work, equipment, coping metal, and counterflashing removed in conjunction with the new work. Also, provide for cleaning and repairing of existing defective sheet metal, and replacement of missing and irreparable sheet metal to match existing types. Light-gauge sheet-metal flashings that are incorporated into the RUBEROID® Heat-Welded roof system are not suitable for re-use and must be replaced with new material.
- O. Conduits and piping such as electrical and gas lines must be set on wood blocking or some other form of support. Wood blocking/supports must be set on doubler pads (an additional layer of the roof membrane).

9.04 RUBEROID® Heat-Welded Flashing Membrane Application

- A. RUBEROID® Heat-Welded membranes used for flashing material can only be installed using a propane torch or other equipment intended for heat-weldable SBS materials.
- B. Refer to the RUBEROID®/GAFGLAS® Roof Flashing Details Manual.
- C. Wood curbs and walls must be covered with a layer of GAFGLAS® #75 Base Sheet or backer ply of selected two-ply flashing system and fastened 8" (203 mm) o.c. in all directions with approved fasteners with minimum 1" (25 mm) diameter or square caps. All vertical laps shall be 4" (102 mm). Base sheet or backer ply must extend out onto field of roof a minimum of 4" (102 mm) or as shown in the applicable GAF flashing detail.
- D. Backer plies installed over masonry or other non-nailable substrates in hot asphalt must be cut into manageable lengths to ensure adequate adhesion to cant strip and vertical surfaces without excessive voids. All vertical laps shall be 3" (76 mm). Backer ply shall extend out onto field of roof as shown in the applicable GAF flashing detail.

- E. All membrane plies must be extended to 2" (51 mm) above top of cant strip and cut-off prior to installation of flashing plies.
- F. It is recommended that the finished ply of base flashing be run vertically to provide a selvage edge that will aid in achieving proper adhesion at the vertical laps. The finished flashing ply shall extend out onto the field of the roof as shown in the applicable GAF flashing detail, and must be extended a minimum of 4" (102 mm) beyond the edge of the prior flashing plies. The flashing must be soundly adhered to the parapet, cant area, and roof surface to result in a minimum-void, non-bridging construction.
- G. Vertical laps for RUBEROID® SBS Heat-Welded membranes shall be 3" (76 mm). If the sheet is run horizontally or where laps must be constructed onto granule surfaces, the vertical laps must be a minimum of 6" (152 mm). Horizontal applications also require trimming of all exposed membrane selvage edges or installation in a manner that ensures all selvage edge is fully covered by a suitable metal or approved counterflashing.
- H. Torch-Method Application:
 1. Measure and cut RUBEROID® Heat-Welded membrane into the required lengths.
 2. Apply the propane torch flame uniformly across the back surface of the membrane and lap areas until the compound reaches the proper application temperature and exhibits a slight sheen. Be careful during application to ensure the complete burn-off of release films where present on the underside of the rolls, membrane selvage edges, or both surfaces as applicable. Avoid overheating which may result in damage to or improper adhesion of the membrane. (The flame should be moved from side to side in the shape of an "L," applying about 75% of the heat to the membrane and 25% to the substrate or underlying plies including the lap area of the previously installed courses.) The membrane is slowly unrolled as heat is applied to ensure proper adhesion. Immediately nail the top of the flashing as specified in flashing detail to prevent slippage.
 3. Membrane flashing sheets may be either back-torched and set into position, or rolled and torched into position as the flashing sheet is uncoiled. Flashing sheets must be carefully pressed into place to ensure full adhesion to the substrate and backer plies. Laps must be rolled or pressed to ensure proper seaming with a minimum $\frac{1}{16}$ " (2 mm) bead of bitumen at all seams.
- I. All base flashings to rooftop curbs, parapet walls, and other vertical surfaces require positive mechanical attachment along the top edge of the completed flashing. As indicated in the applicable flashing detail, vertical flashings shall be secured with mechanical fasteners approved by GAF 8" (203 mm) o.c. up to 12" (305 mm) above the finished roof, and 4" (102 mm) o.c. for flashing heights up to 24" (610 mm).
- J. Install metal or other suitable counterflashing to extend a minimum of 4" (102 mm) below the top edge of the installed and fastened base flashings.

9.05 RUBEROID® UltraClad® Torch-Applied SBS Foil-Faced Flashing Membrane

- A. RUBEROID® UltraClad® SBS Flashing Membrane can only be installed using a propane torch or other equipment intended for heat-weldable modified bitumen membranes.
- B. **SAFETY PRECAUTION:** Do not install RUBEROID® UltraClad® membrane without careful review and implementation of all relevant safety and fire-watch requirements, including materials/combustible substrate review, LP-Gas equipment storage and handling guidelines, worker-safety precautions, and training. Refer to General Installation Requirements Part 1.06, "Safety Considerations and Warnings," for additional recommendations and safety precautions.

exposure to open flame. Wood curbs and walls, and insulated curbs or vertical substrates, must be covered with a layer of approved GAF base sheet or backer ply of selected two-ply flashing system. For nailable substrates, fasten 8" (203 mm) o.c. in all directions with approved fasteners with minimum 1" (25 mm) diameter or square caps. For insulated or masonry substrates, set backer ply in a solid mopping of hot-steep asphalt. All vertical laps shall be 4" (102 mm). Base sheet or backer ply must extend out onto field of roof a minimum of 4" (102 mm) or as shown in applicable GAF flashing detail.

- D. RUBEROID® UltraClad® SBS membrane shall be installed vertically lapping 3" (76 mm.) on sides along the product selvage edge. Horizontal applications are not permitted. UltraClad flashings shall extend a minimum of 6" (152 mm) beyond the base of the cant strip onto the field plies of the roof. Laps onto granule surfaces require pre-heating/embedment of underlying granule surfacing to ensure proper seaming.
- E. Torch-Method Application:
1. Measure and cut RUBEROID® UltraClad® SBS Flashing Membrane into the required lengths.
 2. Set and align flashing over primed masonry surfaces or installed backer ply. For vertical flashings up to 12" (305 mm) above finished roof, fasten along the top edge 8" (203 mm) o.c. For flashings heights up to 24" (610 mm), fasten along top edge 4" (102 mm) o.c.
 3. Re-roll the fastened but unadhered RUBEROID® UltraClad® flashing to expose underside of membrane. Unroll the membrane into position while heating the underside of roll, underlying non-combustible substrate or backer ply(s), and along the selvage-edge lap area of the previously installed course.
 4. Apply the propane torch flame in an "L" pattern evenly from side to side across the back surface of the membrane and along lap areas until the compound reaches the proper application temperature. Underside of membrane should exhibit a slight sheen but without excessive flow or melting of the back coating. Avoid overheating which may result in damage to or improper adhesion of the membrane.
 5. As an alternate on shorter walls and curb details, RUBEROID® UltraClad® may be back-torched and set into position. Care must be taken to ensure proper heating of all lap areas and underlying backer ply(s) or non-combustible substrates to ensure adequate adhesion.
 6. During installation, RUBEROID® UltraClad® must be carefully pressed into place with lightly dampened sponge, roller mop, or shop rags to ensure full adhesion to the substrate and backer plies. Avoid excessive pressure to softened material that results in surface deformation or substantial distortion of finished waffle pattern.
 7. Apply sufficient pressure at laps to ensure proper seaming and adhesion between heated surfaces with a uniform 1/8" (3 mm) to 1/4" (6 mm) bleed-out of bitumen at all seams. Detail-finish all seams with a round-nose heated trowel to seal foil surfacing at laps. Bleed-out may be dressed with aluminum metalflake powder while hot.
 8. End laps and inside/outside corner wraps where RUBEROID® UltraClad® is lapped onto adjoining pieces of foil-surfaced membrane require removal of the underlying foil skin or priming of the lap area with Matrix™ 307 Premium Asphalt Primer.
 9. To remove foil, after alignment of the lap fold back the overlapping material onto a trowel. Mark the underlying foil surface approximately 1/4" (6 mm) in from the lap edge. Lightly score surface of underlying foil with a sharp knife without cutting the membrane. Carefully heat top surface with a propane torch and remove foil along scored edge. Heat underside of overlapping material and entire lap area prior to finishing the end lap. Apply pressure with damp sponge, mop, or shop rag and seal edges with a heated trowel.

9.06 Reinforced RF, Metal Edge ME, and Black/White BW Flashing Membranes

- A. Lexsuco® RF, ME, and BW Flashing may be used for base flashings on GAFGLAS® gravel- and mineral-surfaced built-up and RUBEROID® SBS modified bitumen roof systems. Lexsuco® flashings are not suitable for use with RUBEROID® APP torch-applied membranes.
- B. Install flashing to smooth, clean, and dry substrates in convenient lengths lapping on sides and ends as indicated below for the specific seaming method used.
- C. Lexsuco® Flashings must be installed over the completed field plies prior to the installation of final surfacing, if any.
- D. Install lower-half of flashing membrane in ASTM D312 Type IV asphalt, Matrix™ 203, or Matrix™ 204 plastic cements extending from top of cant strip to 4" (102 mm) out onto field plies. For flashing heights up to 12" (305 mm), upper-half of flashing membrane may be adhered in hot asphalt or flashing cement to masonry, brick, or concrete substrates, beginning approximately 2" (51 mm) to 3" (76 mm) above the cant strip. Broom-flash to eliminate air pockets and ensure adhesion into hot asphalt or flashing cement. As an alternate method, the upper-half of the flashing may be adhered to the wall with strips of Metalastic® 4" (102 mm) Butyl Tape Sealant. Tape must extend to the top edge of flashing beginning approximately 2" (51 mm) to 3" (76 mm) above the cant strip.
- E. For wood substrates or flashing heights over 12" (305 mm), install upper-half of Lexsuco® flashing membrane to the vertical surface in CA-103 Adhesive or with Metalastic® Butyl Tape Sealant. When used over porous wall substrates, two coats of CA-103 Adhesive may be required.
- F. During installation, all seam areas must be kept clean and free of asphalt, flashing cements, and other contaminants. Vertical end laps and other Lexsuco® membrane-to-membrane laps may be sealed with either of the following three methods:
 - Hot-Air Welding – Laps may be hot-air welded together with hand-held hot-air welding equipment, such as a Leister Triac or Clements Eagle 2000 with 1600-watt welding elements and a weighted silicone-type roller. Flashing material will turn glossy when melted. Care must be taken not to overheat, char, or burn the material from excessive heat. Follow all safety precautions and wear protective equipment and clothing, including heavy, non-flammable, non-melting gloves to protect against burns.
 - Prior to welding any laps, test patches are recommended to determine proper heat settings and required roller pressure using small strips of scrap material. Proper test welds should display a film-tearing bond when separated that exposes the scrim reinforcement. Provide a minimum 2" (51 mm) wide overlap and begin welding once the welder has reached the desired temperature setting. Slide the nozzle under the flap and tack-weld the back inside edge of the lap, applying simultaneous pressure with the roller. Starting from the tack-weld in the center, apply heat and roll the seam from the back to front edges moving diagonally and keeping the roller just behind the welder nozzle. Ensure the lap is fully bonded without voids, especially at angle changes or transitions such as the top or bottom of the cant strip. Probe all seams with an angle-headed seam probe prior to application of finish sealant.

- Seam Adhesive – Laps adhered with CA-103 Adhesive require a minimum 6" (152 mm) overlap. After alignment, mark the location of the lap edge on the underlying sheet and fold back the overlapping material. Apply a thin, uniform coat of adhesive to both surfaces taking care not to apply the adhesive beyond the mark. The adhesive must be allowed to tack-dry to a point where it can be touched without stringing prior to mating surfaces together. Carefully mate the two surfaces together applying pressure with seam roller to the full-width of lap area to ensure complete adhesion and elimination of any voids or air pockets. Remove any adhesive from the outside edge of the lap prior to application of finish sealant.
 - Metalastic® Butyl Tape Sealant – Flashing laps may be adhered together with Metalastic 4" (102 mm) Butyl Tape Sealant. Provide a minimum 6" (152 mm) wide overlap and mark a line 1/4" (6 mm) outside of the lap edge on the underlying sheet. Fold back the overlapping material and align the release film edge of the tape with the mark. This will position the butyl tape itself so that it extends just to the edge of the installed lap. Working from the underside of the tape first, carefully remove a small amount of release film and set the end of the tape. Continue to apply the tape in short lengths along the lap, pulling the release film from the side at an angle and gently applying pressure to the top of the tape taking care to avoid wrinkles, voids, or air pockets. Leave the upper release film in place and gently roll the top surface immediately after setting the tape with a silicone roller to ensure full adhesion.
 - End laps where needed must be a minimum of 1" (25 mm). Fold the overlapping flashing material onto the release film surface of the installed tape and check alignment. Complete the seam by removing the top release film from underneath the flashing, pulling from the side at an angle and simultaneously applying gentle pressure to the top of the flashing while taking care to avoid wrinkles, voids, or air pockets. Roll the top surface of the completed seam with a silicone roller to ensure full adhesion and eliminate any voids or air pockets.
- G. For gravel-surfaced roof systems, install a one-ply strip-in along lower edge of installed Lexsuco® flashing at transition to field membrane with an 8" (203 mm) wide ply of GAFGLAS® FlexPly™ 6 or Ply 4 felt, centered over the lap and set in solid moppings of hot asphalt or trowelings of Matrix™ 203 or 204 flashing cements.
- H. For mineral-surfaced roof systems, strip-in lower edge of Lexsuco® flashing with an 8" (203 mm) wide ply of RUBEROID® SBS granule-surfaced field membrane set in solid moppings of hot asphalt or trowelings of Matrix™ 203 or 204 flashing cements.
- I. Mechanically fasten top edge of Lexsuco® flashing 8" (203 mm) o.c. with termination bar and approved fasteners. Lexsuco® Metal Edge Flashing may be fastened along the top edge through factory-applied metal edge strip and does not require installation of additional termination bar.
- J. All base flashings must be counterflashed. Install metal counterflashing or approved wall covering to extend a minimum of 4" (102 mm) below the top edge of the installed Lexsuco® flashing.

Part 10 – Surfacing

10.01 General

- A. Install all surfacing to provide proper membrane, wind uplift, and fire protection as required by GAF in conjunction with local code, insurance, and project requirements.
- B. Surfacing weights must be considered when determining the load capacity of the structural support system's ability to handle the completed roof installation and other expected loads. GAF is not responsible for determining load capacities, and recommends that a certified professional make any determination relative to load-bearing capacity of a structure.
- C. RUBEROID® HW SMOOTH membrane is not covered with factory-applied surfacing granules and, when used as the finish ply, must receive protective surfacing of asphalt and gravel within 30 days after completion.
- D. RUBEROID® SBS Heat-Welded membranes with factory-applied granule surfacing do not require additional surfacing materials. Do not use liquid surface coatings over these membranes when new.
- E. GAF shall not be liable or responsible for ballast and paver surfacing systems.

10.02 Gravel and Asphalt

- A. GAF does not permit gravel surfacing of RUBEROID® SBS Heat-Welded roof membrane systems on slopes greater than 1:12.
- B. Not less than 400 lb/square (19.5 kg/m²) of gravel or 300 lb/square (14.6 kg/m²) of slag shall be applied in a floodcoat of 60 lb/square (2.9 kg/m²) of hot asphalt.
 - 1. Gravel at the time of application shall be hard, durable, opaque, and free of clay, loam, sand, or other foreign substances, and comply with ASTM D1863.
- C. Asphalt shall conform to the latest revision of ASTM D312. ASTM D312 Type III or IV asphalt may be used on slopes up to 1/2:12. ASTM D312 Type IV must be used on slopes of 1/2:12 or greater.
- D. No more asphalt shall be applied at one time than can be immediately covered with gravel or slag.

10.03 Walkways

- A. Walkways for normal rooftop-traffic can be constructed from one or more layers of RUBEROID® SBS Heat-Welded membrane. These types of walkways are not intended for plaza deck or patio-type use.
- B. For normal-to-moderate traffic conditions, torch-apply one layer of RUBEROID® HW GRANULE membrane over the completed field plies prior to application of final surfacing.
- C. For heavier traffic conditions such as around rooftop equipment, hatches, and doorways, a two-ply walkpad can be constructed from RUBEROID® SBS Heat-Welded membranes with the use of an additional layer of RUBEROID® HW SMOOTH as the first ply in the respective walkpad assembly.
- D. Walkway sections should be no longer than 10' (3 m), with a 6" (152 mm) minimum gap between each section to allow for drainage.
- E. Surface the roof area around and between the walkway sections if additional surfacing is added to the completed membrane.

Part 11 – Cold-Weather Application Precautions

- A. In cooler weather, unrolling and relaxing modified bitumen rolls and base sheet rolls prior to installation will reduce the potential for wrinkles to form in the finished roof. The rolls can be cut into shorter lengths for easier handling when rerolling and installing.
- B. Special care is required when installing GAF roof membranes at temperatures below 45°F (7.2°C):
 - 1. The roof substrate must be dry. There must be no ice, dew, or water.
 - 2. All membrane rolls, adhesives, and coatings must be stored for at least overnight at a minimum temperature of 55°F (12.8°C) prior to their application. All water-based coatings must be protected from freezing at all times.
 - 3. Remove rolls from the heated storage only as they are being installed. Install membrane rolls immediately after removal from storage to avoid membrane cooling. Modified rolls must be at least 45°F (7.2°C) at time of application.
 - 4. For mop-applied SBS membranes, the asphalt temperature at point of application must be maintained at the asphalt's EVT or 425° F (218°C), whichever is greater, with a rolling bank (puddle) of mopping asphalt across the full width of the roll. For non-modified glass felts, the asphalt temperature at point of application must be maintained at the asphalt's EVT \pm 25°F (\pm 13.9°C). The use of insulated asphalt-handling equipment is recommended in cold weather. Do not overheat the asphalt to try to offset the cold ambient temperature. If the proper asphalt application temperature can not be consistently maintained, roofing must be discontinued. Be aware that cool, windy conditions will cause asphalt heat loss to occur at a rate equivalent to a lower ambient temperature.
 - 5. Mopping must not precede the roll by more than 5' (1.52 m).
 - 6. If insulation is being set in mopping asphalt, it must be set quickly while the asphalt is still hot and fluid. Use the minimum insulation size available. At no time should boards larger than 4' x 4' (1.22 m x 1.22 m) be set in hot asphalt.
 - 7. Do not overheat RUBEROID® SBS Heat-Weld rolls to compensate for cold ambient temperatures.

Roofing System Maintenance

General

The building owner has a responsibility to provide necessary maintenance for the GAF roofing system and related building components. Failure to provide necessary maintenance may result in deterioration of the roofing system that could otherwise have been avoided. Repair of such deterioration is not covered by a roofing-system guarantee and can result in costly repairs for the building owner. In certain instances, such deterioration can be so extensive that the roofing system can no longer be repaired and maintained and, if a guarantee is in effect for the roofing system, it may be cancelled in part or in whole.

What “wears out” roofs?

- Exposure – Either long-term exposure to the elements (sun, water, freeze-thaw) or shorter-term exposure to damaging air pollutants and chemicals
- Structural Movement – Such as building settlement or expansion/contraction not accommodated by the roofing system
- Biological Growth – Such as vegetation in areas of standing water or algae
- Not Fixing Problems Promptly – These can add up to a much shorter roof life, e.g., if a small problem is not repaired, then a large amount of insulation can be damaged
- Forgetting About Maintenance – This is perhaps the single biggest cause of premature roof failure
- Change in the Use of the Building – e.g., an increase in the interior relative humidity of a building can cause severe condensation problems within the roofing system

What can cause immediate problems?

- Extreme Weather – Lightning, high winds, hail, and drenching rains that overflow the flashing heights
- Equipment Additions – Improperly added equipment or other items improperly added on the roof (items added by tenants are a very common source of roofing problems)
- Trade Damage – Punctures, holes, etc., caused by trades other than your roofing contractor
- Unintended Abuse – Vandalism or accidental damage; even a small hole can let a large amount of water into the roofing system

10-Point Scheduled Maintenance Checklist

In order to ensure that a GAF roofing system will continue to perform to its fullest, GAF has developed a 10-point Scheduled Maintenance Checklist for property owners with GAF-guaranteed roof systems. This maintenance checklist is intended to address conditions commonly found on most buildings.

What	How	Why
1. Maintain Records	<p>Keep a file of all records relating to this roof, including:</p> <ul style="list-style-type: none"> • GAF guarantee • Inspection reports • Repair and maintenance bills • Original construction drawings, specifications, and invoices 	<ul style="list-style-type: none"> • These records can be very helpful if you need to have repairs made or have additional equipment added to the roof. • Also helpful when it's time to reroof—since you know what's up on the roof and what's been done.
2. Conduct Routine Inspections	<p>At least once per year (twice per year is optimal, typically in the spring and fall).</p> <p>An Inspection Maintenance Checklist is provided with NDG Guarantees. Refer to points 3-10 below.</p>	<ul style="list-style-type: none"> • It's simple, really: in the spring, you want to check for any maintenance items that can be scheduled for the roofing system. In the fall, you're checking to make sure the roof is ready to go through the winter months.
3. Inspect After Severe Weather	<p>Always inspect the roof for damage after severe weather such as hailstorms, heavy rains, high winds, etc.</p>	<ul style="list-style-type: none"> • Just because water is not coming in doesn't mean that the roof hasn't been damaged. • The sooner you repair any damage, the smaller the repair cost.
4. Repair Correctly	<p>All roofing repairs must be performed by a GAF Authorized, Master, or Master Select™ Roofing Contractor, including repairs for non-guaranteed conditions.</p> <p>Make repairs with GAF materials, following our current repair guidelines for the type and quality of roof installed.</p>	<ul style="list-style-type: none"> • Remember, improper repairs are a common cause of roof problems and are easy to avoid!
5. Keep Roof Clean & Free of Debris	<p>Always remove debris from roof, such as:</p> <ul style="list-style-type: none"> • Leaves, branches, dirt, rocks, bottles • Debris and trash from other trades, etc. <p>Keep gutters, downspouts, drains, scuppers, and the surrounding roof areas clean to ensure proper drainage.</p>	<ul style="list-style-type: none"> • Trash and debris can not only cause harm (such as punctures) to the roofing system, but can also be a safety hazard; this can range from simple "trip" hazards to potentially overloading the structure with extensive ponding water from clogged drains.
6. Keep Metal In Good Condition	<p>Examine all metal flashings, counterflashings, expansion joints, and pitch pockets for:</p> <ul style="list-style-type: none"> • Rust • Detachment or damage • Deteriorated sealant <p>Reattach loose metalwork, replace sealant as necessary; repair metal as necessary; and prepare and paint any rusted metal.</p>	<ul style="list-style-type: none"> • Metal components on a roof are a common point of water entry. • It doesn't matter how good your roofing system is if the adjacent metal is letting water into the building.

What	How	Why
<p>7. Keep Masonry In Good Condition</p>	<p>Examine masonry walls and copings for:</p> <ul style="list-style-type: none"> • Cracks and bad mortar joints • Deteriorated sealant • Loose masonry/coping stones • Indications of water absorption <p>Repair all such conditions to prevent water infiltration.</p>	<ul style="list-style-type: none"> • Water leaks from masonry are often incorrectly attributed to the roofing system, so keeping any walls, copings, etc. watertight also goes a long way to keeping the building leak-free.
<p>8. Maintain Rooftop Equipment</p>	<p>Examine rooftop equipment for any problems that may allow water infiltration, including:</p> <ul style="list-style-type: none"> • Air conditioners, vents, and duct work • Equipment stands or screens • Skylights • Satellite dishes and antennas 	<ul style="list-style-type: none"> • Just as the roof needs maintenance, so does the equipment that's on the roof. • Be sure to follow the manufacturer's maintenance recommendations provided and always check the roof after any service calls to make sure the roof hasn't been accidentally damaged.
<p>9. Maintain Roof Coating If Present</p>	<p>Eliminate any spillage of coolant, oils, grease, etc., and repair roof membrane if affected.</p> <p>Examine protective coatings and recoat any cracked, flaked, blistered, or worn areas with a compatible GAF roof coating.</p>	<ul style="list-style-type: none"> • Roof coatings protect the membrane from long-term exposure to the elements and, if reflective, also provide great cooling benefits for the building. Recoating of these materials protects the membrane and allows it to keep doing its job.
<p>10. Minimize Rooftop Traffic</p>	<p>Minimize rooftop traffic by limiting access to necessary personnel only.</p> <p>Maintain a roof access log so that you can ascertain who has been on the roof in the event of damage to the roof from other trades.</p>	<ul style="list-style-type: none"> • Roofs are meant to keep water out and, if properly designed, can even act as another work area. But most roofs are not designed for this, and repeated, long-term traffic can wear out a roof. • The easiest way to prevent this type of damage is to keep people off the roof who don't belong there!

Other conditions may exist that require special maintenance considerations, and it is the building owner's responsibility to ensure that any maintenance program followed for a particular building is adequate and appropriate.

NOTES

NOTES

NOTES

NOTES



gaf.com

©2016 GAF 1/16 #205 • COMGN282

