

**GAF**

# Residential Reference Guide

The one-stop guide from North America's Largest Roofing Manufacturer



GAF shingles and roof accessories are made to work together. They provide a system that's built to protect homes—so the people who live inside them can enjoy what matters most.

**GAF**









We protect what matters most™

	LRS	Pages
Technology Index		2
GAF Lifetime <sup>†</sup> Roofing System	LRS	4–5
GAF Shingles		6–19
<b>Timberline<sup>®</sup> Lifetime<sup>†</sup> Shingles Collection LRS</b>		
Timberline <sup>®</sup> HDZ <sup>™</sup>	●	8
Timberline <sup>®</sup> UHD	●	9
<b>Lifetime<sup>†</sup> Designer Shingles<sup>®</sup> Collection LRS</b>		
Grand Canyon <sup>®</sup>	●	11
Grand Sequoia <sup>®</sup>	●	12
Camelot <sup>®</sup> II	●	12
Woodland <sup>®</sup>	●	13
Slateline <sup>®</sup>	●	13
<b>3-Tab Shingle Collection (Excluded from LRS)</b>		
Marquis WeatherMax <sup>®</sup>		14–15
Shingle Specifications Chart		16–17
GAF Roofing Accessories	LRS	18–23
Leak Barriers	●	19
Roof Deck Protection	●	20
Starter Strip Shingles	●	21
Cobra <sup>®</sup> Attic Ventilation	●	22
Ridge Cap Shingles	●	23
Other Products		24–27
Master Flow <sup>®</sup> Ventilation Products		24
WeatherSide <sup>™</sup> Fiber-Cement Siding		25
ThermaCal <sup>®</sup> Building Envelope Insulation Panels		26
LIBERTY <sup>™</sup> Self-Adhering Roofing System		27



# Trust the diamonds

Whether it's warranty coverage that gives homeowners peace of mind or technology that makes their roof look and perform its best, there's a GAF diamond badge behind it.

	Install any GAF Lifetime <sup>†</sup> Shingle and get a <b>Lifetime<sup>†</sup> Limited Warranty</b> on your qualifying shingle. Install any GAF Lifetime Shingle and at least 3 qualifying GAF Accessories, and get a <b>Lifetime<sup>†</sup> Limited Warranty</b> on your qualifying GAF products.
	<b>GAF Advanced Protection<sup>®</sup> Shingle Technology</b> uses highly advanced design and manufacturing techniques to produce cutting-edge roofing products.
	<b>Dura Grip<sup>™</sup> Adhesive</b> helps protect your roof investment from winds and wind-driven rain.
	<b>StainGuard Plus<sup>™</sup> Algae Protection<sup>1</sup></b> featuring Time-Release Technology is a 25-year limited warranty against blue-green algae discoloration.
	<b>StainGuard<sup>®</sup> Algae Protection<sup>2</sup></b> is a 10-year limited warranty against blue-green algae discoloration.
	<b>LayerLock<sup>™</sup> Technology</b> is a proprietary technology which mechanically fuses the common bond between overlapping shingle layers.
	<b>WindProven<sup>™</sup> Limited Wind Warranty<sup>3</sup></b> is a 15-year limited wind warranty with no maximum wind speed limitation — available when you install the LayerLock <sup>™</sup> -labeled Shingles as well as GAF starter strips, roof deck protection, ridge cap shingles, and leak barrier or attic ventilation.
	<b>30-Year Limited Warranty Term<sup>4</sup></b> gives homeowners protection they can trust.

<sup>†</sup> Lifetime refers to the length of warranty coverage provided and means as long as the original individual owner(s) of a single-family detached residence [or eligible second owner(s)] owns the property where the qualifying GAF products are installed. For other owners/structures, Lifetime coverage is not applicable. For Lifetime coverage on shingles only see *GAF Shingle & Accessory Limited Warranty* for complete coverage and restrictions. For Lifetime coverage on shingles and accessories see *GAF Roofing System Limited Warranty* for complete coverage and restrictions. For installations not eligible for the *GAF Roofing System Limited Warranty*, see the *GAF Shingle & Accessory Limited Warranty*. Visit [gaf.ca/LRS](http://gaf.ca/LRS) for qualifying GAF products.

<sup>1</sup> StainGuard Plus<sup>™</sup> Time-Release Technology is available only on Shingles sold in packages bearing the StainGuard Plus<sup>™</sup> logo. Products with StainGuard Plus<sup>™</sup> Time-Release Technology are covered by a 25-year limited warranty against blue-green algae discoloration. See *GAF Shingle & Accessory Limited Warranty* for complete coverage and restrictions.

<sup>2</sup> StainGuard<sup>®</sup> algae protection is available only on shingles sold in packages bearing the StainGuard<sup>®</sup> logo. Products with StainGuard<sup>®</sup> algae protection are covered by a 10-year limited warranty against blue-green algae discoloration. See *GAF Shingle & Accessory Limited Warranty* for complete coverage and restrictions.

<sup>3</sup> For installations not eligible for the *GAF Roofing System Limited Warranty*, see the *GAF Shingle and Accessory Limited Warranty* for complete coverage and restrictions. Visit [gaf.ca/LRS](http://gaf.ca/LRS) for qualifying GAF products.

<sup>4</sup> See *GAF Shingle & Accessory Limited Warranty* for complete coverage and restrictions.

# Trust the system that's built to protect

A roof is so much more than shingles. It's layers of protection, working together to help keep your home safe from wind, rain, snow, and even sun.

Install any GAF Lifetime<sup>†</sup> Shingle and at least 3 qualifying GAF Accessories and get a Lifetime<sup>†</sup> limited warranty on your qualifying GAF products plus non-prorated coverage for the first 10 years. For even stronger coverage, ask your GAF factory-certified contractor<sup>1</sup> about enhanced GAF warranties.

Visit [gaf.ca/LRS](http://gaf.ca/LRS) for a list of qualifying GAF products.

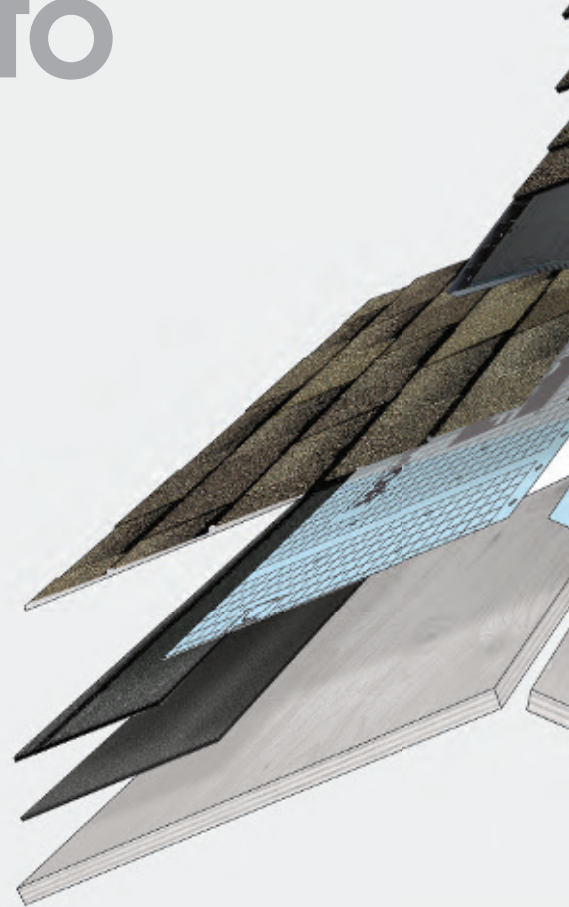

Visit [gaf.ca/Lifetime](http://gaf.ca/Lifetime)



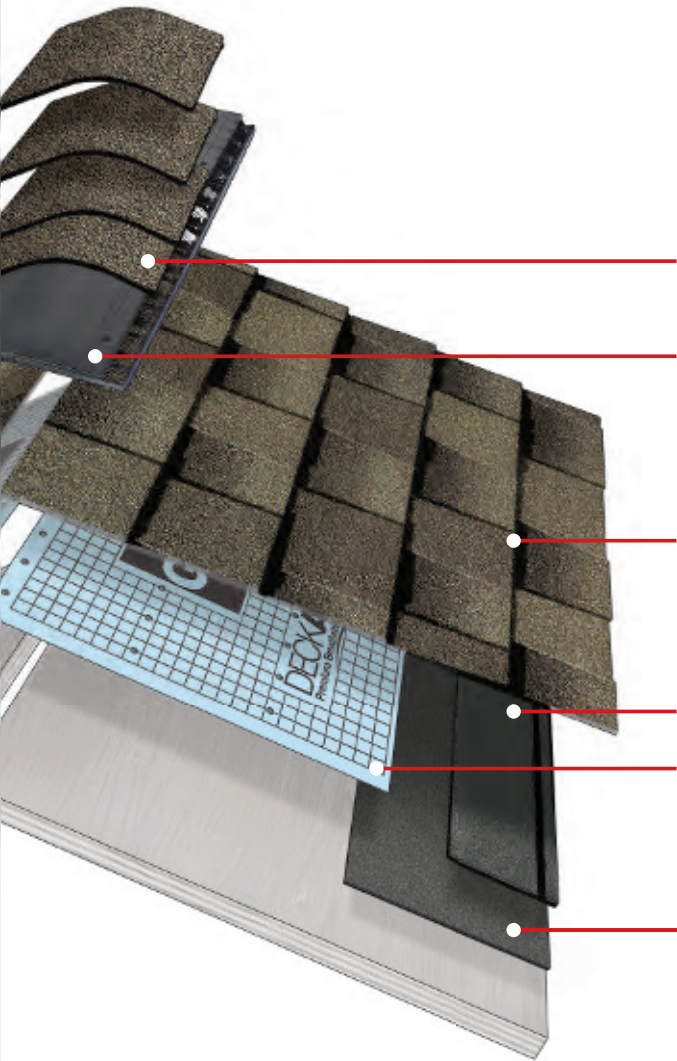

- Ridge Cap Shingles

- Cobra® Attic Ventilation

- Lifetime† Shingles

- Starter Strip Shingles

- Roof Deck Protection

- Leak Barrier



† Lifetime refers to the length of warranty coverage provided and means as long as the original individual owner(s) of a single-family detached residence [or eligible second owner(s)] owns the property where the qualifying GAF products are installed. For other owners/structures, Lifetime coverage is not applicable. Lifetime coverage on shingles requires the use of GAF Lifetime Shingles only. Lifetime coverage on shingles and accessories requires the use of any GAF Lifetime Shingle and at least 3 qualifying GAF Accessories. See *GAF Roofing System Limited Warranty* for complete coverage and restrictions. Visit [gaf.ca/LRS](http://gaf.ca/LRS) for qualifying GAF products. For installations not eligible for the *GAF Roofing System Limited Warranty*, see the *GAF Shingle & Accessory Limited Warranty*.

† Contractors enrolled in GAF certification programs are not employees or agents of GAF, and GAF does not control or otherwise supervise these independent businesses. Contractors may receive benefits, such as loyalty rewards points and discounts on marketing tools from GAF for participating in the program and offering GAF enhanced warranties, which require the use of a minimum amount of GAF products.

# Timberline® Lifetime† Shingles Collection

More homeowners in North America rely on Timberline® Shingles than any other brand. They offer just the right combination of beauty, performance, and reliability.

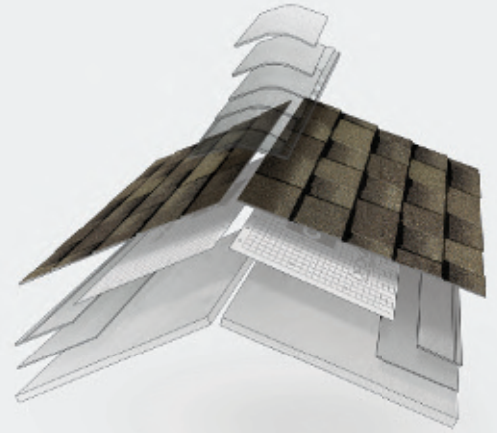

<p><b>Timberline® HDZ™</b> pg 7-8</p>			<p>America's #1-selling shingle—now featuring the industry's widest nail zone</p>
<p><b>Timberline® UHD</b> pg 7 &amp; 9</p>			<p>For a thick ultra-dimensional wood-shake look in an asphalt shingle</p>

For specifications see pages 16-17



For the full collection visit [gaf.ca/Timberline](http://gaf.ca/Timberline)



<sup>1</sup> 15-year WindProven™ limited wind warranty on GAF Shingles with LayerLock™ Technology requires the use of GAF starter strips, roof deck protection, ridge cap shingles, and leak barrier or attic ventilation. See *GAF Roofing System Limited Warranty* for complete coverage and restrictions. Visit [gaf.ca/LRS](http://gaf.ca/LRS) for qualifying GAF products.

# Availability

Timberline® HDZ™		1	2	3	4
<b>Most Popular Colours:</b>					
Barkwood		•	•	•	•
Canadian Driftwood		•	•	•	•
Charcoal		•	•	•	•
Hickory		•	•	•	•
Mission Brown		•	•	•	•
Pewter Gray		•	•	•	•
Shakewood		•	•	•	•
Weathered Wood		•	•	•	•
<b>Regional Colours:</b>					
Birchwood <sup>1</sup>			•	•	•
Hunter Green		•	•		
Slate		•	•		•



Timberline® UHD		1	2
<b>Most Popular Colours:</b>			
Barkwood		•	• <sup>2</sup>
Charcoal		•	• <sup>2</sup>
Pewter Gray			• <sup>2</sup>
Shakewood		•	• <sup>2</sup>
Slate		•	• <sup>2</sup>
Weathered Wood		•	• <sup>2</sup>



<sup>1</sup>Limited availability.

<sup>2</sup>Timberline® UHD Shingles in these areas have the Dual Shadow Line feature.

**GAF** **Timberline® HDZ™**  
High Definition® Lifetime® Shingles



Timberline® Shingles protect millions of families nationwide with great value and a genuine wood-shake look. Peace of mind has never looked so good.



Timberline® Shingles LRS

For more details visit [gaf.ca/HDZ](http://gaf.ca/HDZ)

<sup>1</sup> 15-year WindProven™ limited wind warranty on Timberline® HDZ™ Shingles requires the use of GAF starter strips, roof deck protection, ridge cap shingles, and leak barrier or attic ventilation. See *GAF Roofing System Limited Warranty* for complete coverage and restrictions. Visit [gaf.ca/LRS](http://gaf.ca/LRS) for qualifying GAF products.



**GAF** **Timberline® UHD**  
Ultra High Definition® Lifetime® Shingles

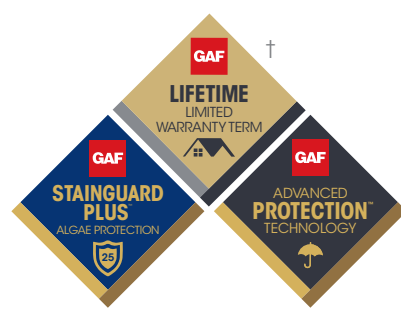

Proprietary colour blends and enhanced shadow effects create eye-catching dimensionality on a thick shingle while StainGuard Plus™ Time-Release Technology helps prevent blue-green algae stains.

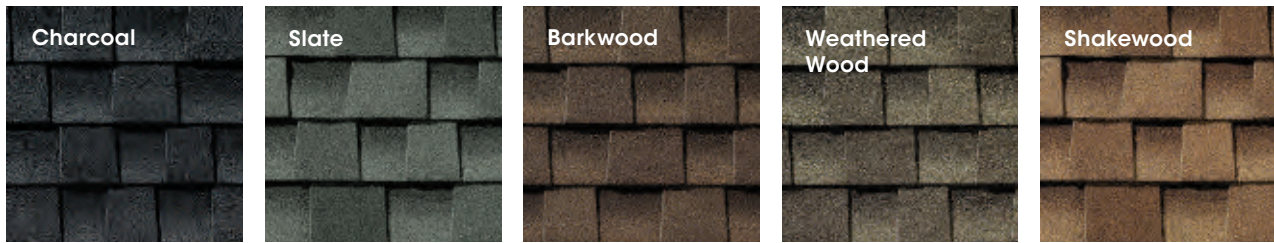

For more details visit [gaf.ca/UHD](http://gaf.ca/UHD)

**Dual Shadow Lines** add enhanced dimensionality and take your home's roof—and curb appeal—to new heights. The impact is unmistakable!

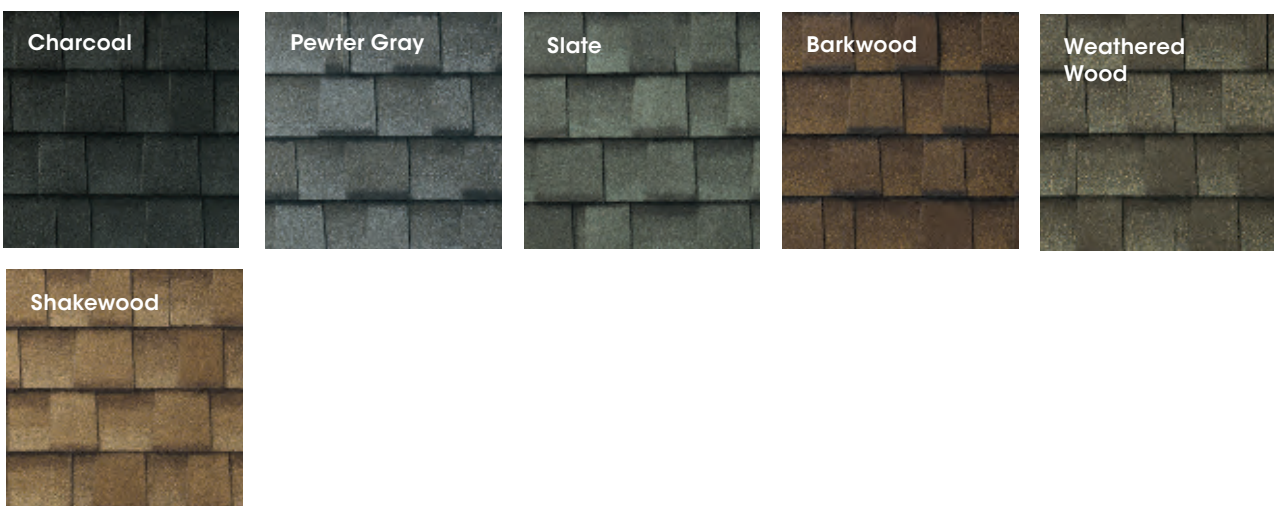

For more details visit [gaf.ca/DualShadow](http://gaf.ca/DualShadow)







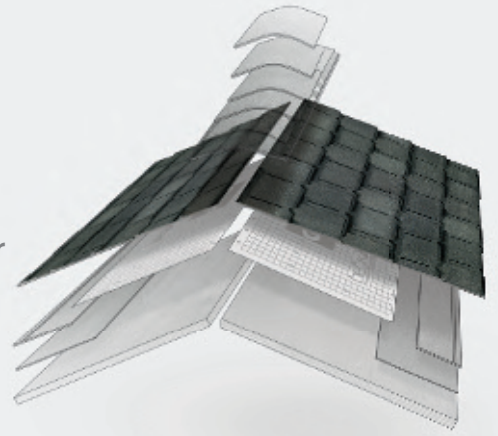



<sup>1</sup> Timberline® UHD Shingles with the Dual Shadow Line feature are only available in certain areas; see chart on page 7 for regional availability.  
NOTE: It is difficult to reproduce the colour clarity and actual colour blends of these products. Before selecting your colour, please ask to see several full-size shingles.

# Lifetime<sup>†</sup> Designer Shingles Collection

Featuring sophisticated designs, custom colour palettes, and high performance, GAF Lifetime<sup>†</sup> Designer Shingles are also only a fraction of the cost of traditional slate or wood shakes.



## Designer Lifetime<sup>†</sup> Shingles

<p><b>Grand Canyon<sup>®</sup></b> pg 11</p>	 	<p>Rugged sophistication with striking depth</p>
<p><b>Grand Sequoia<sup>®</sup></b> pg 12</p>	 	<p>Rustic charm meets 21st-century style</p>
<p><b>Camelot<sup>®</sup> II</b> pg 12</p>	 	<p>Contemporary slate-inspired elegance in an asphalt shingle</p>
<p><b>Woodland<sup>®</sup></b> pg 13</p>	 	<p>The beauty of natural wood shakes in an asphalt shingle</p>
<p><b>Slateline<sup>®</sup></b> pg 13</p>	 	<p>An asphalt shingle with the dramatic look of slate</p>

For specifications see pages 16-17



For the full collection visit [gaf.ca/Designer](http://gaf.ca/Designer)



**GAF** **GrandCanyon**<sup>®</sup>  
Designer Lifetime<sup>†</sup> Shingles

The ultimate choice for a rugged wood-shake look, offering incredible depth and dimension.



For more details visit [gaf.ca/GrandCanyon](http://gaf.ca/GrandCanyon)

**NOTE:** It is difficult to reproduce the colour clarity and actual colour blends of these products. Before selecting your colour, please ask to see several full-size shingles.

**GAF** Grand Sequoia<sup>®</sup>  
Designer Lifetime<sup>†</sup> Shingles

Artisan-crafted shapes combined with oversized tabs result in a sophisticated beauty unmatched by typical shingles.



For more details visit [gaf.ca/GrandSequoia](http://gaf.ca/GrandSequoia)

Lifetime<sup>†</sup> Designer Shingles LRS

**GAF** Camelot<sup>®</sup> II  
Designer Lifetime<sup>†</sup> Shingles

Designed to complement your home's exterior colour scheme, these shingles give your home the luxury look you want without breaking your budget.



For more details visit [gaf.ca/CamelotII](http://gaf.ca/CamelotII)

**GAF** Woodland<sup>®</sup>  
Designer Lifetime<sup>†</sup> Shingles

The stylish look of hand-cut European shingles at an incredibly affordable price.



For more details visit [gaf.ca/Woodland](http://gaf.ca/Woodland)

**GAF** Slateline<sup>®</sup>  
Designer Lifetime<sup>†</sup> Shingles

Bold shadow lines and tapered cut-outs create the look of slate at a fraction of the cost.

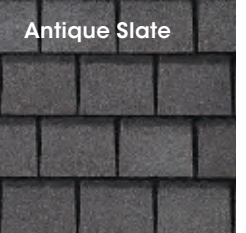

For more details visit [gaf.ca/Slateline](http://gaf.ca/Slateline)

NOTE: It is difficult to reproduce the colour clarity and actual colour blends of these products. Before selecting your colour, please ask to see several full-size shingles.

# 3-Tab Shingles

The perfect choice for first-time buyers, these shingles add beauty and performance to any roof.

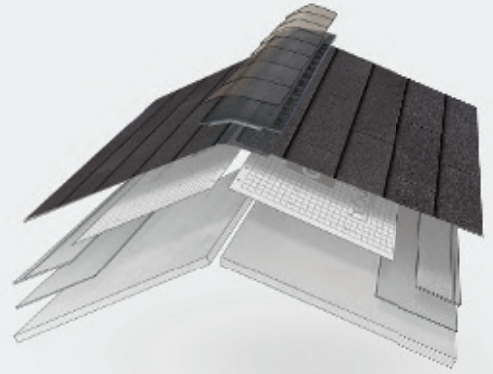

<p><b>Marquis WeatherMax®</b> pg 14-15</p>			<p>Excellent performance and a vivid design make for an exceptional investment</p>
--	--	--	--

For specifications see pages 16-17

## Colour Availability

Marquis WeatherMax®		1	2	3	4
Autumn Brown		•	•	•	•
Charcoal		•	•	•	•

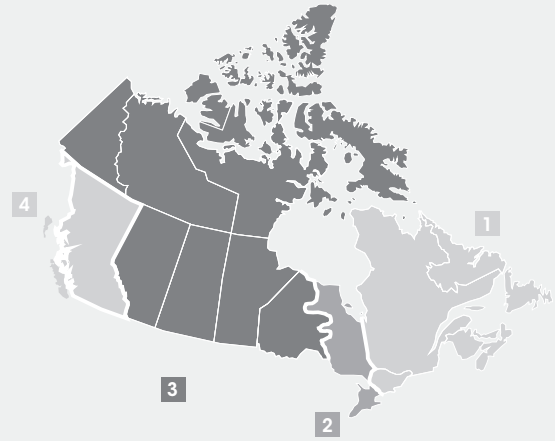

3-Tab Shingles (Excluded from LRS)



For the full collection visit [gaf.ca/3Tab](http://gaf.ca/3Tab)



# **GAF** MarquisWeatherMax<sup>®</sup> 3-Tab Shingles





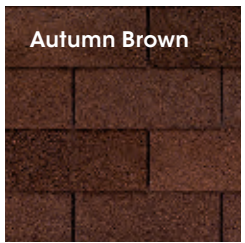













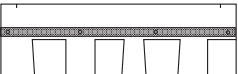























Outstanding performance  
and traditional appeal.

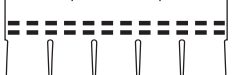

3-Tab Shingles (Excluded from LRS)

**NOTE:** It is difficult to reproduce the colour clarity and actual colour blends of these products. Before selecting your colour, please ask to see several full-size shingles.

# Shingle Specifications

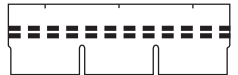
Shingle	Warranty	Technology	Shingle Construction
<b>Timberline® Lifetime<sup>†</sup> Shingles Collection</b>			
<b>Timberline® HDZ™</b>	 <sup>1</sup>  <sup>2</sup>	 <sup>3</sup>  <sup>3</sup>  <sup>3</sup>  <sup>3</sup>	
<b>Timberline® UHD</b>	 <sup>1</sup>	 <sup>4</sup>  <sup>3</sup>  <sup>3</sup>	
<b>Lifetime<sup>†</sup> Designer Shingles Collection</b>			
<b>Grand Canyon®</b>	 <sup>1</sup>	 <sup>3</sup>  <sup>3</sup>  <sup>3</sup>	
<b>Grand Sequoia®</b>	 <sup>1</sup>	 <sup>3</sup>  <sup>3</sup>  <sup>3</sup>	
<b>Woodland®</b>	 <sup>1</sup>	 <sup>3</sup>  <sup>3</sup>  <sup>3</sup>	
<b>Camelot® II</b>	 <sup>1</sup>	 <sup>3</sup>  <sup>3</sup>  <sup>3</sup>	
<b>Slateline®</b>	 <sup>1</sup>	 <sup>3</sup>  <sup>3</sup>  <sup>3</sup>	
<b>3-Tab Shingle</b>			
<b>Marquis WeatherMax®</b>	 <sup>1</sup>	 <sup>3</sup>  <sup>3</sup>	

<sup>1</sup> Lifetime refers to the length of warranty coverage provided and means as long as the original individual owner(s) of a single-family detached residence [or eligible second owner(s)] owns the property where the qualifying GAF products are installed. For other owners/structures, Lifetime coverage is not applicable. Lifetime coverage on shingles requires the use of GAF Lifetime Shingles only. Lifetime coverage on shingles and accessories requires the use of any GAF Lifetime Shingle and at least 3 qualifying GAF Accessories. See *GAF Roofing System Limited Warranty* for complete coverage and restrictions. Visit [gaf.co/LRS](http://gaf.co/LRS) for qualifying GAF products. For installations not eligible for the *GAF Roofing System Limited Warranty*, see the *GAF Shingle & Accessory Limited Warranty*.

<sup>2</sup> See *GAF Shingle & Accessory Limited Warranty* for complete coverage and restrictions.

<sup>3</sup> 15-year WindProven™ limited wind warranty on GAF Shingles with LayerLock™ Technology requires the use of GAF Starter Strips, Roof Deck Protection, Ridge Cap Shingles, and Leak Barrier or Attic Ventilation. See *GAF Roofing System Limited Warranty* for complete coverage and restrictions. Visit [gaf.co/LRS](http://gaf.co/LRS) for qualifying GAF products. For installations not eligible for the WindProven™ limited wind warranty, see *GAF Shingle & Accessory Limited Warranty* for complete coverage and restrictions.



Approximate Physical Attributes					Codes								
					Fire	Wind		National				Regional	
Pieces/Square	Bundles/Square	Nails/Square <sup>3</sup>	Exposure	Dimensions	UL Listed to ANSI/UL 790 Class A and CAN/ULC-S107 Class A	ASTM D7158, Class H	ASTM D3161, Class F	ASTM D3018 Type 1	ASTM D3462 <sup>6</sup>	Classified in accordance with ICC-ES AC438	CSA A123.5	ICC-ES ESR-1475	ICC-ES ESR-3267
64	3	256	5 5/8" (143 mm)	13 1/4" x 39 3/8" (337 x 1,000 mm)	●	●	●	●	●	●	●	●	●
64	4	256	5 5/8" (143 mm)	13 1/4" x 39 3/8" (337 x 1,000 mm)	●	●	●	●	●	●	●	●	●
72	6	360	5" (127 mm)	17" x 40" (432 x 1,016 mm)	●	●	●	●	●	●	●	●	●
70	5	360	5" (127 mm)	17" x 40" (432 x 1,016 mm)	●	●	●	●	●	●	●	●	●
56	4	280	6 1/2" (165 mm)	17" x 40" (432 x 1,016 mm)	●	●	●	●	●	●	●	●	●
56	4	280	7 1/2" (191 mm)	17" x 34 1/2" (432 x 876 mm)	●	●	●	●	●	●	●	●	●
48	3	288	7 1/2" (191 mm)	17" x 40" (432 x 1,016 mm)	●	●	●	●	●	●	●	●	●
79	3	316	5" (127 mm)	12" x 36" (305 x 914 mm)	●	●	●	●	●	●	●	●	●

<sup>3</sup> StainGuard® algae protection is available only on shingles sold in packages bearing the StainGuard® logo. Products with StainGuard® algae protection are covered by a 10-year limited warranty against blue-green algae discoloration. See *GAF Shingle & Accessory Limited Warranty* for complete coverage and restrictions.

<sup>4</sup> StainGuard Plus™ Time-Release Technology is available only on shingles sold in packages bearing the StainGuard Plus™ logo. Products with StainGuard Plus™ Time-Release Technology are covered by a 25-year limited warranty against blue-green algae discoloration. See *GAF Shingle & Accessory Limited Warranty* for complete coverage and restrictions.

<sup>5</sup> Steeper slopes and maximum wind warranties may require more nails.

<sup>6</sup> Periodically tested by independent and internal labs to ensure compliance with ASTM D3462 at time of manufacture.



# Roofing Accessories

Install any GAF Lifetime<sup>†</sup> Shingle and at least 3 qualifying GAF Accessories and you'll get a Lifetime<sup>†</sup> limited warranty on your qualifying GAF products.

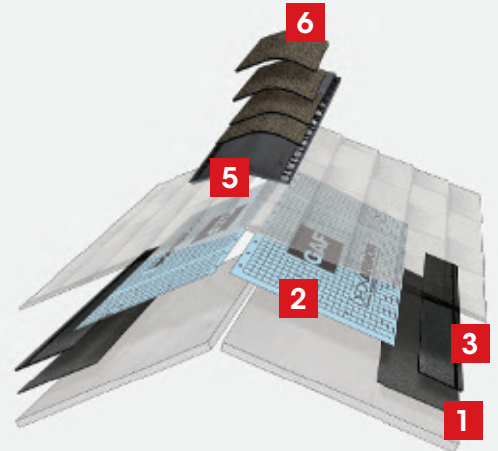

Visit [gaf.ca/LRS](http://gaf.ca/LRS) for a list of qualifying products.

<p><b>Leak Barriers</b></p> <p>pg 19</p>		<p>Help prevent leaks caused by wind-driven rain and ice dams</p>
<p><b>Roof Deck Protection</b></p> <p>pg 20</p>		<p>Helps shield the roof deck from moisture infiltration</p>
<p><b>Starter Strip Shingles</b></p> <p>pg 21</p>		<p>Help guard against shingle blow-offs at the eaves and rakes</p>
<p><b>Cobra<sup>®</sup> Attic Ventilation</b></p> <p>pg 22</p>		<p>Helps reduce attic moisture and heat</p>
<p><b>Ridge Cap Shingles</b></p> <p>pg 23</p>		<p>The finishing touch that helps defend against leaks at the hips and ridges</p>

<sup>†</sup> Lifetime refers to the length of warranty coverage provided and means as long as the original individual owner(s) of a single-family detached residence [or eligible second owner(s)] owns the property where the qualifying GAF products are installed. For other owners/structures, Lifetime coverage is not applicable. Lifetime coverage on shingles requires the use of GAF Lifetime Shingles only. Lifetime coverage on shingles and accessories requires the use of any GAF Lifetime Shingle and at least 3 qualifying GAF Accessories. See *GAF Roofing System Limited Warranty* for complete coverage and restrictions. Visit [gaf.ca/LRS](http://gaf.ca/LRS) for qualifying products. For installations not eligible for the *GAF Roofing System Limited Warranty*, see the *GAF Shingle & Accessory Limited Warranty*.



For the full collection visit [gaf.ca/System](http://gaf.ca/System)



# Leak Barriers

Help prevent leaks caused by wind-driven rain and ice dams.

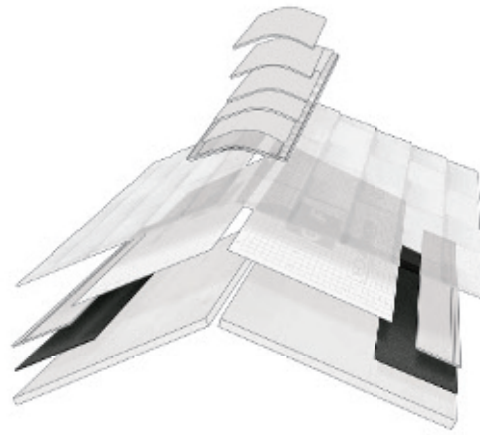

<p><b>StormGuard®</b></p>		<ul style="list-style-type: none"> <li>▪ Film-surfaced peel and stick underlayment for asphalt shingles and metal roofing</li> <li>▪ Self-seals fasteners and helps protect vulnerable areas of the roof</li> <li>▪ 250°F (121.1 °C) high-temperature design. Meets or exceeds the performance criteria of ASTM D1970</li> <li>▪ 2 Sq. (200 ft<sup>2</sup> [18.58 m<sup>2</sup>]) roll size - excludes laps</li> </ul>
<p><b>WeatherWatch®</b></p>		<ul style="list-style-type: none"> <li>▪ Mineral-surfaced peel and stick underlayment for asphalt shingles</li> <li>▪ Self-seals fasteners and helps protect vulnerable areas of the roof</li> <li>▪ Meets or exceeds the performance criteria of ASTM D1970</li> <li>▪ 2 Sq. (200 ft<sup>2</sup> [18.58 m<sup>2</sup>]) &amp; 1.5 Sq. (150 ft<sup>2</sup> [13.94 m<sup>2</sup>]) roll sizes - excludes laps</li> </ul>

## Leak Barrier Application Recommendations:

Strongly recommended around	Optional around	Required by code at <sup>1</sup>	Region <sup>1</sup>
1. Penetrations	5. Hips & rake edges	7. Eaves in colder zones <i>Recommended in warmer zones</i>	1. Colder zone
2. Skylights	6. Ridges		2. Warmer zone
3. Valleys & dormers	4. Flashings & transitions		

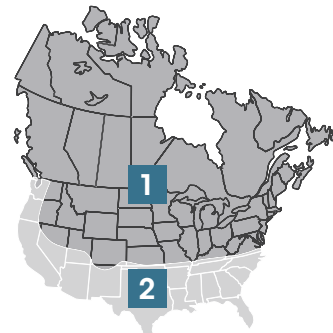
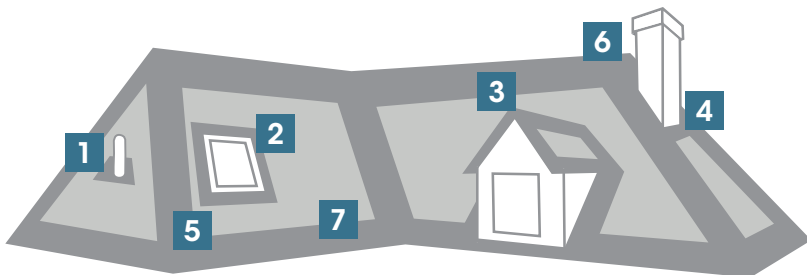

For the full collection visit [gaf.ca/LeakBarriers](http://gaf.ca/LeakBarriers)

<sup>1</sup> Always check local building codes for requirements in your area.

<sup>2</sup> To qualify for this coverage, must be installed with GAF Lifetime Shingles and at least 3 qualifying GAF Accessories. See [gaf.ca/LRS](http://gaf.ca/LRS) for qualifying products and see *GAF Roofing System Limited Warranty* for complete coverage and restrictions.

# Roof Deck Protection

Helps shield the roof deck from moisture infiltration.

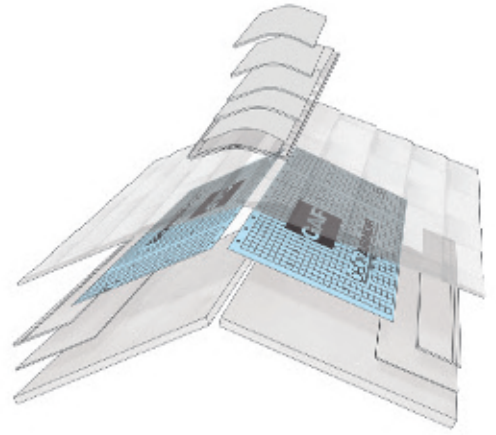

## Deck-Armor™



- Premium breathable synthetic underlayment for asphalt shingles and other roof systems
- Nom. 16 perms, high-traction surface helps resist tears
- 48" x 250' (1.22 m x 76.2 m); 10 Sq. (1,000 ft<sup>2</sup> [92.9 m<sup>2</sup>]) roll size - excludes laps

## Tiger Paw™



- Premium synthetic underlayment for asphalt shingles and other roof systems
- High-traction surface helps resist tears, and deck side coating provides moisture control
- 48" x 250' (1.22 m x 76.2 m); 10 Sq. (1,000 ft<sup>2</sup> [92.9 m<sup>2</sup>]) roll size - excludes laps

## FeltBuster®



- High-traction synthetic underlayment for asphalt shingles
- Value-priced, high-traction surface helps resist tearing
- 48" x 250' (1.22 m x 76.2 m); 10 Sq. (1,000 ft<sup>2</sup> [92.9 m<sup>2</sup>]) roll size - excludes laps

## Shingle-Mate™



- Fiberglass-reinforced underlayment for asphalt shingles
- Fiberglass reinforcement lays flat and helps prevent telegraphing through shingles
- 36" x 144' (.914 m x 43.89 m); 4 Sq. (432 ft<sup>2</sup> [40.13 m<sup>2</sup>]) roll size - excludes laps

### Specialty Underlayment

## VersaShield®







- Fiberglass-reinforced fire-resistant underlayment for asphalt shingles, metal, wood, and other roof systems
- Helps upgrade the UL Fire Rating of many roofing systems (always consult the UL Certification Directory) and helps resist dangerous flame spread
- 42" x 100' (1.07 m x 30.48 m); 3.5 Sq. (350 ft<sup>2</sup> [32.5 m<sup>2</sup>]) roll size - excludes laps

For the full collection visit [gaf.ca/RoofDeckProtection](http://gaf.ca/RoofDeckProtection)

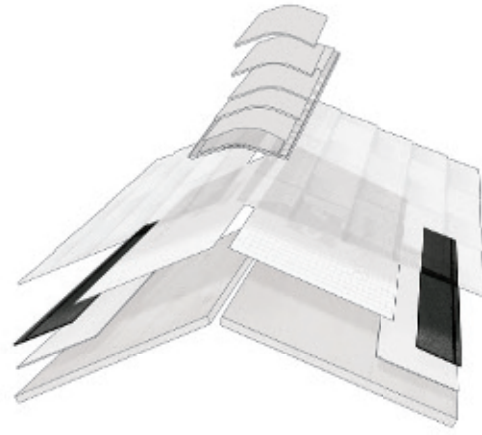
# Starter Strip Shingles

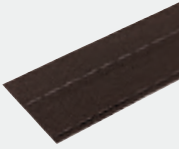
Help guard against shingle blow-offs at the eaves and rakes.

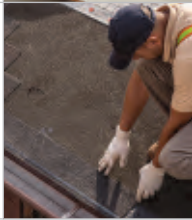

<p><b>WeatherBlocker™</b></p>		<ul style="list-style-type: none"> <li>▪ Premium starter strip shingles for all asphalt shingles</li> <li>▪ Extra-wide format, pre-perforated design, and factory-applied Dura Grip™ Adhesive</li> <li>▪ Full sheets measure 17" x 40" (432 mm x 1,016 mm) and cover 50 lin. ft. (15 lm) per bundle. Half sheets measure 8 ½" x 40" (216 mm x 1,016 mm) and cover 100 lin. ft. (30 lm) per bundle.</li> </ul>
<p><b>QuickStart®</b></p>		<ul style="list-style-type: none"> <li>▪ Peel and stick starter strip roll for most standard English and metric-sized asphalt shingles</li> <li>▪ Mineral surfacing with factory-applied Dura Grip™ Adhesive</li> <li>▪ 9" x 33' (228 mm x 10 m) roll size</li> </ul>
<p><b>Pro-Start®</b></p>		<ul style="list-style-type: none"> <li>▪ Starter strip shingles for most standard English and metric-sized asphalt shingles</li> <li>▪ Pre-perforated design with factory-applied Dura Grip™ Adhesive</li> <li>▪ Full sheets measure 13" x 38" (330 mm x 965 mm) and are split into half sheets measuring 6 ½" x 38" (165 x 965 mm) to cover 120.33 lin. ft. (36.69 lm) per bundle</li> </ul>
<p><b>StarterMatch®</b></p>		<ul style="list-style-type: none"> <li>▪ Complementary-colour starter strip shingles for Grand Sequoia® and Grand Canyon® Shingles</li> <li>▪ Used in conjunction with WeatherBlocker™</li> <li>▪ Full sheets measure 13 ¼" x 40" (337 mm x 1,016 mm) and cover 60 lin. ft. (18.3 lm) per bundle</li> </ul>

For the full collection visit [gaf.ca/StarterStrip](http://gaf.ca/StarterStrip)

<sup>1</sup> To qualify for this coverage, must be installed with GAF Lifetime Shingles and at least 3 qualifying GAF Accessories. See [gaf.ca/LRS](http://gaf.ca/LRS) for qualifying products and see *GAF Roofing System Limited Warranty* for complete coverage and restrictions.

# Cobra® Attic Ventilation

Helps reduce attic moisture and heat.\*

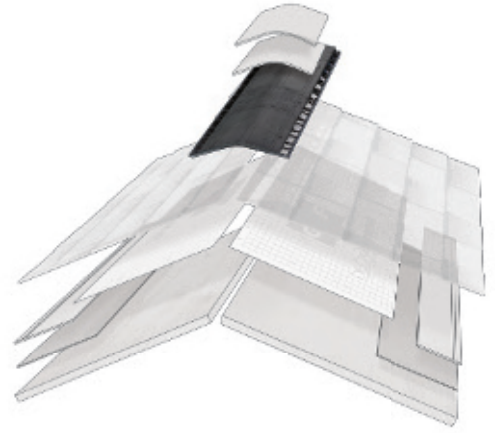

## Ridge & Hip Exhaust Ventilation

<p><b>Cobra® Exhaust Vent</b></p>		<ul style="list-style-type: none"> <li>▪ Mesh roll ridge vent for all climates</li> <li>▪ 10 1/2" (267 mm), 8" (203 mm), and 11 3/4" (298 mm) widths; 20' (6.1 m) and 50' (15.24 m) lengths</li> <li>▪ Includes 2 1/2" (64 mm) Smart Nails™ (Hand Nailable) or 1 3/4" (44 mm) Coil Nails (Nail Gunnable)</li> <li>▪ NFA: Hand Nailable - 16.9 sq. in./lin. ft. (35,772 mm<sup>2</sup> per lineal meter); Nail Gunnable - 14.1 sq. in./lin. ft. (29,845 mm<sup>2</sup> per lineal meter)</li> </ul>
<p><b>Cobra® SnowCountry® Advanced</b></p>		<ul style="list-style-type: none"> <li>▪ Premium plastic ridge vent for colder climates</li> <li>▪ Includes 3" (76 mm) ring shank nails, Snow Guard™ Filter and EasyTear® Sizing</li> <li>▪ 11 1/2" (292 mm) and 9" (229 mm) widths; 4' (1.2 m) length, 40 lin. ft. (12.2 lm) per box</li> <li>▪ NFA: 18 sq. in./lin. ft. (38,100 mm<sup>2</sup> per lineal meter)</li> </ul>
<p><b>Cobra® RidgeRunner®</b></p>		<ul style="list-style-type: none"> <li>▪ Plastic roll ridge vent for all climates</li> <li>▪ Includes 1 3/4" (44 mm) coil nails, Weather Fighter® Filter and EasyTear® Sizing</li> <li>▪ 11 1/2" (292 mm) width; 20' (6.1 m) length</li> <li>▪ NFA: 12.5 sq. in./lin. ft. (26,458 mm<sup>2</sup> per lineal meter)</li> </ul>
<p><b>Cobra® Hip Vent</b></p>		<ul style="list-style-type: none"> <li>▪ Plastic hip vent for all climates</li> <li>▪ Includes 1 3/4" (44 mm) coil nails and Dual Weather Fighter® Filter</li> <li>▪ 11 1/2" (292 mm) width; 4' (1.2 m) length, 40 lin. ft. (12.2 lm) per box</li> <li>▪ NFA: 9 sq. in./lin. ft. (19,050 mm<sup>2</sup> per lineal meter)</li> </ul>

## Intake Ventilation

<p><b>Cobra IntakePro®</b></p>		<ul style="list-style-type: none"> <li>▪ Tapered roll intake vent for all climates</li> <li>▪ Includes 1 3/4" (44 mm) coil nails and end cap fabric</li> <li>▪ 11" (279 mm) width; 20' (6.1 m) length</li> <li>▪ NFA: 9 sq. in./lin. ft. (19,050 mm<sup>2</sup> per lineal meter)</li> <li>1. See photo for product placement</li> </ul>
--------------------------------	--	--

For more details visit [gaf.ca/Cobra](http://gaf.ca/Cobra)

<sup>1</sup> To qualify for this coverage, must be installed with GAF Lifetime Shingles and at least 3 qualifying GAF Accessories. See [gaf.ca/LRS](http://gaf.ca/LRS) for qualifying products and see *GAF Roofing System Limited Warranty* for complete coverage and restrictions.

# Ridge Cap Shingles

The finishing touch that helps defend against leaks at the hips and ridges.

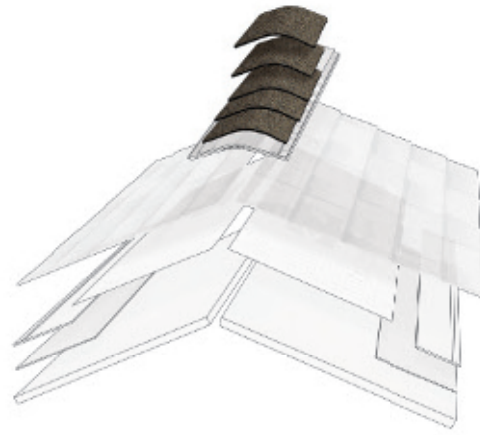







<p><b>TimberTex®</b></p>			<ul style="list-style-type: none"> <li>▪ Premium double-layer ridge cap shingles for use with Timberline® HDZ™, UHD, with: and GAF Designer Lifetime Shingles</li> <li>▪ Pre-perforated design and factory-applied Dura Grip™ Adhesive</li> <li>▪ 12" (305 mm) width, 8" (203 mm) exposure, covers 20 lin. ft. (6.1 lm) per bundle</li> <li>▪ Available in all areas of Canada</li> </ul>
<p><b>Seal-A-Ridge®</b></p>			<ul style="list-style-type: none"> <li>▪ Traditional look ridge cap shingles for use with Timberline® HDZ™ and UHD Shingles</li> <li>▪ Pre-perforated design with: and factory-applied Dura Grip™ Adhesive</li> <li>▪ 12" (305 mm) width, 6 2/3" (169 mm) exposure, covers 25 lin. ft. (7.6 lm) per bundle</li> <li>▪ Available in all of Canada except British Columbia</li> </ul>
<p><b>TimberCrest®</b></p>			<ul style="list-style-type: none"> <li>▪ Premium SBS-modified bullnose ridge cap shingles for use with Timberline® HDZ™, UHD, and GAF Designer Lifetime Shingles</li> <li>▪ Pre-folded/flexed design with: and factory-applied Dura Grip™ Adhesive</li> <li>▪ 10" (254 mm) and 8" (203 mm) widths, 8" (203 mm) exposure, covers 20 lin. ft. (6.1 lm) per box</li> <li>▪ Available in British Columbia</li> </ul>
<p><b>Ridglass®</b></p>			<ul style="list-style-type: none"> <li>▪ High-profile SBS-modified ridge cap shingles for use with Timberline® HDZ™ and UHD Shingles</li> <li>▪ Pre-folded design with: and factory-applied Dura Grip™ Adhesive</li> <li>▪ 10" (254 mm) and 8" (203 mm) widths, 8" (203 mm) exposure, covers 31 lin. ft. (9.4 lm) per box</li> <li>▪ Available in the British Columbia</li> </ul>
<p><b>Seal-A-Ridge® AS</b></p>			<ul style="list-style-type: none"> <li>▪ UL Class 4 impact resistance, pre-perforated design with: and factory-applied Dura Grip™ Adhesive</li> <li>▪ For use with GAF ArmorShield® Series Shingles.</li> <li>▪ 12" (305 mm) width, 5" (127 mm) exposure, covers 25 lin. ft. (7.6 lm) per bundle</li> </ul>

For more details visit [gaf.ca/RidgeCaps](http://gaf.ca/RidgeCaps)

NOTE: These products are not available in all areas. Visit [www.gaf.ca/ridgecapavailability](http://www.gaf.ca/ridgecapavailability) for more information.

Ventilation products that help minimize heat and moisture in attics, while helping to resist mold and mildew.



<p><b>Power attic vents - roof mount</b></p>	<p>1</p> 	<ul style="list-style-type: none"> <li>▪ Exhaust large amounts of heat and moisture from the attic</li> <li>▪ High-efficiency PSC motors</li> <li>▪ Thermostat control included on all models. Optional combo humidistat/thermostat control available on select models</li> <li>▪ Available in popular colours to complement most finished roofs</li> <li>▪ Also available in gable mount</li> </ul>
<p><b>Solar-powered vents</b></p>	<p>2</p> 	<ul style="list-style-type: none"> <li>▪ Helps reduce electricity costs associated with operating a fully electric powered vent<sup>1</sup></li> <li>▪ Available in both solar-powered and unique dual-powered models</li> <li>▪ Solar-powered models run off the sun's power, while dual-powered models switch automatically between sun and house power</li> <li>▪ Thermostat or combo humidistat/thermostat control available on select models</li> </ul>
<p><b>Roof louvers</b></p>	<p>3</p> 	<ul style="list-style-type: none"> <li>▪ Allow heat and moisture to escape the attic on roofs with limited ridge</li> <li>▪ Styles: Slant-back, square-top, dome</li> <li>▪ Construction: Aluminum, galvanized, plastic, aluminum granule-coated</li> <li>▪ Net Free Area per Vent: Options from 37 – 144 sq. in. (23,871 – 92,903 mm<sup>2</sup>)</li> </ul>
<p><b>Aluminum ridge vent</b></p>		<ul style="list-style-type: none"> <li>▪ Allows heat and moisture to escape the attic</li> <li>▪ Construction: Aluminum with built-in baffle</li> <li>▪ Net Free Area: 21.5 Sq. in. per lin. ft. (45,508 mm<sup>2</sup> per lineal meter)</li> </ul>
<p><b>Wind turbines</b></p>		<ul style="list-style-type: none"> <li>▪ Use wind power to pull heat and moisture from the attic</li> <li>▪ Sizes: 12" (305 mm) &amp; 14" (356 mm)</li> <li>▪ Construction: Aluminum internally braced, galvanized internally, or externally braced</li> </ul>
<p><b>Soffit/undereave intake vents</b></p>		<ul style="list-style-type: none"> <li>▪ Allow cooler dry air to enter the attic</li> <li>▪ Styles: Continuous, oval, rectangular, EmberShield<sup>®</sup> closeable</li> <li>▪ Net Free Area per Vent: Options from 22 – 68 Sq. in. (14,194–43,871 mm<sup>2</sup>)</li> </ul>
<p><b>Other vents and accessories</b></p>		<p><b>Also available:</b> Master Flow<sup>®</sup> Gable Wall Louvers, Goose Neck Vents, Vent Caps, Chimney Caps, Zinc Strips, Whole House Fans, and Foundation Vents</p>

For the full collection visit [gaf.ca/MasterFlow](http://gaf.ca/MasterFlow)





The one and only solution for replacing old asbestos siding.

**Siding** - contains NO asbestos<sup>1</sup>

<p><b>Purity™ Shingle</b></p>		<p>Textured surface with straight, wavy, or thatched edge</p>	<ul style="list-style-type: none"> <li>▪ Size: 12" x 24" (305 mm x 609 mm)</li> <li>▪ Exposure: Straight and Wavy 11" (279 mm), Thatched 10 ½" (267 mm)</li> </ul>
<p><b>Profile Shingle</b></p>		<p>Striated surface with straight edge</p>	<ul style="list-style-type: none"> <li>▪ Size: 9" x 32" (227 mm x 813 mm)</li> <li>▪ Exposure: 8" (203 mm)</li> <li>▪ Size: 12" x 24" (305 mm x 609 mm)</li> <li>▪ Exposure: 11" (279 mm)</li> <li>▪ Size: 14 5/8" x 32" (371 mm x 813 mm)</li> <li>▪ Exposure: 13 5/8" (346 mm)</li> </ul>
<p><b>Emphasis™ Shingle</b></p>		<p>Extra-thick wood grain look surface with thatched edge</p>	<ul style="list-style-type: none"> <li>▪ Size: 14 5/8" x 25 5/32" (371 mm x 639 mm)</li> <li>▪ Exposure: 13" (330 mm)</li> </ul>

**Accessories**

<p><b>Siding Backer Strips</b></p>		<p>Help protect the vertical seams between each piece of siding against weather infiltration</p>	<ul style="list-style-type: none"> <li>▪ 9" (227 mm)</li> <li>▪ 12" (305 mm)</li> <li>▪ 14" (357 mm)</li> </ul>
<p><b>Hot-dipped Galvanized Siding Nails</b></p>		<p>Help provide maximum holding power and an excellent finished look</p>	<ul style="list-style-type: none"> <li>▪ White, ring shank nails</li> <li>▪ 1 ¾" (44 mm)</li> </ul>
<p><b>Pre-primed Individual Corners</b></p>		<p>Complete the outside corners of your WeatherSide™ Siding job</p>	<ul style="list-style-type: none"> <li>▪ 9" (227 mm)</li> <li>▪ 12" (305 mm)</li> <li>▪ 14" (357 mm)</li> <li>▪ Emphasis™ corners</li> </ul>

Visit [gaf.ca/WeatherSide](http://gaf.ca/WeatherSide)

<sup>1</sup>We recommend that any removal and disposal of asbestos-containing products be done by a professionally trained asbestos removal contractor.

Help reduce heat drive into conditioned/living spaces, and ventilated options exhaust excess moisture to reduce the risk of condensation in the roofing system.<sup>1</sup>



**Ventilated Roof Insulation Panels**

<p><b>ThermaCal<sup>®</sup> 1</b></p>		<ul style="list-style-type: none"> <li>▪ For asphalt shingle and metal roof systems</li> <li>▪ Nominal 4' x 8' (1.21 m x 2.44 m) panels with single layer of sheathing (7/16" OSB [11.1 mm] standard); other options available</li> <li>▪ Includes air space and tongue-and-groove polyiso foam to reduce heat loss through panel joints</li> <li>▪ Pre-spaced sheathing eliminates the need for H-clips and allows for sheathing expansion</li> </ul>
<p><b>ThermaCal<sup>®</sup> 2</b></p>		<ul style="list-style-type: none"> <li>▪ For slate, tile, and maximum loading roof systems</li> <li>▪ Nominal 4' x 8' (1.21 m x 2.44 m) panels with two layers of sheathing (7/16" OSB [11.1 mm] standard); other options available</li> <li>▪ Includes air space and tongue-and-groove polyiso foam to reduce heat loss through panel joints</li> <li>▪ Pre-spaced sheathing eliminates the need for H-clips and allows for sheathing expansion</li> </ul>

**Non-Ventilated Roof Insulation Panels**

<p><b>ThermaCal<sup>®</sup></b></p>		<ul style="list-style-type: none"> <li>▪ For metal roof systems</li> <li>▪ Nominal 4' x 8' (1.21 m x 2.44 m) panels with single layer of sheathing (7/16" OSB [11.1 mm] standard); other options available</li> <li>▪ Tongue-and-groove polyiso foam to reduce heat loss through panel joints</li> <li>▪ Pre-spaced sheathing eliminates the need for H-clips and allows for sheathing expansion</li> </ul>
-------------------------------------	--	---

**Exterior Wall Insulation Panels**

<p><b>ThermaCal<sup>®</sup> Wall</b></p>		<ul style="list-style-type: none"> <li>▪ Nominal 4' x 8' (1.21 m x 2.44 m) panels with one layer of sheathing (7/16" OSB [11.1 mm] standard); other options available</li> <li>▪ Includes tongue-and-groove polyiso foam (8' [2.44 m] sides only) to reduce heat loss through panel joints</li> <li>▪ Pre-spaced sheathing (8' [2.44 m] sides) allows for precision fit and sheathing expansion</li> </ul>
--	--	--

**Nail Base Insulation Panel Fasteners**

<p><b>ThermaCal<sup>®</sup> Light-duty drill point fasteners</b></p>		<ul style="list-style-type: none"> <li>▪ Designed for attaching ThermaCal<sup>®</sup> Insulation Panels to steel roof decks/substrates</li> <li>▪ Manufactured with case-hardened and tempered carbon steel</li> </ul>
<p><b>ThermaCal<sup>®</sup> Thread point fasteners</b></p>		<ul style="list-style-type: none"> <li>▪ Designed for attaching ThermaCal<sup>®</sup> Insulation Panels to wood roof decks/substrates</li> <li>▪ Manufactured with case-hardened and tempered carbon steel</li> </ul>

For the full collection visit [gaf.ca/ThermaCal](http://gaf.ca/ThermaCal)

**GAF** **LIBERTY™**  
SBS Self-Adhering Roofing System

Self-adhering low-slope roofing systems. Perfect for porches, garages, car ports, and sunrooms!

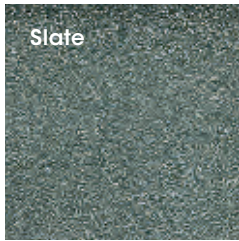

# Before you bid on only half this roof



## Talk to GAF first

The partners you count on to support your roofing business are ready to champion your growth in whatever direction you want to go. GAF offers a full line of low-slope and steep-slope roofing systems. Technical support. Expert training. And excellent warranties and guarantees backed by North America's largest roofing manufacturer. If you're ready to grow, talk to GAF, first. [gaf.ca/TalktoGAF](https://gaf.ca/TalktoGAF)