



# SCS2000 SilPruf™

## Silicone Sealant & Adhesive

### Product Description

GE SCS2000 is a one-component, high-strength, neutral cure silicone sealant & adhesive for use in structural glazing and on a wide variety of materials in new or remedial weatherproofing applications. SCS2000 sealant is supplied as a paste and upon cure, produces a durable, formed-in-place silicone rubber joint sealant.

### Key Features and Typical Benefits

#### Performance

- **Silicone Durability**—Cured silicone rubber exhibits excellent long term resistance to natural weathering including: extreme temperatures, ultraviolet radiation, rain and snow, with negligible change in elasticity.
- **Strength Properties**—SilPruf silicone's combination of high tensile strength, high tear strength and the capacity to absorb high deformations (elongation) make this product an outstanding candidate for protective glazing designs and seismic applications
- **Low VOC**—Significantly lower than the U.S. Green Building Council's Leadership in Energy and Environmental Design (L.E.E.D.) program's requirements. Neutral cure byproduct with low odor.
- **±50% Movement Capacity**—Can accommodate 50% movement in both extension and compression and has excellent recovery after cycling.

#### Application

- **Adhesion**—Primerless adhesion to many substrates and finishes. May be considered a candidate for use with numerous construction-related materials, including: glass, polycarbonate, vinyl, numerous plastics, treated and untreated wood, fluoropolymer and powder coated paints, conversion-coated and anodized aluminum, EIFS, brick, terra-cotta, ceramic and porcelain materials, concrete and natural stones. Some finishes or substrates may require a primer.

- **Thermal Stability (cured state)**—Once cured, the material remains elastic over a range of -55°F (-48°C) to 300°F (149°C) and up to 400°F (204°C) under intermittent short-term exposure.
- **Stable Consistency (uncured state)**—Supplied as a lightweight paste, the consistency of which remains relatively unchanged over a wide temperature range. The paste is able to be easily gunned and tooled under hot and cold conditions.
- **Extended Work Life**—Designed to allow the user sufficient time for placement and tooling.
- **Low Sag or Slump**—Useful for application to horizontal, vertical or overhead surfaces.

#### Product Compatibility

- Compatible with the following GE silicone coatings: SilShield™, Optic™, Enduris™, and Elemax™.
- Compatible with the following silicone products: IGS3713, IGS3723, IGS3760, RGS7700, SCS2350, SCS2700, SCS2800, SCS2811, SCS2900, SSG4000, SSG4000AC, SSG4000E, SSG4400, SSG4600, SSG4650, SSG4800J, SWS, US1100, UST2200.

### Potential Applications

SCS2000 sealant is recommended for the following applications:

#### Weatherproofing

- Between dissimilar or similar materials in either new or remedial glazing and sealing applications
- Around window perimeters and punched openings

#### Structural Glazing

- With sufficient project review



### Potential Applications—(continued)

#### Protective Glazing

- Successfully tested in protective glazing designs, may be considered a candidate for such applications

#### Adhesive

- Applied in panel stiffener applications
- Useful for adhering US1100 and UST2200 UltraSpan pre-cured silicone weatherstrip product line

### Packaging

SCS2000 sealant is available in the following configurations:

- 10.1 fl oz (299 ml) plastic caulking cartridges
- 20 fl oz (591.5 ml) foil sausage packs
- 2 gallon (7.6 L) plastic pails
- 5 gallon (18.9 L) plastic pails

### Colors

SCS2000 sealant is available in 13 standard colors, and can be custom colored.



SCS2002  
White



SCS2003  
Black

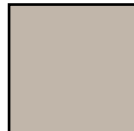

SCS2004  
Limestone

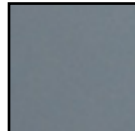

SCS2007  
Medium Grey

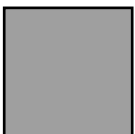

SCS2008  
Light Grey

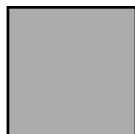

SCS2009  
Aluminum Grey



SCS2010  
Dark Grey



SCS2020  
Precast White



SCS2097  
Bronze



SCS2040  
Earth Tone

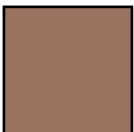

SCS2041  
Red Brick



SCS2046  
Champagne

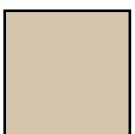

SCS2100.0148  
Sandy Beige

### Typical Physical Properties

Typical property values of SCS2000 as supplied and cured are set forth in the tables below. Typical product data values should not be used as specifications. Assistance with specifications is available by contacting MPM at +1 (877) 943-7325.

#### Typical Properties – Supplied

Property	Value <sup>(1)</sup>	Test Method
Consistency	Paste	
Polymer	100% silicone	
VOC	20 g/l	WPSTM C1454
Work Life (tooling time)	30-40 minutes	
Tack Free Time	3-4 hours (@ 72°F, 50% RH)	ASTM C679
Sag/Slump	0.1" max.	ASTM D2202

#### Typical Properties – Cured

Property	Value <sup>(1)</sup>	Test Method
Hardness, Durometer (Type A Indentor)	24	ASTM D2240
Ultimate Tensile Strength	341 psi (2.35 MPa)	ASTM D412
Ultimate Elongation	715%	ASTM D412,
Tensile at 50% Elongation	47.0 psi (0.32 MPa)	ASTM C1184
Tensile at 100% Elongation	73.2 psi (0.50 MPa)	ASTM C1184
Ultimate Tensile Strength	140.5 psi (0.97 MPa)	ASTM C1135
Ultimate Elongation	353%	ASTM C1135
Tear Strength; die B	76.8 ppi	ASTM D624
Shear Strength (@ 1/4" thickness)	121.4 psi (0.84 MPa)	ASTM C961
Peel Strength (average) (21-day cure @ 75°F (21°C) 50% RH)	56.6 pli	ASTM C794
Joint Movement Capability	±50%	ASTM C719
Service Temperature Range (after cure)	-55°F to +250°F (-48°C to 121°C)	
Weathering and U.V. Resistance	Excellent	GE 20 yr. study
Cure Time (1/4" or 6 mm deep section) @ 75°F (24°C) 50% RH	3-4 days	
Full Cure (most common bead sizes)	10-14 days	

(1) Typical properties are average data and are not to be used as or to develop specifications.

### Installation

Sealants may not adhere or maintain long-term adhesion to substrates if the surface is not prepared and cleaned properly before sealant application. Using proper materials and following prescribed surface preparation and cleaning procedures is vital for sealant adhesion. IN ALL CASES IT IS IMPORTANT TO CONFIRM THE ACCEPTIBILITY OF EACH SEALANT-SUBSTRATE COMBINATION WITH A LAB OR SITE ADHESION TEST PRIOR TO PROCEEDING WITH PROJECT INSTALLATION. MPM can provide lab and field adhesion testing information and suggestions to user upon request.



### Installation—continued

#### Surface Preparation

##### **Porous Materials (concrete, masonry, brick, stone, etc.)**

- Joints must be clean, dry and sound prior to application of the sealant. All contaminants, impurities, or other adhesion inhibitors (such as moisture/frost, oils, concrete form release agents, old sealants, asphalt and other surface treatments, etc.) must be removed from the surfaces to which the sealant is intended to adhere.
- Clean where necessary by wire brush, mechanical abrading, grinding, sanding, saw cutting, blast cleaning (sand or water), or a combination of these methods to provide a stable clean surface for sealant application.
- Remove dust and other remaining loose particles with a soft bristle brush or by using an oil-free air blow.
- Polished stone surfaces and smooth sawn edges can be cleaned using a solvent dampened rag (allow sufficient time for solvent to evaporate prior to application of the sealant). When handling solvents, refer to manufacturer's MSDS for information on handling, safety and personal protective equipment.
- Cleaning of surfaces should be done within 1 to 2 hours of when the sealant is to be applied.
- Since porous materials can absorb and retain moisture, it is important to confirm that substrates are dry prior to application of the sealant.

##### **Non-Porous Materials (glass, metals, plastics, ceramics, etc.)**

- Clean by using a two-rag wipe technique ??wet one rag with solvent and wipe the surface with it, then use the second rag to wipe the wet solvent from the surface BEFORE it evaporates (allowing the solvent to dry on the surface without immediately wiping with a second cloth can negate the cleaning procedure because the contaminants may simply be re-deposited as the solvent dries). In all cases where used, solvents should be wiped dry with a clean, white cloth or other lint-free wiping materials. Change the cleaning rags frequently, as they become dirty. It is easier to see the dirt accumulating on the rag if white rags are used. Do not dip used cleaning rags into the cleaning solvent as this can contaminate the solvent (cleaning with contaminated solvent can result in sealant adhesion issues). Always use clean solvent-resistant containers for solvent use and storage.
- When cleaning deep, narrow structural glazing cavities, wrap the cleaning cloth around a clean, narrow-blade putty knife. This permits force to be applied to the cleaned surface.
- Isopropyl Alcohol (IPA) is a commonly-used solvent and has proven useful for most non-porous substrates encountered in architectural construction applications. Xylene and Toluene have also been found useful on many substrates. When handling solvents, refer to manufacturer's MSDS for information on handling, safety and personal protective equipment.

- Architectural coatings, paints and plastics should be cleaned with a solvent approved by the manufacturer of the product or which does not harm or alter the finish.
- Cleaning of surfaces should be done within 1 to 2 hours of when the sealant is to be applied.
- Difficult or nearly impossible to see on a joint substrate, frost is likely to develop on substrates when temperatures drop near the freezing point. Since frost and moisture will interfere with proper sealant adhesion, it is important to confirm that substrates are dry prior to application of the sealant.

##### **Exterior Insulation and Finish Systems (EIFS)**

- The use of an appropriate silicone primer is required on all EIFS substrates. Consult MPM Technical Services for sealant-primer-substrate recommendations.
- Confirm with the EIFS supplier which finish the sealant should be applied to (i.e., base coat or base coat with EIFS primer).
- All EIFS surfaces must be clean, dry and sound and in an acceptable condition to receive sealant. Confirm with the EIFS supplier or project architect or consultant, what joint conditions are considered acceptable for sealant installation to proceed. If unacceptable conditions are found, cease installation of sealant until corrections are made.
- To clean EIFS, lightly abrade the joint surfaces using a synthetic brush or pad and then remove dust and other remaining loose particles with a soft bristle brush or using an oil-free air blow.
- Cleaning of surfaces should be done within 1 to 2 hours of when the sealant is to be applied.
- Since EIFS materials can absorb and retain moisture, it is important to confirm that the EIFS materials are dry prior to application of the sealant.

#### Priming

SCS2000 sealant attains primerless adhesion to many commonly encountered construction materials. However, some materials with variable surface characteristics may require the use of a primer to help obtain durable long-term adhesion. Prior to use, trial applications should be made to check adhesion to the specific materials to be used on the project. See the GE sealants primer datasheets for product specific information on use and priming instructions. PRIMER APPLICATION IS NOT A SUBSTITUTE FOR SURFACE PREPARATION. Consult MPM Technical Services for sealant-primer-substrate recommendations.

**CAUTION:** Primers may contain solvents. When handling solvents, refer to manufacturer's MSDS for information on handling, safety and personal protective equipment.



## Installation—continued

### Masking

The use of masking tape is recommended where appropriate to ensure a neat job and to protect adjoining surfaces from over-application of sealant. Masking tape can prevent contact of sealant with adjoining surfaces that otherwise would be permanently marred or damaged by such contact or by cleaning methods required to remove sealant systems. When tooling, use care not to spread the sealant over the face of the substrates adjacent to the joint or masking as the silicone can be extremely difficult to remove on rough or porous substrates. Do not allow masking tape to touch clean surfaces to which the silicone sealant is to adhere (adhesive on masking tape can interfere with adhesion of silicone). Masking tape should be removed immediately after tooling the sealant and before the sealant begins to skin over (tooling time).

### Sealant Application – WEATHERSEALING

- Apply sealant in a continuous operation, horizontally in one direction and vertically from the bottom to the top of the joint opening, applying a positive pressure adequate to properly fill and seal the joint width.
- Tool or strike the sealant with a concave tool applying light pressure to spread the material against the back-up material and the joint surfaces to ensure a void-free application.
- In glazing applications, tool the sealant at the sill so that precipitation and cleaning solutions will not pool.
- Excess sealant should be cleaned from glass, metal and plastic surfaces while still uncured. On porous surfaces the excess sealant should be allowed to progress through the initial cure or set-up. It should then be removed by abrasion or other mechanical means.
- Due to the smooth consistency of SCS2000 sealant, tooling agents such as water, soap, or detergent solutions are not necessary or recommended. Dry tooling is recommended.
- Sealant is best applied when the temperature is above 40°F (4°C) as frost or moisture are less likely to be present on the surfaces to be sealed. However, SCS2000 sealant can be applied in colder temperatures; refer to the MPM technical bulletin “Cold Weather Sealing Guidelines” for additional information.
- Application of SCS2000 sealant is not recommended to be applied to substrates when surface temperatures are surfaces above 50°C (122°F).
- The cure rate of this product is dependent upon temperature and the availability of atmospheric moisture. Under Standard Conditions (relative humidity of 50 ± 5% at an air temperature of 73.4 ± 2°F [23 of ± 1°C]) this material can attain a cured thickness of 2-3 mm per 24 hours (assuming ample access to atmospheric moisture). As temperature decreases, the cure rate slows down (and vice versa). Low moisture environments will also reduce the

cure rate. Near-confined spaces which limit the overall access to atmospheric moisture will cure only from that surface which has access to the atmosphere. Colder temperatures can significantly increase cure times and can open the possibility of sealant irregularities if joint movement occurs while sealant is not fully cured. The following reference provides additional information on Movement-During-Cure of sealant joints: ASTM C1193 - Standard Guide for Use of Joint Sealants; section 12.5.

### Sealant Application – STRUCTURAL GLAZING

- Apply the sealant by pushing the bead ahead of the nozzle and making sure that the entire cavity is filled. Tooling should be done neatly, forcing the sealant into contact with the sides of the joint, thus helping to eliminate any internal voids and assuring good substrate contact.
- SCS2000 sealant should not be applied in totally confined spaces since the sealant requires exposure to air to cure properly and develop typical properties. In a typical SSG cavity, cure depths up to 3/4" (19 mm) from an air interface will generally cure satisfactorily and reach maximum properties within several days. Cure depths > 3/4" (19 mm) may take significantly longer time to cure and when applied in a single application may not cure satisfactorily. Consult MPM technical services for additional information on depth of cure for this product.

### Method of Application

SCS2000 sealant is easily dispensed directly from cartridges and foil sausage packs using standard caulking guns or from 2 gallon pails using standard bulk caulking gun equipment. The sealant may also be dispensed from 55 gallon drums with pumping equipment.

### Joint Designs and Dimensions— Weathersealing Applications

**Joint Movement**—The dimensions of joints in typical construction applications change daily as a result of solar heat gain and building sway, and throughout the year due to seasonal changes. The movement in a sealant bead installed on the sun-side of a building or during the hottest portion of the day will be almost entirely in extension during the cold season or cycle; while the movement of a bead installed during the coldest condition will be almost entirely in compression during the hotter season or cycle. In addition to these above movements, the designer should consider the effect of construction tolerances in his/her project to minimize the occurrence of over-sized or under-sized joints during construction. All moving (dynamic) joints must be designed so as not to allow three-sided adhesion of the sealant to occur (reference ASTM C1193). Three-sided adhesion hinders the ability of the sealant to extend and compress freely as desired and can lead to early joint failure.



### Installation—continued

#### Joint Designs and Dimensions— Weathersealing Applications—continued

**Joint Width**—When using SCS2000 sealant, the designed joint width must be at least twice the total anticipated joint movement. For example, if the total anticipated movement in an expansion joint in which SCS2000 sealant is to be installed is 1/4" (6 mm), the designed joint width must be at least 1/2" (12 mm). The designer may want to consider additional width to accommodate construction tolerances (reference ASTM C1472). Large panels or lites should allow a minimum width of 1/4" (6 mm) for the sealant bead, mostly to allow for a proper installation (very small/narrow beads become difficult to install and can accommodate less movement). Glazing of plastic or larger-sized metal panels may require larger than usual joint widths due to the greater movement potential (higher coefficients of thermal expansion). Consult with MPM Technical Services for recommendations on large or unusual applications.

**Butt Joints**—A thin installation of silicone sealant can better accommodate more movement than a deep installation, as the deeper bead will result in additional stress being imposed on both the sealant and the bonding surfaces during joint movement.

Figure 1 illustrates the general guidelines for installation of SCS2000 sealant into a typical butt joint configuration of widths up to 2" (5 cm).

- 1.) The recommended sealant profile is an hourglass shape with the depth of the sealant over the crown of the backer rod to be no thinner than 1/8" (3 mm) and no thicker than 3/8" (10 mm), and
- 2.) A minimum of 1/4" (6 mm) of adhesive bonding contact must be made to all surfaces to which the sealant is intended to adhere.

When used in joints exceeding 2" (5 cm) in width:

- 3.) The recommended sealant profile is an hourglass shape with the depth of the sealant over the crown of the backer rod to be no thinner than 1/4" (6 mm) and no thicker than 3/8" (10 mm), and
- 4.) A minimum of 3/8" (10 mm) of adhesive bonding contact must be made to all surfaces to which the sealant is intended to adhere.

Figure 1

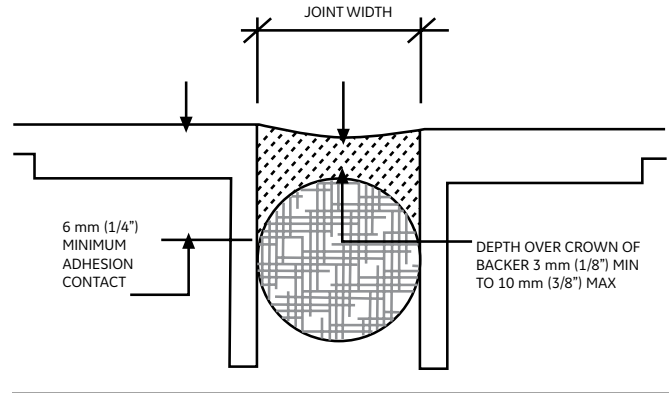

#### Joint Backer Materials

Backer materials, typically backer rod, provide the following benefits to aid in the correct application of SCS2000 sealant.

- 1.) To control and provide the desired sealant depth.
- 2.) Create a formed joint cavity that allows for the desired hourglass sealant shape.
- 3.) Provide a firm backup which helps attain full wetting of the substrates when the sealant is tooled.
- 4.) Act as a bond breaker to eliminate adhesion on the backside of a joint (three-sided adhesion).

Non-gassing polyethylene, polyolefin or polyurethane foam rod is the recommended back-up material for use with SCS2000 sealant. If the joint is too shallow to allow foam rod, use a polyethylene tape (as a bond breaker to eliminate three-sided adhesion). On EIFS and porous substrate applications, a closed cell backer rod is recommended (open cell backer materials absorb and hold water which can affect long-term sealant adhesion on these materials). Backer rod should be 25-50% greater (confirm with manufacturer of backer rod as to type selected) than the width of the joint, thereby providing continuous pressure against the joint walls, and expanding and contracting with the joint movement without pushing the sealant out of the joint during the compression cycle or falling away during the extension cycle. Rubber backup materials may stain the sealant and are not recommended, unless tested and verified for compatibility.

#### Joint Designs and Dimensions— Structural Glazing Applications

- Silicone contact width and thickness (see Figure 2) will vary by project with the design wind load and glass size.
- **Contact Width** can be calculated using the following formula:  
[Design Wind Load (PSF) x Longest Short Span of Glass or Panel (Ft.)] divided by 480.



### Installation—continued

#### Joint Designs and Dimensions— Structural Glazing Applications—continued

- A minimum sealant **thickness** of 1/4" (6 mm) between substrates is required to accommodate thermal expansion and contraction (see Figure 3) of most systems and should be used in order to assure that sealant can be injected into the structural cavity obtaining full contact with both the glass and metal surfaces while remaining free of air voids. Greater joint thickness may be required to accommodate movement in some larger-sized SSG systems. MPM can be contacted to assist in determination of proper joint thickness to accommodate expected movement in structurally glazed applications.

#### Soliciting Manufacturers Suggestions

Required materials for submission:

- Architectural and shop drawings for review and comment.
- Design wind load requirement(s) for project.
- Glass or panel sizes.
- Production samples of metal, glass, gaskets, spacers and setting blocks with type and manufacturer identified.
- Specification and/or identification of paint or finish to which SCS2000 sealant is intended to adhere (i.e., 215-R1 anodized or if paint; manufacturer, finish system and ID#).

*Recommendations & information provided after review:*

- Determination as to whether the submitted joint dimensions meet the minimum design criteria necessary for the use of SCS2000 sealant.
- Short-term adhesion data using (typically) ASTM C794, C1635, ISO 8340, ISO 8339, ISO 10591 and/or ASTM C1135 test method. Other test methods may be requested for a nominal charge.
- Short-term compatibility test results on gaskets, spacers and setting blocks and other accessories per ASTM C1087 or MPM plant standard test method for compatibility.
- Information regarding suggested primers, when required.

#### Momentive Performance Materials will not:

- Design sealant joints.
- Provide comments on the structural integrity of overall framing system(s).

The design professional has final responsibility for the determination of structural sealant joint dimensions based on project conditions, design wind load(s), glass or panel sizes, anticipated thermal, seismic or other movement of the system.

The ASTM C1401 Standard Guide for Structural Sealant Glazing provides a thorough overview of design topics and information for use in SSG systems.

Figure 2

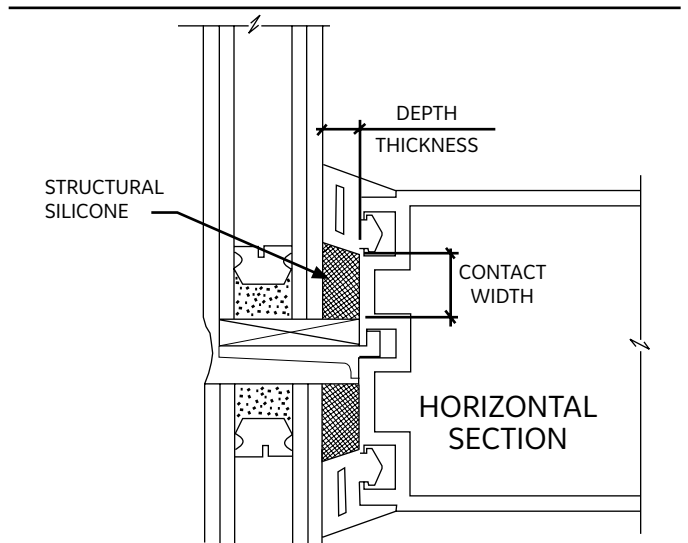
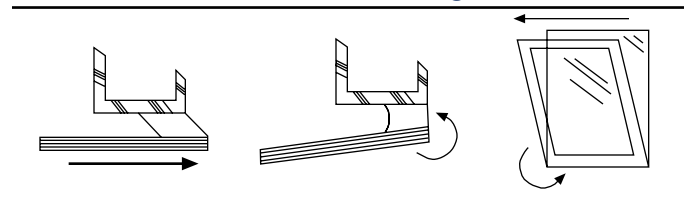

Figure 3: Movement from thermal expansion and contraction and/or glass rotation



### Applicable Standards

SCS2000 sealant meets or exceeds the requirements of the following specifications:

#### American Society for Testing & Materials International

- ASTM C920 Standard Specification for Elastomeric Joint Sealants; Type S, Grade NS, Class 50, Use A, G, M, O, NT
- ASTM C1184 Standard Specification for Structural Silicone Sealants; Type S, Use G & O

#### U.S. Federal Specifications:

(widely referenced but cancelled Sept. 1996)

- TT-S-001543A Sealing Compound: Silicone Rubber Base (for Caulking, Sealing & Glazing in Buildings and Other Structures)
- TT-S-00230C Sealing Compound: Elastomeric Type, Single Component (for Caulking, Sealing & Glazing in Buildings and Other Structures)

#### Canadian General Standards Board (currently inactive)

CGSB-19.13-M87 Sealing Compound, One-Component, Elastomeric, Chemical Curing

SCS2000 sealant carries SWR Institute validation @ ±50% movement.



### Technical Services

Additional technical information and literature is available from MPM Laboratory facilities and application engineering are available upon request from MPM. Any technical advice furnished by MPM or any representative of MPM concerning any use or application of any sealant is believed to be reliable but MPM makes no warranty, expressed or implied, of suitability for use in any application for which such advice is furnished.

### Limitations

Customers must evaluate Momentive Performance Materials (MPM) products and make their own determination as to fitness of use in their particular applications.

#### SCS2000 sealant is not recommended:

- For use underwater or in other applications where the product will be in continuous contact with water.
- For use in food contact applications.
- When painting of the cured sealant is desired (unless appropriate specialized paint products are used).
- For structural adhesion on bare metals or surfaces subject to corrosion (i.e., mill aluminum, bare steel, etc.).
- When using colors other than black for structural glazing applications, contact Momentive Technical Services prior to use.

#### SCS2000 sealant should not be applied or used:

- In structural glazing applications unless Momentive Performance Materials (MPM) has reviewed shop drawings for applicability and has performed adhesion and compatibility tests on project substrates, spacer materials and all accompanying accessories. Review and testing is done on a project-by-project basis. No blanket approval is given by MPM for structural glazing applications. Structural glazing industry guidelines (ASTM C1401) suggest that drawings and details are to be reviewed by all parties involved in the manufacture of an SSG system and for each building project.
- Under exceedingly hot or cold conditions (see Sealant Application section for additional information).
- On wet, damp, frozen or contaminated surfaces.
- On excessively basic or acidic substrates.
- In exceedingly large structural cavities (see Sealant Application section for additional information).

### Precautions

- This material requires atmospheric moisture to cure from paste to rubber and may not attain its listed final cured rubber properties when used in designs or applications where the silicone is encapsulated and lacks access to atmospheric moisture.
- When sealing against natural stones, MPM recommends that stain testing be performed prior to use to ascertain the visual acceptability of the sealant-stone combination. MPM recommends evaluation of SCS9000 sealant when sealing to natural stones.
- Some materials that bleed plasticizers or oils can cause a discoloration on the surface of sealants. When sealing to or over items such as rubberized gaskets, bituminous-based materials, butyl or oil-based products, oily woods, tapes, etc., MPM recommends that compatibility testing be performed prior to use to confirm the suitability of the use of these materials when in contact with each other.
- Silicone materials are hydrophobic in nature and if inadvertently over-applied onto adjacent joint surfaces (even if removed immediately), can create a waterproofing effect on some sub- strate types when the substrate is wet. See section on Masking.

### Suggested References

In addition to the guidelines provided on this datasheet, MPM recommends that designers and users of SCS2000 sealant familiarize themselves with the latest editions of following industry guidelines and best practices:

- 1.) ASTM C1193 Standard Guide for Use of Joint Sealants.
- 2.) ASTM C1481 Standard Guide for Use of Joint Sealants with Exterior Insulation & Finish Systems (EIFS).
- 3.) ASTM C1472 Standard Guide for Calculating Movement and Other Effects When Establishing Sealant Joint Width.
- 4.) ASTM C1401 Standard Guide for Structural Sealant Glazing 5.) SWR Institute's Applying Liquid Sealants Applicator Training Program.



### Patent Status

Nothing contained herein shall be construed to imply the nonexistence of any relevant patents or to constitute the permission, inducement or recommendation to practice any invention covered by any patent, without authority from the owner of the patent.

### Product Safety, Handling and Storage

Customers considering the use of this product should review the latest Material Safety Data Sheet and label for product safety information, handling instructions, personal protective equipment if necessary, and any special storage conditions required. Material Safety Data Sheets are available at [www.ge.com/silicones](http://www.ge.com/silicones) or, upon request, from any MPM representative. Use of other materials in conjunction with MPM sealants products (for example, primers) may require additional precautions. Please review and follow the safety information provided by the manufacturer of such other materials.

### Customer Service Centers

<b>Americas</b>	+1 800 295 2392  +1 704 805 6946  Email: <a href="mailto:commercial.services@momentive.com">commercial.services@momentive.com</a>
<b>Europe, Middle East, Africa, and India</b>	+00 800 4321 1000  +40 212 044229  Email: <a href="mailto:4information.eu@momentive.com">4information.eu@momentive.com</a>
<b>Asia Pacific</b>	<b>Japan</b> 0120 975 400 +81 276 20 6182  <b>China</b> +800 820 0202 +86 21 3860 4892  <b>All APAC</b> +60 3 9206 1543  Email: <a href="mailto:4information.ap@momentive.com">4information.ap@momentive.com</a>
<b>Visit us at <a href="http://www.ge.com/silicones">www.ge.com/silicones</a></b>	

THE MATERIALS, PRODUCTS AND SERVICES OF MOMENTIVE PERFORMANCE MATERIALS INC. AND ITS SUBSIDIARIES AND AFFILIATES (COLLECTIVELY "SUPPLIER"), ARE SOLD SUBJECT TO SUPPLIER'S STANDARD CONDITIONS OF SALE, WHICH ARE INCLUDED IN THE APPLICABLE DISTRIBUTOR OR OTHER SALES AGREEMENT, PRINTED ON THE BACK OF ORDER ACKNOWLEDGMENTS AND INVOICES, AND AVAILABLE UPON REQUEST. ALTHOUGH ANY INFORMATION, RECOMMENDATIONS, OR ADVICE CONTAINED HEREIN IS GIVEN IN GOOD FAITH, SUPPLIER MAKES NO WARRANTY OR GUARANTEE, EXPRESS OR IMPLIED, (i) THAT THE RESULTS DESCRIBED HEREIN WILL BE OBTAINED UNDER END-USE CONDITIONS, OR (ii) AS TO THE EFFECTIVENESS OR SAFETY OF ANY DESIGN INCORPORATING ITS PRODUCTS, MATERIALS, SERVICES, RECOMMENDATIONS OR ADVICE. EXCEPT AS PROVIDED IN SUPPLIER'S STANDARD CONDITIONS OF SALE, SUPPLIER AND ITS REPRESENTATIVES SHALL IN NO EVENT BE RESPONSIBLE FOR ANY LOSS RESULTING FROM ANY USE OF ITS MATERIALS, PRODUCTS OR SERVICES DESCRIBE HEREIN. Each user bears full responsibility for making its own determination as to the suitability of Supplier's materials, services, recommendations, or advice for its own particular use. Each user must identify and perform all tests and analyses necessary to assure that its finished parts incorporating Supplier's products, materials, or services will be safe and suitable for use under end-use conditions. Nothing in this or any other document, nor any oral recommendation or advice, shall be deemed to alter, vary, supersede, or waive any provision of Supplier's standard Conditions of Sale or this Disclaimer, unless any such modification is specifically agreed to in a writing signed by Supplier. No statement contained herein concerning a possible or suggested use of any material, product, service or design is intended, or should be construed, to grant any license under any patent or other intellectual property right of Supplier covering such use or design, or as a recommendation for the use of such material, product, service or design in the infringement of any patent or other intellectual property right.

Before purchasing or using any Momentive products, please visit [www.siliconeforbuilding.com/legaldisclaimer](http://www.siliconeforbuilding.com/legaldisclaimer) to view our full product and sales disclaimer.

GE is a registered trademark of General Electric Company and is used under license by Momentive Performance Materials Inc.

The use of the "™" symbol designates registered or unregistered trademarks of Momentive Performance Materials Inc. or its affiliated companies.

Copyright 2011-2021 Momentive Performance Materials Inc. All rights reserved.

[siliconeforbuilding.com](http://siliconeforbuilding.com)