



GP Georgia-Pacific

**DensGlass**<sup>®</sup>  
Sheathing

# TECHNICAL GUIDE

## SHEATHING

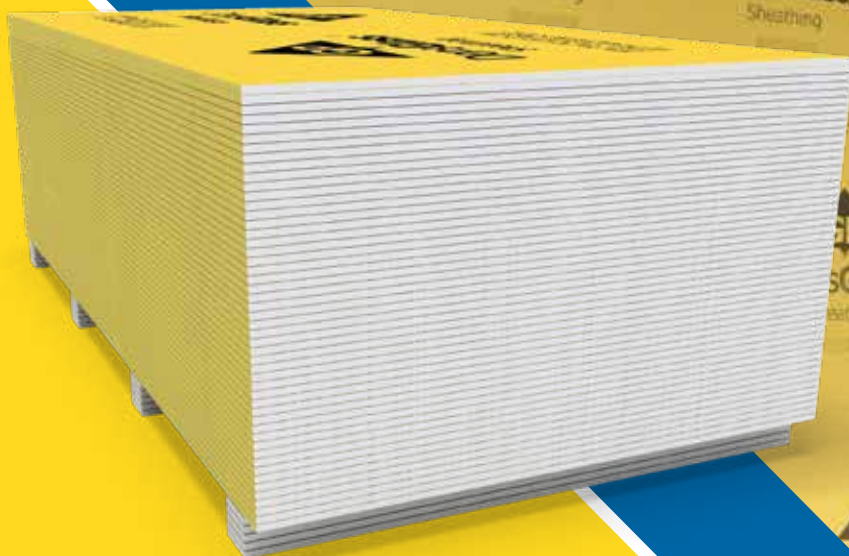

## Product Overview

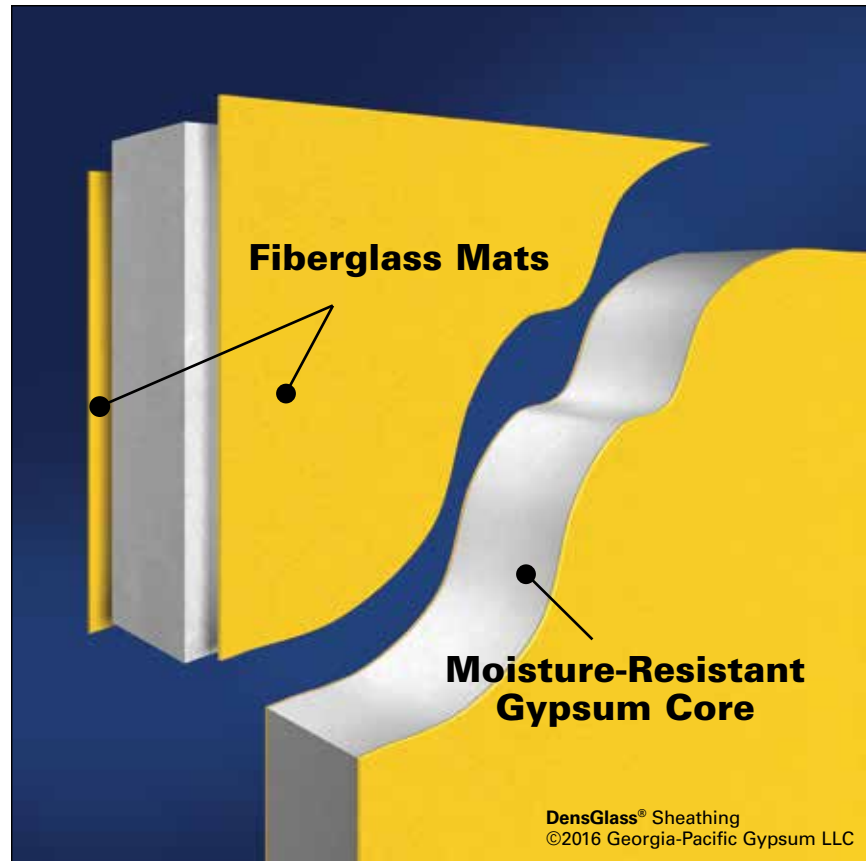

### Table of Contents

|  |    |
|--|----|
| Product Overview . . . . .   | 2  |
| Sustainability . . . . .   | 4  |
| Physical Properties . . . . .                                      | 5  |
| Installation Instructions . . . . .                                | 5  |
| Wall Applications . . . . .  | 6  |
| Fastening and Framing . . . . .                                    | 8  |
| Negative Uniform<br>Wind Load . . . . .                            | 8  |
| Soffit Applications, Fastening,<br>Framing and Finishing . . . . . | 9  |
| Water- and Air-Resistive<br>Barriers . . . . .                     | 10 |
| Protection of Penetrations . . . . .                               | 10 |
| Fire-Rated Assemblies . . . . .                                    | 11 |
| Delivery, Handling<br>and Storage . . . . .                        | 14 |
| Recommendations and<br>Limitations for Use . . . . .               | 14 |
| Commonly Used Metric<br>Conversions . . . . .                      | 15 |

DensGlass® Sheathing, with its recognizable GOLD color, has fiberglass mats for superior mold and moisture resistance compared to paper-faced sheathings.

- Fiberglass mats eliminate a potential food source for mold and may reduce remediation and scheduling delays associated with paper-faced drywall.
- Replaces traditional paper-faced sheathing.
- Backed with a limited warranty against delamination and deterioration for up to 12 months of exposure to normal weather conditions.\*

\*For complete warranty details, visit [www.buildgp.com/warranties](http://www.buildgp.com/warranties).

When tested, as manufactured, in accordance with ASTM D3273, DensGlass Sheathing has scored a 10, the highest level of performance for mold resistance under the ASTM D3273 test method.

The score of 10, in the ASTM D3273 test, indicates no mold growth in a 4-week controlled laboratory test. The mold resistance of any building product when used in actual job site conditions may not produce the same results as were achieved in the controlled, laboratory setting. No material can be considered mold proof. When properly used with good design, handling and construction practices, Dens® Brand gypsum products provide increased mold resistance compared to standard paper-faced wallboard. For additional information, go to [www.buildgp.com/safetyinfo](http://www.buildgp.com/safetyinfo).

### Available Sizes/Dimensions

DensGlass Sheathing is available in 1/2" (12.7 mm) thickness and DensGlass® Fireguard® Sheathing is available in 5/8" (15.9 mm) thickness. DensGlass Sheathing is manufactured in a 4' (1219 mm) width and 8' (2438 mm), 9' (2743 mm) and 10' (3048 mm) lengths. Other lengths are available upon request.

DensGlass® Sheathing is a preferred substrate under brick, stone, stucco, siding and Exterior Insulation and Finishing Systems (EIFS) because of its exemplary track record. DensGlass Sheathing should be specified for any project where flexibility and easy sheathing installation are paramount without the headaches and expense of delamination, deterioration, sagging and warping. Look for the distinctive GOLD color to ensure you're using genuine DensGlass Sheathing.

### **Mold Resistance**

In independent testing, DensGlass Sheathing, with its fiberglass mat design, has achieved a score of 10, the highest level of performance for mold resistance under ASTM D3273. For additional information concerning mold resistance, go to [www.buildgp.com/safetyinfo](http://www.buildgp.com/safetyinfo).

### **Strength**

Fiberglass mats penetrate into the panel to make an integrated unit that offers superb strength; outstanding resistance to delamination, deterioration, warping and job site damage; and an excellent bonding surface for EIFS and air barrier systems. The flexural strength of DensGlass Sheathing is approximately the same in both directions. This means DensGlass Sheathing can be installed either vertically or horizontally without sacrificing wall strength between studs. DensGlass panels also protect and help stabilize structural framing.

### **Stability**

DensGlass Sheathing is extremely resistant to rippling, buckling and sagging, even under humid conditions—which makes it particularly suitable for soffits. In actual tests, DensGlass panels exceeded ASTM C1396 standards for humidified deflection by a factor of five times over the standard for paper-faced gypsum sheathing.

### **Fire Resistance**

DensGlass Sheathing is noncombustible as described and tested in accordance with ASTM E136 or CAN/ULC S114. 5/8" (15.9 mm) DensGlass® Fireguard® Sheathing is included in a variety of UL and ULC listings and other designs in the GA-600 Fire Resistance Design Manual.

### **Superior Weather Protection**

DensGlass Sheathing integrates a water-resistant, treated core with a fiberglass mat face and back to provide superb protection from the elements.

A water-resistive barrier is not required over DensGlass Sheathing to provide for the protection of the gypsum sheathing during installation. DensGlass Sheathing is the ideal substrate for a wide variety of air and water-resistive barriers including building wraps, fluid applied coatings, self-adhering membranes and spray foam applications. See page 10 for details.

### **Easy to Handle**

DensGlass Sheathing is lightweight and easy to handle. It can be cut and fastened with standard drywall tools and fasteners. The product is much easier to work with than cement board, fiber cement sheathing or magnesium oxide sheathing which tend to be heavy and brittle.

### **Outstanding Warranty**

DensGlass Sheathing is covered by a 12-month limited warranty against delamination and deterioration for exposure to normal weather conditions, a five-year limited warranty against manufacturing defects and a 12-year limited warranty against manufacturing defects when used as a substrate for architecturally specified EIFS. For a copy of the limited warranty, visit our website at [www.buildgp.com/warranties](http://www.buildgp.com/warranties).

### **Standards and Code Compliance**

DensGlass Sheathing is manufactured to meet ASTM C1177. Application standards where applicable are in accordance with Gypsum Association Publication GA-253 for gypsum sheathing or ASTM C1280.

Evaluated by:

- ICC ES: [www.icc-es.org/reports/index.cfm?search=search](http://www.icc-es.org/reports/index.cfm?search=search)
- Florida Product Approval: [www.floridabuilding.org](http://www.floridabuilding.org)

*The data relating to fire- and sound-tested assemblies is based on the characteristics, properties and performance of materials and systems obtained under controlled test conditions as set forth under the appropriate ASTM standard, such as E 119 (fire), E 90 (sound) or E 72 (structural).*

*\*For use in select assemblies.*

### **Georgia-Pacific Gypsum and Sustainability**

Georgia-Pacific Gypsum's definition of sustainability is meeting the needs of society today without jeopardizing our ability to do so in the future. We are committed to using resources efficiently to provide innovative products and solutions that meet the needs of customers and society, while operating in a manner that is environmentally and socially responsible, and economically sound.

We continue to focus on:

- Improving energy efficiency at our manufacturing plants
- Seeking out opportunities to reduce water use, and to reuse water more efficiently
- Finding cost effective ways to further reduce air emissions
- Recovering and reusing materials that otherwise would end up in landfills.

Green building codes, standards, and programs are establishing themselves across the country. They promote the use of products that contribute to the performance of the building, along with minimizing environmental and human health impacts over the life of the building or home. Because we embrace product performance and operate in an environmentally, socially, and economically sound manner, owners and architects can feel good about the structures they build using our products.

Many of our products contribute to LEED® and other green building codes, standards, or program credits or requirements. Please refer to [www.gpgypsum.com](http://www.gpgypsum.com) for recycled content, regional materials, and low emitting materials information and use our on-line LEED calculator to calculate contribution for a specific credit. For general information on sustainability, visit [www.buildgp.com/sustainability](http://www.buildgp.com/sustainability).

## Physical Properties

| Product Comparison   | 1/2" (12.7 mm)<br>DensGlass®<br>Sheathing             | 5/8" (15.9 mm)<br>DensGlass®<br>Fireguard®            |
|--|---|---|
| Width, nominal <sup>5</sup>  | 4' (1219 mm)<br>± 3/32" (2.4 mm)                      | 4' (1219 mm)<br>± 3/32" (2.4 mm)                      |
| Length, standard <sup>5</sup>  | 8', 9', 10'<br>(2438, 2743, 3048 mm)<br>± 1/4" (6 mm) | 8', 9', 10'<br>(2438, 2743, 3048 mm)<br>± 1/4" (6 mm) |
| Weight <sup>9</sup> nominal, lbs./sq. ft. (Kg/m <sup>2</sup> )                                     | 1.9 (9)   | 2.5 (12)  |
| Bending radius (lengthwise)  | 6' (1829 mm) <sup>6</sup>                             | 8' (2438 mm) <sup>6</sup>                             |
| Racking strength, <sup>7</sup> lbs./ft. (dry) (N/m)<br>(Ultimate – not design value)               | >540<br>(7878)  | >654<br>(9544)  |
| Flexural strength, <sup>2</sup> parallel, lbf. (N)<br>(4' weak direction)                          | ≥80 <sup>6</sup> (356)                                | ≥100 (445)  |
| Compressive strength   | min. 500 psi<br>(3445 kPa)                            | min. 500 psi<br>(3445 kPa)                            |
| Humidified deflection <sup>2,5</sup>   | <2/8" (6 mm)  | <1/8" (3 mm)  |
| Permeance, <sup>3</sup> perms (ng/Pa·s·m <sup>2</sup> )  | >23 [1300]  | >17 [970]   |
| R Value <sup>4</sup> , ft <sup>2</sup> ·°F·hr/BTU (m <sup>2</sup> ·K/W)                            | .56 (0.099)   | .67 (0.118)   |
| Combustibility <sup>8</sup>  | Noncombustible  | Noncombustible  |
| Linear expansion with moisture<br>change in/in/%RH (mm/mm %RH) <sup>10</sup>                       | 6.25 x 10 <sup>-6</sup>                               | 6.25 x 10 <sup>-6</sup>                               |
| Surface burning characteristics<br>(per ASTM E84 or CAN/ULC-S102):<br>flame spread/smoke developed | 0/0   | 0/0   |
| Coefficient of thermal expansion<br>in/in/°F (mm/mm/°C) <sup>11</sup>                              | 8.5 x 10 <sup>-6</sup><br>(15.3 x 10 <sup>-6</sup> )  | 8.5 x 10 <sup>-6</sup><br>(15.3 x 10 <sup>-6</sup> )  |

<sup>1</sup> Specified values per ASTM C1396

<sup>2</sup> Tested in accordance with ASTM C473

<sup>3</sup> Tested in accordance with ASTM E96 (dry cup method)

<sup>4</sup> Tested in accordance with ASTM C518 (heat flow meter)

<sup>5</sup> Specified values per ASTM C1177

<sup>6</sup> Double fasteners on ends as needed

<sup>7</sup> Tested in accordance with ASTM E72

<sup>8</sup> As defined and tested in accordance with ASTM E136 or CAN/ULC S114

<sup>9</sup> Approximate weight for design and shipping purposes. Actual weight may vary based on manufacturing location and other factors.

<sup>10</sup> As stated by Gypsum Association GA-235

<sup>11</sup> Tested in accordance with ASTM E228-85

## Installation Instructions

- DensGlass® Sheathing must be installed in accordance with the instructions in this brochure, Gypsum Association document GA-253 and ASTM C1280. DensGlass Sheathing can be attached parallel or perpendicular to wood or metal framing. Use appropriate board orientation for specific fire assemblies and shear wall applications within this document, other reference documents or as required by designing authority. The framing width shall not be less than 1-1/2" (38 mm) wide for wood framing and 1-1/4" (32 mm) for steel framing. Framing members shall not vary more than 1/8" (3 mm) from the plane of the faces of adjacent framing.
- Fasteners should be driven flush with the panel surface (not countersunk) and into the framing system. Locate fasteners at least 3/8" (9 mm) from the ends and edges of the sheathing. Nails or screws, as listed in the fastener chart, may be used to attach DensGlass Sheathing to framing. When a pneumatic fastening system into metal is used to attach DensGlass Sheathing, consult with manufacturer for application specifications and shear resistance data. DensGlass Sheathing is not to be used as a base for nailing or other fastening.
- Install DensGlass Sheathing with joints staggered. DensGlass Sheathing shall be properly flashed at openings and preferably located so that no joint will align with an edge of the opening. Ends and edges of the sheathing should fit tightly. DensGlass Sheathing panels shall not be less than 7" (178 mm) from the finish grade in fully weather- and water-protected siding systems, and not less than 12" (305 mm) from the ground for properly drained and ventilated crawl spaces. Consult with the design authority for control joint recommendations.

## Wall Applications

### Installing Cladding over DensGlass® Sheathing

Most conventional exterior sidings and wall coverings—including vinyl, composition, metal, stone, brick, wood—may be applied over DensGlass Sheathing.

- |                                |                       |                        |
|--------------------------------|-----------------------|------------------------|
| A. DensGlass Sheathing         | G. Brick Masonry      | L. Fiber Cement Siding |
| B. Insulation                  | H. Flashing and Weeps | M. Metal Siding        |
| C. Framing                     | I. Wood Siding        |                        |
| D. Water-Resistive/Air Barrier | J. Plywood Siding     |                        |
| E. Masonry Tie                 | K. Vinyl Siding       |                        |
| F. 2" (50 mm) Max. Air Space   |                       |                        |

**Important: Illustrations not intended for design or specification purposes.**

#### Brick Cavity Wall

Masonry or stone veneer can be applied over DensGlass Sheathing just as it would be over any other type of sheathing. Attach the masonry ties securely through the panels and into the steel or wood framing. Space the ties as required by masonry courses. Apply water-resistive/air barrier and continuous insulation as required by building code or design authority.\*

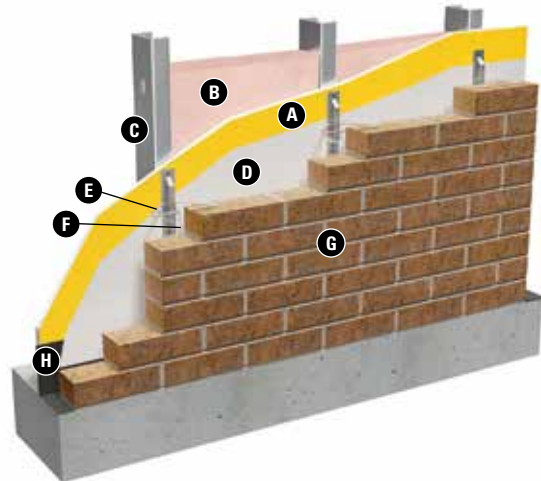

#### Vinyl, Metal, Wood, Fiber Cement Siding

DensGlass Sheathing can be used in applications such as under wood or plywood panel siding and other horizontal siding applications. All siding must be attached through the DensGlass Sheathing and into the steel or wood framing. Apply water-resistive/air barrier as required by building code or design authority.\*

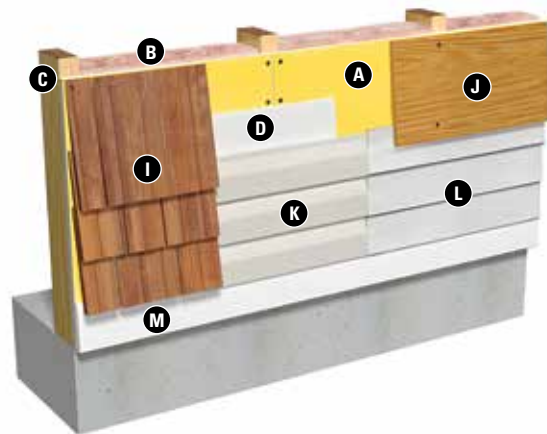

\*For a sheathing, water-resistive barrier and air barrier, that eliminates the need for building wrap or fluid applied membranes, see the DensElement™ Barrier System at [DensElement.com](http://DensElement.com)

## Wall Applications *continued*

- A. DensGlass® Sheathing
- B. Insulation
- C. Framing
- D. Paper-Backed Metal Lath
- E. Conventional Stucco System
- F. Minimum 1/4" (6 mm) Gap
- G. Flashing and Weeps

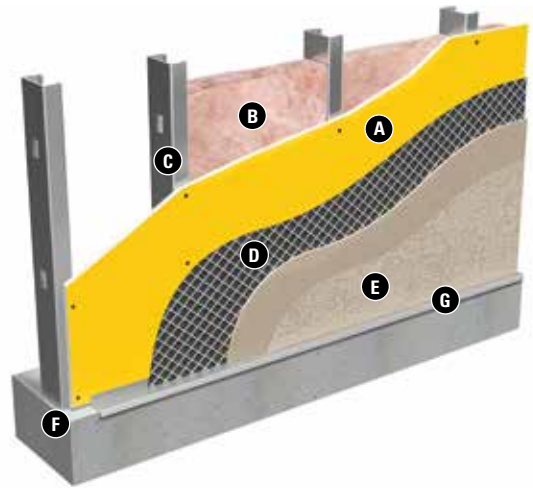

### Conventional Stucco

Stucco systems may be applied over DensGlass Sheathing using paper-backed metal lath or two layers of building paper and metal lath. Metal lath must be mechanically attached through the DensGlass Sheathing into the steel or wood framing. Install stucco system in accordance with the manufacturer's instructions and local building code requirements. For a sheathing, with an integrated water-resistive barrier and air barrier, that eliminates the need for building wrap or fluid applied membranes, see the DensElement™ Barrier System at DensElement.com.

### Exterior Insulation and Finish Systems (EIFS)

DensGlass Sheathing is an ideal substrate for adhesive or mechanical application of expanded polystyrene (EPS) or extruded polystyrene insulation in EIFS applications and is recommended for all climate zones.

DensGlass Sheathing is a preferred gypsum substrate for EIFS by EIMA (the EIFS industry members association). DensGlass Sheathing panels are surface treated with our exclusive GOLD color. This coating, developed especially for DensGlass Sheathing, has several important advantages for EIFS applications:

- Eliminates the need for sealer/primer with EIFS air and water resistive barrier coatings.
- Strengthens the bond between panel and surfacing insulation product.
- Makes the panel more resistant to surface water.
- 12-year limited warranty against manufacturing defects when used in an architecturally specified EIFS application (see [buildgp.com/warranties](http://buildgp.com/warranties) for complete warranty information).
- Maximum framing spacing 16" (406 mm) o.c. for 1/2" (12.7 mm) and 24" (610 mm) o.c. for 5/8" (15.9 mm) DensGlass® Fireguard® Sheathing.

- A. DensGlass Sheathing
- B. Water Resistive/Air Barrier
- C. Polystyrene Insulation
- D. Reinforcing Mesh Embedded in Base Coat
- E. Finish Coat
- F. Mesh Tape
- G. Coating to bed tape to DensGlass Sheathing

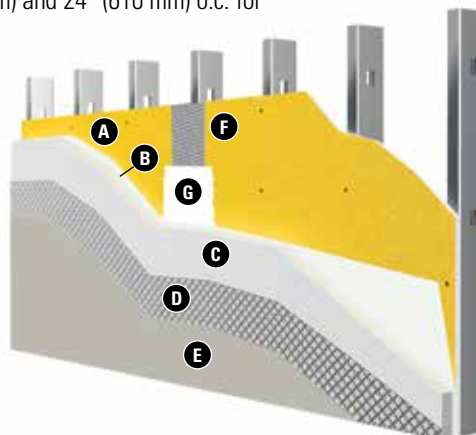





### High Velocity Hurricane Zone (HVHZ)

The ability to withstand the destructive winds and the impact of various objects during a hurricane in a coastal area is key to the survival of any exterior cladding system. DensGlass Sheathing from Georgia-Pacific Gypsum helps BASF, Sto Corp, Dryvit, and Parex-Lahabra, Inc. systems pass the strict Miami-Dade County and Florida Building Code requirements for High Velocity Hurricane Zones (HVHZ). The systems were tested independently to determine the performance against specific criteria for impact resistance, air and water infiltration resistance and wind load resistance. For more information, please visit Miami Dade HVHZ: [www.miamidade.gov/building/pc-search\\_app.asp](http://www.miamidade.gov/building/pc-search_app.asp) or contact the system manufacturer.

## Fastening and Framing

| Thickness      | Framing Spacing                    | Panel Orientation                      | Fastener Spacing – Wood Framing <sup>4</sup>    | Fastener Spacing – Metal Framing <sup>4</sup> |
|----------------|------------------------------------|--|---|---|
| 1/2" (12.7 mm) | 24" (610 mm) o.c. max <sup>3</sup> | Parallel <sup>3</sup> or Perpendicular | 8" (203 mm) o.c. field <sup>2</sup> & perimeter | 8" (203 mm) o.c. along framing                |
| 5/8" (15.9 mm) | 24" (610 mm) o.c. max <sup>3</sup> | Parallel <sup>3</sup> or Perpendicular | 8" (203 mm) o.c. field <sup>2</sup> & perimeter | 8" (203 mm) o.c. along framing                |

1. Only for mechanically attached claddings. When specified behind EIFS, maximum framing spacing for 1/2" (12.7 mm) DensGlass® Sheathing is 16" (406 mm) o.c.
2. Fastener spacing around the perimeter of the wall and along intermediate vertical framing members. To meet the racking shear strength listed in the physical properties table, fastener spacing is 4" (102 mm) o.c. around the perimeter of each panel and 8" (203 mm) o.c. along vertical framing members.
3. For racking strength resistance, apply panel edges parallel with framing spaced a maximum of 16" (406 mm) o.c. for both 1/2" (12.7 mm) and 5/8" (15.9 mm) DensGlass Sheathing.
4. Fire-rated assemblies may require additional fasteners, see specific assembly details.

| Fastener*   | Length                         |   | Description   | Application  |
|---|--------------------------------|---|---|--|
|   | 1/2" (12.7 mm) Thick Sheathing | 5/8" (15.9 mm) Thick Sheathing              |   |  |
|    | 1" (25 mm)                     | 1-1/4" (32 mm)                              | Bugle head fine thread, corrosion-resistant drill point drywall screw | DensGlass Sheathing to heavy-gauge metal framing (18 gauge or thicker)   |
|    | 1" (25 mm)                     | 1-1/4" (32 mm)                              | Bugle head fine thread, corrosion-resistant sharp point drywall screw | DensGlass Sheathing to light-gauge metal framing furring (20-25 gauge)   |
|    | 1-1/4" (32 mm)                 | 1-5/8" (41 mm)                              | Bugle head, rust-resistant, coarse thread sharp point screw           | DensGlass Sheathing to wood framing                                      |
|    | 1-1/4" (32 mm)                 | 1-1/4" (32 mm) metal<br>1-5/8" (41 mm) wood | Wafer head, corrosion-resistant screws, drill or sharp point          | DensGlass Sheathing to heavy-gauge or light-gauge, metal or wood framing |
|  | 1-1/2" (38 mm)                 | 1-3/4" (45 mm)                              | 11-gauge, galvanized nail   | DensGlass Sheathing to wood framing                                      |

\*For screws, meet or exceed ASTM C1002 or C954. Contact fastener manufacturer for correct amount of corrosion resistance.

## Negative Uniform Wind Load

### 5/8" (15.9 mm) DensGlass® Fireguard® Sheathing Horizontally Applied

| Stud Spacing, In./O.C. (mm) | Screws, In./O.C. (mm) | Ultimate load, PSF* (kPa) |
|-----------------------------|-----------------------|---------------------------|
| 16 (406)                    | 8 (203)               | 127 (6.08)                |
| 16 (406)                    | 6 (152)               | 142 (6.80)                |
| 16 (406)                    | 4 (102)               | 192 (9.19)                |
| 12 (305)                    | 8 (203)               | 157 (7.51)                |
| 12 (305)                    | 6 (152)               | 204 (9.77)                |
| 12 (305)                    | 4 (102)               | 270 (12.93)               |
| 8 (203)                     | 8 (203)               | 208 (9.96)                |
| 8 (203)                     | 6 (152)               | 354 (16.95)               |
| 8 (203)                     | 4 (102)               | 410 (19.63)               |

NOTE: Apply DensGlass Sheathing to appropriately engineered framing system. Tested applied to 6" (152 mm) x 1-5/8" (41 mm) 18-gauge (43 mils) steel studs using #6 1-1/4" (32 mm) bugle head screws. Other stud sizes may be suitable.

Source: Tested in accordance with ASTM E330 by Hurricane Test Laboratory. For a copy of report #G488-1001-07, contact Georgia-Pacific Gypsum Technical Hotline at 1-800-225-6119.

\*Apply appropriate safety factor from the design method used to calculate design load.

### 1/2" (12.7 mm) DensGlass Sheathing and 5/8" (15.9 mm) DensGlass Fireguard Sheathing Vertically or Horizontally Applied

| Thickness Inches (mm) | Board Orientation | Stud Spacing in. o.c. (mm) | Ultimate Load PSF* (kPa) |
|-----------------------|-------------------|----------------------------|--------------------------|
| 1/2" (12.7)           | Vertical          | 16 (406)                   | 65 (3.11)                |
| 1/2" (12.7)           | Horizontal        | 16 (406)                   | 70 (3.35)                |
| 5/8" (15.9)           | Vertical          | 24 (610)                   | 68 (3.26)                |
| 5/8" (15.9)           | Horizontal        | 24 (610)                   | 85 (4.07)                |
| 5/8" (15.9)           | Vertical          | 16 (406)                   | 92 (4.40)                |

Source: TPI Report #89-047; wind load per ASTM E330 (bugle head screws 8" (203 mm) o.c.).

\*Apply appropriate safety factor from the design method used to calculate design load.



## Soffit Applications, Fastening, Framing and Finishing

Method #1

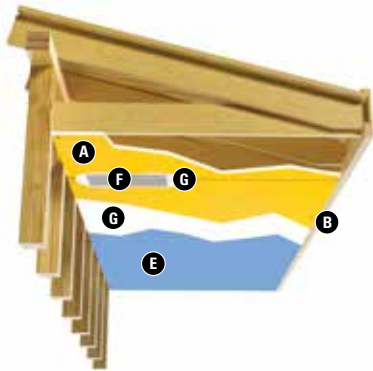

Method #2

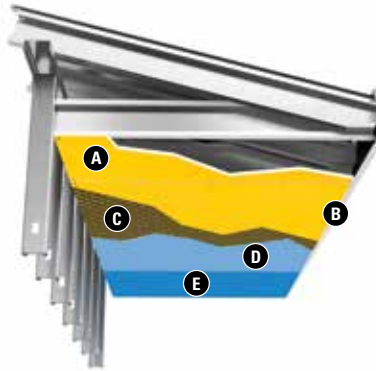

Method #3

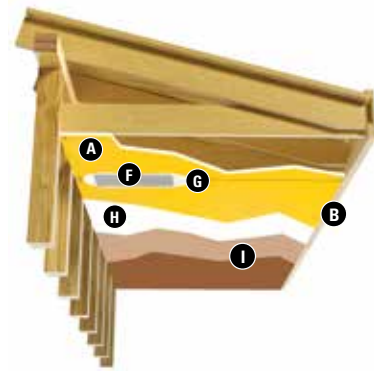

- A. DensGlass® Sheathing
- B. Drip Edge
- C. Reinforcing Mesh/Base Coat
- D. Base Coat
- E. Finish Coat
- F. 2" (51 mm) Fiberglass Mesh Tape
- G. Gypsum Setting Type Compound\*
- H. Bonding Agent to Entire DensGlass Sheathing Surface
- I. 2 Coat Thin Stucco System not to exceed 1/4" to 3/8" Total Thickness

*\*Sandable setting compounds are not recommended.*

| Thickness      | Framing Spacing       | Orientation                    | Screw Spacing                  |
|----------------|-----------------------|--------------------------------|--------------------------------|
| 1/2" (12.7 mm) | 16" (406 mm) o.c. max | Parallel or Perpendicular      | 8" (203 mm) o.c. along framing |
| 1/2" (12.7 mm) | 24" (610 mm) o.c. max | Perpendicular 24" o.c. framing | 8" (203 mm) o.c. along framing |
| 5/8" (15.9 mm) | 24" (610 mm) o.c. max | Parallel or Perpendicular      | 8" (203 mm) o.c. along framing |

### Method #1

Embed 2" (51 mm) wide fiberglass mesh tape in 90 minute gypsum setting type joint compound over all joints. Upon setting, apply a skim coat of setting compound over the panels to achieve a uniform, smooth finish over the entire area. Prime with exterior-grade primer and finish with two coats of exterior-grade paint.

### Method #2

Apply a synthetic-type Direct Applied Finish System in accordance with the coating manufacturer's recommendation.

#### Special conditions for both methods:

- Control joints are recommended a maximum of 30 feet (9144 mm) or closer as specified by the design authority.
- The roof must be dried in or protection from the elements must be provided prior to installing DensGlass Sheathing in horizontal applications to prevent moisture from ponding or settling on top of the sheathing panel or within the finished soffit.
- Sandable setting compounds are not acceptable for use over DensGlass Sheathing in exterior soffit applications.

### Method #3

- Finish joints as described in method #1.
- Apply a bonding agent to entire DensGlass Sheathing surface.
- Apply a 2-coat thin stucco system directly to the DensGlass Sheathing (2-coat system not to exceed 1/4" to 3/8" total thickness).

**Important: Illustrations not intended for design or specification purposes.**

---

## Water- and Air-Resistive Barriers

Evolving codes, standards and programs are requiring the use of water and air resistive barriers. In most cases, these barriers are applied over the exterior sheathing. DensGlass® Sheathing has been widely accepted as a preferred substrate for all recognized types of water and air resistive barriers.

- Self-adhered sheet materials
- Fluid applied membranes
- Spray polyurethane foam (medium density closed cell)
- Mechanically attached flexible sheet (includes #15 asphalt felt and synthetic wraps)
- Boardstock air barrier – rigid foam core

For a list of air barrier materials, accessories and components, see the Air Barrier Association of America (ABAA) website ([www.airbarrier.org](http://www.airbarrier.org)).

Where joint protection is required or desired, two methods may be used: **Method 1**) Apply minimum 3/8" (9 mm) bead of sealant to joints and trowel to provide a layer approximately 2" (51 mm) wide by 1/16" (2 mm) thick spanning the joint. Use backer rod for openings larger than 1/8" (3 mm). **Method 2**) Apply glass mesh joint tape to all joints, overlapping at intersections by the width of the tape. Apply approximately 3/8" (9 mm) bead of caulk along the joint. Embed the caulk into the entire surface of the tape with a trowel. Use backer rod for openings larger than 1/8" (3 mm). Follow manufacturer's installation recommendations for use with DensGlass Sheathing, and design authority specifications.

*Note: Consult with local building code, design professional, owner or cladding manufacturer for water-resistive barrier requirements and compatibility with the wall cladding.*

---

## Protection of Penetrations

All penetrations should be protected to prevent air and water infiltration. Follow building code, door/window manufacturer or design authority's recommendations for flashing around openings, abutments to dissimilar materials and wall terminations.

---

## Air Barrier Compliance

Per the International Energy Conservation Code® (IECC), gypsum sheathing such as DensGlass Sheathing complies with the prescriptive code language for use as a continuous air barrier when the joints and openings are properly sealed.

---

## For a Sheathing, with an integrated water-resistive barrier and air barrier please refer to the DensElement Barrier System

The DensElement™ Barrier System with AquaKOR™ Technology integrates a water-resistive and air barrier (WRB-AB) directly into the exterior wall assembly. This eliminates the need for building wraps, peel-and-stick membranes, or fluid-applied membranes to the field of the sheathing. For additional information on the DensElement™ Barrier System, visit [www.denselement.com](http://www.denselement.com).

## Fire-Rated Assemblies

5/8" DensGlass® Fireguard® Sheathing is UL and ULC certified as **Type DGG** and is included in numerous assembly designs investigated by UL and ULC for hourly fire resistance ratings.

In addition, 5/8" DensGlass Fireguard Sheathing is certified as "Type X" in accordance with ASTM C1177 and may replace 5/8" gypsum sheathing specified as Type X in generic fire-rated wall assemblies. Generic systems in the GA-600 Fire Resistance Design Manual are applicable to the products of any manufacturer, including Georgia-Pacific Gypsum, provided they meet certain standards set forth in such manual, such as Type X gypsum board per applicable ASTM standard with specified thickness and size described in the design. "Type X" as used in this technical guide designates gypsum board manufactured and tested in accordance with specific ASTM standards for increased fire resistance beyond regular gypsum board. Please consult the ASTM standard for the specific product (for example, ASTM C1177 for glass mat gypsum substrate for use as sheathing) for further information and significance of use.

**Proprietary GA-600 Designs:** Assemblies listed as proprietary in the GA-600 Fire Resistance Design Manual only list one product per manufacturer and may not include all products referenced in the illustrations below. Please consult the specified UL, ULC, cUL or other fire listing or test for a complete list of approved products.

**The following design assemblies are for illustrative purposes only. Consult the appropriate fire resistance directory or test report for complete assembly information. For additional fire safety information concerning DensGlass Sheathing, visit [www.buildgp.com/safetyinfo](http://www.buildgp.com/safetyinfo).**

### 1-Hour Fire Rating

Design Reference: UL U305, U337, WHI 495-0702, GA WP 8130

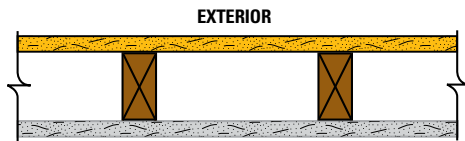

### 30-34 STC Sound Trans.

Test Reference: OR 64-8

Wall Thickness: 4-3/4" (121 mm)

Weight per Sq. Ft.: 7.5 psf (37 Kg/m<sup>2</sup>)

Exterior: 5/8" (15.9 mm) DensGlass® Fireguard® Sheathing applied vertically (U337, U305) or horizontally (U305) to 2" (51 mm) x 4" (102 mm) wood studs 16" (406 mm) o.c. with 1-3/4" (45 mm) galvanized roofing nails 7" (178 mm) o.c. for all framing members. Exterior surface covered with weather exposed cladding or finish system.

Interior: 5/8" (15.9 mm) DensArmor Plus® Fireguard® interior panels or 5/8" (15.9 mm) ToughRock® Fireguard X® gypsum board applied vertically (U337, U305) or horizontally (U305) to studs with 1-7/8" (48 mm) 6d coated nails 7" (178 mm) o.c. Stagger joints each side.

### 1-Hour Fire Rating

Design Reference: UL U309, cUL U309, GA WP 3510, GA WP 8105

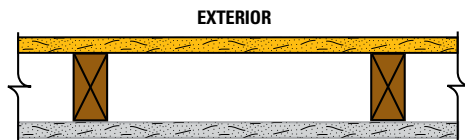

### 35-39 STC Sound Trans.

Test Reference: NGC 2404

Wall Thickness: 4-7/8" (124 mm)

Weight per Sq. Ft.: 7.0 psf (34 Kg/m<sup>2</sup>)

Exterior: 5/8" (15.9 mm) DensGlass Fireguard Sheathing applied vertically or horizontally to 2" (51 mm) x 4" (102 mm) wood studs spaced 24" (610 mm) o.c. with 1-3/4" (45 mm) galvanized roofing nails 7" (178 mm) o.c.

Interior: 5/8" (15.9 mm) DensArmor Plus Fireguard interior panels or 5/8" (15.9 mm) ToughRock Fireguard X gypsum board applied vertically or horizontally to framing with 1-7/8" (48 mm) 6d coated nails 7" (178 mm) o.c.

### 2-Hour Fire Rating

Design Reference: UL U301, cUL U301, GA WP 8416

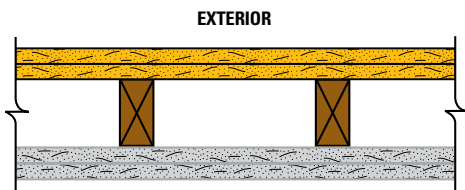

### 40-44 STC Sound Trans.

Test Reference: NGC-2363

Wall Thickness: 6-1/8" (156 mm)

Weight per Sq. Ft.: 12.0 psf (58 Kg/m<sup>2</sup>)

Exterior: Two layers 5/8" (15.9 mm) DensGlass Fireguard Sheathing applied vertically or horizontally to 2" (51 mm) x 4" (102 mm) wood studs 16" (406 mm) o.c. Base layer attached with 1-7/8" (48 mm) galvanized roofing nails 6" (152 mm) o.c. Face layer attached with 2-3/8" (60 mm) galvanized roofing nails 8" (203 mm) o.c. Stagger joints between layers and on base layer of both sides.

Interior: Two layers 5/8" (15.9 mm) DensArmor Plus Fireguard interior panels or 5/8" (15.9 mm) ToughRock Fireguard X gypsum board applied horizontally or vertically to framing. Base layer attached with 1-7/8" (48 mm) 6d cement coated nails 6" (152 mm) o.c. Face layer attached with 2-3/8" (60 mm) 6d cement coated nails 8" (203 mm) o.c. Stagger joints between layers and on base layer of both sides. Sound tested with studs 16" (406 mm) o.c. and nails for base layer spaced 6" (152 mm) o.c.

**Fire-Rated Assemblies continued**

**2-Hour Fire Rating**

Design Reference: UL U302, cUL U302, GA WP 8410

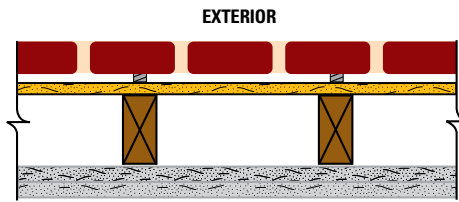

Wall Thickness: 10-1/8" (257 mm)

Exterior: One layer 1/2" (12.7 mm) DensGlass® Sheathing applied vertically or horizontally to studs 16" (406 mm) o.c. with 1-3/4" (45 mm) galvanized roofing nails 6" (152 mm) o.c. Face layer is 2" (51 mm) x 4" (102 mm) x 8" (51 mm x 102 mm x 203 mm) clay brick with 1" (25 mm) air space between brick and exterior sheathing. 20-gauge (30 mils) galvanized wire ties attached to each stud with 8d coated nails 2-3/8" (60 mm) as described above, located at every sixth course of bricks.

Interior: Two layers 5/8" (15.9 mm) DensArmor Plus® Fireguard® interior panels or 5/8" (15.9 mm) ToughRock® Fireguard X® gypsum board applied vertically or horizontally to 2" (51 mm) x 4" (102 mm) wood studs 16" (406 mm) o.c. Base layer attached with 1-7/8" (48 mm) 6d coated nails 8" (203 mm) o.c. Face layer attached with 2-3/8" (60 mm) coated nails 8" (203 mm) o.c.

**Generic 2-Hour Fire Rating**

Design Reference: UC ES-6898 12-21-67, GA WP 8420

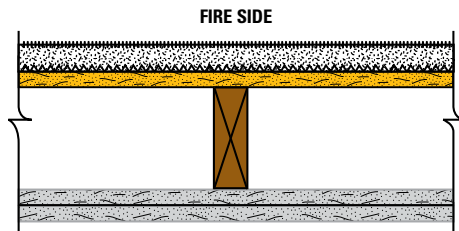

Wall Thickness: 8-5/8" (219 mm)

Exterior: Base layer 5/8" (15.9 mm) DensGlass® Fireguard® Sheathing retardant treated 2" (51 mm) x 6" (152 mm) wood studs 16" (406 mm) o.c. with 6d coated nails, 1-7/8" (48 mm) long, 0.0915" (2 mm) shank, 1/4" (6 mm) heads, 12" (305 mm) o.c. and covered with a single layer fire resistant protective weather retarder paper stapled along each edge at 16" (406 mm) o.c. Galvanized self-furring wire mesh applied over sheathing with 8d galvanized roofing nails, 2-3/8" (60 mm) long, 0.113" (3 mm) shank, 9/32" (7 mm) heads, 6" (152 mm) o.c. Cement-stucco applied over wire mesh in two 1/2" (12.7 mm) thick coats with bonding agent applied between coats.

Interior: Base layer 5/8" (15.9 mm) DensArmor Plus Fireguard interior panels or 5/8" (15.9 mm) ToughRock Fireguard X gypsum board applied vertically to studs with 6d coated nails, 1-7/8" (48 mm) long, 0.0915" (2 mm) shank, 1/4" (6 mm) heads, 12" (305 mm) o.c. Face layer 5/8" (15.9 mm) DensArmor Plus Fireguard interior panels or 5/8" (15.9 mm) ToughRock Fireguard X gypsum board applied horizontally to studs with 8d coated nails, 2-3/8" (60 mm) long, 0.113" (3 mm) shank, 9/32" (7 mm) heads, 8" (203 mm) o.c. at edges and 12" (305 mm) o.c. at intermediate studs.

**1-Hour Fire Rating**

Design Reference: UL U465, cUL U465, GA WP 8007

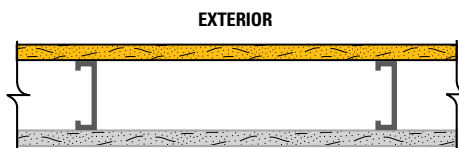

**45-49 STC Sound Trans.**

Test Reference: RAL TL 99-103

Wall Thickness: 4-7/8" (124 mm)

Weight per Sq. Ft.: 6 psf (29 Kg/m<sup>2</sup>)

Exterior: 5/8" (15.9 mm) DensGlass Fireguard Sheathing applied vertically to min. 3-5/8" (92 mm) corrosion resistant 25-gauge (18 mils) steel studs 24" (610 mm) o.c. with 1" (25 mm) corrosion resistant bugle head screws 8" (203 mm) o.c. at board edges and 8" (203 mm) at intermediate studs.

Interior: 5/8" (15.9 mm) DensArmor Plus Fireguard interior panels or 5/8" (15.9 mm) ToughRock Fireguard X gypsum board applied vertically to framing with 1" (25 mm) Type S bugle head screws 8" (203 mm) o.c. at board edges and 12" (305 mm) at intermediate studs. Sound tested with 3" mineral fiber, 2.5 psf, in stud space.

**1-Hour Fire Rating**

Design Reference: UL U425, cUL U425, GA WP 8006

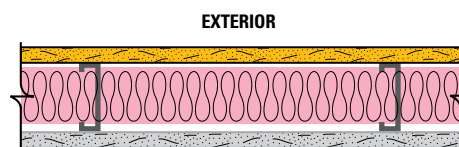

Wall Thickness: 4-3/4" (121 mm)

Weight per Sq. Ft.: 6 psf (29 Kg/m<sup>2</sup>)

Exterior: 5/8" (15.9 mm) DensGlass Fireguard Sheathing applied vertically to min. 3-1/2" (89 mm) corrosion resistant 20-gauge (30 mils) steel studs 24" (610 mm) o.c. with 1" (25 mm) Type S corrosion resistant bugle head screws 8" (203 mm) o.c.

Interior: 5/8" (15.9 mm) DensArmor Plus Fireguard interior panels or 5/8" (15.9 mm) ToughRock Fireguard X gypsum board applied vertically to framing with 1" (25 mm) Type S bugle head screws 12" (305 mm) o.c. Insulation to completely fill stud cavity.

## Fire-Rated Assemblies *continued*

### 1-Hour Fire Rating

Design Reference: GA WP 8122

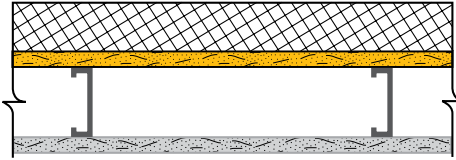

Partition Thickness: 6" – 7" (152 – 178 mm) Varies based on insulation thickness  
Weight per Sq. Ft.: 7.0 psf (34 Kg/m<sup>2</sup>)

Exterior: 5/8" (15.9 mm) DensGlass® Fireguard® Sheathing applied vertically to 3-5/8" (92 mm) 18-gauge (43 mils) steel studs 16" (406 mm) o.c. with #6 x 1-1/4" (32 mm) self-drilling, corrosion-resistant, bugle head, drywall screws 8" (203 mm) o.c. at edges and ends and 8" (203 mm) o.c. at intermediate studs. Proprietary polymer modified exterior insulation and finish system applied over sheathing. 2" (51 mm) maximum foam-plastic thickness.

Interior: 5/8" (15.9 mm) ToughRock® Fireguard X® gypsum board or 5/8" (15.9 mm) DensArmor Plus® Fireguard® interior panels applied vertically to studs with #6 x 1-1/4" (32 mm) self-drilling, bugle head drywall screws 8" (203 mm) o.c. at edges and ends and 12" (305 mm) o.c. at intermediate studs.

### 1-Hour Fire Rating

Design Reference: GA WP 8123

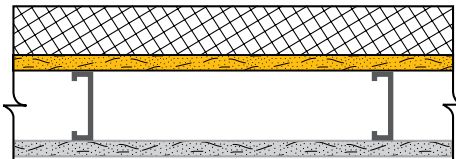

Partition Thickness: 6" – 9" (152 – 229 mm) Varies based on insulation thickness  
Weight per Sq. Ft.: 7.0 psf (34 Kg/m<sup>2</sup>)

Exterior: 5/8" (15.9 mm) DensGlass Fireguard Sheathing applied vertically to 3-5/8" (92 mm) 18-gauge (43 mils) steel studs 24" (610 mm) o.c. with #6 x 1-1/4" (32 mm) self-drilling, corrosion-resistant, bugle head, drywall screws 8" (203 mm) o.c. at edges and ends and 8" (203 mm) o.c. at intermediate studs. Polymer-based exterior insulation and finish system applied over sheathing. 4" (102 mm) maximum foam-on-plastic thickness.

Interior: One layer 5/8" (15.9 mm) ToughRock Fireguard X gypsum board or 5/8" (15.9 mm) DensArmor Plus Fireguard interior panels applied vertically to studs with #6 x 1-1/4" (32 mm) self-drilling, bugle head drywall screws 8" (203 mm) o.c. at edges and ends and 12" (305 mm) o.c. at intermediate studs.

### 2-Hour Fire Rating

Design Reference: UL U425, cUL U425, GA WP 1716, GA WP 8203

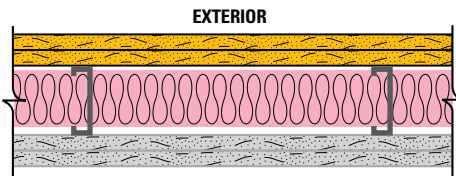

### 40-44 STC Sound Trans.

Test Reference: NGC-2250

Wall Thickness: 6" (152 mm)

Weight per Sq. Ft.: 11.0 psf (54 Kg/m<sup>2</sup>)

Exterior: Two layers 5/8" (15.9 mm) DensGlass Fireguard Sheathing applied vertically to min. 3-1/2" (89 mm) corrosion resistant 20-gauge (30 mils) steel studs 24" (610 mm) o.c. Base layer attached with 1" (25 mm) Type S-12 corrosion resistant bugle head screws 8" (203 mm) o.c. Face layer attached with 1-5/8" (41 mm) Type S-12 corrosion resistant bugle head screws spaced 8" (203 mm) o.c. Joints staggered.

Interior: Two layers 5/8" (15.9 mm) DensArmor Plus Fireguard interior panels or 5/8" (15.9 mm) ToughRock Fireguard X gypsum board applied vertically to framing. Base layer attached with 1" (25 mm) Type S-12 bugle head screws 12" (305 mm) o.c. Face layer attached with 1-5/8" (41 mm) Type S-12 bugle head screws spaced 12" (305 mm) o.c. Joints staggered. Insulation to completely fill stud cavity. (Load Bearing: 80% of design load)

### 2-Hour Fire Rating

Design Reference: UL U411, cUL U411, GA WP 1524

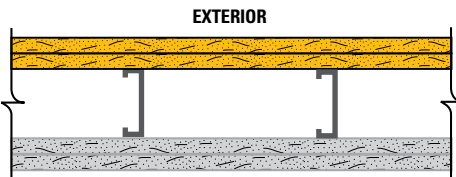

### 55-59 STC Sound Trans.

Test Reference: IRC IR 761

Wall Thickness: 6 1/8" (156 mm)

Weight per Sq. Ft.: 10 psf (49 Kg/m<sup>2</sup>)

Exterior: Two layers 5/8" (15.9 mm) DensGlass Fireguard Sheathing applied vertically to min. 2-1/2" (64 mm) corrosion resistant 25-gauge (18 mils) steel studs 24" (610 mm) o.c. Base layer attached with 1" (25 mm) Type S corrosion resistant bugle head screws 16" (406 mm) o.c. Face layer attached with 1-5/8" (41 mm) Type S corrosion resistant bugle head screws spaced 8" (203 mm) o.c. Joints staggered.

Interior: Two layers 5/8" (15.9 mm) DensArmor Plus Fireguard or 5/8" (15.9 mm) ToughRock Fireguard X gypsum board applied vertically to framing. Base layer attached with 1" (25 mm) Type S bugle head screws 16" (406 mm) o.c. Face layer attached with 1-5/8" (41 mm) Type S bugle head screws spaced 16" (406 mm) o.c. in the field and along vertical edges and 12" (305 mm) o.c. to the floor and ceiling runners. Joints staggered. Batt or blanket insulation optional. Sound tested with 3-1/2" (89 mm) fiberglass insulation.

---

## Delivery, Handling and Storage

All materials shall be delivered in original bundles bearing the brand name, if any; applicable standard designation; and name of the manufacturer or supplier for whom the product is manufactured. The plastic packaging used to wrap gypsum panel products for rail and/or truck shipment is intended to provide temporary protection from moisture exposure during transit only and is not intended to provide protection during storage after delivery. Such plastic packaging shall be removed immediately upon receipt of the shipment. **WARNING:** Failure to remove protective plastic shipping covers can result in condensation which can lead to damage, including mold.

All materials should be kept dry. Gypsum panel products shall be neatly stacked flat with care taken to prevent sagging or damage to edges, ends and surfaces. Gypsum panel products and accessories shall be properly supported on risers on a level platform, and fully protected from weather, direct sunlight exposure, and condensation. Gypsum panel products shall be stacked flat rather than on edge or end. **WARNING:** Gypsum panel products stacked on edge or end can be unstable and present a serious hazard in the workplace should they accidentally topple.

Refer to *Handling Gypsum Panel Products, GA-801*, for proper storage and handling requirements.

*Reference: Application and Finishing of Gypsum Panel Products, GA-216, Gypsum Association.*

---

## Recommendations and Limitations for Use

The following recommendations and limitations are important to ensure the proper use and benefits of DensGlass® Sheathing. Failure to strictly adhere to such recommendations and limitations may void the limited warranty provided by Georgia-Pacific Gypsum for such product. For additional warranty details, please go to [www.buildgp.com/warranties](http://www.buildgp.com/warranties).

DensGlass Sheathing is resistant to normal weather conditions, but it is not intended for immersion in water. Cascading roof/floor water should be directed away from the sheathing until appropriate drainage is installed.

Avoid any condition that will create moisture in the air and condensation on the exterior walls during periods when the exterior temperature is lower than the interior. The use of forced air heaters creates volumes of water vapor which, when not properly vented, can condense on building materials. The use of these heaters and any resulting damage is not the responsibility of Georgia-Pacific Gypsum. Consult heater manufacturer for proper use and ventilation.

When DensGlass Sheathing panels are used in slanted wall applications, that portion of the wall must be temporarily protected from the elements by the use of a water-resistant barrier prior to application of the cladding. Do not allow water to pond or settle on sheathing. Also, exposed wall ends such as those that may be found in parapets must be covered to prevent water from infiltrating the cavity.

Georgia-Pacific Gypsum does not warrant and is not responsible or liable for the performance of any cladding, coating, finishes, coverings or other materials or exterior systems applied over DensGlass Sheathing. The suitability and compatibility of any system is the responsibility of the system manufacturer or design authority.

Brackets to support heavy cladding such as tile and marble should not be installed over DensGlass Sheathing.

Do not laminate DensGlass Sheathing to masonry surfaces; use furring strips or framing.

DensGlass Sheathing is not intended for roof applications. For roof applications, consult our DensDeck® Roof Board brochure.

DensGlass Sheathing is not intended for interior or exterior tile applications. For interior tile applications, consult our DensShield® Tile Backer brochure.

DensGlass Sheathing should not be used in lieu of plywood where required.

Do not apply DensGlass Sheathing below grade.

For all installations, design details such as fasteners, sealants and control joints per system specifications must be properly installed. Openings and penetrations must be properly flashed and sealed. Failure to do so will void the warranty.

Do not use DensGlass Sheathing as a base for nailing or mechanical fastening. Fasteners should be flush to the face of the board, not countersunk.

When DensGlass Sheathing is used in panelized construction, install panels so panel joints are tightly butted together on both horizontal and vertical joints.

Georgia-Pacific recommends as a best practice that cut sheathing edges in panelized construction should be sealed. DensDefy™ Liquid Flashing has been determined to be a product that is effective in sealing cut sheathing edges and has been tested internally for adhesion to Georgia-Pacific sheathing products.

**COMMONLY USED METRIC CONVERSIONS**
**Gypsum Board Thickness**

1/4 in. – 6 mm  
 1/2 in. – 12.7 mm  
 5/8 in. – 15.9 mm  
 1 in. – 25.4 mm

**Gypsum Board Width**

2 ft. – 610 mm  
 4 ft. – 1219 mm  
 32 in. – 813 mm

**Gypsum Board Length**

4 ft. – 1219 mm  
 5 ft. – 1524 mm  
 8 ft. – 2438 mm  
 9 ft. – 2743 mm  
 10 ft. – 3048 mm  
 12 ft. – 3658 mm

**Framing Spacing**

16 in. – 406 mm  
 24 in. – 610 mm

**Fastener Spacing**

2 in. – 51 mm  
 2.5 in. – 64 mm  
 7 in. – 178 mm  
 8 in. – 203 mm  
 12 in. – 305 mm  
 16 in. – 406 mm  
 24 in. – 610 mm

**Temperature**

40°F – 5°C  
 50°F – 10°C  
 125°F – 52°C

# High-Performance Gypsum Products from Georgia-Pacific

|  |  |
|--|--|
| <b>DensDeck® Roof Board</b>                            | Fiberglass mat roof board used as the ideal thermal barrier and cover board to improve resistance to wind uplift, hail, foot traffic, fire and mold in a broad range of commercial roofing applications. Look for DensDeck Prime and DensDeck DuraGuard Roof Boards, too.  |
| <b>DensGlass® Sheathing</b>                            | The original and universal standard of exterior gypsum sheathing offers superior weather resistance, with a 12-month limited warranty against delamination or deterioration during exposure to normal weather conditions. Look for the familiar GOLD color. GREENGUARD listed for microbial resistance.  |
| <b>DensGlass® Shaftliner</b>                           | These specially-designed panels are perfect for moisture-prone vertical or horizontal shafts, interior stairwells and area separation wall assemblies. 12-month limited warranty against delamination or deterioration during exposure to normal weather conditions. GREENGUARD listed for microbial resistance.   |
| <b>DensArmor Plus® Interior Panel</b>                  | High-performance interior panel accelerates scheduling because it can be installed before the building is dried-in. A 12-month limited warranty against delamination or deterioration during exposure to normal weather conditions. GREENGUARD and GREENGUARD Gold certified for low VOC emissions. Listed in CHPS® High Performance Product Database as a low emitting product. GREENGUARD listed for microbial resistance. |
| <b>DensArmor Plus® Abuse-Resistant Interior Panel</b>  | With the same benefits as the DensArmor Plus® Interior Panel, these also offer added resistance to scuffs, abrasions and surface indentations; ideal for healthcare facilities and schools. GREENGUARD and GREENGUARD Gold certified for low VOC emissions. Listed in CHPS® High Performance Product Database as a low emitting product. GREENGUARD listed for microbial resistance.   |
| <b>DensArmor Plus® Impact-Resistant Interior Panel</b> | With even greater durability than abuse-resistant panels, these have an embedded impact-resistant mesh for the ultimate resistance in high traffic areas; ideal for healthcare facilities, schools and correctional institutions. GREENGUARD and GREENGUARD Gold certified for low VOC emissions. Listed in CHPS® High Performance Product Database as a low emitting product. GREENGUARD listed for microbial resistance.   |
| <b>DensShield® Tile Backer</b>                         | Acrylic-coated tile backer stops moisture at the surface. Lightweight and strong, they are built for speed on the job site. Conforms to requirements of 2012 IBC/IRC Code. GREENGUARD listed for microbial resistance.   |
| <b>ToughRock® Gypsum Board</b>                         | Paper-faced line of gypsum panels for a variety of applications including interior wall and ceiling applications, abuse-resistant boards, and panels for use in fire-rated assemblies. ToughRock products are GREENGUARD and GREENGUARD Gold certified for low VOC emissions. Listed in CHPS® High Performance Product Database as a low emitting product.   |
| <b>ToughRock® Mold-Guard™ Gypsum Board</b>             | ToughRock Mold-Guard Gypsum Board products have enhanced mold resistance in comparison to regular ToughRock® Gypsum Boards. They are GREENGUARD and GREENGUARD Gold Certified for low VOC emissions and are listed in the CHPS® High Performance Product Database as a low emitting product. The ToughRock Mold-Guard Gypsum Board is also listed as GREENGUARD microbial resistant.   |
| <b>DensElement™ Barrier System</b>                     | DensElement Barrier System delivers the same advantages of DensGlass Sheathing while incorporating AquaKOR™ Technology, a water barrier system that maintains high vapor permeability mitigating the risk of moisture in the wall cavity. With this innovation built into its core, DensElement eliminates the need for additional barrier (WRB-AB) saving time, labor and materials.  |



## Georgia-Pacific Gypsum

U.S.A. Georgia-Pacific Gypsum LLC  
CANADA Georgia-Pacific Canada LP

### SALES INFORMATION AND ORDER PLACEMENT

U.S.A. West: **1-800-824-7503**  
Midwest: **1-800-876-4746**  
South Central: **1-800-231-6060**  
Southeast: **1-800-327-2344**  
Northeast: **1-800-947-4497**

CANADA Canada Toll Free: **1-800-387-6823**  
Quebec Toll Free: **1-800-361-0486**

### TECHNICAL HOTLINE

U.S.A. and Canada: **1-800-225-6119**



### TRADEMARKS –

Unless otherwise noted, all trademarks are owned by or licensed to Georgia-Pacific Gypsum LLC. BASF is a registered trademark of BASF. LEED, USGBC and related logo are trademarks owned by the U.S. Green Building Council and are used by permission. CHPS is a trademark owned by Collaborative for High Performance Schools Inc. International Energy Conservation Code is a registered mark of the International Code Council.

### WARRANTIES, REMEDIES AND TERMS OF SALE –

For current warranty information, please go to [www.buildgp.com/warranties](http://www.buildgp.com/warranties) and select the applicable product. All sales by Georgia-Pacific are subject to our Terms of Sale available at [www.buildgp.com/tc](http://www.buildgp.com/tc).

### UPDATES AND CURRENT INFORMATION –

The information in this document may change without notice. Visit our website at [www.gpgypsum.com](http://www.gpgypsum.com) for updates and current information.

**CAUTION: For product fire, safety and use information, go to [buildgp.com/safetyinfo](http://buildgp.com/safetyinfo) or call 1-800-225-6119.**

### HANDLING AND USE –

**CAUTION:** This product contains fiberglass facings which may cause skin irritation. Dust and fibers produced during the handling and installation of the product may cause skin, eye and respiratory tract irritation. Avoid breathing dust and minimize contact with skin and eyes. Wear long sleeve shirts, long pants and eye protection. Always maintain adequate ventilation. Use a dust mask or NIOSH/MSHA approved respirator as appropriate in dusty or poorly ventilated areas.

### FIRE SAFETY CAUTION –

Passing a fire test in a controlled laboratory setting and/or certifying or labeling a product as having a one-hour, two-hour, or any other fire resistance or protection rating and, therefore, as acceptable for use in certain fire rated assemblies/systems, does not mean that either a particular assembly/system incorporating the product, or any given piece of the product itself, will necessarily provide one-hour fire resistance, two-hour fire resistance, or any other specified fire resistance or protection in an actual fire. In the event of an actual fire, you should immediately take any and all actions necessary for your safety and the safety of others without regard for any fire rating of any product or assembly/system.