

# Thread and Drill Point Lengths

Interior Wood	02
Exterior Wood	08
Light-Gauge Steel	17
Heavy-Gauge Steel	28

# Thread Length

## Interior Wood



### Interior Wood: PS1001

Item No.	
3EL	
3ELZ	
Screw Length: 3 in.	
Thread Length: 1 1/2 in.	

Item No.	
5EL	
5ELZ	
Screw Length: 5 in.	
Thread Length: 1 1/2 in.	

Item No.	
4EL	
4ELZ	
Screw Length: 4 in.	
Thread Length: 1 1/2 in.	

### Interior Wood: PS1003

Item No.	
100	
100Z	
100YZ	
Screw Length: 1 in.	
Thread Length: 13/16 in.	

Item No.	
40012	
Screw Length: 1 1/2 in.	
Thread Length: 15/16 in.	

Item No.	
200	
200YZ	
Screw Length: 1 1/8 in.	
Thread Length: 15/16 in.	

Item No.	
400	
C400	
400Z	
400YZ	
C400YZ	
Screw Length: 1 5/8 in.	
Thread Length: 1 7/16 in.	

Item No.	
300	
300HP	
C300	
300Z	
300YZ	
C300YZ	
Screw Length: 1 1/4 in.	
Thread Length: 1 1/16 in.	

Item No.	
C375	
375YZ	
Screw Length: 1 3/4 in.	
Thread Length: 1 3/16 in.	

# Thread Length

## Interior Wood



### Interior Wood: PS1003 (continued)

Item No.		2 in.
500		1 13/16 in.
C500		
500Z		
500YZ		
Screw Length: 2 in.		Thread Length: 1 13/16 in.

Item No.		3 in.
1100		2 in.
1100Z		
1100YZ		
Screw Length: 3 in.		Thread Length: 2 in.

Item No.		2 1/4 in.
600		2 in.
600YZ		
Screw Length: 2 1/4 in.		Thread Length: 2 in.

Item No.		3 1/2 in.
1200		2 in.
1200Z		
1200YZ		
Screw Length: 3 1/2 in.		Thread Length: 2 in.

Item No.		2 1/2 in.
900		2 in.
900Z		
900YZ		
Screw Length: 2 1/2 in.		Thread Length: 2 in.

Item No.		4 in.
1300		2 in.
1300Z		
1300YZ		
Screw Length: 4 in.		Thread Length: 2 in.

Item No.		2 1/2 in.
C900		3/16 in.
		3/16 in.
		2 in.
		3/16 in.
Screw Length: 2 1/2 in.		Upper Thread Length: 3/16 in.
Lower Thread Length: 2 in.		Unthreaded Length: 3/16 in.

Item No.		4 in.
1300F		3 3/4 in.
Screw Length: 4 in.		Thread Length: 3 3/4 in.

### Interior Wood: PS1016

Item No.		1 1/2 in.
12		1 5/16 in.
C12		
12Z		
Screw Length: 1 1/2 in.		Thread Length: 1 5/16 in.

Item No.		2 in.
12-2		1 13/16 in.
Screw Length: 2 in.		Thread Length: 1 13/16 in.

# Thread Length

## Interior Wood

# GRABBER®

CONSTRUCTION PRODUCTS

### Interior Wood: PS1020

Item No.		
78100Z		
Screw Length: 1 in.		Thread Length: 11/16 in.

Item No.		
78118YZ		
Screw Length: 1 1/8 in.		Thread Length: 3/4 in.

Item No.		
78125Z		
78125YZ		
Screw Length: 1 1/4 in.		Thread Length: 13/16 in.

Item No.		
78150Z		
78150YZ		
WL8150YZ		
Screw Length: 1 1/2 in.		Thread Length: 1 in.

Item No.		
78175Z		
78175YZ		
W8175YZ		
Screw Length: 1 3/4 in.		Thread Length: 1 3/16 in.

Item No.		
78200Z		
78200YZ		
WL8200YZ		
Screw Length: 2 in.		Thread Length: 1 3/8 in.

Item No.		
782508Z		
78250Z		
782508YZ		
78250YZ		
Screw Length: 2 1/2 in.		Thread Length: 1 11/16 in.

Item No.		
783008Z		
78300Z		
7830010YZ		
783008YZ		
78300YZ		
Screw Length: 3 in.		Thread Length: 2 in.

Item No.		
78350YZ		
Screw Length: 3 1/2 in.		Thread Length: 2 3/8 in.

Item No.		
78400Z		
78400YZ		
WL10400YZ		
Screw Length: 4 in.		Thread Length: 2 11/16 in.

Item No.		
78500YZ		
Screw Length: 5 in.		Thread Length: 2 in.

Item No.		
78600YZ		
Screw Length: 6 in.		Thread Length: 2 in.

# Thread Length

Interior Wood



## Interior Wood: PS1020 (continued)

<b>Item No.</b>		
C8175L3YZ		
Screw Length: 1 3/4 in.	Upper Thread Length: 3/16 in.	
Lower Thread Length: 1 1/16 in.	Unthreaded Length: 5/16 in.	

<b>Item No.</b>		
C8250SFJBW		
Screw Length: 2 1/2 in.	Upper Thread Length: 1/4 in.	
Lower Thread Length: 1 11/16 in.	Unthreaded Length: 7/16 in.	

<b>Item No.</b>		
C8200L3YZ		
Screw Length: 2 in.	Upper Thread Length: 3/16 in.	
Lower Thread Length: 1 5/16 in.	Unthreaded Length: 5/16 in.	

<b>Item No.</b>		
C8300L3YZ		
Screw Length: 3 in.	Upper Thread Length: 3/16 in.	
Lower Thread Length: 2 1/16 in.	Unthreaded Length: 1/2 in.	

<b>Item No.</b>		
C8250L3YZ		
Screw Length: 2 1/2 in.	Upper Thread Length: 3/16 in.	
Lower Thread Length: 1 11/16 in.	Unthreaded Length: 7/16 in.	

## Interior Wood: PS1026

<b>Item No.</b>		
90		
902Q		
902QCT		
Screw Length: 1 1/2 in.	Thread Length: 7/8 in.	

<b>Item No.</b>		
90-4		
902Q4		
Screw Length: 1 1/4 in.	Thread Length: 7/8 in.	

# Thread Length

Interior Wood



## Interior Wood: PS1028

Item No.		1 in.	13/16 in.
108			
Screw Length: 1 in.		Thread Length: 13/16 in.	

Item No.		1 5/8 in.	1 7/16 in.
408			
C408			
Screw Length: 1 5/8 in.		Thread Length: 1 7/16 in.	

Item No.		1 1/4 in.	1 1/16 in.
308			
C308			
Screw Length: 1 1/4 in.		Thread Length: 1 1/16 in.	

Item No.		2 in.	1 13/16 in.
508			
Screw Length: 2 in.		Thread Length: 1 13/16 in.	

## Interior Wood: PS1031

Item No.		1 1/4 in.	3/16 in.	1/16 in.	13/16 in.
U8125YZ					
Screw Length: 1 1/4 in.		Upper Thread Length: 3/16 in.			
Lower Thread Length: 13/16 in.		Unthreaded Length: 1/16 in.			

Item No.		2 in.	7/16 in.	1/8 in.	1 1/4 in.
U8200YZ					
Screw Length: 2 in.		Upper Thread Length: 7/16 in.			
Lower Thread Length: 1 1/4 in.		Unthreaded Length: 1/8 in.			

Item No.		1 1/2 in.	3/16 in.	1/16 in.	1 1/16 in.
U8150YZ					
Screw Length: 1 1/2 in.		Upper Thread Length: 3/16 in.			
Lower Thread Length: 1 1/16 in.		Unthreaded Length: 1/16 in.			

Item No.		2 1/2 in.	7/16 in.	1/4 in.	1 5/8 in.
U9250YZ					
Screw Length: 2 1/2 in.		Upper Thread Length: 7/16 in.			
Lower Thread Length: 1 5/8 in.		Unthreaded Length: 1/4 in.			

# Thread Length

Interior Wood



## Interior Wood: PS1031 (continued)

<b>Item No.</b>		
<b>U10300YZ</b>		
<b>Screw Length: 3 in.</b>	<b>Upper Thread Length: 7/16 in.</b>	
<b>Lower Thread Length: 1 15/16 in.</b>	<b>Unthreaded Length: 3/8 in.</b>	

<b>Item No.</b>		
<b>U10400YZ</b>		
<b>Screw Length: 4 in.</b>	<b>Upper Thread Length: 7/16 in.</b>	
<b>Lower Thread Length: 2 1/16 in.</b>	<b>Unthreaded Length: 1 5/16 in.</b>	

<b>Item No.</b>		
<b>U10350YZ</b>		
<b>Screw Length: 3 1/2 in.</b>	<b>Upper Thread Length: 7/16 in.</b>	
<b>Lower Thread Length: 1 13/16 in.</b>	<b>Unthreaded Length: 1 1/16 in.</b>	

# Thread Length

Exterior Wood

**GRABBER**  
CONSTRUCTION PRODUCTS

Exterior Wood: PS1019

Item No.	
9212G	
BCDS212G2	
9212R	
9212B	
BCDS212B	
9212T	
Screw Length: 2 1/2 in.      Upper Thread Length: 1/2 in.	
Lower Thread Length: 1 3/4 in.	

Item No.	
GCDS234B	
GTCDS234B	
Screw Length: 2 3/4 in.      Upper Thread Length: 1/2 in.	
Lower Thread Length: 2 in.	

Exterior Wood: PS1022

Item No.	
12RG	
Screw Length: 1 1/2 in.      Thread Length: 1 5/16 in.	

# Thread Length

## Exterior Wood



### Exterior Wood: PS1032

Item No.	1 5/8 in.	7/8 in.
GTSTTR158		
GTPHTR158W		
Screw Length: 1 5/8 in.		Thread Length: 7/8 in.

Item No.	1 5/8 in.	1 in.
GT7158G		
Screw Length: 1 5/8 in.		Thread Length: 1 in.

Item No.	2 1/4 in.	1 1/8 in.
GT7225G		
GTPHTR225W		
GTSTTR225		
Screw Length: 2 1/4 in.		Thread Length: 1 1/8 in.

Item No.	3 in.	1 3/8 in.
GTSTTR300		
Screw Length: 3 in.		Thread Length: 1 3/8 in.

Item No.	3 in.	1 1/2 in.
GT8300G		
Screw Length: 3 in.		Thread Length: 1 1/2 in.

# Thread Length

Exterior Wood



## Exterior Wood: PS1037

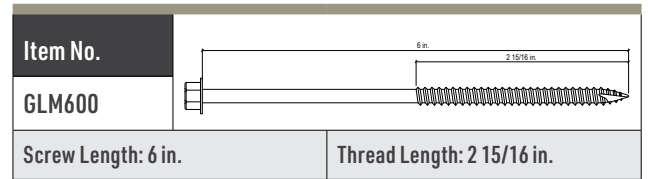
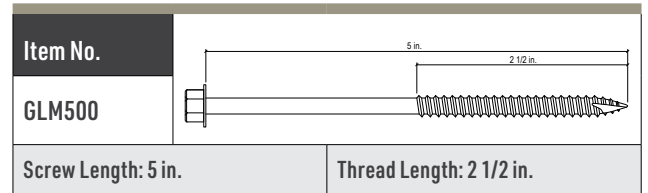
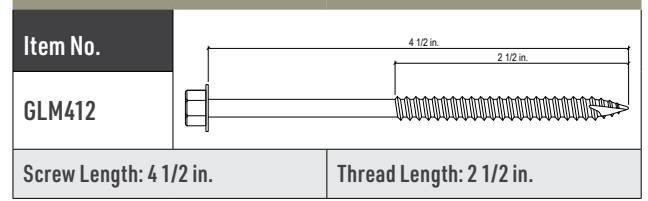
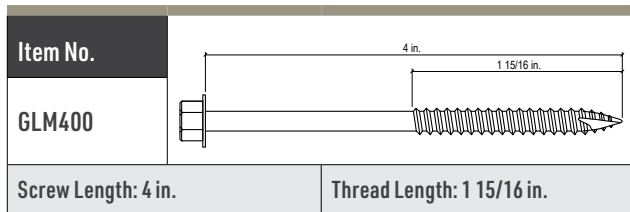
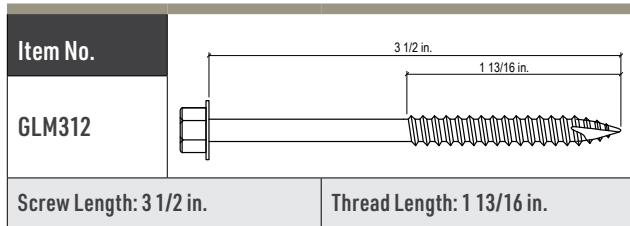
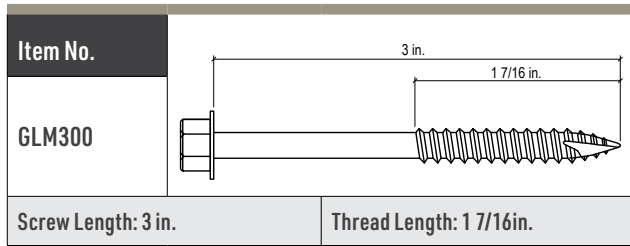
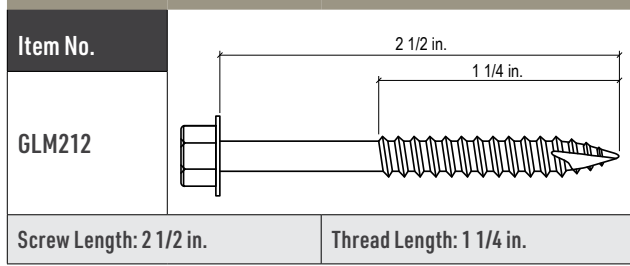

## Exterior Wood: PS1051

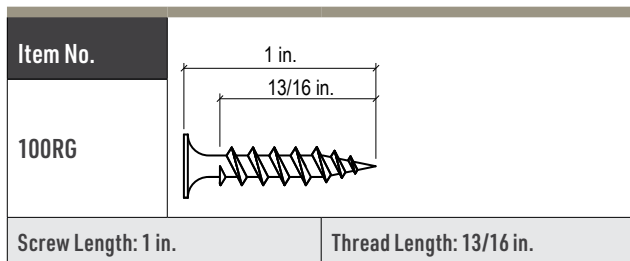

# Thread Length

## Exterior Wood



### Exterior Wood: PS1051 (continued)

Item No.		
200RG		
Screw Length: 1 1/8 in.		Thread Length: 15/16 in.

Item No.		
600RG		
Screw Length: 2 1/4 in.		Thread Length: 2 in.

Item No.		
300RG		
C300RG		
300RRG		
8300SS305		
Screw Length: 1 1/4 in.		Thread Length: 1 1/16 in.

Item No.		
10250SSQ		
Screw Length: 2 1/2 in.		Thread Length: 1 11/16 in.

Item No.		
400RG		
C400RG		
C400RRG		
Screw Length: 1 5/8 in.		Thread Length: 1 7/16 in.

Item No.		
900RG		
900RRG		
Screw Length: 2 1/2 in.		Thread Length: 2 in.

Item No.		
500RG		
C500RG		
500RRG		
C500RRG		
Screw Length: 2 in.		Thread Length: 1 13/16 in.

Item No.		
C900RG		
Screw Length: 2 1/2 in.		Upper Thread Length: 3/16 in.
Lower Thread Length: 2 in.		Unthreaded Length: 3/16 in.

# Thread Length

## Exterior Wood



### Exterior Wood: PS1051 (continued)

Item No.	
1100RG	
1100RRG	
Screw Length: 3 in.	Thread Length: 2 in.

Item No.	
1200RG	
1200RRG	
Screw Length: 3/12 in.	Thread Length: 2 in.

Item No.	
CB10300L316	
Screw Length: 3 in.	Upper Thread Length: 1/4 in.
Lower Thread Length: 2 in.	Unthreaded Length: 1/2 in.

Item No.	
1300RG	
Screw Length: 4 in.	Thread Length: 2 in.

### Exterior Wood: PS1053

Item No.	
78125BRG	
Screw Length: 1 1/4 in.	Thread Length: 13/16 in.

Item No.	
G6150G	
G6150GB	
78150BRG	
Screw Length: 1 1/2 in.	Thread Length: 1 in.

Item No.	
G6125G	
G6125GB	
Screw Length: 1 1/4 in.	Thread Length: 1 in.

Item No.	
GTST150	
Screw Length: 1 1/2 in.	Thread Length: 1 1/16 in.

Item No.	
GTST125	
Screw Length: 1 1/4 in.	Thread Length: 1 1/16 in.

# Thread Length

## Exterior Wood



### Exterior Wood: PS1053 (continued)

Item No.		
C10158JBWG2		
Screw Length: 1 5/8 in.	Thread Length: 1 7/16 in.	

Item No.		
G8225GB		
Screw Length: 2 1/4 in.	Thread Length: 1 3/8 in.	

Item No.		
78175BRG		
Screw Length: 1 3/4 in.	Thread Length: 1 3/16 in.	

Item No.		
G8250G		
G8250GB		
Screw Length: 2 1/2 in.	Thread Length: 1 1/4 in.	

Item No.		
G7200G		
G7200GB		
Screw Length: 2 in.	Thread Length: 1 1/4 in.	

Item No.		
GTST250		
GTST8250		
78250RG		
WL9250RG		
WL9250RGR		
782508BRG		
Screw Length: 2 1/2 in.	Thread Length: 1 11/16 in.	

Item No.		
78200RG		
WL8200RG		
78200BRG		
GTST200		
Screw Length: 2 in.	Thread Length: 1 3/8 in.	

Item No.		
C8250L2M		
Screw Length: 2 1/2 in.	Upper Thread Length: 1/2 in.	
Lower Thread Length: 1 1/2 in.	Unthreaded Length: 3/8 in.	

Item No.		
C8200L2M		
Screw Length: 2 in.	Thread Length: 1 13/16 in.	

# Thread Length

## Exterior Wood



### Exterior Wood: PS1053 (continued)

Item No.	
G8300G	
G9300G	
G8300GB	
G9300GB	
Screw Length: 3 in.      Thread Length: 1 1/2 in.	

Item No.	
GTST300	
78300RG	
WL9300RG	
783008GRG 783008BRG	
Screw Length: 3 in.      Thread Length: 2 in.	

Item No.	
C9300L2M	
Screw Length: 3 in.      Upper Thread Length: 1/2 in.	
Lower Thread Length: 1 1/2 in.      Unthreaded Length: 7/8 in.	

Item No.	
C8300TXG2	
Screw Length: 3 in.      Upper Thread Length: 3/16 in.	
Lower Thread Length: 2 3/16 in.      Unthreaded Length: 3/8 in.	

Item No.	
G10350G G10350GB	
Screw Length: 3 1/2 in.      Thread Length: 1 3/4 in.	

Item No.	
GTST350	
Screw Length: 3 1/2 in.      Thread Length: 2 5/16 in.	

Item No.	
78350RG 78350BRG	
Screw Length: 3 1/2 in.      Thread Length: 2 3/8 in.	

Item No.	
G10400G G10400GB	
Screw Length: 4 in.      Thread Length: 2 in.	

Item No.	
GTST400 78400RG W10400RG 78400BRG	
Screw Length: 4 in.      Thread Length: 2 11/16 in.	

# Thread Length

## Exterior Wood



### Exterior Wood: PS1053 (continued)

Item No.	
G10500G	
G10500GB	
78500BRG	
Screw Length: 5 in.      Thread Length: 2 in.	

Item No.	
78600RG	
Screw Length: 6 in.      Thread Length: 2 in.	

### Exterior Wood: PS1059

Item No.	
U8150G	
Screw Length: 1 1/2 in.      Upper Thread Length: 3/16 in.	
Lower Thread Length: 1 1/16 in.      Unthreaded Length: 1/16 in.	

Item No.	
U9250G	
Screw Length: 2 1/2 in.      Upper Thread Length: 7/16 in.	
Lower Thread Length: 1 5/8 in.      Unthreaded Length: 1/4 in.	

Item No.	
U8200G	
Screw Length: 2 in.      Upper Thread Length: 7/16 in.	
Lower Thread Length: 1 1/4 in.      Unthreaded Length: 1/8 in.	

Item No.	
U10300G	
Screw Length: 3 in.      Upper Thread Length: 7/16 in.	
Lower Thread Length: 1 15/16 in.      Unthreaded Length: 3/8 in.	

# Thread Length

Exterior Wood

**GRABBER**  
CONSTRUCTION PRODUCTS

## Exterior Wood: PS1059 (continued)

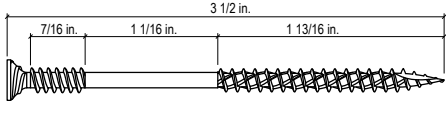
Item No.		
U10350G		
Screw Length: 3 1/2 in.	Upper Thread Length: 7/16 in.	
Lower Thread Length: 1 13/16 in.	Unthreaded Length: 1 1/16 in.	

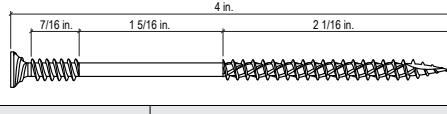
Item No.		
U10400G		
Screw Length: 4 in.	Upper Thread Length: 7/16 in.	
Lower Thread Length: 2 1/16 in.	Unthreaded Length: 1 5/16 in.	

## Exterior Wood: PS1061

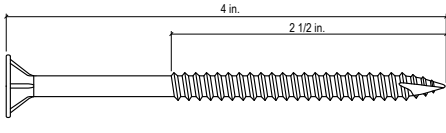
Item No.		
GTIE4		
Screw Length: 4 in.	Thread Length: 2 1/2 in.	

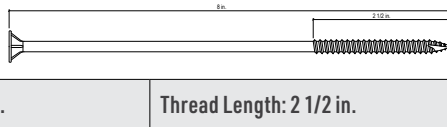
Item No.		
GTIE8		
Screw Length: 8 in.	Thread Length: 2 1/2 in.	

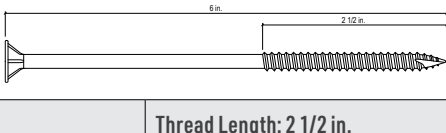
Item No.		
GTIE6		
Screw Length: 6 in.	Thread Length: 2 1/2 in.	

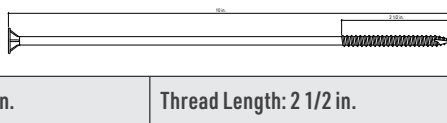
Item No.		
GTIE10		
Screw Length: 10 in.	Thread Length: 2 1/2 in.	

# Thread Length

## Light-Gauge Steel



### Light-Gauge Steel: PS1017

Item No.	
168	
C168	
168Z	
C168Z	
Screw Length: 1 in.	
Thread Length: 13/16 in.	

Item No.	
268	
C268	
268Z	
Screw Length: 1 1/8 in.	
Thread Length: 15/16 in.	

Item No.	
368	
C368	
368YZ	
368Z	
Screw Length: 1 1/4 in.	
Thread Length: 1 1/8 in.	

Item No.	
468	
C468	
468Z	
Screw Length: 1 5/8 in.	
Thread Length: 1 7/16 in.	

Item No.	
568	
C568	
Screw Length: 1 3/4 in.	
Thread Length: 1 9/16 in.	

Item No.	
768	
C768	
768Z	
Screw Length: 2 in.	
Thread Length: 1 13/16 in.	

Item No.	
868	
Screw Length: 2 1/4 in.	
Thread Length: 2 in.	

Item No.	
968	
968Z	
Screw Length: 2 1/2 in.	
Thread Length: 2 in.	

Item No.	
1168	
1168Z	
Screw Length: 3 in.	
Thread Length: 2 in.	

Item No.	
1268	
1268YZ	
Screw Length: 3 1/2 in.	
Thread Length: 2 in.	

Item No.	
1368	
1368YZ	
Screw Length: 4 in.	
Thread Length: 2 in.	

## Thread Length

### Light-Gauge Steel

**GRABBER**  
CONSTRUCTION PRODUCTS

#### Light-Gauge Steel: PS1017 (continued)

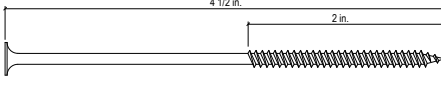
Item No.		
1468		
B10450LYZ		
Screw Length: 4 1/2 in.	Thread Length: 2 in.	

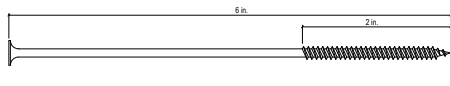
Item No.		
1768		
1768YZ		
Screw Length: 6 in.	Thread Length: 2 in.	

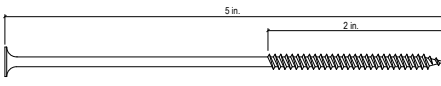
Item No.		
1568		
1568YZ		
Screw Length: 5 in.	Thread Length: 2 in.	

#### Light-Gauge Steel: PS1018

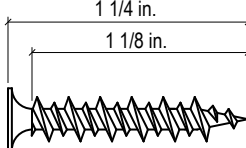
Item No.		
368HL		
Screw Length: 1 1/4 in.	Thread Length: 1 1/8 in.	

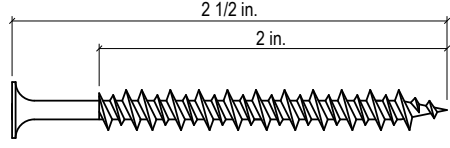
Item No.		
968HL		
Screw Length: 2 1/2 in.	Thread Length: 2 in.	

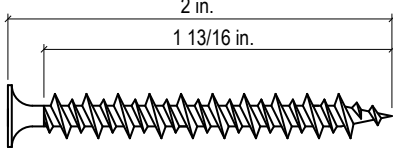
Item No.		
768HL		
Screw Length: 2 in.	Thread Length: 1 13/16 in.	

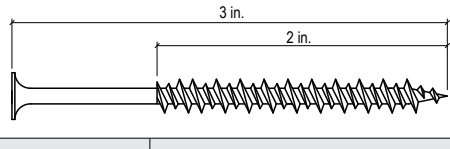
Item No.		
1168HL		
Screw Length: 3 in.	Thread Length: 2 in.	

# Thread Length

## Light-Gauge Steel



### Light-Gauge Steel: PS1021

Item No.		
CS8150L3YZ		
CS8150JBWYZ		
Screw Length: 1 1/2 in.		Thread Length: 1 5/16 in.

Item No.		
CS8200JBWYZ		
Screw Length: 2 in.		Thread Length: 1 13/16 in.

Item No.		
CS8250JBWYZ		
Screw Length: 2 1/2 in.		Thread Length: 2 5/16 in.

Item No.		
GPLY150		
Screw Length: 1 1/2 in.		Upper Thread Length: 11/16 in.
Lower Thread Length: 3/16 in.		Unthreaded Length: 1/2 in.

Item No.		
GPLY200		
Screw Length: 2 in.		Upper Thread Length: 15/16 in.
Lower Thread Length: 3/16 in.		Unthreaded Length: 3/4 in.

Item No.		
GPLY275		
Screw Length: 2 3/4 in.		Upper Thread Length: 1 11/16 in.
Lower Thread Length: 3/16 in.		Unthreaded Length: 3/4 in.

# Thread Length

## Light-Gauge Steel

**GRABBER**  
CONSTRUCTION PRODUCTS

### Light-Gauge Steel: PS1023

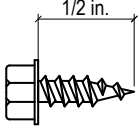
Item No.	
SL03	
Screw Length: 1/2 in.      Thread Length: 1/2 in.	

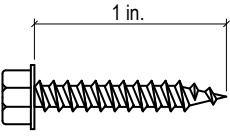
Item No.	
08100HSP	
10100HSP	
25100Z	
Screw Length: 1 in.      Thread Length: 1 in.	

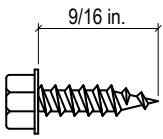
Item No.	
25SZ	
25SLZ	
25Z	
Screw Length: 9/16 in.      Thread Length: 9/16 in.	

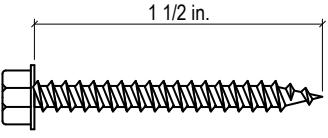
Item No.	
SL14	
25150Z	
Screw Length: 1 1/2 in.      Thread Length: 1 1/2 in.	

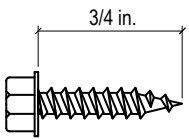
Item No.	
08075HSP	
SL10	
Screw Length: 3/4 in.      Thread Length: 3/4 in.	

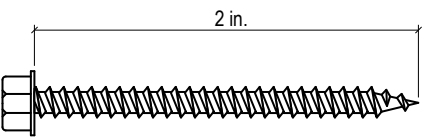
Item No.	
08200HSP	
08200HSPW	
Screw Length: 2 in.      Thread Length: 2 in.	

### Light-Gauge Steel: PS1024

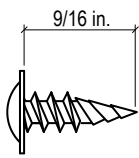
Item No.	
31V	
31ZV	
C31DV	
Screw Length: 9/16 in.      Thread Length: 9/16 in.	

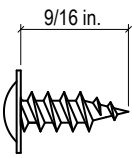
Item No.	
31Z	
Screw Length: 9/16 in.      Thread Length: 9/16 in.	

# Thread Length

## Light-Gauge Steel

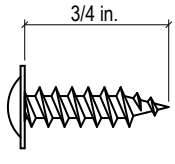

### Light-Gauge Steel: PS1024 (continued)

Item No.	
3119Z	
Screw Length: 3/4 in.	Thread Length: 3/4 in.

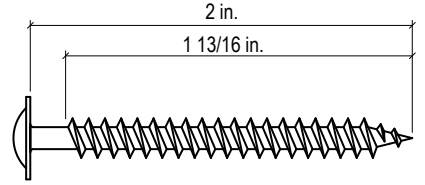
Item No.	
3151Z	
Screw Length: 2 in.	Thread Length: 1 13/16 in.

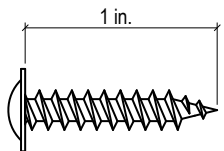
Item No.	
32Z	
Screw Length: 1 in.	Thread Length: 1 in.

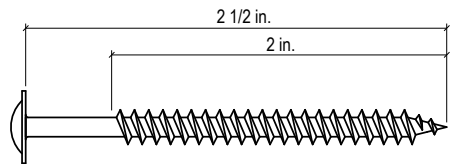
Item No.	
3163Z	
Screw Length: 2 1/2 in.	Thread Length: 2 in.

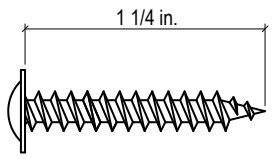
Item No.	
33Z	
Screw Length: 1 1/4 in.	Thread Length: 1 1/4 in.

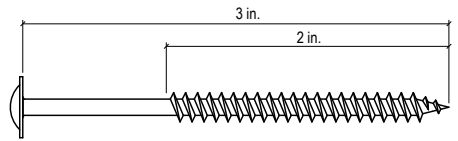
Item No.	
3176Z	
Screw Length: 3 in.	Thread Length: 2 in.

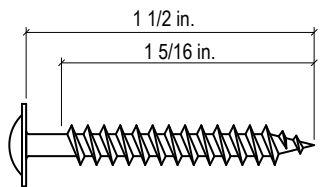
Item No.	
3138Z	
311038Z	
Screw Length: 1 1/2 in.	Thread Length: 1 5/16 in.

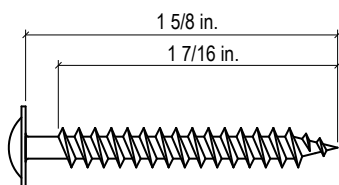
Item No.	
3140Z	
Screw Length: 1 5/8 in.	Thread Length: 1 7/16 in.

# Thread Length

## Light-Gauge Steel

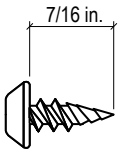

### Light-Gauge Steel: PS1025

Item No.	
23V	
23VZ	
C23V	
Screw Length: 7/16 in.	
Thread Length: 7/16 in.	

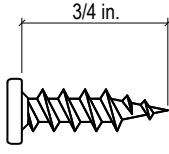
Item No.	
FLP101875SLYZ	
CFLP101875SLYZ	
Screw Length: 3/4 in.	
Thread Length: 3/4 in.	

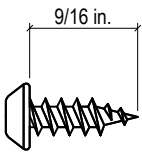
Item No.	
21Z	
Screw Length: 9/16 in.	
Thread Length: 9/16 in.	

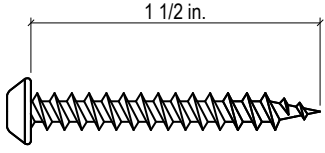
Item No.	
908QZ	
Screw Length: 1 1/2 in.	
Thread Length: 1 1/2 in.	

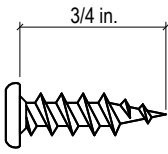
Item No.	
FP101875SLYZ	
CFP101875SLYZ	
Screw Length: 3/4 in.	
Thread Length: 3/4 in.	

### Light-Gauge Steel: PS1027

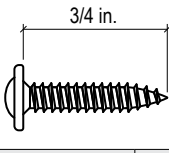
Item No.	
FP101875XSYZ	
CFP101875XSYZ	
Screw Length: 3/4 in.	
Thread Length: 3/4 in.	

### Light-Gauge Steel: PS1029

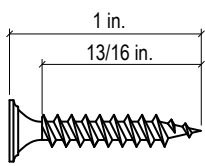
Item No.	
168S	
Screw Length: 1 in.	
Thread Length: 13/16 in.	

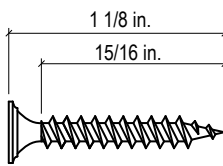
Item No.	
268S	
Screw Length: 1 1/8 in.	
Thread Length: 15/16 in.	

# Thread Length

## Light-Gauge Steel



### Light-Gauge Steel: PS1029 (continued)

Item No.		1 1/4 in.	
368SV		1 1/8 in.	
C368SV			
Screw Length: 1 1/4 in.		Thread Length: 1 1/8 in.	

Item No.		1 5/8 in.	
468S		1 7/16 in.	
Screw Length: 1 5/8 in.		Thread Length: 1 7/16 in.	

Item No.		1 1/4 in.	
368S		1 1/8 in.	
Screw Length: 1 1/4 in.		Thread Length: 1 1/8 in.	

### Light-Gauge Steel: PS1030

Item No.		1 in.	
168SHL		13/16 in.	
Screw Length: 1 in.		Thread Length: 13/16 in.	

Item No.		1 5/8 in.	
468SHL		1 7/16 in.	
C468SHL			
Screw Length: 1 5/8 in.		Thread Length: 1 7/16 in.	

Item No.		1 1/8 in.	
268SHL		15/16 in.	
Screw Length: 1 1/8 in.		Thread Length: 15/16 in.	

Item No.		2 in.	
768SHL		1 13/16 in.	
Screw Length: 2 in.		Thread Length: 1 13/16 in.	

Item No.		1 1/4 in.	
368SHL		1 1/8 in.	
C368SHL			
Screw Length: 1 1/4 in.		Thread Length: 1 1/8 in.	

Item No.		2 1/4 in.	
868SHL		2 in.	
Screw Length: 2 1/4 in.		Thread Length: 2 in.	

## Thread Length

### Light-Gauge Steel

**GRABBER**  
CONSTRUCTION PRODUCTS

#### Light-Gauge Steel: PS1030 (continued)

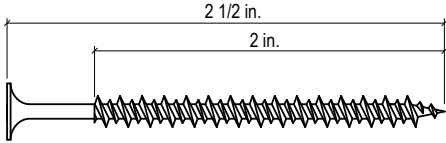
Item No.		
968SHL		
Screw Length: 2 1/2 in.	Thread Length: 2 in.	

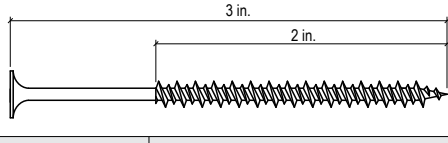
Item No.		
1168SHL		
Screw Length: 3 in.	Thread Length: 2 in.	

#### Light-Gauge Steel: PS1033

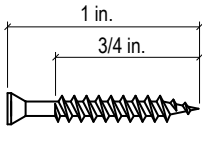
Item No.		
17S100		
Screw Length: 1 in.	Thread Length: 3/4 in.	

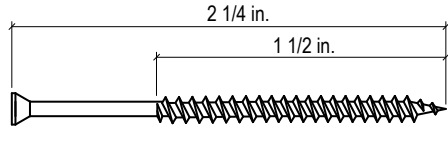
Item No.		
18S		
Screw Length: 2 1/4 in.	Thread Length: 1 1/2 in.	

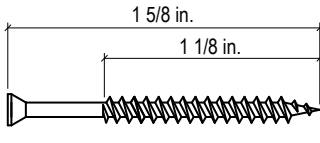
Item No.		
17S		
Screw Length: 1 5/8 in.	Thread Length: 1 1/8 in.	

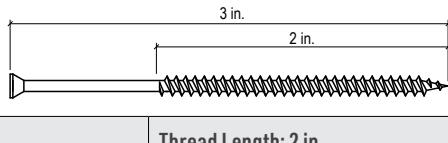
Item No.		
17S76		
Screw Length: 3 in.	Thread Length: 2 in.	

#### Light-Gauge Steel: PS1034

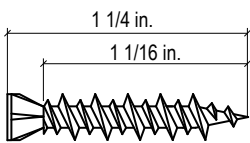
Item No.		
C7125UL2		
Screw Length: 1 1/4 in.	Thread Length: 1 1/16 in.	

#### Light-Gauge Steel: PS1035

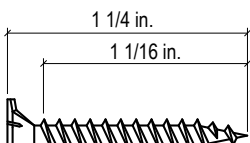
Item No.		
GHS8114LG		
CGHS8114LG		
Screw Length: 1 1/4 in.	Thread Length: 1 1/16 in.	

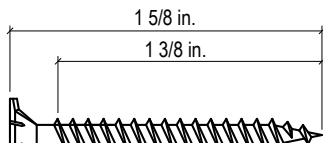
Item No.		
GHS8158LG		
CGHS8158LG		
Screw Length: 1 5/8 in.	Thread Length: 1 3/8 in.	

## Thread Length

### Light-Gauge Steel

#### Light-Gauge Steel: PS1035 (continued)

Item No.		
CGHS8238LG		
Screw Length: 2 3/8 in.	Thread Length: 2 3/16 in.	

#### Light-Gauge Steel: PS1036

Item No.		
GCB8125HL		
Screw Length: 1 1/4 in.	Thread Length: 1 1/8 in.	

Item No.		
GCB8238HL		
Screw Length: 2 3/8 in.	Thread Length: 2 1/4 in.	

Item No.		
GCB8158HL		
Screw Length: 1 5/8 in.	Thread Length: 1 1/2 in.	

Item No.		
GCB10350HL		
Screw Length: 3 1/2 in.	Thread Length: 2 in.	

#### Light-Gauge Steel: PS1038

Item No.		
H-3		
Screw Length: 2 3/4 in.	Thread Length: 1 1/2 in.	

# Thread Length

## Light-Gauge Steel



### Light-Gauge Steel: PS1052

<b>Item No.</b>	
268RG	
Screw Length: 1 1/8 in.	Thread Length: 15/16 in.

<b>Item No.</b>	
468RG	
Screw Length: 1 5/8 in.	Thread Length: 1 7/16 in.

<b>Item No.</b>	
368RG	
C368RG	
Screw Length: 1 1/4 in.	Thread Length: 1 1/8 in.

### Light-Gauge Steel: PS1055

<b>Item No.</b>	
CS8150LRG	
Screw Length: 1 1/2 in.	Thread Length: 1 5/16 in.

<b>Item No.</b>	
CS8175LRG	
Screw Length: 1 3/4 in.	Thread Length: 1 9/16 in.

### Light-Gauge Steel: PS1056

<b>Item No.</b>	
31RG	
Screw Length: 9/16 in.	Thread Length: 9/16 in.

<b>Item No.</b>	
33RG	
Screw Length: 1 1/4 in.	Thread Length: 1 1/4 in.

<b>Item No.</b>	
32RG	
Screw Length: 1 in.	Thread Length: 1 in.

<b>Item No.</b>	
3138RG	
Screw Length: 1 1/2 in.	Thread Length: 1 5/16 in.

# Thread Length

## Light-Gauge Steel

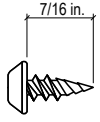

### Light-Gauge Steel: PS1057

<b>Item No.</b>	
23VRG	
Screw Length: 7/16 in.	Thread Length: 7/16 in.

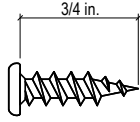
<b>Item No.</b>	
FP101875PSG	
Screw Length: 3/4 in.	Thread Length: 3/4 in.

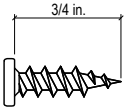
<b>Item No.</b>	
FLP101875SLRG	
Screw Length: 3/4 in.	Thread Length: 3/4 in.

### Light-Gauge Steel: PS1058

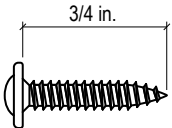
<b>Item No.</b>	
FP101875PSG	
Screw Length: 3/4 in.	Thread Length: 3/4 in.

### Light-Gauge Steel: PS1060

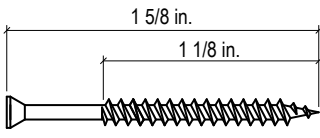
<b>Item No.</b>	
17SSQ	
Screw Length: 1 5/8 in.	Thread Length: 1 1/8 in.

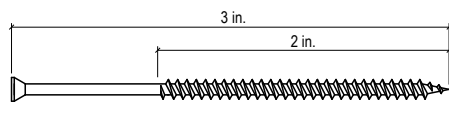
<b>Item No.</b>	
17S76RG	
Screw Length: 3 in.	Thread Length: 2 in.

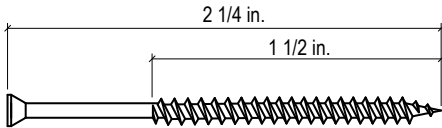
<b>Item No.</b>	
18SRG	
Screw Length: 2 1/4 in.	Thread Length: 1 1/2 in.

# Thread Length

## Heavy-Gauge Steel

**GRABBER**  
CONSTRUCTION PRODUCTS

### Heavy-Gauge Steel: PS1002

Item No.	Drill Point	
14Z8LOX	#3	
C14Z8LOX	#3	
C14Z	#3	
Screw Length: 1 1/4 in.		
Thread Length: 7/8 in.		
Drill Point Length: 3/16 in.		

Item No.	Drill Point	
30SZL2	#3	
C30SZ	#3	
C30SZL2	#3	
Screw Length: 2 3/8 in.		
Thread Length: 2 in.		
Drill Point Length: 3/16 in.		

Item No.	Drill Point	
C15Z	#3	
Screw Length: 1 5/8 in.		
Thread Length: 1 1/4 in.		
Drill Point Length: 3/16 in.		

Item No.	Drill Point	
C30MZL2	#3	
Screw Length: 2 5/8 in.		
Thread Length: 2 1/4 in.		
Drill Point Length: 3/16 in.		

Item No.	Drill Point	
C16	#3	
C16Z	#3	
Screw Length: 1 7/8 in.		
Thread Length: 1 1/2 in.		
Drill Point Length: 3/16 in.		

Item No.	Drill Point	
30LZL2	#3	
Screw Length: 3 in.		
Thread Length: 2 5/8 in.		
Drill Point Length: 3/16 in.		

Item No.	Drill Point	
B10350SDZ	#3	
B10350SDL2Z	#3	
Screw Length: 3 1/2 in.		
Thread Length: 1 13/16 in.		
Drill Point Length: 3/16 in.		

# Thread Length

## Heavy-Gauge Steel



### Heavy-Gauge Steel: PS1002 (continued)

Item No.	Drill Point	
B10400SDZ	#3	
B10400SDL2Z	#3	
Screw Length: 4 in.		
Thread Length: 1 13/16 in.		
Drill Point Length: 3/16 in.		

Item No.	Drill Point	
B10500SDZ	#3	
Screw Length: 5 in.		
Thread Length: 1 13/16 in.		
Drill Point Length: 3/16 in.		

### Heavy-Gauge Steel: PS1005

Item No.	Drill Point	
834FZ3	#3	
Screw Length: 3/4 in.		
Thread Length: 9/16 in.		
Drill Point Length: 3/16 in.		

Item No.	Drill Point	
LW2158LYZ	#3	
Screw Length: 1 5/8 in.		
Thread Length: 1 7/16 in.		
Drill Point Length: 3/16 in.		

# Thread Length

## Heavy-Gauge Steel



### Heavy-Gauge Steel: PS1006

Item No.	Drill Point	
P8516F3	#3	
Screw Length: 1 5/16 in.		
Thread Length: 1/2 in.		
Drill Point Length: 3/16 in.		

Item No.	Drill Point	
12200FW4	#4	
Screw Length: 2 in.		
Thread Length: 1 in.		
Drill Point Length: 7/16 in.		

Item No.	Drill Point	
M175SDZJBW	#3.5	
CM175SDZJBW	#3.5	
Screw Length: 1 3/4 in.		
Thread Length: 15/16 in.		
Drill Point Length: 1/4 in.		

Item No.	Drill Point	
12200FW3	#3	
Screw Length: 2 in.		
Thread Length: 1 1/4 in.		
Drill Point Length: 1/4 in.		

Item No.	Drill Point	
M10178SDZJBW	#3.5	
CM10178SDZJBW	#3.5	
Screw Length: 1 7/8 in.		
Thread Length: 15/16 in.		
Drill Point Length: 3/8 in.		

Item No.	Drill Point	
12250FW3	#3	
12250F3	#3	
Screw Length: 2 1/2 in.		
Thread Length: 1 3/4 in.		
Drill Point Length: 1/4 in.		

Item No.	Drill Point	
P81516F3	#3	
Screw Length: 1 15/16 in.		
Thread Length: 1 1/16 in.		
Drill Point Length: 3/16 in.		

# Thread Length

## Heavy-Gauge Steel



### Heavy-Gauge Steel: PS1006 (continued)

Item No.	Drill Point	
12275FW4	#4	
Screw Length: 2 3/4 in.		
Thread Length: 1 3/4 in.		
Drill Point Length: 7/16 in.		

Item No.	Drill Point	
12275FW3	#3	
Screw Length: 2 3/4 in.		
Thread Length: 2 in.		
Drill Point Length: 1/4 in.		

Item No.	Drill Point	
14275FW3	#3	
Screw Length: 2 3/4 in.		
Thread Length: 2 in.		
Drill Point Length: 5/16 in.		

### Heavy-Gauge Steel: PS1007

Item No.	Drill Point	
C10150L3YZH	#3	
Screw Length: 1 1/2 in.		
Thread Length: 15/16 in.		
Drill Point Length: 5/16 in.		

Item No.	Drill Point	
10200L3YZE	#3.5	
C10200L3YZE	#3.5	
Screw Length: 2 in.		
Thread Length: 1 1/4 in.		
Drill Point Length: 5/16 in.		

Item No.	Drill Point	
C10175L3YZE	#3.5	
Screw Length: 1 3/4 in.		
Thread Length: 1 in.		
Drill Point Length: 5/16 in.		

Item No.	Drill Point	
C10250L3YZE	#3.5	
Screw Length: 2 1/2 in.		
Thread Length: 1 3/4 in.		
Drill Point Length: 5/16 in.		

# Thread Length

## Heavy-Gauge Steel



### Heavy-Gauge Steel: PS1008

Item No.	Drill Point	
10050H3	#3	
H10050H3	#3	
08050H3	#3	
Screw Length: 1/2 in.		
Thread Length: 5/16 in.		
Drill Point Length: 3/16 in.		

Item No.	Drill Point	
122478H4	#4	
H122478H4	#4	
Screw Length: 7/8 in.		
Thread Length: 7/16 in.		
Drill Point Length: 7/16 in.		

Item No.	Drill Point	
10058H3	#3	
08058H3	#3	
Screw Length: 5/8 in.		
Thread Length: 7/16 in.		
Drill Point Length: 3/16 in.		

Item No.	Drill Point	
14100H3	#3	
12100H3	#3	
H12100H3	#3	
Screw Length: 1 in.		
Thread Length: 11/16 in.		
Drill Point Length: 5/16 in.		

Item No.	Drill Point	
14075H3	#3	
12075H3	#3	
H12075H3	#3	
Screw Length: 3/4 in.		
Thread Length: 7/16 in.		
Drill Point Length: 5/16 in.		

Item No.	Drill Point	
10100H3	#3	
H10100H3	#3	
08100H3	#3	
H08100H3	#3	
Screw Length: 1 in.		
Thread Length: 13/16 in.		
Drill Point Length: 3/16 in.		

Item No.	Drill Point	
10075H3	#3	
H10075H3	#3	
08075H3	#3	
Screw Length: 3/4 in.		
Thread Length: 9/16 in.		
Drill Point Length: 3/16 in.		

Item No.	Drill Point	
1224125H5	#5	
Screw Length: 1 1/4 in.		
Thread Length: 5/8 in.		
Drill Point Length: 5/8 in.		

Item No.	Drill Point	
10075H35	#3.5	
Screw Length: 3/4 in.		
Thread Length: 3/8 in.		
Drill Point Length: 3/8 in.		

Item No.	Drill Point	
1224125H5SL	#5	
Screw Length: 1 1/4 in.		
Thread Length: 5/8 in.		
Drill Point Length: 5/8 in.		

# Thread Length

## Heavy-Gauge Steel



### Heavy-Gauge Steel: PS1008 (continued)

Item No.	Drill Point
1224125H4	#4
H1224125H4	#4
Screw Length: 1 1/4 in.	
Thread Length: 13/16 in.	
Drill Point Length: 7/16 in.	

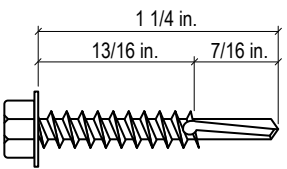

Item No.	Drill Point
14150H3	#3
12150H3	#3
H12150H3	#3
Screw Length: 1 1/2 in.	
Thread Length: 1 3/16 in.	
Drill Point Length: 5/16 in.	

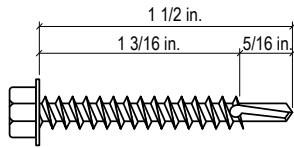

Item No.	Drill Point
14125H3	#3
12125H3	#3
H12125H3	#3
Screw Length: 1 1/4 in.	
Thread Length: 15/16 in.	
Drill Point Length: 5/16 in.	

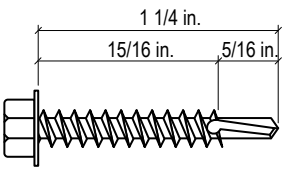

Item No.	Drill Point
10150H3	#3
H10150H3	#3
Screw Length: 1 1/2 in.	
Thread Length: 1 5/16 in.	
Drill Point Length: 3/16 in.	

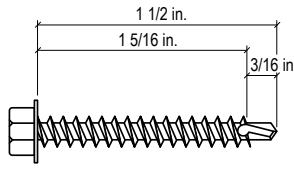

Item No.	Drill Point
10125H3	#3
H10125H3	#3
08125H3	#3
Screw Length: 1 1/4 in.	
Thread Length: 1 1/16 in.	
Drill Point Length: 3/16 in.	

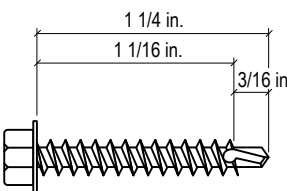

Item No.	Drill Point
1224200H5SL	#5
Screw Length: 2 in.	
Thread Length: 1 3/8 in.	
Drill Point Length: 5/8 in.	

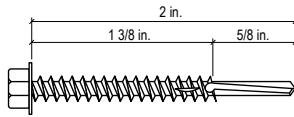

Item No.	Drill Point
1224150H5SL	#5
Screw Length: 1 1/2 in.	
Thread Length: 7/8 in.	
Drill Point Length: 5/8 in.	

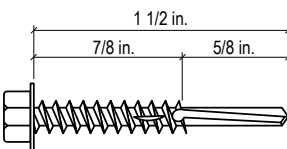

Item No.	Drill Point
1224200H4	#4
Screw Length: 2 in.	
Thread Length: 1 9/16 in.	
Drill Point Length: 7/16 in.	

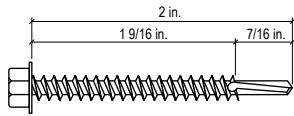

Item No.	Drill Point
H1224150H4	#4
Screw Length: 1 1/2 in.	
Thread Length: 1 1/16 in.	
Drill Point Length: 7/16 in.	

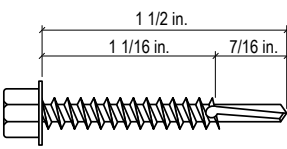

# Thread Length

## Heavy-Gauge Steel

**GRABBER**  
CONSTRUCTION PRODUCTS

### Heavy-Gauge Steel: PS1008 (continued)

Item No.	Drill Point	
14200H3	#3	
12200H3	#3	
H12200H3	#3	
Screw Length: 2 in.		
Thread Length: 1 11/16 in.		
Drill Point Length: 5/16 in.		

Item No.	Drill Point	
10200H3	#3	
H10200H3	#3	
08200H3	#3	
Screw Length: 2 in.		
Thread Length: 1 13/16 in.		
Drill Point Length: 3/16 in.		

Item No.	Drill Point	
14250H3	#3	
12250H3	#3	
H12250H3	#3	
Screw Length: 2 1/2 in.		
Thread Length: 2 3/16 in.		
Drill Point Length: 5/16 in.		

Item No.	Drill Point	
14300H3	#3	
H12300H3	#3	
12300H3	#3	
Screw Length: 3 in.		
Thread Length: 2 11/16 in.		
Drill Point Length: 5/16 in.		

Item No.	Drill Point	
12350H3	#3	
Screw Length: 3 1/2 in.		
Thread Length: 3 3/16 in.		
Drill Point Length: 5/16 in.		

Item No.	Drill Point	
14400H4	#4	
Screw Length: 4 in.		
Thread Length: 3 9/16 in.		
Drill Point Length: 7/16 in.		

# Thread Length

## Heavy-Gauge Steel



### Heavy-Gauge Steel: PS1009

Item No.	Drill Point	
34Z	#3	
C34DZ	#3	
234Z	#3	
Screw Length: 1/2 in.		
Thread Length: 5/16 in.		
Drill Point Length: 3/16 in.		

Item No.	Drill Point	
234Z12CW	#3	
Screw Length: 3/4 in.		
Thread Length: 7/16 in.		
Drill Point Length: 5/16 in.		

Item No.	Drill Point	
234Z10CW	#3	
C234DZ10	#3	
Screw Length: 3/4 in.		
Thread Length: 9/16 in.		
Drill Point Length: 3/16 in.		

Item No.	Drill Point	
35Z	#3	
235Z	#3	
Screw Length: 1 in.		
Thread Length: 13/16 in.		
Drill Point Length: 3/16 in.		

Item No.	Drill Point	
36Z	#3	
236Z	#3	
236Z10CW	#3	
Screw Length: 1 1/4 in.		
Thread Length: 1 1/16 in.		
Drill Point Length: 3/16 in.		

Item No.	Drill Point	
37Z10CW	#3	
Screw Length: 1 1/2 in.		
Thread Length: 1 5/16 in.		
Drill Point Length: 3/16 in.		

Item No.	Drill Point	
37Z	#3	
237Z	#3	
Screw Length: 1 5/8 in.		
Thread Length: 1 7/16 in.		
Drill Point Length: 3/16 in.		

Item No.	Drill Point	
376Z	#3	
Screw Length: 2 in.		
Thread Length: 1 13/16 in.		
Drill Point Length: 3/16 in.		

Item No.	Drill Point	
238Z	#3	
Screw Length: 2 1/2 in.		
Thread Length: 1 7/16 in.		
Drill Point Length: 3/16 in.		

# Thread Length

## Heavy-Gauge Steel



### Heavy-Gauge Steel: PS1009 (continued)

Item No.	Drill Point	
39Z	#3	
Screw Length: 3 in.		
Thread Length: 1 7/16 in.		
Drill Point Length: 3/16 in.		

Item No.	Drill Point	
241Z	#3	
Screw Length: 4 in.		
Thread Length: 1 13/16 in.		
Drill Point Length: 3/16 in.		

Item No.	Drill Point	
240Z	#3	
Screw Length: 3 1/2 in.		
Thread Length: 1 13/16 in.		
Drill Point Length: 3/16 in.		

Item No.	Drill Point	
242Z	#3	
Screw Length: 5 in.		
Thread Length: 1 13/16 in.		
Drill Point Length: 3/16 in.		

### Heavy-Gauge Steel: PS1010

Item No.	Drill Point	
19	#3	
19Z	#3	
Screw Length: 7/16 in.		
Thread Length: 5/16 in.		
Drill Point Length: 1/8 in.		

Item No.	Drill Point	
1058FP	#3	
Screw Length: 5/8 in.		
Thread Length: 7/16 in.		
Drill Point Length: 3/16 in.		

Item No.	Drill Point	
20Z	#3	
Screw Length: 1/2 in.		
Thread Length: 5/16 in.		
Drill Point Length: 3/16 in.		

Item No.	Drill Point	
CFP101858JBWZ	#3	
Screw Length: 5/8 in.		
Thread Length: 3/8 in.		
Drill Point Length: 1/4 in.		

Item No.	Drill Point	
10058P3	#3	
Screw Length: 5/8 in.		
Thread Length: 7/16 in.		
Drill Point Length: 3/16 in.		

Item No.	Drill Point	
FP102275LYZ	#3.5	
CFP102275LYZ	#3.5	
Screw Length: 3/4 in.		
Thread Length: 3/8 in.		
Drill Point Length: 3/8 in.		

# Thread Length

## Heavy-Gauge Steel



### Heavy-Gauge Steel: PS1010 (continued)

Item No.	Drill Point
CFP101875JBWZ	#3
CFP101875LYZ	#3
CFP101875LYZ3	#3
CFP121875L2Z	#3.5
CFP121875LYZ	#3.5
FP101875JBWZ	#3
FP101875LYZ	#3
FP101875LYZ3	#3
Screw Length: 3/4 in.	
Thread Length: 1/2 in.	
Drill Point Length: 1/4 in.	

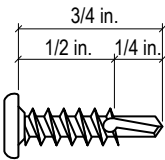

Item No.	Drill Point
FP121878JBWZ	#3.5
CFP121878JBWZ	#3.5
CFP121878LYZ	#3.5
Screw Length: 7/8 in.	
Thread Length: 5/8 in.	
Drill Point Length: 1/4 in.	

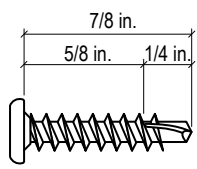

Item No.	Drill Point
10075P3	#3
Screw Length: 3/4 in.	
Thread Length: 9/16 in.	
Drill Point Length: 3/16 in.	

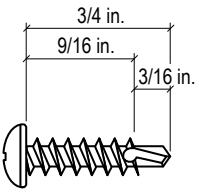

Item No.	Drill Point
CCFP12158LYZ	#5
Screw Length: 1 5/8 in.	
Thread Length: 1 in.	
Drill Point Length: 5/8 in.	

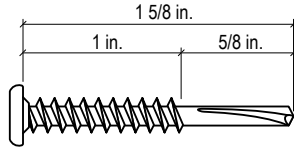

### Heavy-Gauge Steel: PS1011

Item No.	Drill Point
DMWH138	#3
CDMWH138	#3
Screw Length: 1 3/8 in.	
Thread Length: 1 3/16 in.	
Drill Point Length: 3/16 in.	

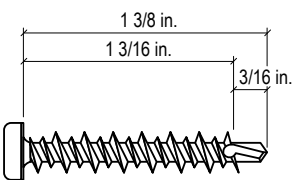

# Thread Length

## Heavy-Gauge Steel



### Heavy-Gauge Steel: PS1013

Item No.	Drill Point	
13S	#3	
13SZ	#3	
Screw Length: 1 in.		
Thread Length: 5/8 in.		
Drill Point Length: 1/8 in.		

Item No.	Drill Point	
16S	#3	
16SZ	#3	
Screw Length: 1 7/8 in.		
Thread Length: 1 1/2 in.		
Drill Point Length: 1/8 in.		

Item No.	Drill Point	
135S	#3	
135SZ	#3	
Screw Length: 1 1/8 in.		
Thread Length: 3/4 in.		
Drill Point Length: 1/8 in.		

Item No.	Drill Point	
30SS	#3	
30SSZ	#3	
Screw Length: 2 3/8 in.		
Thread Length: 1 7/16 in.		
Drill Point Length: 3/16 in.		

Item No.	Drill Point	
14SZ8	#3	
Screw Length: 1 1/4 in.		
Thread Length: 7/8 in.		
Drill Point Length: 3/16 in.		

Item No.	Drill Point	
30MS	#3	
30MSZ	#3	
Screw Length: 2 5/8 in.		
Thread Length: 1 7/16 in.		
Drill Point Length: 3/16 in.		

Item No.	Drill Point	
14S	#3	
14SZ	#3	
C14S	#3	
Screw Length: 1 1/4 in.		
Thread Length: 7/8 in.		
Drill Point Length: 1/8 in.		

Item No.	Drill Point	
30LS	#3	
30LSZ	#3	
Screw Length: 3 in.		
Thread Length: 1 11/16 in.		
Drill Point Length: 3/16 in.		

Item No.	Drill Point	
15S	#3	
15SZ	#3	
Screw Length: 1 5/8 in.		
Thread Length: 1 1/4 in.		
Drill Point Length: 1/8 in.		

# Thread Length

## Heavy-Gauge Steel



### Heavy-Gauge Steel: PS1014

Item No.	Drill Point	
17SD	#3	
17SDZ	#3	
Screw Length: 1 5/8 in.		
Thread Length: 15/16 in.		
Drill Point Length: 3/16 in.		

Item No.	Drill Point	
17SD76	#3	
17SD76Z	#3	
Screw Length: 3 in.		
Thread Length: 1 11/16 in.		
Drill Point Length: 3/16 in.		

Item No.	Drill Point	
18SD	#3	
18SDZ	#3	
Screw Length: 2 1/4 in.		
Thread Length: 1 5/16 in.		
Drill Point Length: 3/16 in.		

### Heavy-Gauge Steel: PS1015

Item No.	Drill Point	
GH8114LG	#3	
CGH8114LG	#3	
Screw Length: 1 1/4 in.		
Thread Length: 11/16 in.		
Drill Point Length: 5/16 in.		

Item No.	Drill Point	
GH8158LG	#3	
CGH8158LG	#3	
Screw Length: 1 5/8 in.		
Thread Length: 1 1/16 in.		
Drill Point Length: 5/16 in.		

Item No.	Drill Point	
GCB8125SD	#3	
Screw Length: 1 1/4 in.		
Thread Length: 15/16 in.		
Drill Point Length: 3/16 in.		

Item No.	Drill Point	
GCB8158SD	#3	
Screw Length: 1 5/8 in.		
Thread Length: 1 5/16 in.		
Drill Point Length: 3/16 in.		

## Thread Length

### Heavy-Gauge Steel

**GRABBER**  
CONSTRUCTION PRODUCTS

### Heavy-Gauge Steel: PS1015 (continued)

Item No.	Drill Point	
GH8238LG	#3	
CGH8238LG	#3	
Screw Length: 2 3/8 in.		
Thread Length: 1 13/16 in.		
Drill Point Length: 5/16 in.		

Item No.	Drill Point	
GCB10350SD	#3	
Screw Length: 3 1/2 in.		
Thread Length: 2 in.		
Drill Point Length: 3/16 in.		

Item No.	Drill Point	
GCB8238SD	#3	
Screw Length: 2 3/8 in.		
Thread Length: 2 1/16 in.		
Drill Point Length: 3/16 in.		

### Heavy-Gauge Steel: PS1039

Item No.	Drill Point	
H-1	#3	
Screw Length: 3 1/4 in.		
Thread Length: 1 3/4 in.		
Drill Point Length: 1/4 in.		

Item No.	Drill Point	
H-2	#3	
H-5	#3	
JS1	#3	
Screw Length: 2 in.		
Thread Length: 1/2 in.		
Drill Point Length: 1/4 in.		

# Thread Length

## Heavy-Gauge Steel



### Heavy-Gauge Steel: PS1040

Item No.	Drill Point	
14RG8F	#3	
C14RG8F	#3	
14RG	#3	
C14RG	#3	
Screw Length: 1 1/4 in.		
Thread Length: 7/8 in.		
Drill Point Length: 3/16 in.		

Item No.	Drill Point	
C15GG8P	#3	
Screw Length: 1 5/8 in.		
Thread Length: 15/16 in.		
Drill Point Length: 3/16 in.		

Item No.	Drill Point	
15RG	#3	
Screw Length: 1 5/8 in.		
Thread Length: 1 1/4 in.		
Drill Point Length: 3/16 in.		

Item No.	Drill Point	
16RG8F	#3	
16RG	#3	
C16RG	#3	
Screw Length: 1 7/8 in.		
Thread Length: 1 1/2 in.		
Drill Point Length: 3/16 in.		

Item No.	Drill Point	
30SRG	#3	
Screw Length: 2 3/8 in.		
Thread Length: 1 3/8 in.		
Drill Point Length: 3/16 in.		

Item No.	Drill Point	
30MRG	#3	
Screw Length: 2 5/8 in.		
Thread Length: 1 3/8 in.		
Drill Point Length: 3/16 in.		

Item No.	Drill Point	
30LRG	#3	
Screw Length: 3 in.		
Thread Length: 1 11/16 in.		
Drill Point Length: 3/16 in.		

Item No.	Drill Point	
B10350SDRG	#3	
Screw Length: 3 1/2 in.		
Thread Length: 1 13/16 in.		
Drill Point Length: 3/16 in.		

Item No.	Drill Point	
B10400SDRG	#3	
Screw Length: 4 in.		
Thread Length: 1 13/16 in.		
Drill Point Length: 3/16 in.		

# Thread Length

## Heavy-Gauge Steel

**GRABBER**  
CONSTRUCTION PRODUCTS

### Heavy-Gauge Steel: PS1040 (continued)

Item No.	Drill Point	
B10500SDRG	#3	
Screw Length: 5 in.		
Thread Length: 1 13/16 in.		
Drill Point Length: 3/16 in.		

### Heavy-Gauge Steel: PS1041

Item No.	Drill Point	
CMG158SD	#3	
Screw Length: 1 5/8 in.		
Thread Length: 1 in.		
Drill Point Length: 3/16 in.		

Item No.	Drill Point	
CC12250LRG	#3	
Screw Length: 2 1/2 in.		
Thread Length: 1 3/4 in.		
Drill Point Length: 5/8 in.		

Item No.	Drill Point	
CM10178JBWRG	#3.5	
Screw Length: 1 7/8 in.		
Thread Length: 15/16 in.		
Drill Point Length: 3/8 in.		

Item No.	Drill Point	
12250FW3RG	#3	
Screw Length: 2 1/2 in.		
Thread Length: 1 3/4 in.		
Drill Point Length: 1/4 in.		

Item No.	Drill Point	
12200FW3RG	#3	
Screw Length: 2 in.		
Thread Length: 1 1/4 in.		
Drill Point Length: 1/4 in.		

Item No.	Drill Point	
12250F3RG	#3	
Screw Length: 2 1/2 in.		
Thread Length: 1 3/4 in.		
Drill Point Length: 1/4 in.		

Item No.	Drill Point	
MG238SD	#3	
Screw Length: 2 3/8 in.		
Thread Length: 1 5/8 in.		
Drill Point Length: 3/16 in.		

Item No.	Drill Point	
12275FW3RG	#3	
Screw Length: 2 3/4 in.		
Thread Length: 2 1/16 in.		
Drill Point Length: 1/4 in.		

**Thread Length**  
Heavy-Gauge Steel

Heavy-Gauge Steel: PS1041 (continued)

Item No.	Drill Point	
14300FW4RG	#4	
Screw Length: 3 in.		
Thread Length: 2 in.		
Drill Point Length: 7/16 in.		

Item No.	Drill Point	
14350FW4RG	#4	
Screw Length: 3 1/2 in.		
Thread Length: 2 1/2 in.		
Drill Point Length: 7/16 in.		

Item No.	Drill Point	
14325FW4RG	#4	
Screw Length: 3 1/4 in.		
Thread Length: 2 1/4 in.		
Drill Point Length: 7/16 in.		

Item No.	Drill Point	
14375FW4RG	#4	
Screw Length: 3 3/4 in.		
Thread Length: 2 3/4 in.		
Drill Point Length: 7/16 in.		

Heavy-Gauge Steel: PS1042

Item No.	Drill Point	
C10200L3GE	#3.5	
Screw Length: 2 in.		
Thread Length: 1 1/4 in.		
Drill Point Length: 5/16 in.		

## Thread Length

### Heavy-Gauge Steel

**GRABBER**  
CONSTRUCTION PRODUCTS

### Heavy-Gauge Steel: PS1043

Item No.	Drill Point
08050H3SS	#3
Screw Length: 1/2 in.	
Thread Length: 5/16 in.	
Drill Point Length: 3/16 in.	

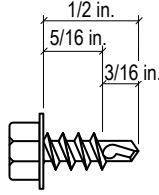

Item No.	Drill Point
10100H3SS	#3
08100H3SS	#3
Screw Length: 1 in.	
Thread Length: 13/16 in.	
Drill Point Length: 3/16 in.	

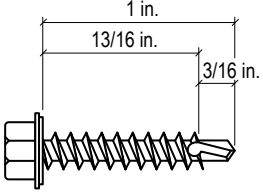

Item No.	Drill Point
12075H3SS	#3
12075H3RG	#3
Screw Length: 3/4 in.	
Thread Length: 7/16 in.	
Drill Point Length: 5/16 in.	

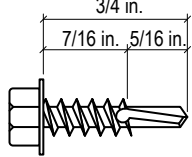

Item No.	Drill Point
1224125H5RG	#5
Screw Length: 1 1/4 in.	
Thread Length: 5/8 in.	
Drill Point Length: 5/8 in.	

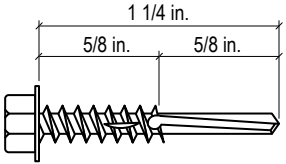

Item No.	Drill Point
10075H3SS	#3
10075H3RG	#3
08075H3SS	#3
Screw Length: 3/4 in.	
Thread Length: 9/16 in.	
Drill Point Length: 3/16 in.	

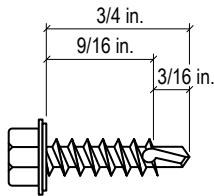

Item No.	Drill Point
1420150H5RG	#5
Screw Length: 1 1/2 in.	
Thread Length: 7/8 in.	
Drill Point Length: 5/8 in.	

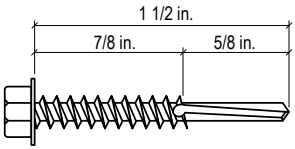

Item No.	Drill Point
14100H3SS	#3
14100H3WRG	#3
Screw Length: 1 in.	
Thread Length: 11/16 in.	
Drill Point Length: 5/16 in.	

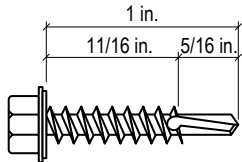

# Thread Length

## Heavy-Gauge Steel



### Heavy-Gauge Steel: PS1043 (continued)

Item No.	Drill Point	
12150H3RG	#3	
Screw Length: 1 1/2 in.		
Thread Length: 1 3/16 in.		
Drill Point Length: 5/16 in.		

Item No.	Drill Point	
1224250H5RG	#5	
Screw Length: 2 1/2 in.		
Thread Length: 1 7/8 in.		
Drill Point Length: 5/8 in.		

Item No.	Drill Point	
10150H3SS	#3	
Screw Length: 1 1/2 in.		
Thread Length: 1 5/16 in.		
Drill Point Length: 3/16 in.		

Item No.	Drill Point	
14300H3SS	#3	
Screw Length: 3 in.		
Thread Length: 2 11/16 in.		
Drill Point Length: 5/16 in.		

Item No.	Drill Point	
10200H3SS	#3	
Screw Length: 2 in.		
Thread Length: 1 13/16 in.		
Drill Point Length: 3/16 in.		

# Thread Length

## Heavy-Gauge Steel

**GRABBER**  
CONSTRUCTION PRODUCTS

### Heavy-Gauge Steel: PS1044

Item No.	Drill Point
34RG	#3
234RG	#3
Screw Length: 1/2 in.	
Thread Length: 5/16 in.	
Drill Point Length: 3/16 in.	

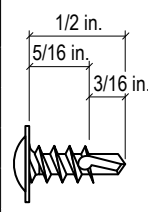

Item No.	Drill Point
23412CWRG	#3
Screw Length: 3/4 in.	
Thread Length: 7/16 in.	
Drill Point Length: 5/16 in.	

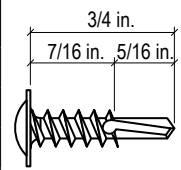

Item No.	Drill Point
23410CWRG	#3
Screw Length: 3/4 in.	
Thread Length: 9/16 in.	
Drill Point Length: 3/16 in.	

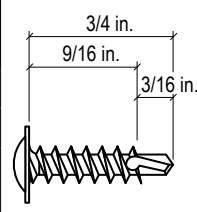

Item No.	Drill Point
35RG	#3
Screw Length: 1 in.	
Thread Length: 13/16 in.	
Drill Point Length: 3/16 in.	

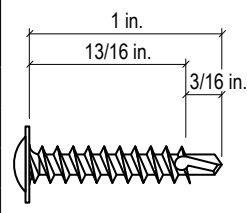

Item No.	Drill Point
36RG	#3
Screw Length: 1 1/4 in.	
Thread Length: 1 1/16 in.	
Drill Point Length: 3/16 in.	

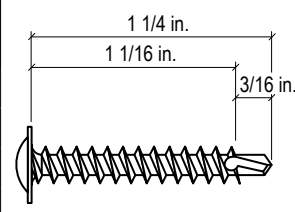

Item No.	Drill Point
37RG	#3
Screw Length: 1 5/8 in.	
Thread Length: 1 7/16 in.	
Drill Point Length: 3/16 in.	

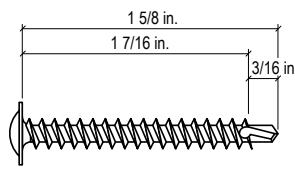

Item No.	Drill Point
240G	#3
Screw Length: 3 1/2 in.	
Thread Length: 1 13/16 in.	
Drill Point Length: 3/16 in.	

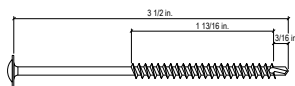

Item No.	Drill Point
241G	#3
Screw Length: 4 in.	
Thread Length: 1 13/16 in.	
Drill Point Length: 3/16 in.	

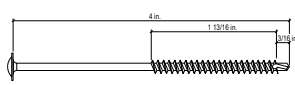

Item No.	Drill Point
242G	#3
Screw Length: 5 in.	
Thread Length: 1 13/16 in.	
Drill Point Length: 3/16 in.	

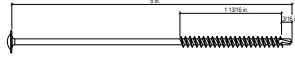

# Thread Length

## Heavy-Gauge Steel



### Heavy-Gauge Steel: PS1045

Item No.	Drill Point
10058P3RG	#3
Screw Length: 5/8 in.	
Thread Length: 7/16 in.	
Drill Point Length: 3/16 in.	

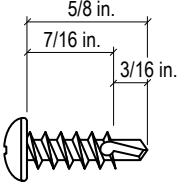

Item No.	Drill Point
CFP121878LRG	#3.5
Screw Length: 7/8 in.	
Thread Length: 5/8 in.	
Drill Point Length: 1/4 in.	

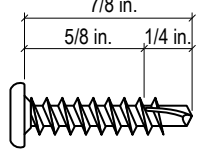

Item No.	Drill Point
FP101875JBWRG	#3
FLP101875LRG	#3
CFP101875JBWRG	#3
Screw Length: 3/4 in.	
Thread Length: 1/2 in.	
Drill Point Length: 1/4 in.	

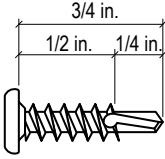

Item No.	Drill Point
10100PSS	#3
Screw Length: 1 in.	
Thread Length: 13/16 in.	
Drill Point Length: 3/16 in.	

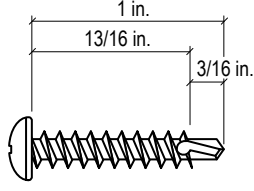

Item No.	Drill Point
10075P3RG	#3
Screw Length: 3/4 in.	
Thread Length: 9/16 in.	
Drill Point Length: 3/16 in.	

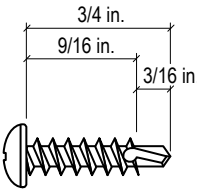

## Thread Length

Heavy-Gauge Steel

**GRABBER**  
CONSTRUCTION PRODUCTS

### Heavy-Gauge Steel: PS1046

Item No.	Drill Point	
DMWH138G2	#3	
Screw Length: 1 3/8 in.		
Thread Length: 1 3/16 in.		
Drill Point Length: 3/16 in.		

Item No.	Drill Point	
DMWH238G2	#3	
Screw Length: 2 3/8 in.		
Thread Length: 2 3/16 in.		
Drill Point Length: 3/16 in.		

### Heavy-Gauge Steel: PS1047

Item No.	Drill Point	
FP101875XDG	#3.5	
Screw Length: 3/4 in.		
Thread Length: 3/8 in.		
Drill Point Length: 3/8 in.		

# Thread Length

## Heavy-Gauge Steel



### Heavy-Gauge Steel: PS1048

Item No.	Drill Point	
30SSRG	#3	
Screw Length: 2 3/8 in.		
Thread Length: 1 7/16 in.		
Drill Point Length: 3/16 in.		

Item No.	Drill Point	
30LSRG	#3	
Screw Length: 3 in.		
Thread Length: 1 11/16 in.		
Drill Point Length: 3/16 in.		

### Heavy-Gauge Steel: PS1049

Item No.	Drill Point	
17SD410	#3	
Screw Length: 1 5/8 in.		
Thread Length: 15/16 in.		
Drill Point Length: 3/16 in.		

Item No.	Drill Point	
17SD76RG	#3	
Screw Length: 3 in.		
Thread Length: 1 11/16 in.		
Drill Point Length: 3/16 in.		

### Heavy-Gauge Steel: PS1050

Item No.	Drill Point	
C14RG8F2	#3	
Screw Length: 1 1/4 in.		
Thread Length: 15/16 in.		
Drill Point Length: 3/16 in.		

Item No.	Drill Point	
101716W3RG	#3	
Screw Length: 1 7/16 in.		
Thread Length: 3/4 in.		
Drill Point Length: 1/4 in.		

Item No.	Drill Point	
101716RG	#3	
Screw Length: 1 7/16 in.		
Thread Length: 1 1/16 in.		
Drill Point Length: 3/16 in.		

## Thread Length

### Heavy-Gauge Steel

**GRABBER**  
CONSTRUCTION PRODUCTS

#### Heavy-Gauge Steel: PS1054

Item No.	Drill Point	
C8100SDUC	#3	
C8100SDUCP	#3	
Screw Length: 1 in.		
Thread Length: 11/16 in.		
Drill Point Length: 3/16 in.		

Item No.	Drill Point	
10150WSDZ	#3	
Screw Length: 1 1/2 in.		
Thread Length: 15/16 in.		
Drill Point Length: 3/16 in.		

Item No.	Drill Point	
8125SDZWP	#3	
Screw Length: 1 1/4 in.		
Thread Length: 5/8 in.		
Drill Point Length: 3/16 in.		

Item No.	Drill Point	
10158W4	#4	
Screw Length: 1 5/8 in.		
Thread Length: 1 in.		
Drill Point Length: 1/2 in.		

Item No.	Drill Point	
101716	#3	
Screw Length: 1 7/16 in.		
Thread Length: 1 1/16 in.		
Drill Point Length: 3/16 in.		

Item No.	Drill Point	
10175WSDZ	#3	
Screw Length: 1 3/4 in.		
Thread Length: 1 1/16 in.		
Drill Point Length: 3/16 in.		

Item No.	Drill Point	
101716W3	#3	
Screw Length: 1 7/16 in.		
Thread Length: 3/4 in.		
Drill Point Length: 1/4 in.		



Grabber Thread and Drill Point Length  
PS1074 USA-ENG Rev. 3-26

Grabber Construction Products, Inc.  
3125 W. Executive Pkwy., Suite 200  
Lehi, UT 84048

(800) 477-8876 | [GrabberPro.com](http://GrabberPro.com)

Specific fasteners are listed in ICC Evaluation Services Reports, ESR-1271, ESR-3531, ESR-4223, ESR-5417, ESR-5429, and ESR-5616.

**SAFETY FIRST:** Wear appropriate personal protective equipment. Read applicable SDS and literature before handling and installation.

**TECHNICAL INFORMATION:** Technical information contained herein is furnished without charge or obligation and is given and accepted at the recipient's sole risk. Because conditions of use may vary and are beyond our control, Grabber Construction Products makes no representation about, and is not responsible or liable for, the accuracy or reliability of data associated with uses of any product described herein. Grabber Construction Products reserves the right to modify this document without prior notice.

©2026 Grabber Construction Products, Inc. | All rights reserved | Printed in U.S.A.  
The trademarks Barracuda, Deckmaster, Fold-N-Go, Grabber, GrabberGard, Grabber Rocker, Hang Tite, Lox, Panelmax, Plylock, Pro Proven, Quickgrab, Scavenger, Scorpion, Stabber, Streaker, Stud-Lok, Superdrive, Superdrive Mach1, UltraPro, Vector Point, and Stylized G on Grabber Fasteners are trademarks of Grabber Construction Products, Inc. LEED and LEED Green Building Rating System are registered trademarks of the U.S. Green Building Council.

