

Brads and Finish Nails

Wood and Molding to Wood

GRABBER®
CONSTRUCTION PRODUCTS

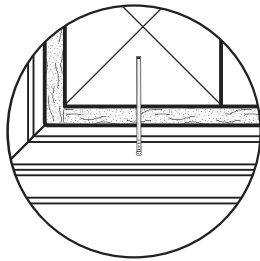

Base board

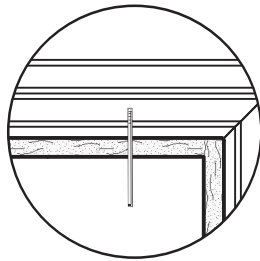
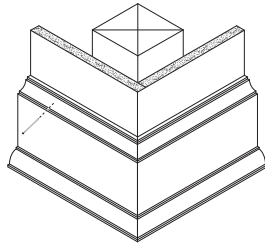

Crown molding

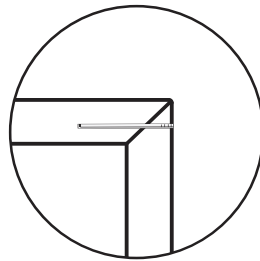
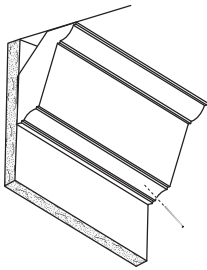

Finished wood-to-wood
assembly

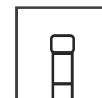
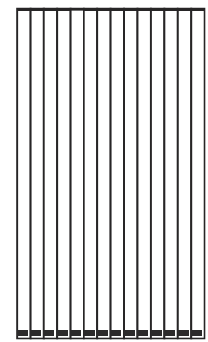
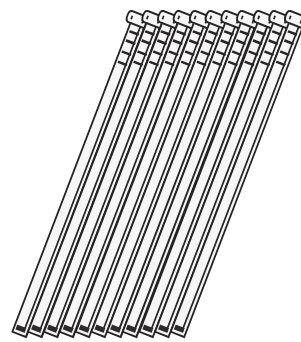
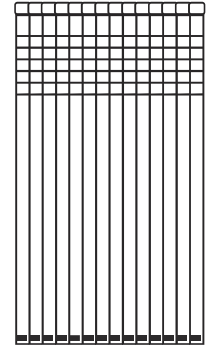
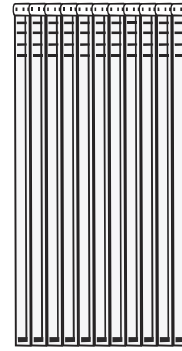
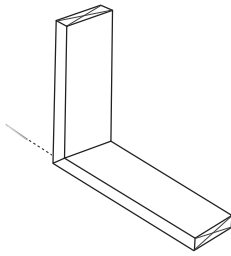

Brad Nail
Head



Finish Nail
Head

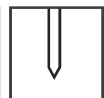

Chisel Point

Description Brads and Finish Nails.

Specifications

Size | Gauge: 23 to 15
Length: 1/2 in. to 2 1/2 in.
Head Type: Brad, Headless
Point Type: Chiseled
Finish: Electrogalvanized, Stainless Steel

Quality Assurance: Grabber® fasteners are manufactured in ISO 9001 and ISO 14001 certified and approved factories.

LEED Reporting: The post-consumer recycled steel content is 25%.

Compliance: The fasteners comply with ASTM F1667 performance requirements.

Applications

Brad Nails

- Fastening Trim
- Applying paneling
- Fastening thin molding
- Temporary fastening

Finish Nails

- Fastening larger, heavier molding
- Cabinet assembly
- Securing stair treads to risers
- Attaching door casing

Pin Nails

- Decorative molding
- Small molding
- Miter returns
- Kitchen molding

Brads and Finish Nails

Wood and Molding to Wood



- Installation**
- Always load the nails with the chiseled point facing away from the handle of the nail gun.
 - When choosing the nail length, multiply the length of the material being fastened by three, or the closest shorter length.
 - Choose the gauge based on the project:
 - Higher gauges (23 - 18) for more delicate work.
 - Lower gauges (16 - 15) for thicker materials or stronger holds.

- Features**
- Brad/Finish nails: small head for low-visibility fastening.
 - Pin nails: no head for lowest-visibility fastening.
 - Chiseled point for easy penetration into wood and molding.
 - Easy to conceal in the finished project.

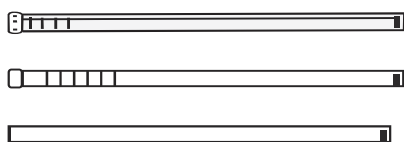

Product Dimensions

Gauge	Wire Dia.	Head Dia.
23	0.025 in.	0.025 in.
18	0.048 in.	0.049 in.
16	0.063 in.	0.068 in.
15	0.072 in.	0.077 in.

Ordering Information and Product Options

Item No.	Length	Gauge	Coating	Amount	Weight	Special Features
Brad Nails						
Straight						
F1858	5/8 in.	18	Electrogalvanized	5,000	2 lb.	
F1834	3/4 in.	18	Electrogalvanized	5,000	2 lb.	
B18034M	3/4 in.	18	Electrogalvanized	1,000	1 lb.	
F181	1 in.	18	Electrogalvanized	5,000	3 lb.	
B181M	1 in.	18	Electrogalvanized	1,000	1 lb.	
F18114	1 1/4 in.	18	Electrogalvanized	5,000	3 lb.	
B18114M	1 1/4 in.	18	Electrogalvanized	1,000	1 lb.	
F18112	1 1/2 in.	18	Electrogalvanized	5,000	4 lb.	
B18112M	1 1/2 in.	18	Electrogalvanized	1,000	1 lb.	
B18134M	1 3/4 in.	18	Electrogalvanized	1,000	1 lb.	
F182	2 in.	18	Electrogalvanized	5,000	5 lb.	
B182M	2 in.	18	Electrogalvanized	1,000	1 lb.	

Brads and Finish Nails

Wood and Molding to Wood

GRABBER
CONSTRUCTION PRODUCTS

Ordering Information and Product Options (continued)

Item No.	Length	Gauge	Coating	Amount	Weight	Special Features
Finish Nails						
Straight						
F161	1 in.	16	Electrogalvanized	2,500	4 lb.	
F161M	1 in.	16	Electrogalvanized	1,000	2 lb.	
F16114	1 1/4 in.	16	Electrogalvanized	2,500	5 lb.	
F16112	1 1/2 in.	16	Electrogalvanized	2,500	3 lb.	
F16112M	1 1/2 in.	16	Electrogalvanized	1,000	1 lb.	
F16134	1 3/4 in.	16	Electrogalvanized	2,500	4 lb.	
F16134M	1 3/4 in.	16	Electrogalvanized	1,000	2 lb.	
F162	2 in.	16	Electrogalvanized	2,500	4 lb.	
F162M	2 in.	16	Electrogalvanized	1,000	2 lb.	
F16212	2 1/2 in.	16	Electrogalvanized	2,500	5 lb.	
F16212M	2 1/2 in.	16	Electrogalvanized	1,000	2 lb.	
20° Angled						
FA162	2 in.	16	Electrogalvanized	2,000	4 lb.	
FA16212	2 1/2 in.	16	Electrogalvanized	2,000	4 lb.	
25° Angled						
FN15212	2 1/2 in.	15	Electrogalvanized	3,000	9 lb.	
33° Angled						
DA15G	1 1/4 in.	15	Electrogalvanized	4,000	6 lb.	
DA17G	1 1/2 in.	15	Electrogalvanized	4,000	7 lb.	
DA21G	2 in.	15	Electrogalvanized	4,000	10 lb.	
DA25G	2 1/2 in.	15	Electrogalvanized	3,000	12 lb.	
34° Angled						
FA15114M	1 1/4 in.	15	Electrogalvanized	1,000	2 lb.	
FA15112M	1 1/2 in.	15	Electrogalvanized	1,000	3 lb.	
FA152	2 in.	15	Electrogalvanized	3,650	10 lb.	
FA15200M	2 in.	15	Electrogalvanized	1,000	2 lb.	
FA15212	2 1/2 in.	15	Electrogalvanized	3,650	9 lb.	
FA15212M	2 1/2 in.	15	Electrogalvanized	1,000	3 lb.	
FA15212SS	2 1/2 in.	15	Stainless Steel	3,650	12 lb.	

Brads and Finish Nails

Wood and Molding to Wood



Ordering Information and Product Options (continued)

Item No.	Length	Gauge	Coating	Amount	Weight	Special Features
Pin Nails						
Straight						
P23012M	1/2 in.	23	Electrogalvanized	3,000	1/2 lb.	Headless
P23058M	5/8 in.	23	Electrogalvanized	3,000	1/2 lb.	
P23034M	3/4 in.	23	Electrogalvanized	3,000	1/2 lb.	
P23100M	1 in.	23	Electrogalvanized	3,000	1/2 lb.	
P231316M	1 3/16 in.	23	Electrogalvanized	3,000	1/2 lb.	
P23138M	1 3/8 in.	23	Electrogalvanized	3,000	1/2 lb.	

Note: Product availability is subject to change without prior notice, and the availability of products may differ from what is printed in literature and displayed on our website.

Brads and Finish Nails
PS1071 USA-ENG/Rev. 2-26

Grabber Construction Products, Inc.
3125 W. Executive Pkwy., Suite 200
Lehi, UT 84048

(800) 477-8876 | GrabberPro.com

SAFETY FIRST: Wear appropriate personal protective equipment. Read applicable SDS and literature before handling and installation.

TECHNICAL INFORMATION: Technical information contained herein is furnished without charge or obligation and is given and accepted at the recipient's sole risk. Because conditions of use may vary and are beyond our control, Grabber Construction Products makes no representation about, and is not responsible or liable for, the accuracy or reliability of data associated with uses of any product described herein. Grabber Construction Products reserves the right to modify this document without prior notice.

© 2026 Grabber Construction Products, Inc. | All rights reserved | Printed in U.S.A.
The trademarks Grabber, and Stylized G on Grabber Fasteners, are trademarks of Grabber Construction Products, Inc.

