



DIVISION: 03 00 00—CONCRETE
Section: 03 16 00—Concrete Anchors

DIVISION: 05 00 00—METALS
Section: 05 05 19—Post-Installed Concrete Anchors

REPORT HOLDER:

HILTI, INC.

EVALUATION SUBJECT:

HILTI HIT-RE 100 ADHESIVE ANCHORS AND POST INSTALLED REINFORCING BAR CONNECTIONS IN CRACKED AND UNCRACKED CONCRETE

1.0 EVALUATION SCOPE

Compliance with the following codes:

- 2021, 2018 and 2015 *International Building Code*® (IBC)
- 2021, 2018 and 2015 *International Residential Code*® (IRC)

For evaluation for compliance with codes adopted by the Los Angeles Department of Building and Safety (LADBS), see [ESR-3829 LABC and LARC Supplement](#).

Property evaluated:

Structural

2.0 USES

The Hilti HIT-RE 100 Adhesive Anchoring System is used as anchorage in cracked and uncracked normal-weight and lightweight concrete having a specified compressive strength, f'_c , of 2,500 psi to 8,500 psi (17.2 MPa to 58.6 MPa) to resist static, wind and earthquake (Seismic Design Categories A through F) tension and shear loads.

The anchor system complies with anchors as described in Section 1901.3 of the 2021, 2018 and 2015 IBC. The anchor system may also be used where an engineered design is submitted in accordance with Section R301.1.3 of the IRC.

The Hilti HIT-RE 100 Post-Installed Reinforcing Bar system is an alternative to cast-in-place reinforcing bars governed by ACI 318 and IBC Chapter 19.

3.0 DESCRIPTION

3.1 General:

The Hilti HIT-RE 100 Adhesive Anchoring System and Post-Installed Reinforcing Bar System are comprised of the following components:

- Hilti HIT-RE 100 adhesive packaged in foil packs
- Adhesive mixing and dispensing equipment
- Equipment for hole cleaning and adhesive injection

The Hilti HIT-RE 100 Adhesive Anchoring System may be used with continuously threaded rod or deformed steel reinforcing bars as depicted in Figure 4. The Hilti HIT-RE 100 Post-Installed Reinforcing Bar system may only be used with deformed steel reinforcing bars. The primary components of the Hilti Adhesive Anchoring System, including the Hilti HIT-RE 100 Adhesive, HIT-RE-M static mixing nozzle and steel anchoring elements, are shown in Figure 6 of this report.

The manufacturer's printed installation instructions (MPII), as included with each adhesive unit package, are replicated as Figure 7 of this report.

3.2 Materials:

3.2.1 Hilti HIT-RE 100 Adhesive: Hilti HIT-RE 100 Adhesive is an injectable, two-component epoxy adhesive. The two components are separated by means of a dual-cylinder foil pack attached to a manifold. The two components combine and react when dispensed through a static mixing nozzle attached to the manifold. Hilti HIT-RE 100 is available in 11.1-ounce (330 ml), 16.9-ounce (500 ml), and 47.3-ounce (1400 ml) foil packs. The manifold attached to each foil pack is stamped with the adhesive expiration date. The shelf life, as indicated by the expiration date, applies to an unopened foil pack stored in a dry, dark environment and in accordance with Figure 7 of this report.

3.2.2 Hole Cleaning Equipment:

3.2.2.1 Standard Equipment: Standard hole cleaning equipment, comprised of steel wire brushes and air nozzles, is described in Figure 7 of this report.

3.2.2.2 Hilti Safe-Set™ System: For the elements described in Section 3.2.4, the Hilti TE-CD and TE-YD hollow carbide drill bit with a carbide drilling head conforming to ANSI B212.15 must be used. Used in conjunction with a Hilti vacuum with a minimum value for the maximum volumetric flow rate of 129 CFM (61 l/s), the Hilti TE-CD or TE-YD drill bit will remove the drilling dust, automatically cleaning the hole.

3.2.3 Dispensers: Hilti HIT-RE 100 must be dispensed with manual dispensers, pneumatic dispensers, or electric dispensers provided by Hilti.

3.2.4 Anchor Elements:

3.2.4.1 Threaded Steel Rods: Threaded steel rods must be clean, continuously threaded rods (all-thread) in

diameters as described in Tables 4 and 9 and Figure 4 of this report. Steel design information for common grades of threaded rods is provided in Table 2. Carbon steel threaded rods must be furnished with a 0.0002-inch-thick (0.005 mm) zinc electroplated coating in compliance with ASTM B633 SC 1 or must be hot-dip galvanized in compliance with ASTM A153, Class C or D. Stainless steel threaded rods must comply with ASTM F593 or ISO 3506 A4. Threaded steel rods must be straight and free of indentations or other defects along their length. The ends may be stamped with identifying marks, and the embedded end may be blunt cut or cut on the bias to a chisel point.

3.2.4.2 Steel Reinforcing Bars for use in Post-Installed Anchor Applications: Steel reinforcing bars are deformed bars as described in Table 3 of this report. Tables 5, 9, and 13 and Figure 4 summarize reinforcing bar size ranges. The embedded portions of reinforcing bars must be straight, and free of mill scale, rust, mud, oil and other coatings (other than zinc) that may impair the bond with the adhesive. Reinforcing bars must not be bent after installation except as set forth in ACI 318-19 Section 26.6.3.2(b) (ACI 318-14 Section 26.6.3.1(b)) with the additional condition that the bars must be bent cold, and heating of reinforcing bars to facilitate field bending is not permitted.

3.2.4.3 Ductility: In accordance with ACI 318-19 and ACI 318-14 Section 2.3, in order for a steel element to be considered ductile, the tested elongation must be at least 14 percent and reduction of area must be at least 30 percent. Steel elements with a tested elongation of less than 14 percent or a reduction of area of less than 30 percent, or both, are considered brittle. Values for various steel materials are provided in Tables 2 and 3 of this report. Where values are nonconforming or unstated, the steel must be considered brittle.

3.2.5 Steel Reinforcing Bars for use in Post-Installed Reinforcing Bar Connections: Steel reinforcing bars used in post-installed reinforcing bar connections are deformed bars (rebar). Tables 16, 17, and 18 and Figure 4 summarize reinforcing bar size ranges. The embedded portions of reinforcing bars must be straight and free of millscale, rust, and other coatings that may impair the bond with the adhesive. Reinforcing bars must not be bent after installation, except as set forth in ACI 318-19 Section 26.6.3.2(b) (ACI 318-14 Section 26.6.3.1(b)) with the additional condition that the bars must be bent cold, and heating of reinforcing bars to facilitate field bending is not permitted.

3.3 Concrete:

Normal-weight and lightweight concrete must comply with Sections 1903 and 1905 of the IBC, as applicable. The specified compressive strength of the concrete must be from 2,500 psi to 8,500 psi (17.2 MPa to 58.6 MPa).

4.0 DESIGN AND INSTALLATION

4.1 Strength Design of Post-Installed Anchors:

Refer to Table 1 for the design parameters for specific installed elements, and refer to Figure 5 and Section 4.1.4 for a flowchart to determine the applicable design bond strength or pullout strength.

4.1.1 General: The design strength of anchors under the 2021 IBC, as well as the 2021 IRC, must be determined in accordance with ACI 318-19 Chapter 17 and this report. The design strength of anchors under the 2018 and 2015 IBC, as well as the 2018 and 2015 IRC, must be determined in accordance with ACI 318-14 Chapter 17 and this report.

Design parameters are provided in Tables 4 through 15 and based on ACI 318-19 for use with the 2021 IBC (ACI 318-14 for use with the 2018 and 2015 IBC) unless noted otherwise in Sections 4.1.1 through 4.1.11 of this report.

The strength design of anchors must comply with ACI 318-19 Section 17.5.1.2 (ACI 318-14 Section 17.3.1), except as required in ACI 318-19 Section 17.10 (ACI 318-14 Section 17.2.3).

Strength reduction factors, ϕ , as given in ACI 318-19 Section 17.5.3 (ACI 318-14 Section 17.3.3) must be used for load combinations calculated in accordance with Section 1605.1 of the 2021 IBC (Section 1605.2 of the 2018 and 2015 IBC) or Section 5.3 of ACI 318 (-19 or -14).

4.1.2 Static Steel Strength in Tension: The nominal static steel strength of a single anchor in tension, N_{sa} , in accordance with ACI 318-19 Section 17.6.1.2 (ACI 318-14 Section 17.4.1.2) and the associated strength reduction factors, ϕ , in accordance with ACI 318-19 Section 17.5.3 (ACI 318-14 Section 17.3.3) are provided in the tables outlined in Table 1 for the anchor element types included in this report.

4.1.3 Static Concrete Breakout Strength in Tension: The nominal concrete breakout strength of a single anchor or group of anchors in tension, N_{cb} or N_{cbg} , must be calculated in accordance with ACI 318-19 Section 17.6.2 (ACI 318-14 Section 17.4.2) with the following addition:

The basic concrete breakout strength of a single anchor in tension, N_b , must be calculated in accordance with ACI 318-19 Section 17.6.2.2 (ACI 318-14 Section 17.4.2.2) using the values of $k_{c,cr}$ and $k_{c,uncr}$ as described in this report. Where analysis indicates no cracking in accordance with ACI 318-19 Section 17.6.2.5 (ACI 318-14 Section 17.4.2.6), N_b must be calculated using $k_{c,uncr}$ and $\Psi_{c,N} = 1.0$. See Table 1. For anchors in lightweight concrete, see ACI 318-19 Section 17.2.4 (ACI 318-14 Section 17.2.6). The value of f'_c used for calculation must be limited to 8,000 psi (55 MPa) in accordance with ACI 318-19 Section 17.3.1 (ACI 318-14 Section 17.2.7). Additional information for the determination of nominal bond strength in tension is given in Section 4.1.4 of this report.

4.1.4 Static Bond Strength in Tension: The nominal static bond strength of a single adhesive anchor or group of adhesive anchors in tension, N_a or N_{ag} , must be calculated in accordance with ACI 318-19 Section 17.6.5 (ACI 318-14 Section 17.4.5). Bond strength values are a function of the concrete compressive strength, whether the concrete is cracked or uncracked, the concrete temperature range, and the installation conditions (dry, water-saturated, etc.). The resulting characteristic bond strength shall be multiplied by the associated strength reduction factor ϕ_{mn} as follows:

DRILLING METHOD	CONCRETE TYPE	PERMISSIBLE INSTALLATION CONDITIONS	BOND STRENGTH	ASSOCIATED STRENGTH REDUCTION FACTOR
Hammer-drill	Uncracked	Dry	$\tau_{k,uncr}$	ϕ_d
		Water-saturated	$\tau_{k,uncr}$	ϕ_{ws}
		Water-filled hole	$\tau_{k,uncr}$	ϕ_{wf}
		Underwater application	$\tau_{k,uncr}$	ϕ_{uw}
	Cracked	Dry	$\tau_{k,cr}$	ϕ_d
		Water-saturated	$\tau_{k,cr}$	ϕ_{ws}
		Water-filled hole	$\tau_{k,cr}$	ϕ_{wf}
		Underwater application	$\tau_{k,cr}$	ϕ_{uw}
Hammer-drill with Hilti TE-YD or TE-CD Hollow Drill Bit	Uncracked	Dry	$\tau_{k,uncr}$	ϕ_d
		Water-saturated	$\tau_{k,uncr}$	ϕ_{ws}
	Cracked	Dry	$\tau_{k,cr}$	ϕ_d
		Water-saturated	$\tau_{k,cr}$	ϕ_{ws}

Figure 5 of this report presents a bond strength design selection flowchart. Strength reduction factors for determination of the bond strength are outlined in Table 7, 8, 11, 12 and 15 of this report. Adjustments to the bond strength may also be made for increased concrete compressive strength as noted in the footnotes to the bond strength tables.

4.1.5 Static Steel Strength in Shear: The nominal static strength of a single anchor in shear as governed by the steel, V_{sa} , in accordance with ACI 318-19 Section 17.7.1.2 (ACI 318-14 Section 17.5.1.2) and strength reduction factors, ϕ , in accordance with ACI 318-19 Section 17.5.3 (ACI 318-14 Section 17.3.3) are given in the tables outlined in Table 1 for the anchor element types included in this report.

4.1.6 Static Concrete Breakout Strength in Shear: The nominal static concrete breakout strength of a single anchor or group of anchors in shear, V_{cb} or V_{cbg} , must be calculated in accordance with ACI 318-19 Section 17.7.2 (ACI 318-14 Section 17.5.2) based on information given in the tables outlined in Table 1. The basic concrete breakout strength of a single anchor in shear, V_b , must be calculated in accordance with ACI 318-19 Section 17.7.2.2 (ACI 318-14 Section 17.5.2.2) using the values of d given in the tables as outlined in Table 1 for the corresponding anchor steel in lieu of d_a (2021, 2018 and 2015 IBC). In addition, h_{ef} must be substituted for ℓ_e . In no case must ℓ_e exceed $8d$. The value of f'_c must be limited to a maximum of 8,000 psi (55 MPa) in accordance with ACI 318-19 Section 17.3.1 (ACI 318-14 Section 17.2.7).

4.1.7 Static Concrete Pryout Strength in Shear: The nominal static pryout strength of a single anchor or group of anchors in shear, V_{cp} or V_{cpg} , must be calculated in accordance with ACI 318-19 Section 17.7.3 (ACI 318-14 Section 17.5.3).

4.1.8 Interaction of Tensile and Shear Forces: For designs that include combined tension and shear, the interaction of tension and shear loads must be calculated in accordance with ACI 318-19 Section 17.8 (ACI 318-14 Section 17.6).

4.1.9 Minimum Member Thickness, h_{min} , Anchor Spacing, s_{min} and Edge Distance, c_{min} : In lieu of ACI 318-19 Section 17.9.2 (ACI 318-14 Sections 17.7.1 and 17.7.3), values of s_{min} and c_{min} described in this report must be observed for anchor design and installation. Likewise, in lieu of ACI 318-19 Section 17.9.4 (ACI 318-14 Section 17.7.5), the minimum member thicknesses, h_{min} , described in this report must be observed for anchor design and installation. For adhesive anchors that will remain untorqued, ACI 318-19 Section 17.9.3 (ACI 318-14 Section 17.7.4) applies.

For edge distances c_{ai} and anchor spacing s_{ai} , the maximum torque T_{max} shall comply with the following requirements:

REDUCED MAXIMUM INSTALLATION TORQUE $T_{max,red}$ FOR EDGE DISTANCES $c_{ai} < (5 \times d_a)$		
EDGE DISTANCE, c_{ai}	MINIMUM ANCHOR SPACING, s_{ai}	MAXIMUM TORQUE, $T_{max,red}$
1.75 in. (45 mm) $\leq c_{ai} < 5 \times d_a$	$5 \times d_a \leq s_{ai} < 16$ in.	$0.3 \times T_{max}$
	$s_{ai} \geq 16$ in. (406 mm)	$0.5 \times T_{max}$

4.1.10 Critical Edge Distance c_{ac} and $\psi_{cp,Na}$: The modification factor, $\psi_{cp,Na}$, must be determined in

accordance with ACI 318-19 Section 17.6.5.5 (ACI 318-14 Section 17.4.5.5) except as noted below:

For all cases where $c_{Na}/c_{ac} < 1.0$, $\psi_{cp,Na}$ determined from ACI 318-19 Eq. 17.6.5.5.1b (ACI 318-14 Eq. 17.4.5.5b) need not be taken less than c_{Na}/c_{ac} . For all other cases, $\psi_{cp,Na}$ shall be taken as 1.0.

The critical edge distance, c_{ac} , must be calculated according to Eq. 17.6.5.5.1c for ACI 318-19 (Eq. 17.4.5.5c for ACI 318-14) in lieu of ACI 318-19 Section 17.9.5 (ACI 318-14 Section 17.7.6).

$$c_{ac} = h_{ef} \left(\frac{\tau_{k,uncr}}{1160} \right)^{0.4} \cdot \left[3.1 - 0.7 \frac{h}{h_{ef}} \right]$$

(Eq. 17.6.5.5.1c for ACI 318-19 or Eq 17.4.5.5c for ACI 318-14)

where

$\left[\frac{h}{h_{ef}} \right]$ need not be taken as larger than 2.4; and

$\tau_{k,uncr}$ = the characteristic bond strength stated in the tables of this report whereby $\tau_{k,uncr}$ need not be taken as larger than:

$$\tau_{k,uncr} = \frac{k_{uncr} \sqrt{h_{ef} f'_c}}{\pi \cdot d_a} \tag{Eq. (4-1)}$$

4.1.11 Design Strength in Seismic Design Categories C, D, E and F: In structures assigned to Seismic Design Category C, D, E or F under the IBC or IRC, the design must be performed according to ACI 318-19 Section 17.10 (ACI 318-14 Section 17.2.3). Modifications to ACI 318-19 Section 17.10 (ACI 318-14 Section 17.2.3) shall be applied under Section 1905.1.8 of the 2021, 2018 and 2015 IBC.

The nominal steel shear strength, V_{sa} , must be adjusted by $\alpha_{V,seis}$ as given in the tables summarized in Table 1 for the anchor element types included in this report. For tension, the nominal pullout strength $N_{p,cr}$ or bond strength τ_{cr} must be adjusted by $\alpha_{N,seis}$. See Tables 7, 8, 11, 12 and 15.

4.2 Strength Design of Post-Installed Reinforcing Bars:

4.2.1 General: The design of straight post-installed deformed reinforcing bars must be determined in accordance with ACI 318 rules for cast-in place reinforcing bar development and splices and this report.

Examples of typical applications for the use of post-installed reinforcing bars are illustrated in Figures 2 and 3 of this report.

4.2.2 Determination of bar development length l_d : Values of l_d must be determined in accordance with the ACI 318 development and splice length requirements for straight cast-in place reinforcing bars.

Exceptions:

1. For uncoated and zinc-coated (galvanized) post-installed reinforcing bars, the factor Ψ_e shall be taken as 1.0. For all other cases, the requirements in ACI 318-19 Section 25.4.2.5 (ACI 318-14 Section 25.4.2.4) shall apply.
2. When using alternate methods to calculate the development length (e.g., anchor theory), the applicable factors for post-installed anchors generally apply.

4.2.3 Minimum Member Thickness, h_{min} , Minimum Concrete Cover, $c_{c,min}$, Minimum Concrete Edge Distance, $c_{b,min}$, Minimum Spacing, $s_{b,min}$: For post-installed reinforcing bars, there is no limit on the minimum member thickness. In general, requirements on

concrete cover and spacing applicable to straight cast-in bars designed in accordance with ACI 318-19 under the 2021 IBC (ACI 318-14 under the 2018 and 2015 IBC) shall be maintained.

For post-installed reinforcing bars installed at embedment depths, h_{ef} , larger than $20d$ ($h_{ef} > 20d$), the minimum concrete cover shall be as follows:

REBAR SIZE	MINIMUM CONCRETE COVER, $c_{c,min}$
$d_b \leq \text{No. 6 (16 mm)}$	$1^{3/16}$ in. (30mm)
$\text{No. 6} < d_b \leq \text{No. 10}$ (16mm < $d_b \leq 32$ mm)	$1^{9/16}$ in. (40mm)

The following requirements apply for minimum concrete edge and spacing for $h_{ef} > 20d$:

Required minimum edge distance for post-installed reinforcing bars (measured from the center of the bar):

$$c_{b,min} = d_o/2 + c_{c,min}$$

Required minimum center-to-center spacing between post-installed bars:

$$s_{b,min} = d_o + c_{c,min}$$

Required minimum center-to-center spacing from existing (parallel) reinforcing:

$$s_{b,min} = d_b/2 \text{ (existing reinforcing)} + d_o/2 + c_{c,min}$$

All other requirements applicable to straight cast-in place bars designed in accordance with ACI 318 shall be maintained.

4.2.4 Design Strength in Seismic Design Categories C, D, E and F: In structures assigned to Seismic Category C, D, E or F under the IBC or IRC, design of straight post-installed reinforcing bars must take into account the provisions of ACI 318-19 under the 2021 IBC (ACI 318-14 under the 2018 and 2015 IBC) Chapter 18. The value of f'_c to be used in calculations per ACI 318-19 Sections 25.4.2.3, 25.4.2.4 and 25.4.9.2 (ACI 318-14 Sections 25.4.2.2, 25.4.2.3, and 25.4.9.2) shall not exceed 2,500 psi.

4.3 Installation:

Installation parameters are illustrated in Figure 1. Installation must be in accordance with ACI 318-19 Section 26.7.2 (ACI 318-14 Sections 17.8.1 and 17.8.2). Anchor and post-installed reinforcing bar locations must comply with this report and the plans and specifications approved by the code official. Installation of the Hilti HIT-RE 100 Adhesive Anchor and Post-Installed Reinforcing Bar Systems must conform to the manufacturer's printed installation instructions (MPII) included in each unit package as provided in Figure 7 of this report. The MPII contains additional requirements for combinations of drill hole depth, diameter, and dispensing and installation equipment.

The initial cure time, $t_{cure,ini}$, as noted in Figure 7 of this report, is intended for rebar applications only and is the time where rebar and concrete formwork preparation may continue. Between the initial cure time and the full cure time, $t_{cure,final}$, the adhesive has a limited load bearing capacity. Do not apply a torque or load on the rebar during this time.

4.4 Special Inspection:

Periodic special inspection must be performed where required in accordance with Section 1705.1.1 and Table 1705.3 of the 2021, 2018 and 2015 IBC, and this report. The special inspector must be on the jobsite initially during anchor and post-installed reinforcing bar installation to verify

anchor and post-installed reinforcing bar type and dimensions, concrete type, concrete compressive strength, adhesive identification and expiration date, hole dimensions, hole cleaning procedures, spacing, edge distances, concrete thickness, anchor and post-installed reinforcing bars embedment, tightening torque and adherence to the manufacturer's printed installation instructions.

The special inspector must verify the initial installations of each type and size of adhesive anchor and post-installed reinforcing bar by construction personnel on site. Subsequent installations of the same anchor and post-installed reinforcing bar type and size by the same construction personnel are permitted to be performed in the absence of the special inspector. Any change in the anchor and post-installed reinforcing bar product being installed or the personnel performing the installation requires an initial inspection. For ongoing installations over an extended period, the special inspector must make regular inspections to confirm correct handling and installation of the product.

Continuous special inspection of adhesive anchors and post-installed reinforcing bars installed in horizontal or upwardly inclined orientations to resist sustained tension loads shall be performed in accordance with ACI 318-19 Sections 26.7.2, 26.7.1(j) and 26.13.3.2(e) (ACI 318-14 Sections 17.8.2.4, 26.7.1(h), and 26.13.3.2(c)).

Under the IBC, additional requirements as set forth in Sections 1705, 1706, and 1707 must be observed, where applicable.

5.0 CONDITIONS OF USE

The Hilti HIT-RE 100 Adhesive Anchor System and Post-Installed Reinforcing Bars described in this report complies with or is a suitable alternative to what is specified in the codes listed in Section 1.0 of this report, subject to the following conditions:

- 5.1** Hilti HIT-RE 100 Adhesive anchors and post-installed reinforcing bars must be installed in accordance with the manufacturer's printed installation instructions as included in the adhesive packaging and provided in Figure 7 of this report.
- 5.2** The anchors and post-installed reinforcing bars must be installed in cracked and uncracked normal-weight and lightweight concrete having a specified compressive strength $f'_c = 2,500$ psi to 8,500 psi (17.2 MPa to 58.6 MPa).
- 5.3** The values of f'_c used for calculation purposes must not exceed 8,000 psi (55.1 MPa) except as noted in Section 4.2.4 of this report.
- 5.4** The concrete shall have attained its minimum compressive strength prior to the installation of anchors and post-installed reinforcing bars.
- 5.5** Anchors and post-installed reinforcing bars must be installed in concrete base materials in holes predrilled in accordance with the instructions in Figure 7, using carbide-tipped drill bits manufactured with the range of maximum and minimum drill-tip dimensions specified in ANSI B212.15-1994.
- 5.6** Loads applied to the anchors must be adjusted in accordance with Section 1605.1 of the 2021 IBC or Section 1605.2 of the 2018 and 2015 IBC for strength design and in accordance with Section 1605.1 of the 2021 IBC or Section 1605.3 of the 2018 and 2015 IBC for allowable stress design.

- 5.7 Hilti HIT-RE 100 adhesive anchors and post-installed reinforcing bars are recognized for use to resist short-term and long-term loads, including wind and earthquake, subject to the conditions of this report.
- 5.8 In structures assigned to Seismic Design Category C, D, E or F under the IBC or IRC, anchor strength must be adjusted in accordance with Section 4.1.11 of this report and post-installed reinforcing bars must comply with Section 4.2.4 of this report.
- 5.9 Hilti HIT-RE 100 adhesive anchors and post-installed reinforcing bars are permitted to be installed in concrete that is cracked or that may be expected to crack during the service life of the anchor, subject to the conditions of this report.
- 5.10 Anchor strength design values must be established in accordance with Section 4.1 of this report.
- 5.11 Post-installed reinforcing bar development and splice length is established in accordance with Section 4.2 of this report.
- 5.12 Minimum anchor spacing and edge distance as well as minimum member thickness must comply with the values noted in this report.
- 5.13 Prior to installation, calculations and details demonstrating compliance with this report must be submitted to the code official. The calculations and details must be prepared by a registered design professional where required by the statutes of the jurisdiction in which the project is to be constructed.
- 5.14 Anchors and post-installed reinforcing bars are not permitted to support fire-resistive construction. Where not otherwise prohibited by the code, Hilti HIT-RE 100 adhesive anchors are permitted for installation in fire-resistive construction provided that at least one of the following conditions is fulfilled:
- Anchors and post-installed reinforcing bars are used to resist wind or seismic forces only.
 - Anchors and post-installed reinforcing bars that support gravity load-bearing structural elements are within a fire-resistive envelope or a fire-resistive membrane, are protected by approved fire-resistive materials, or have been evaluated for resistance to fire exposure in accordance with recognized standards.
 - Anchors and post-installed reinforcing bars are used to support nonstructural elements.
- 5.15 Since an ICC-ES acceptance criteria for evaluating data to determine the performance of adhesive anchors and post-installed reinforcing bars subjected to fatigue or shock loading is unavailable at this time, the use of these anchors under such conditions is beyond the scope of this report.
- 5.16 Use of zinc-plated carbon steel threaded rods or steel reinforcing bars is limited to dry, interior locations.
- 5.17 Use of hot-dipped galvanized carbon steel and stainless steel rods is permitted for exterior exposure or damp environments.
- 5.18 Steel anchoring materials in contact with preservative-treated and fire-retardant-treated wood must be of zinc-coated carbon steel or stainless steel. The minimum coating weights for zinc-coated steel must comply with ASTM A153.
- 5.19 Periodic special inspection must be provided in accordance with Section 4.4 of this report. Continuous special inspection for anchors and post-installed reinforcing bars installed in horizontal or upwardly inclined orientations to resist sustained tension loads must be provided in accordance with Section 4.4 of this report.
- 5.20 Installation of anchors and post-installed reinforcing bars in horizontal or upwardly inclined orientations to resist sustained tension loads shall be performed by personnel certified by an applicable certification program in accordance with ACI 318-19 Section 26.7.2(e) (ACI 318-14 Sections 17.8.2.2 or 17.8.2.3).
- 5.21 Hilti HIT-RE 100 adhesive anchors may be used to resist tension and shear forces in floor, wall, and overhead installations only if installation is into concrete with a temperature between 41°F and 104°F (5°C and 40°C) for threaded rods and rebar. Overhead installations for hole diameters larger than $\frac{7}{16}$ -inch or 10mm require the use of piston plugs (HIT-SZ) during injection to the back of the hole. $\frac{7}{16}$ -inch or 10mm diameter holes may be injected directly to the back of the hole with the use of extension tubing on the end of the nozzle. The adhesive anchor must be supported until fully cured (i.e., with Hilti HIT-OHW wedges, or other suitable means). Where temporary restraint devices are used, their use shall not result in impairment of the anchor shear resistance.
- 5.22 Hilti HIT-RE 100 adhesive is manufactured by Hilti GmbH, Kaufering, Germany, under a quality-control program with inspections by ICC-ES.

6.0 EVIDENCE SUBMITTED

Data in accordance with the ICC-ES Acceptance Criteria for Post-installed Adhesive Anchors in Concrete (AC308), dated October 2022, which incorporates requirements in ACI 355.4 (-19 and -11), including but not limited to tests under freeze/thaw conditions (Table 3.2, Test Series 6); and quality-control documentation.

7.0 IDENTIFICATION

- 7.1 The ICC-ES mark of conformity, electronic labeling, or the evaluation report number (ICC-ES ESR-3829) along with the name, registered trademark, or registered logo of the report holder must be included in the product label.
- 7.2 Hilti HIT-RE 100 adhesive is identified by packaging labeled with the company name (Hilti) and address, product name, lot number, expiration date.
- 7.3 Threaded rods, nuts, washers, and deformed reinforcing bars are standard elements and must conform to applicable national or international specifications.
- 7.4 The report holder's contact information is the following:

HILTI, INC.

7250 DALLAS PARKWAY, SUITE 1000
PLANO, TEXAS 75024
(800) 879-8000
www.hilti.com

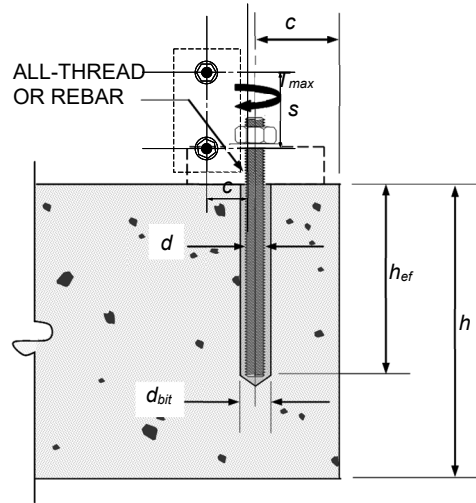

THREADED ROD/REINFORCING BAR

FIGURE 1—INSTALLATION PARAMETERS FOR POST-INSTALLED ADHESIVE ANCHORS

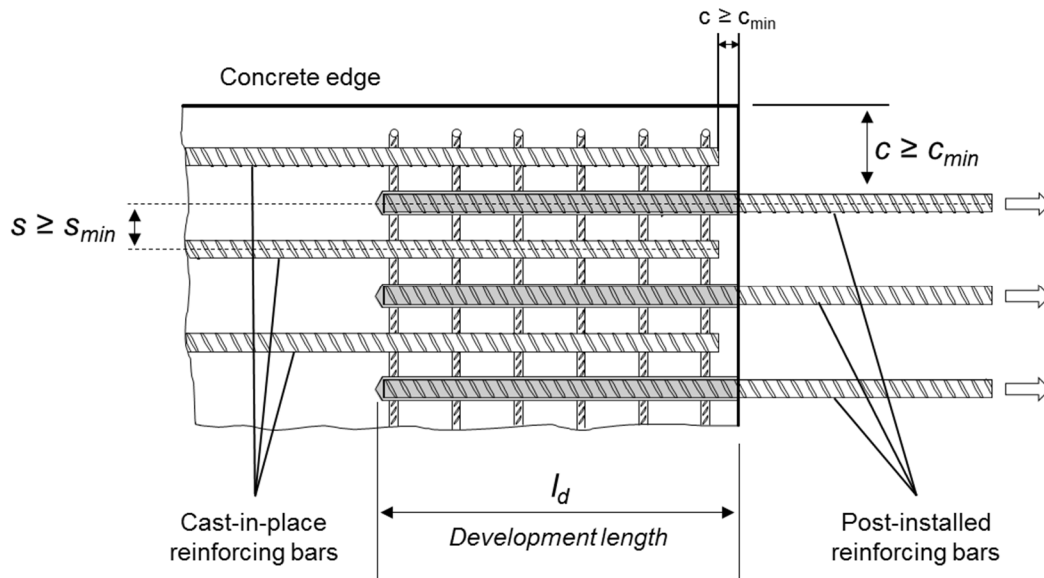

FIGURE 2—INSTALLATION PARAMETERS FOR POST-INSTALLED REINFORCING BARS

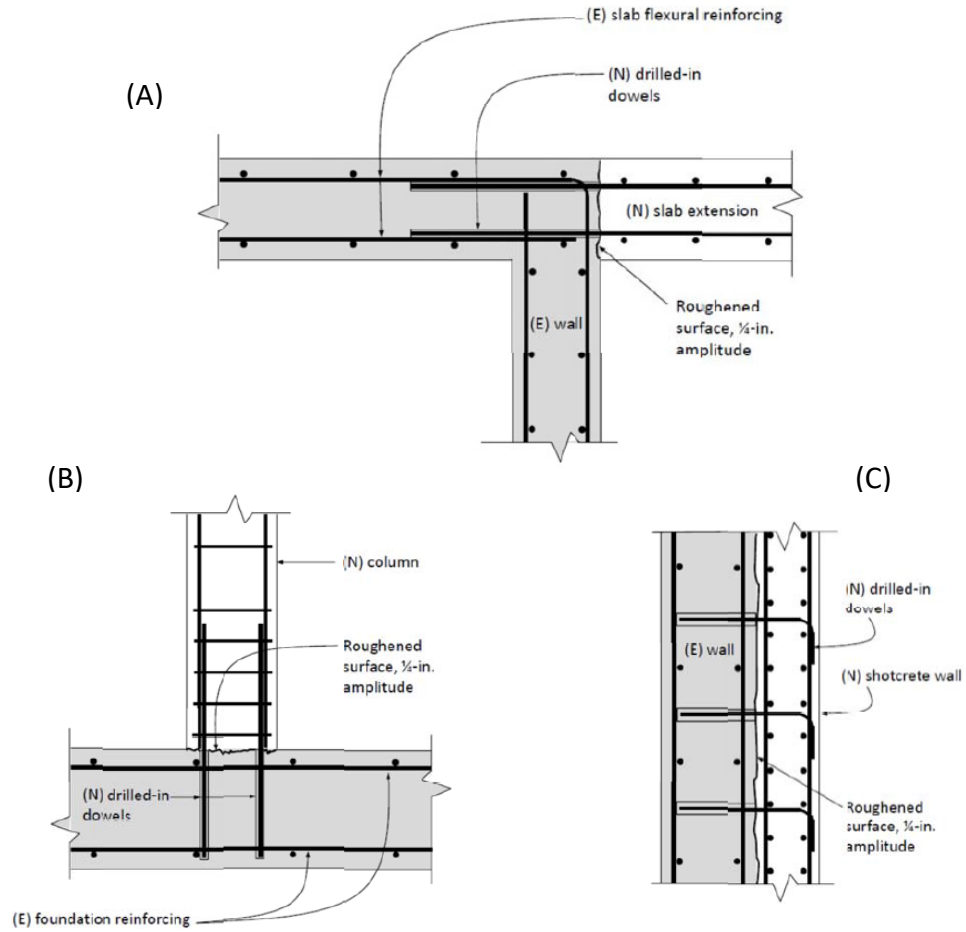
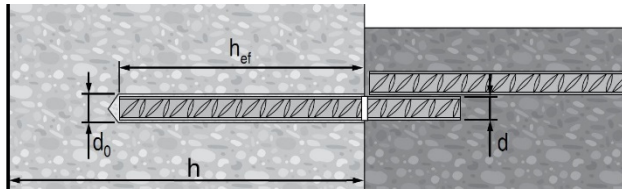

FIGURE 3—(A) TENSION LAP SPLICE WITH EXISTING FLEXURAL REINFORCEMENT; (B) TENSION DEVELOPMENT OF COLUMN DOWELS; (C) DEVELOPMENT OF SHEAR DOWELS FOR NEW ONLY SHEAR WALL

DEFORMED REINFORCEMENT



US Rebar

d	Ø d ₀ [inch]	h _{ef} [inch]
# 3	1/2	2 3/8...22 1/2
# 4	5/8	2 3/4...30
# 5	3/4	3 1/8...37 1/2
	7/8	3 1/2...15
# 6	1	15...45
	1 1/8	17 1/2...52 1/2
# 7	1 1/8	4...20
	1 1/4	20...60
# 8	1 3/8	4 1/2...67 1/2
# 9	1 1/2	5...75
# 10	1 3/4	5 1/2...82 1/2
# 11		

CA Rebar

d	Ø d ₀ [inch]	h _{ef} [mm]
10 M	3/16	70...678
15 M	3/4	80...960
20 M	1	90...1170
25 M	1 1/4 (32 mm)	101...1512
30 M	1 1/2	120...1794

EU Rebar

Ø d [mm]	Ø d ₀ [mm]	h _{ef} [mm]
8	12	60...480
10	14	60...600
12	16	70...720
14	18	75...840
16	20	80...960
18	22	85...1080
20	25	90...1200
22	28	95...1320
24	32	96...1440
25	32	100...1500
26	35	104...1560
28	35	112...1680
30	37	120...1800
32	40	128...1920

THREADED ROD

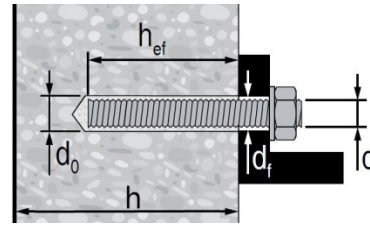

HAS / HIT-V

Ø d [inch]	Ø d ₀ [inch]	h _{ef} [inch]	Ø d _f [inch]	T _{max} [ft-lb]	T _{max} [Nm]
3/8	7/16	2 3/8... 7 1/2	7/16	15	20
1/2	9/16	2 3/4... 10	9/16	30	41
5/8	3/4	3 1/8... 12 1/2	11/16	60	81
	7/8	3 1/2... 15	13/16	100	136
7/8	1	3 1/2... 17 1/2	15/16	125	169
	1 1/8	4...20	1 1/8	150	203
1 1/4	1 3/8	5...25	1 3/8	200	271

HIT-V

Ø d [mm]	Ø d ₀ [mm]	h _{ef} [mm]	Ø d _f [mm]	T _{max} [Nm]
M8	10	60...160	9	10
M10	12	60...200	12	20
M12	14	70...240	14	40
M16	18	80...320	18	80
M20	22	90...400	22	150
M24	28	96...480	26	200
M27	30	108...540	30	270
M30	35	120...600	33	300

FIGURE 4—INSTALLATION PARAMETERS

TABLE 1—DESIGN TABLE INDEX

Design Table		Fractional		Metric	
		Table	Page	Table	Page
 Standard Threaded Rod	Steel Strength - N_{sa}, V_{sa}	4	11	9	16
	Concrete Breakout - $N_{cb}, N_{cbg}, V_{cb}, V_{cbg}, V_{cp}, V_{cpb}$	6	13	10	17
	Bond Strength - N_a, N_{ag}	8	15	12	19

Design Table		Fractional		EU Metric		Canadian	
		Table	Page	Table	Page	Table	Page
 Steel Reinforcing Bars	Steel Strength - N_{sa}, V_{sa}	5	12	9	16	13	20
	Concrete Breakout - $N_{cb}, N_{cbg}, V_{cb}, V_{cbg}, V_{cp}, V_{cpb}$	6	13	10	17	14	21
	Bond Strength - N_a, N_{ag}	7	14	11	18	15	22
	Determination of development length for post-installed reinforcing bar connections	16	23	17	23	18	24

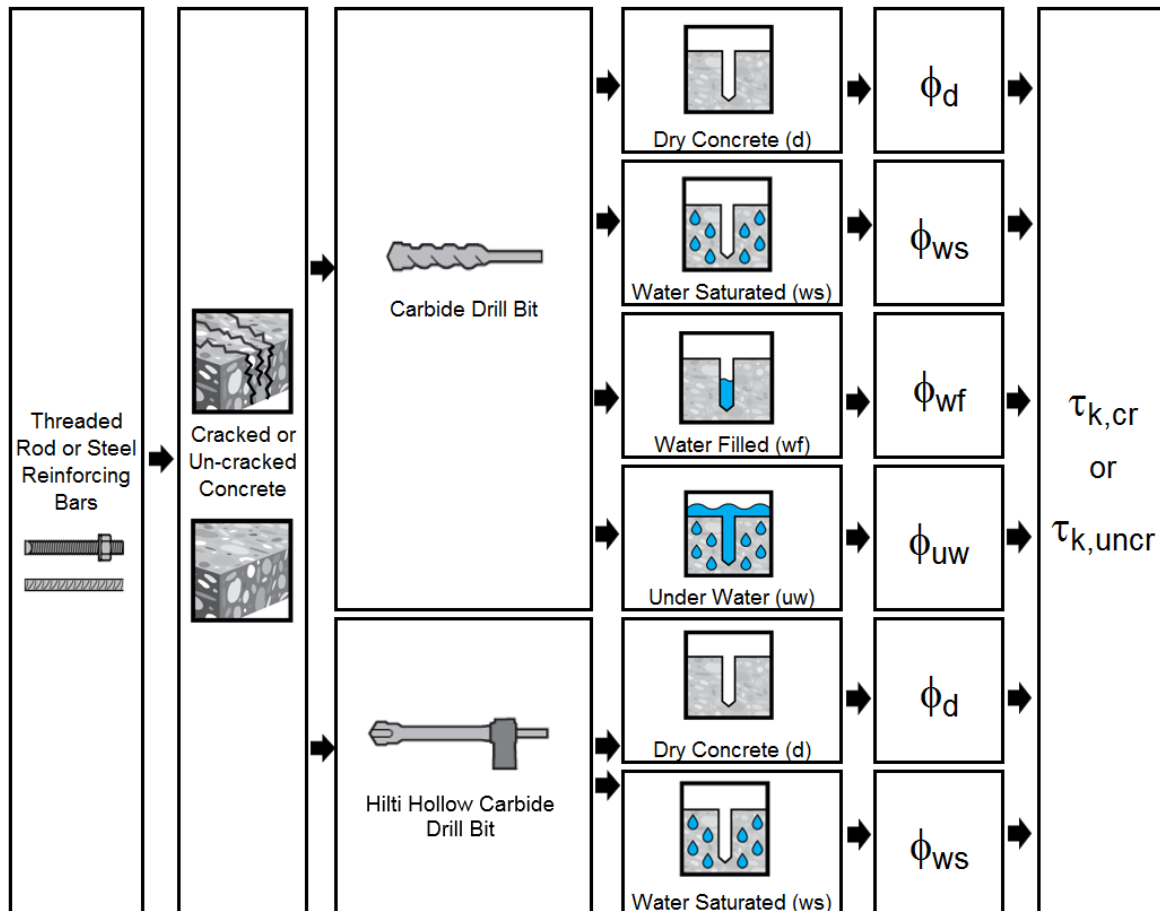

FIGURE 5—FLOWCHART FOR THE ESTABLISHMENT OF DESIGN BOND STRENGTH

TABLE 2—SPECIFICATIONS AND PHYSICAL PROPERTIES OF COMMON CARBON AND STAINLESS STEEL THREADED ROD MATERIALS¹

THREADED ROD SPECIFICATION			Minimum specified ultimate strength, f_{uta}	Minimum specified yield strength 0.2 percent offset, f_{ya}	f_{uta}/f_{ya}	Elongation, min. percent ⁶	Reduction of Area, min. percent	Specification for nuts ⁸
CARBON STEEL	ASTM A193 ² Grade B7 ≤ 2 1/2 in. (≤ 64 mm)	psi (MPa)	125,000 (862)	105,000 (724)	1.19	16	50	ASTM A563 Grade DH
	ASTM F568M3 Class 5.8 M5 (1/4 in.) to M24 (1 in.) (equivalent to ISO 898-1)	psi (MPa)	72,500 (500)	58,000 (400)	1.25	10	35	ASTM A563 Grade DH ⁹ DIN 934 (8-A2K)
	ASTM F1554, Grade 36 ⁶	psi (MPa)	58,000 (400)	36,000 (248)	1.61	23	40	ASTM A194 or ASTM A563
	ASTM F1554, Grade 55 ⁶	psi (MPa)	75,000 (517)	55,000 (379)	1.36	21	30	ASTM A194 or ASTM A563
	ASTM F1554, Grade 105 ⁶	psi (MPa)	125,000 (862)	105,000 (724)	1.19	15	45	ASTM A194 or ASTM A563
	ISO 898-1 ³ Class 5.8	MPa (psi)	500 (72,500)	400 (58,000)	1.25	22	-	DIN 934 Grade 6
	ISO 898-1 ³ Class 8.8	MPa (psi)	800 (116,000)	640 (92,800)	1.25	12	52	DIN 934 Grade 8
STAINLESS STEEL	ASTM F593 ⁴ CW1 (316) 1/4-in. to 3/8-in.	psi (MPa)	100,000 (689)	65,000 (448)	1.54	20	-	ASTM F594
	ASTM F593 ⁴ CW2 (316) 3/4-in. to 1 1/2-in.	psi (MPa)	85,000 (586)	45,000 (310)	1.89	25	-	ASTM F594
	ASTM A193 Grade 8(M), Class 1 ² 1 1/4-in.	psi (MPa)	75,000 (517)	30,000 (207)	2.50	30	50	ASTM F594
	ISO 3506-1 ⁵ A4-70 M8 – M24	MPa (psi)	700 (101,500)	450 (65,250)	1.56	40	-	ISO 4032
	ISO 3506-1 ⁵ A4-50 M27 – M30	MPa (psi)	500 (72,500)	210 (30,450)	2.38	40	-	ISO 4032

¹Hilti HIT-RE 100 adhesive may be used in conjunction with all grades of continuously threaded carbon or stainless steel rod (all-thread) that comply with the code reference standards and that have thread characteristics comparable with ANSI B1.1 UNC Coarse Thread Series or ANSI B1.13M M Profile Metric Thread Series. Values for threaded rod types and associated nuts supplied by Hilti are provided here.

²Standard Specification for Alloy-Steel and Stainless Steel Bolting Materials for High-Temperature Service

³Mechanical properties of fasteners made of carbon steel and alloy steel – Part 1: Bolts, screws and studs

⁴Standard Steel Specification for Stainless Steel Bolts, Hex Cap Screws, and Studs

⁵Mechanical properties of corrosion-resistant stainless steel fasteners – Part 1: Bolts, screws and studs

⁶Standard Specification for Anchor Bolts, Steel, 36, 55, and 105-ksi Yield Strength

⁷Based on 2-in. (50 mm) gauge length except for A 193, which are based on a gauge length of 4d and ISO 898, which is based on 5d.

⁸Nuts of other grades and styles having specified proof load stresses greater than the specified grade and style are also suitable. Nuts must have specified proof load stresses equal to or greater than the minimum tensile strength of the specified threaded rod.

⁹Nuts for fractional rods.

TABLE 3—SPECIFICATIONS AND PHYSICAL PROPERTIES OF COMMON STEEL REINFORCING BARS

REINFORCING BAR SPECIFICATION		Minimum specified ultimate strength, f_{uta}	Minimum specified yield strength, f_{ya}
ASTM A615 ¹ Gr. 60	psi (MPa)	80,000 (550)	60,000 (414)
ASTM A615 ¹ Gr. 40	psi (MPa)	60,000 (414)	40,000 (276)
ASTM A706 ² Gr. 60	psi (MPa)	80,000 (550)	60,000 (414)
DIN 488 ³ BSt 500	MPa (psi)	550 (79,750)	500 (72,500)
CAN/CSA-G30.18 ⁴ Gr. 400	MPa (psi)	540 (78,300)	400 (58,000)

¹Standard Specification for Deformed and Plain Carbon Steel Bars for Concrete Reinforcement

²Standard Specification for Low Alloy Steel Deformed and Plain Bars for Concrete Reinforcement

³Reinforcing steel; reinforcing steel bars; dimensions and masses

⁴Billet-Steel Bars for Concrete Reinforcement

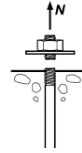

Fractional Threaded Rod

Steel Strength

TABLE 4—STEEL DESIGN INFORMATION FOR FRACTIONAL THREADED ROD

DESIGN INFORMATION		Symbol	Units	Nominal rod diameter (in.) ¹						
				3/8	1/2	5/8	3/4	7/8	1	1 1/4
Rod outside diameter		<i>d</i>	in. (mm)	0.375 (9.5)	0.5 (12.7)	0.625 (15.9)	0.75 (19.1)	0.875 (22.2)	1 (25.4)	1.25 (31.8)
Rod effective cross-sectional area		<i>A_{se}</i>	in. ² (mm ²)	0.0775 (50)	0.1419 (92)	0.2260 (146)	0.3345 (216)	0.4617 (298)	0.6057 (391)	0.9691 (625)
ISO 898-1 Class 5.8	Nominal strength as governed by steel strength	<i>N_{sa}</i>	lb (kN)	5,620 (25.0)	10,290 (45.8)	16,385 (72.9)	24,250 (107.9)	33,470 (148.9)	43,910 (195.3)	70,260 (312.5)
		<i>V_{sa}</i>	lb (kN)	3,370 (15.0)	6,175 (27.5)	9,830 (43.7)	14,550 (64.7)	20,085 (89.3)	26,345 (117.2)	42,155 (187.5)
	Reduction for seismic shear	<i>α_{V,seis}</i>	-	0.70						
	Strength reduction factor for tension ²	<i>φ</i>	-	0.65						
	Strength reduction factor for shear ²	<i>φ</i>	-	0.60						
ASTM A193 B7	Nominal strength as governed by steel strength	<i>N_{sa}</i>	lb (kN)	9,685 (43.1)	17,735 (78.9)	28,250 (125.7)	41,810 (186.0)	57,710 (256.7)	75,710 (336.8)	121,135 (538.8)
		<i>V_{sa}</i>	lb (kN)	5,810 (25.9)	10,640 (47.3)	16,950 (75.4)	25,085 (111.6)	34,625 (154.0)	45,425 (202.1)	72,680 (323.3)
	Reduction for seismic shear	<i>α_{V,seis}</i>	-	0.70						
	Strength reduction factor for tension ²	<i>φ</i>	-	0.75						
	Strength reduction factor for shear ²	<i>φ</i>	-	0.65						
ASTM F1554 Gr. 36	Nominal strength as governed by steel strength	<i>N_{sa}</i>	lb (kN)	- (-)	8,230 (36.6)	13,110 (58.3)	19,400 (86.3)	26,780 (119.1)	35,130 (156.3)	56,210 (250.0)
		<i>V_{sa}</i>	lb (kN)	- (-)	4,940 (22.0)	7,865 (35.0)	11,640 (51.8)	16,070 (71.5)	21,080 (93.8)	33,725 (150.0)
	Reduction for seismic shear	<i>α_{V,seis}</i>	-	0.60						
	Strength reduction factor for tension ²	<i>φ</i>	-	0.75						
	Strength reduction factor for shear ²	<i>φ</i>	-	0.65						
ASTM F1554 Gr. 55	Nominal strength as governed by steel strength	<i>N_{sa}</i>	lb (kN)	- (-)	10,645 (47.4)	16,950 (75.4)	25,090 (111.6)	34,630 (154.0)	45,430 (202.1)	72,685 (323.3)
		<i>V_{sa}</i>	lb (kN)	- (-)	6,385 (28.4)	10,170 (45.2)	15,055 (67.0)	20,780 (92.4)	27,260 (121.3)	43,610 (194.0)
	Reduction for seismic shear	<i>α_{V,seis}</i>	-	0.70						
	Strength reduction factor for tension ²	<i>φ</i>	-	0.75						
	Strength reduction factor for shear ²	<i>φ</i>	-	0.65						
ASTM F1554 Gr. 105	Nominal strength as governed by steel strength	<i>N_{sa}</i>	lb (kN)	- (-)	17,740 (78.9)	28,250 (125.7)	41,815 (186.0)	57,715 (256.7)	75,715 (336.8)	121,135 (538.8)
		<i>V_{sa}</i>	lb (kN)	- (-)	10,645 (47.4)	16,950 (75.4)	25,090 (111.6)	34,630 (154.0)	45,430 (202.1)	72,680 (323.3)
	Reduction for seismic shear	<i>α_{V,seis}</i>	-	0.70						
	Strength reduction factor for tension ²	<i>φ</i>	-	0.75						
	Strength reduction factor for shear ²	<i>φ</i>	-	0.65						
ASTM F593, CW Stainless	Nominal strength as governed by steel strength	<i>N_{sa}</i>	lb (kN)	7,750 (34.5)	14,190 (63.1)	22,600 (100.5)	28,435 (126.5)	39,245 (174.6)	51,485 (229.0)	- (-)
		<i>V_{sa}</i>	lb (kN)	4,650 (20.7)	8,515 (37.9)	13,560 (60.3)	17,060 (75.9)	23,545 (104.7)	30,890 (137.4)	- (-)
	Reduction for seismic shear	<i>α_{V,seis}</i>	-	0.70						
	Strength reduction factor for tension ²	<i>φ</i>	-	0.65						
	Strength reduction factor for shear ²	<i>φ</i>	-	0.60						
ASTM A193 Gr. 8(M), Class 1 Stainless	Nominal strength as governed by steel strength	<i>N_{sa}</i>	lb (kN)	-	-	-	-	-	-	55,240 (245.7)
		<i>V_{sa}</i>	lb (kN)	-	-	-	-	-	-	33,145 (147.4)
	Reduction for seismic shear	<i>α_{V,seis}</i>	-	0.60						
	Strength reduction factor for tension ²	<i>φ</i>	-	0.75						
	Strength reduction factor for shear ²	<i>φ</i>	-	0.65						

For **SI**: 1 inch = 25.4 mm, 1 lbf = 4.448 N. For **pound-inch** units: 1 mm = 0.03937 inches, 1 N = 0.2248 lbf

¹Values provided for common rod material types are based on specified strengths and calculated in accordance with ACI 318-19 Eq. (17.6.1.2) and Eq. (17.7.1.2b) or ACI 318-14 Eq. (17.4.1.2) and Eq. (17.5.1.2b), as applicable. Nuts and washers must be appropriate for the rod.

²The strength reduction factor applies when the load combinations from the IBC or ACI 318 are used and the requirements of ACI 318-19 17.5.3 or ACI 318-14 17.3.3, as applicable, are met.



Fractional Reinforcing Bars

Steel Strength

TABLE 5—STEEL DESIGN INFORMATION FOR FRACTIONAL REINFORCING BARS

DESIGN INFORMATION		Symbol	Units	Nominal Reinforcing bar size (Rebar)							
				#3	#4	#5	#6	#7	#8	#9	#10
Nominal bar diameter		d	in. (mm)	³ / ₈ (9.5)	¹ / ₂ (12.7)	⁵ / ₈ (15.9)	³ / ₄ (19.1)	⁷ / ₈ (22.2)	1 (25.4)	1.128 (28.7)	1.270 (32.3)
Bar effective cross-sectional area		A_{se}	in. ² (mm ²)	0.11 (71)	0.2 (129)	0.31 (199)	0.44 (284)	0.6 (387)	0.79 (510)	1.0 (645)	1.27 (819)
ASTM A615 Grade 40	Nominal strength as governed by steel strength	N_{sa}	lb (kN)	6,600 (29.4)	12,000 (53.4)	18,600 (82.7)	26,400 (117.4)	36,000 (160.1)	47,400 (210.9)	60,000 (266.9)	76,200 (339.0)
		V_{sa}	lb (kN)	3,960 (17.6)	7,200 (32.0)	11,160 (49.6)	15,840 (70.5)	21,600 (96.1)	28,440 (126.5)	36,000 (160.1)	45,720 (203.4)
	Reduction for seismic shear	$\alpha_{V,seis}$	-	0.70							
	Strength reduction factor ϕ for tension ²	ϕ	-	0.65							
				0.60							
ASTM A615 Grade 60	Nominal strength as governed by steel strength	N_{sa}	lb (kN)	8,800 (39.1)	16,000 (71.2)	24,800 (110.3)	35,200 (156.6)	48,000 (213.5)	63,200 (281.1)	80,000 (355.9)	101,600 (451.9)
		V_{sa}	lb (kN)	5,280 (23.5)	9,600 (42.7)	14,880 (66.2)	21,120 (93.9)	28,800 (128.1)	37,920 (168.7)	48,000 (213.5)	60,960 (271.2)
	Reduction for seismic shear	$\alpha_{V,seis}$	-	0.70							
	Strength reduction factor ϕ for tension ²	ϕ	-	0.65							
				0.60							
ASTM A706 Grade 60	Nominal strength as governed by steel strength	N_{sa}	lb (kN)	8,800 (39.1)	16,000 (71.2)	24,800 (110.3)	35,200 (156.6)	48,000 (213.5)	63,200 (281.1)	80,000 (355.9)	101,600 (452.0)
		V_{sa}	lb (kN)	5,280 (23.5)	9,600 (42.7)	14,880 (66.2)	21,120 (94.0)	28,800 (128.1)	37,920 (168.7)	48,000 (213.5)	60,960 (271.2)
	Reduction for seismic shear	$\alpha_{V,seis}$		0.70							
	Strength reduction factor ϕ for tension ²	ϕ		0.75							
				0.65							

For **SI**: 1 inch = 25.4 mm, 1 lbf = 4.448 N. For **pound-inch** units: 1 mm = 0.03937 inches, 1 N = 0.2248 lbf

¹Values provided for common rod material types are based on specified strengths and calculated in accordance with ACI 318-19 Eq. (17.6.1.2) and Eq. (17.7.1.2b) or ACI 318-14 Eq. (17.4.1.2) and Eq. (17.5.1.2b), as applicable. Nuts and washers must be appropriate for the rod.

²The strength reduction factor applies when the load combinations from the IBC or ACI 318 are used and the requirements of ACI 318-19 17.5.3 or ACI 318-14 17.3.3, as applicable, are met.

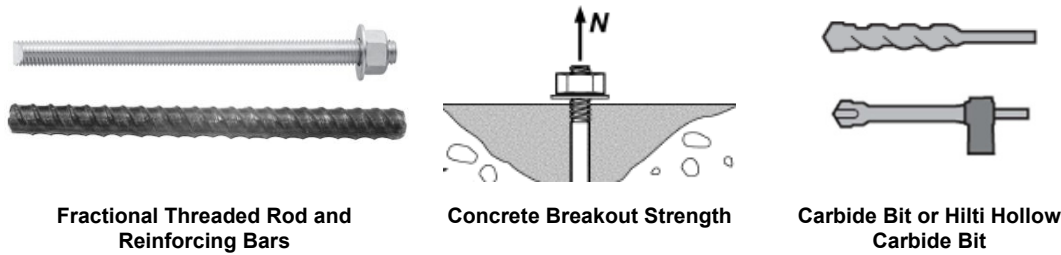

TABLE 6—CONCRETE BREAKOUT DESIGN INFORMATION FOR FRACTIONAL THREADED ROD AND REINFORCING BARS IN HOLES DRILLED WITH A HAMMER DRILL AND CARBIDE BIT (OR HILTI HOLLOW CARBIDE DRILL BIT)¹

DESIGN INFORMATION	Symbol	Units	Nominal rod diameter (in.) / Reinforcing bar size							
			3/8 or #3	1/2 or #4	5/8 or #5	3/4 or #6	7/8 or #7	1 or #8	#9	1 1/4 or #10
Effectiveness factor for cracked concrete	$k_{c,cr}$	in-lb (SI)	17 (7.1)							
Effectiveness factor for uncracked concrete	$k_{c,uncr}$	in-lb (SI)	24 (10)							
Minimum embedment	$h_{ef,min}$	in. (mm)	2 ³ / ₈ (60)	2 ³ / ₄ (70)	3 ¹ / ₈ (79)	3 ¹ / ₂ (89)	3 ¹ / ₂ (89)	4 (102)	4 ¹ / ₂ (114)	5 (127)
Maximum embedment	$h_{ef,max}$	in. (mm)	7 ¹ / ₂ (191)	10 (254)	12 ¹ / ₂ (318)	15 (381)	17 ¹ / ₂ (445)	20 (508)	22 ¹ / ₂ (572)	25 (635)
Minimum anchor spacing ³	s_{min}	in. (mm)	1 ⁷ / ₈ (48)	2 ¹ / ₂ (64)	3 ¹ / ₈ (79)	3 ³ / ₄ (95)	4 ³ / ₈ (111)	5 (127)	5 ⁵ / ₈ (143)	6 ¹ / ₄ (159)
Minimum edge distance ³	c_{min}	-	5d; or see Section 4.1.9 of this report for design with reduced minimum edge distances							
Minimum concrete thickness	h_{min}	in. (mm)	$h_{ef} + 1\frac{1}{4}$ ($h_{ef} + 30$)			$h_{ef} + 2d_o^{(4)}$				
Critical edge distance – splitting (for uncracked concrete)	c_{ac}	-	See Section 4.1.10 of this report.							
Strength reduction factor for tension, concrete failure modes, Condition B (supplemental reinforcement not present) ²	ϕ	-	0.65							
Strength reduction factor for shear, concrete failure modes, Condition B (supplemental reinforcement not present) ²	ϕ	-	0.70							

For **SI**: 1 inch = 25.4 mm, 1 lbf = 4.448 N, 1 psi = 0.006897 MPa.

For **pound-inch** units: 1 mm = 0.03937 inches, 1 N = 0.2248 lbf, 1 MPa = 145.0 psi

¹Additional setting information is described in Figure 7, Manufacturers Printed Installation Instructions (MPII).

²The strength reduction factor applies when the load combinations from the IBC or ACI 318 are used and the requirements of ACI 318-19 17.5.3 or ACI 318-14 17.3.3, as applicable, are met.

³For installations with 1 3/4-inch edge distance, refer to Section 4.1.9 of this report for spacing and maximum torque requirements.

⁴ d_o = hole diameter.

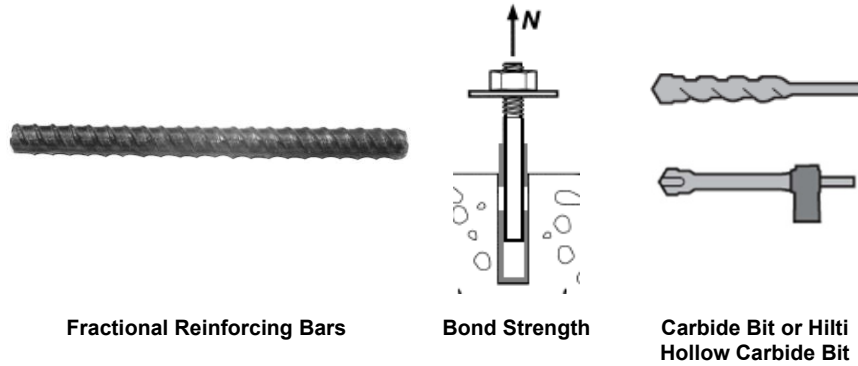

TABLE 7—BOND STRENGTH DESIGN INFORMATION FOR FRACTIONAL REINFORCING BARS IN HOLES DRILLED WITH A HAMMER DRILL AND CARBIDE BIT (OR HILTI HOLLOW CARBIDE DRILL BIT)^{1,2,3,4}

DESIGN INFORMATION		Symbol	Units	Nominal reinforcing bar size							
				#3	#4	#5	#6	#7	#8	#9	#10
Minimum embedment		$h_{ef,min}$	in.	2 ³ / ₈	2 ³ / ₄	3 ¹ / ₈	3 ¹ / ₂	3 ¹ / ₂	4	4 ¹ / ₂	5
			(mm)	(60)	(70)	(79)	(89)	(89)	(102)	(114)	(127)
Maximum embedment		$h_{ef,max}$	in.	7 ¹ / ₂	10	12 ¹ / ₂	15	17 ¹ / ₂	20	22 ¹ / ₂	25
			(mm)	(191)	(254)	(318)	(381)	(445)	(508)	(572)	(635)
Dry concrete	Characteristic bond strength in cracked concrete	$\tau_{k,cr}$	psi	476	476	476	476	476	452	428	408
			(MPa)	(3.3)	(3.3)	(3.3)	(3.3)	(3.3)	(3.1)	(3.0)	(2.8)
	Characteristic bond strength in uncracked concrete	$\tau_{k,uncr}$	psi	1,272	1,256	1,204	1,164	1,124	1,092	1,068	1,048
			(MPa)	(8.8)	(8.7)	(8.3)	(8.0)	(7.8)	(7.5)	(7.4)	(7.2)
Anchor category		-	-	2							
Strength reduction factor		ϕ_d	-	0.55							
Water saturated concrete, water-filled hole and underwater application	Characteristic bond strength in cracked concrete	$\tau_{k,cr}$	psi	424	420	420	405	386	356	330	300
			(MPa)	(2.9)	(2.9)	(2.9)	(2.8)	(2.7)	(2.5)	(2.3)	(2.1)
	Characteristic bond strength in uncracked concrete	$\tau_{k,uncr}$	psi	1,133	1,106	1,061	994	915	919	821	776
			(MPa)	(7.8)	(7.6)	(7.3)	(6.9)	(6.3)	(6.3)	(5.7)	(5.4)
Anchor category		-	-	3							
Strength reduction factor		ϕ_{ws} ϕ_{wf} ϕ_{uw}	-	0.45							

For **SI**: 1 inch = 25.4 mm, 1 lbf = 4.448 N, 1 psi = 0.006897 MPa.
 For **pound-inch** units: 1 mm = 0.03937 inches, 1 N = 0.2248 lbf, 1 MPa = 145.0 psi

¹Bond strength values correspond to concrete compressive strength $f_c = 2,500$ psi (17.2 MPa). For concrete compressive strength, f_c , between 2,500 psi (17.2 MPa) and 8,000 psi (55.2 MPa), the tabulated characteristic bond strength may be increased by a factor of $(f_c / 2,500)^{0.1}$ [For SI: $(f_c / 17.2)^{0.1}$]. See Section 4.1.4 of this report for bond strength determination.

²Bond strength values are for sustained loads including dead and live loads. For load combinations consisting of short-term loads only such as wind and seismic, bond strengths may be increased 40 percent.

³Values are for the following temperature range: maximum short term temperature = 130°F (55°C), maximum long term temperature = 110°F (43°C). Short term elevated concrete temperatures are those that occur over brief intervals, e.g., as a result of diurnal cycling. Long term concrete temperatures are roughly constant over significant periods of time.

⁴For structures assigned to Seismic Design Categories C, D, E or F, bond strength values must be multiplied by $\alpha_{N,seis} = 0.90$.

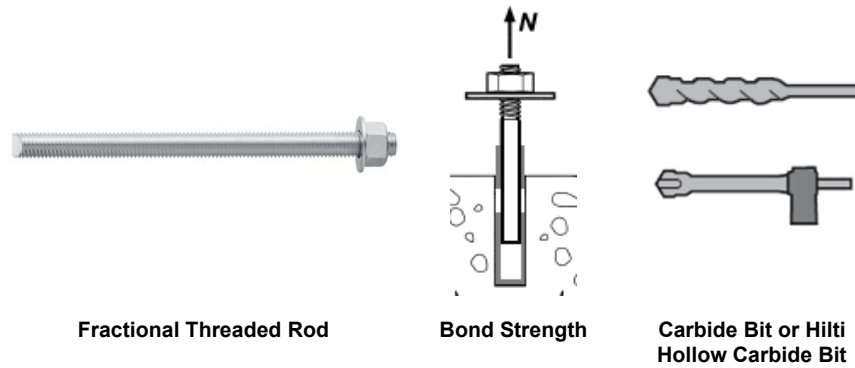

TABLE 8—BOND STRENGTH DESIGN INFORMATION FOR FRACTIONAL THREADED ROD IN HOLES DRILLED WITH A HAMMER DRILL AND CARBIDE BIT (OR HILTI HOLLOW CARBIDE DRILL BIT)^{1,2,3,4}

DESIGN INFORMATION		Symbol	Units	Nominal rod diameter (in.)						
				3/8	1/2	5/8	3/4	7/8	1	1 1/4
Minimum embedment		$h_{ef,min}$	in.	2 3/8	2 3/4	3 1/8	3 1/2	3 1/2	4	5
			(mm)	(60)	(70)	(79)	(89)	(89)	(102)	(127)
Maximum embedment		$h_{ef,max}$	in.	7 1/2	10	12 1/2	15	17 1/2	20	25
			(mm)	(191)	(254)	(318)	(381)	(445)	(508)	(635)
Dry concrete	Characteristic bond strength in cracked concrete	$\tau_{k,cr}$	psi	662	592	592	560	516	480	408
			(MPa)	(4.6)	(4.1)	(4.1)	(3.9)	(3.6)	(3.3)	(2.8)
	Characteristic bond strength in uncracked concrete	$\tau_{k,uncr}$	psi	1,272	1,256	1,204	1,164	1,124	1,092	1,048
			(MPa)	(8.8)	(8.7)	(8.3)	(8.0)	(7.8)	(7.5)	(7.2)
Anchor category		-	-	2						
Strength reduction factor		ϕ_d	-	0.55						
Water saturated concrete, water-filled hole and underwater application	Characteristic bond strength in cracked concrete	$\tau_{k,cr}$	psi	548	521	521	476	416	375	300
			(MPa)	(3.8)	(3.6)	(3.6)	(3.3)	(2.9)	(2.6)	(2.1)
	Characteristic bond strength in uncracked concrete	$\tau_{k,uncr}$	psi	1,133	1,106	1,061	994	915	859	776
			(MPa)	(7.8)	(7.6)	(7.3)	(6.9)	(6.3)	(5.9)	(5.4)
Anchor category		-	-	3						
Strength reduction factor		ϕ_{ws} ϕ_{wf} ϕ_{uw}	-	0.45						

For SI: 1 inch = 25.4 mm, 1 lbf = 4.448 N, 1 psi = 0.006897 MPa.

For pound-inch units: 1 mm = 0.03937 inches, 1 N = 0.2248 lbf, 1 MPa = 145.0 psi

¹Bond strength values correspond to concrete compressive strength $f'_c = 2,500$ psi (17.2 MPa). For concrete compressive strength, f'_c , between 2,500 psi (17.2 MPa) and 8,000 psi (55.2 MPa), the tabulated characteristic bond strength may be increased by a factor of $(f'_c / 2,500)^{0.1}$ [For SI: $(f'_c / 17.2)^{0.1}$]. See Section 4.1.4 of this report for bond strength determination.

²Bond strength values are for sustained loads including dead and live loads. For load combinations consisting of short-term loads only such as wind and seismic, bond strengths may be increased 40 percent.

³Values are for the following temperature range: maximum short term temperature = 130°F (55°C), maximum long term temperature = 110°F (43°C). Short-term elevated concrete temperatures are those that occur over brief intervals, e.g., as a result of diurnal cycling. Long-term concrete temperatures are roughly constant over significant periods of time.

⁴For structures assigned to Seismic Design Categories C, D, E or F, bond strength values must be multiplied by $\alpha_{N,seis} = 0.90$.



TABLE 9—STEEL DESIGN INFORMATION FOR METRIC THREADED ROD AND EU METRIC REINFORCING BARS

DESIGN INFORMATION		Symbol	Units	Nominal rod diameter (mm) ¹								
				8	10	12	16	20	24	27	30	
Rod outside diameter		<i>d</i>	mm (in.)	8 (0.31)	10 (0.39)	12 (0.47)	16 (0.63)	20 (0.79)	24 (0.94)	27 (1.06)	30 (1.18)	
Rod effective cross-sectional area		<i>A_{se}</i>	mm ² (in. ²)	36.6 (0.057)	58.0 (0.090)	84.3 (0.131)	157 (0.243)	245 (0.380)	353 (0.547)	459 (0.711)	561 (0.870)	
ISO 898-1 Class 5.8	Nominal strength as governed by steel strength	<i>N_{sa}</i>	kN (lb)	18.5 (4,114)	29.0 (6,519)	42.0 (9,476)	78.5 (17,647)	122.5 (27,539)	176.5 (39,679)	229.5 (51,594)	280.5 (63,059)	
		<i>V_{sa}</i>	kN (lb)	11.0 (2,480)	17.4 (3,912)	25.5 (5,685)	47.0 (10,588)	73.5 (16,523)	106.0 (23,807)	137.5 (30,956)	168.5 (37,835)	
	Reduction for seismic shear	<i>α_{V,seis}</i>	-	0.70								
	Strength reduction factor for tension ²	<i>φ</i>	-	0.65								
	Strength reduction factor for shear ²	<i>φ</i>	-	0.60								
ISO 898-1 Class 8.8	Nominal strength as governed by steel strength	<i>N_{sa}</i>	kN (lb)	29.5 (6,582)	46.5 (10,431)	67.5 (15,161)	125.5 (28,236)	196.0 (44,063)	282.5 (63,486)	367.0 (82,550)	449.0 (100,894)	
		<i>V_{sa}</i>	kN (lb)	17.6 (3,949)	27.8 (6,250)	40.5 (9,097)	75.5 (16,942)	117.5 (26,438)	169.5 (38,092)	220.5 (49,530)	269.5 (60,537)	
	Reduction for seismic shear	<i>α_{V,seis}</i>	-	0.70								
	Strength reduction factor for tension ²	<i>φ</i>	-	0.65								
	Strength reduction factor for shear ²	<i>φ</i>	-	0.60								
ISO 3506-1 Class A4 Stainless ³	Nominal strength as governed by steel strength	<i>N_{sa}</i>	kN (lb)	25.6 (5,760)	40.6 (9,127)	59.0 (13,266)	109.9 (24,706)	171.5 (38,555)	247.1 (55,550)	183.1 (41,172)	223.8 (50,321)	
		<i>V_{sa}</i>	kN (lb)	15.4 (3,456)	24.4 (5,485)	35.4 (7,960)	65.9 (14,824)	102.9 (23,133)	148.3 (33,330)	109.9 (24,703)	134.3 (30,192)	
	Reduction for seismic shear	<i>α_{V,seis}</i>	-	0.70								
	Strength reduction factor for tension ²	<i>φ</i>	-	0.65								
	Strength reduction factor for shear ²	<i>φ</i>	-	0.60								
DESIGN INFORMATION		Symbol	Units	Reinforcing bar size								
				8	10	12	14	16	20	25	28	32
Nominal bar diameter		<i>d</i>	mm (in.)	8.0 (0.315)	10.0 (0.394)	12.0 (0.472)	14.0 (0.551)	16.0 (0.630)	20.0 (0.787)	25.0 (0.984)	28.0 (1.102)	32.0 (1.260)
Bar effective cross-sectional area		<i>A_{se}</i>	mm ² (in. ²)	50.3 (0.078)	78.5 (0.122)	113.1 (0.175)	153.9 (0.239)	201.1 (0.312)	314.2 (0.487)	490.9 (0.761)	615.8 (0.954)	804.2 (1.247)
DIN 488 BSt 550/500	Nominal strength as governed by steel strength	<i>N_{sa}</i>	kN (lb)	27.5 (6,215)	43.0 (9,711)	62.0 (13,984)	84.5 (19,034)	110.5 (24,860)	173.0 (38,844)	270.0 (60,694)	338.5 (76,135)	442.5 (99,441)
		<i>V_{sa}</i>	kN (lb)	16.5 (3,729)	26.0 (5,827)	37.5 (8,390)	51.0 (11,420)	66.5 (14,916)	103.0 (23,307)	162.0 (36,416)	203.0 (45,681)	265.5 (59,665)
	Reduction for seismic shear	<i>α_{V,seis}</i>	-	0.70								
	Strength reduction factor for tension ²	<i>φ</i>	-	0.65								
	Strength reduction factor for shear ²	<i>φ</i>	-	0.60								

For **SI**: 1 inch ≅ 25.4 mm, 1 lbf = 4.448 N, 1 psi = 0.006897 MPa.
 For **pound-inch** units: 1 mm = 0.03937 inches, 1 N = 0.2248 lbf, 1 MPa = 145.0 psi

¹Values provided for common rod material types are based on specified strengths and calculated in accordance with ACI 318-19 Eq. (17.6.1.2) and Eq. (17.7.1.2b) or ACI 318-14 Eq. (17.4.1.2) and Eq. (17.5.1.2b), as applicable. Nuts and washers must be appropriate for the rod.

²The strength reduction factor applies when the load combinations from the IBC or ACI 318 are used and the requirements of ACI 318-19 17.5.3 or ACI 318-14 17.3.3, as applicable, are met.

³A4-70 Stainless (M8- M24); A4-502 Stainless (M27- M30).

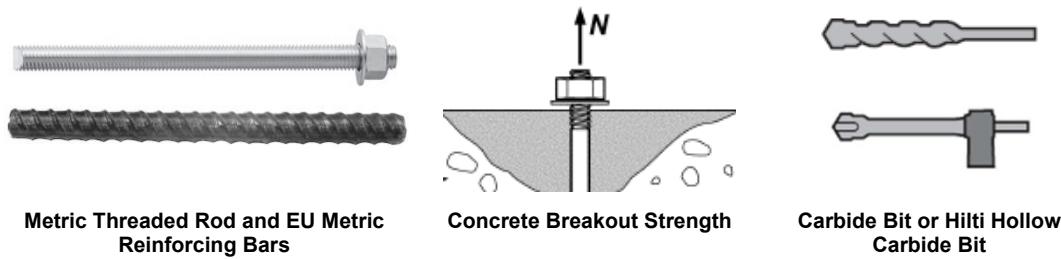

TABLE 10—CONCRETE BREAKOUT DESIGN INFORMATION FOR METRIC THREADED ROD AND EU METRIC REINFORCING BARS IN HOLES DRILLED WITH A HAMMER DRILL AND CARBIDE BIT (OR HILTI HOLLOW CARBIDE DRILL BIT)¹

DESIGN INFORMATION	Symbol	Units	Nominal rod diameter (mm)								
			8	10	12	16	20	24	27	30	
Effectiveness factor for cracked concrete	$k_{c,cr}$	SI (in-lb)	7.1 (17)								
Effectiveness factor for uncracked concrete	$k_{c,uncr}$	SI (in-lb)	10 (24)								
Minimum anchor spacing ³	s_{min}	mm (in.)	40 (1.6)	50 (2.0)	60 (2.4)	80 (3.2)	100 (3.9)	120 (4.7)	135 (5.3)	150 (5.9)	
Minimum edge distance ³	c_{min}	mm (in.)	40 (1.6)	50 (2.0)	60 (2.4)	80 (3.2)	100 (3.9)	120 (4.7)	135 (5.3)	150 (5.9)	
Minimum concrete thickness	h_{min}	mm (in.)	$h_{ef} + 30$ ($h_{ef} + 1\frac{1}{4}$)			$h_{ef} + 2d_o^{(4)}$					
Critical edge distance – splitting (for uncracked concrete)	c_{ac}	-	See Section 4.1.10 of this report.								
Strength reduction factor for tension, concrete failure modes, Condition B (supplemental reinforcement not present) ²	ϕ	-	0.65								
Strength reduction factor for shear, concrete failure modes, Condition B (supplemental reinforcement not present) ²	ϕ	-	0.70								
DESIGN INFORMATION	Symbol	Units	Reinforcing bar size								
			8	10	12	14	16	20	25	28	32
Effectiveness factor for cracked concrete	$k_{c,cr}$	SI (in-lb)	7.1 (17)								
Effectiveness factor for uncracked concrete	$k_{c,uncr}$	SI (in-lb)	10 (24)								
Minimum bar spacing ³	s_{min}	mm (in.)	40 (1.6)	50 (2.0)	60 (2.4)	70 (2.8)	80 (3.1)	100 (3.9)	125 (4.9)	140 (5.5)	160 (6.3)
Minimum edge distance ³	c_{min}	-	40 (1.6)	50 (2.0)	60 (2.4)	70 (2.8)	80 (3.1)	100 (3.9)	125 (4.9)	140 (5.5)	160 (6.3)
Minimum concrete thickness	h_{min}	mm (in.)	$h_{ef} + 30$ ($h_{ef} + 1\frac{1}{4}$)			$h_{ef} + 2d_o^{(4)}$					
Critical edge distance – splitting (for uncracked concrete)	c_{ac}	-	See Section 4.1.10 of this report.								
Strength reduction factor for tension, concrete failure modes, Condition B (supplemental reinforcement not present) ²	ϕ	-	0.65								
Strength reduction factor for shear, concrete failure modes, Condition B (supplemental reinforcement not present) ²	ϕ	-	0.70								

For SI: 1 inch ≡ 25.4 mm, 1 lbf = 4.448 N, 1 psi = 0.006897 MPa.

For pound-inch units: 1 mm = 0.03937 inches, 1 N = 0.2248 lbf, 1 MPa = 145.0 psi

¹Additional setting information is described in Figure 7, Manufacturers Printed Installation Instructions (MPII).

²The strength reduction factor applies when the load combinations from the IBC or ACI 318 are used and the requirements of ACI 318-19 17.5.3 or ACI 318-14 17.3.3, as applicable, are met.

³For installations with 1³/₄-inch edge distance, refer to Section 4.1.9 for spacing and maximum torque requirements.

⁴ d_o = hole diameter.

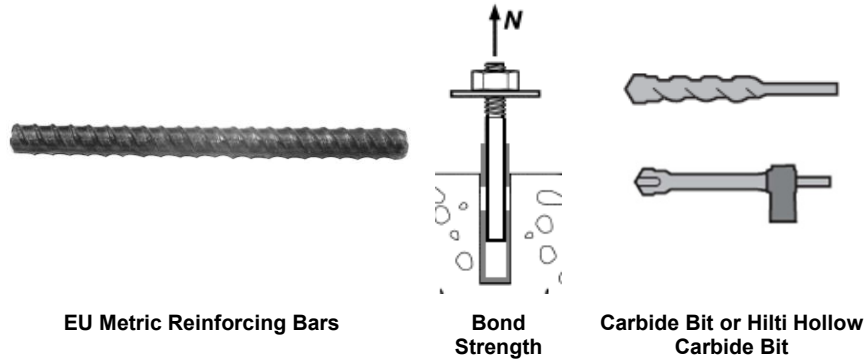

TABLE 11—BOND STRENGTH DESIGN INFORMATION FOR EU METRIC REINFORCING BARS IN HOLES DRILLED WITH A HAMMER DRILL AND CARBIDE BIT (OR HILTI HOLLOW CARBIDE DRILL BIT)^{1,2,3,4}

DESIGN INFORMATION		Symbol	Units	Reinforcing bar size								
				8	10	12	14	16	20	25	28	32
Minimum embedment		$h_{ef,min}$	mm (in.)	60 (2.4)	60 (2.4)	70 (2.8)	75 (3.0)	80 (3.1)	90 (3.5)	100 (3.9)	112 (4.4)	128 (5.0)
Maximum embedment		$h_{ef,max}$	mm (in.)	160 (6.3)	200 (7.9)	240 (9.4)	280 (11.0)	320 (12.6)	400 (15.7)	500 (19.7)	560 (22.0)	640 (25.2)
Dry concrete	Characteristic bond strength in cracked concrete	$\tau_{k,cr}$	MPa (psi)	-	3.3 (472)	3.3 (472)	3.3 (472)	3.3 (472)	3.3 (472)	3.2 (464)	3.0 (428)	2.8 (408)
	Characteristic bond strength in uncracked concrete	$\tau_{k,uncr}$	MPa (psi)	8.8 (1,272)	8.8 (1,272)	8.8 (1,272)	8.5 (1,236)	8.3 (1,204)	7.9 (1,148)	7.6 (1,100)	7.4 (1,072)	7.2 (1,048)
	Anchor category	-	-	2								
	Strength reduction factor	ϕ_{cd}	-	0.55								
Water saturated concrete, water-filled hole and underwater application	Characteristic bond strength in cracked concrete	$\tau_{k,cr}$	MPa (psi)	-	2.9 (424)	2.9 (420)	2.9 (420)	2.8 (413)	2.8 (401)	2.6 (371)	2.3 (330)	2.1 (300)
	Characteristic bond strength in uncracked concrete	$\tau_{k,uncr}$	MPa (psi)	7.8 (1,133)	7.8 (1,133)	7.7 (1,121)	7.6 (1,095)	7.2 (1,050)	6.7 (968)	6.1 (878)	5.7 (825)	5.4 (776)
	Anchor category	-	-	3								
	Strength reduction factor	ϕ_{ws} ϕ_{wf} ϕ_{uw}	-	0.45								

For **SI**: 1 inch \equiv 25.4 mm, 1 lbf = 4.448 N, 1 psi = 0.006897 MPa.
 For **pound-inch** units: 1 mm = 0.03937 inches, 1 N = 0.2248 lbf, 1 MPa = 145.0 psi

¹Bond strength values correspond to concrete compressive strength $f'_c = 2,500$ psi (17.2 MPa). For concrete compressive strength, f'_c , between 2,500 psi (17.2 MPa) and 8,000 psi (55.2 MPa), the tabulated characteristic bond strength may be increased by a factor of $(f'_c / 2,500)^{0.1}$ [For SI: $(f'_c / 17.2)^{0.1}$]. See Section 4.1.4 of this report for bond strength determination.

²Bond strength values are for sustained loads including dead and live loads. For load combinations consisting of short-term loads only such as wind and seismic, bond strengths may be increased 40 percent.

³Values are for the following temperature range: maximum short term temperature = 130°F (55°C), maximum long term temperature = 110°F (43°C). Short term elevated concrete temperatures are those that occur over brief intervals, e.g., as a result of diurnal cycling. Long term concrete temperatures are roughly constant over significant periods of time.

⁴For structures assigned to Seismic Design Categories C, D, E or F, bond strength values must be multiplied by $\alpha_{N,seis} = 0.90$.

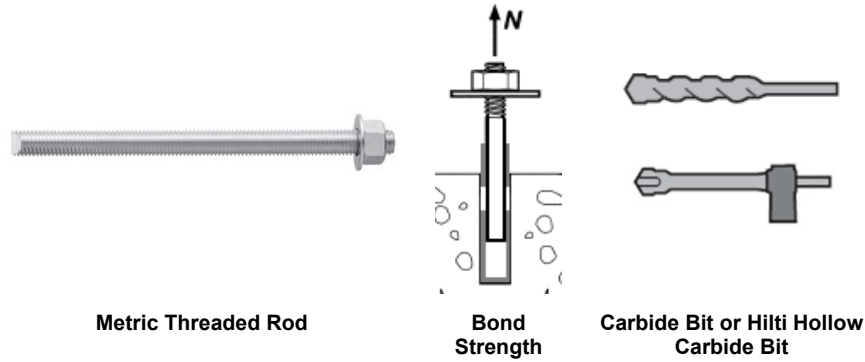

TABLE 12—BOND STRENGTH DESIGN INFORMATION FOR METRIC THREADED ROD IN HOLES DRILLED WITH A HAMMER DRILL AND CARBIDE BIT (OR HILTI HOLLOW CARBIDE DRILL BIT)^{1,2,3,4}

DESIGN INFORMATION	Symbol	Units	Nominal rod diameter (mm)								
			8	10	12	16	20	24	27	30	
Minimum embedment	$h_{ef,min}$	mm (in.)	60 (2.4)	60 (2.4)	70 (2.8)	80 (3.1)	90 (3.5)	96 (3.8)	108 (4.3)	120 (4.7)	
Maximum embedment	$h_{ef,max}$	mm (in.)	160 (6.3)	200 (7.9)	240 (9.4)	320 (12.6)	400 (15.7)	480 (18.9)	540 (21.3)	600 (23.6)	
Dry concrete	Characteristic bond strength in cracked concrete	$\tau_{k,cr}$ MPa (psi)	-	4.6 (662)	4.1 (592)	4.1 (592)	3.9 (560)	3.6 (516)	3.3 (480)	2.8 (408)	
	Characteristic bond strength in uncracked concrete	$\tau_{k,uncr}$ MPa (psi)	8.8 (1,272)	8.8 (1,272)	8.7 (1,256)	8.3 (1,204)	8.0 (1,164)	7.8 (1,124)	7.5 (1,092)	7.2 (1,048)	
	Anchor category	-	-	2							
	Strength reduction factor	ϕ_{cl}	-	0.55							
Water saturated concrete, water-filled hole and underwater application	Characteristic bond strength in cracked concrete	$\tau_{k,cr}$ MPa (psi)	-	3.8 (548)	3.6 (521)	3.6 (521)	3.3 (476)	2.9 (416)	2.6 (375)	2.1 (300)	
	Characteristic bond strength in uncracked concrete	$\tau_{k,uncr}$ MPa (psi)	7.8 (1,133)	7.8 (1,133)	7.6 (1,106)	7.3 (1,061)	6.9 (994)	6.3 (915)	5.9 (859)	5.4 (776)	
	Anchor category	-	-	3							
	Strength reduction factor	ϕ_{ws} ϕ_{wf} ϕ_{uw}	-	0.45							

For **SI**: 1 inch \equiv 25.4 mm, 1 lbf = 4.448 N, 1 psi = 0.006897 MPa.
 For **pound-inch** units: 1 mm = 0.03937 inches, 1 N = 0.2248 lbf, 1 MPa = 145.0 psi

¹Bond strength values correspond to concrete compressive strength $f'_c = 2,500$ psi (17.2 MPa). For concrete compressive strength, f'_c , between 2,500 psi (17.2 MPa) and 8,000 psi (55.2 MPa), the tabulated characteristic bond strength may be increased by a factor of $(f'_c / 2,500)^{0.1}$ [For SI: $(f'_c / 17.2)^{0.1}$]. See Section 4.1.4 of this report for bond strength determination.

²Bond strength values are for sustained loads including dead and live loads. For load combinations consisting of short-term loads only such as wind and seismic, bond strengths may be increased 40 percent.

³Values are for the following temperature range: maximum short term temperature = 130°F (55°C), maximum long term temperature = 110°F (43°C). Short term elevated concrete temperatures are those that occur over brief intervals, e.g., as a result of diurnal cycling. Long term concrete temperatures are roughly constant over significant periods of time.

⁴For structures assigned to Seismic Design Categories C, D, E or F, bond strength values must be multiplied by $\alpha_{N,seis} = 0.90$.



TABLE 13—STEEL DESIGN INFORMATION FOR CANADIAN METRIC REINFORCING BARS¹

DESIGN INFORMATION		Symbol	Units	Bar size				
				10 M	15 M	20 M	25 M	30 M
Nominal bar diameter		d	mm (in.)	11.3 (0.445)	16.0 (0.630)	19.5 (0.768)	25.2 (0.992)	29.9 (1.177)
Bar effective cross-sectional area		A_{se}	mm ² (in. ²)	100.3 (0.155)	201.1 (0.312)	298.6 (0.463)	498.8 (0.773)	702.2 (1.088)
CSA G30	Nominal strength as governed by steel strength	N_{sa}	kN (lb)	54.0 (12,175)	108.5 (24,408)	161.5 (36,255)	270.0 (60,548)	380.0 (85,239)
		V_{sa}	kN (lb)	32.5 (7,305)	65.0 (14,645)	97.0 (21,753)	161.5 (36,329)	227.5 (51,144)
	Reduction for seismic shear	$\alpha_{V,seis}$	-	0.70				
	Strength reduction factor for tension ²	ϕ	-	0.65				
	Strength reduction factor for shear ²	ϕ	-	0.60				

For **SI**: 1 inch \equiv 25.4 mm, 1 lbf = 4.448 N, 1 psi = 0.006897 MPa.
 For **pound-inch** units: 1 mm = 0.03937 inches, 1 N = 0.2248 lbf, 1 MPa = 145.0 psi

¹Values provided for common rod material types are based on specified strengths and calculated in accordance with ACI 318-19 Eq. (17.6.1.2) and Eq. (17.7.1.2b) or ACI 318-14 Eq. (17.4.1.2) and Eq. (17.5.1.2b), as applicable. Nuts and washers must be appropriate for the rod.

²The strength reduction factor applies when the load combinations from the IBC or ACI 318 are used and the requirements of ACI 318-19 17.5.3 or ACI 318-14 17.3.3, as applicable, are met.

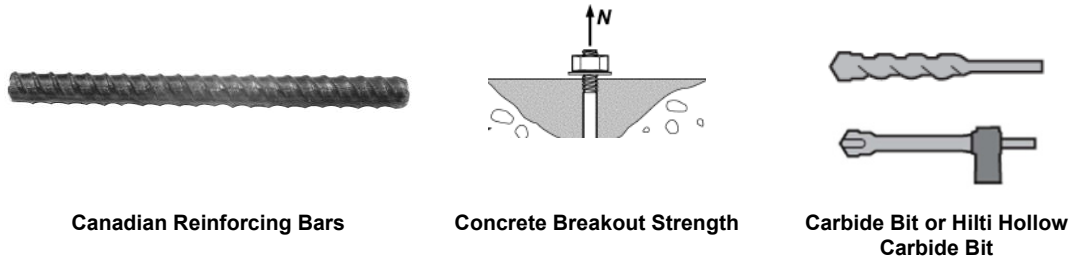

TABLE 14—CONCRETE BREAKOUT DESIGN INFORMATION FOR CANADIAN METRIC REINFORCING BARS IN HOLES DRILLED WITH A HAMMER DRILL AND CARBIDE BIT (OR HILTI HOLLOW CARBIDE DRILL BIT)¹

DESIGN INFORMATION	Symbol	Units	Bar size				
			10 M	15 M	20 M	25 M	30 M
Effectiveness factor for cracked concrete	$k_{c,cr}$	SI (in-lb)	7.1 (17)				
Effectiveness factor for uncracked concrete	$k_{c,uncr}$	SI (in-lb)	10 (24)				
Minimum embedment	$h_{ef,min}$	mm (in.)	60 (2.4)	80 (3.1)	90 (3.5)	101 (4.0)	120 (4.7)
Maximum embedment	$h_{ef,max}$	mm (in.)	226 (8.9)	320 (12.6)	390 (15.4)	504 (19.8)	598 (23.5)
Minimum bar spacing ³	s_{min}	mm (in.)	57 (2.2)	80 (3.1)	98 (3.8)	126 (5.0)	150 (5.9)
Minimum edge distance ³	c_{min}	mm (in.)	5d; or see Section 4.1.9 of this report for design with reduced minimum edge distances				
Minimum concrete thickness	h_{min}	mm (in.)	$h_{ef} + 30$ ($h_{ef} + 1\frac{1}{4}$)	$h_{ef} + 2d_o^{(4)}$			
Critical edge distance – splitting (for uncracked concrete)	c_{ac}	-	See Section 4.1.10 of this report.				
Strength reduction factor for tension, concrete failure modes, Condition B (supplemental reinforcement not present) ²	ϕ	-	0.65				
Strength reduction factor for shear, concrete failure modes, Condition B (supplemental reinforcement not present) ²	ϕ	-	0.70				

For **SI**: 1 inch \equiv 25.4 mm, 1 lbf = 4.448 N, 1 psi = 0.006897 MPa.
 For **pound-inch** units: 1 mm = 0.03937 inches, 1 N = 0.2248 lbf, 1 MPa = 145.0 psi

¹Additional setting information is described in Figure 7, Manufacturers Printed Installation Instructions (MPII).

²The strength reduction factor applies when the load combinations from the IBC or ACI 318 are used and the requirements of ACI 318-19 17.5.3 or ACI 318-14 17.3.3, as applicable, are met.

³For installations with 1³/₄-inch edge distance, refer to Section 4.1.9 of this report for spacing and maximum torque requirements.

⁴ d_o = hole diameter.

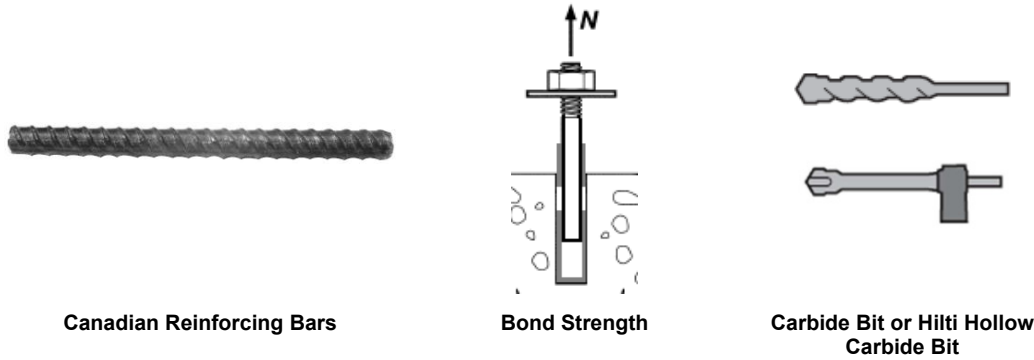

TABLE 15—BOND STRENGTH DESIGN INFORMATION FOR CANADIAN METRIC REINFORCING BARS IN HOLES DRILLED WITH A HAMMER DRILL AND CARBIDE BIT (OR HILTI HOLLOW CARBIDE DRILL BIT)^{1,2,3,4}

DESIGN INFORMATION		Symbol	Units	Bar size				
				10 M	15 M	20 M	25 M	30 M
Minimum embedment		$h_{ef,min}$	mm (in.)	60 (2.8)	80 (3.1)	90 (3.5)	101 (4.0)	120 (4.7)
Maximum embedment		$h_{ef,max}$	mm (in.)	226 (8.9)	320 (12.6)	390 (15.4)	504 (19.8)	598 (23.5)
Dry concrete	Characteristic bond strength in cracked concrete	$\tau_{k,cr}$	MPa (psi)	3.3 (476)	3.3 (476)	3.3 (476)	3.3 (476)	2.9 (416)
	Characteristic bond strength in uncracked concrete	$\tau_{k,uncr}$	MPa (psi)	8.8 (1,272)	8.3 (1,204)	8.0 (1,156)	7.6 (1,100)	7.3 (1,056)
	Anchor category	-	-	2				
	Strength reduction factor	ϕ_d	-	0.55				
Water saturated concrete, water-filled hole and underwater application	Characteristic bond strength in cracked concrete	$\tau_{k,cr}$	MPa (psi)	2.9 (424)	2.9 (420)	2.8 (405)	2.5 (360)	2.2 (319)
	Characteristic bond strength in uncracked concrete	$\tau_{k,uncr}$	MPa (psi)	7.8 (1,133)	7.3 (1,061)	6.8 (986)	6.1 (878)	5.5 (803)
	Anchor category	-	-	3				
	Strength reduction factor	ϕ_{ws} ϕ_{wf} ϕ_{uw}	-	0.45				

For SI: 1 inch \equiv 25.4 mm, 1 lbf = 4.448 N, 1 psi = 0.006897 MPa.

For pound-inch units: 1 mm = 0.03937 inches, 1 N = 0.2248 lbf, 1 MPa = 145.0 psi

¹Bond strength values correspond to concrete compressive strength $f'_c = 2,500$ psi (17.2 MPa). For concrete compressive strength, f'_c , between 2,500 psi (17.2 MPa) and 8,000 psi (55.2 MPa), the tabulated characteristic bond strength may be increased by a factor of $(f'_c / 2,500)^{0.1}$ [For SI: $(f'_c / 17.2)^{0.1}$]. See Section 4.1.4 of this report for bond strength determination.

²Bond strength values are for sustained loads including dead and live loads. For load combinations consisting of short-term loads only such as wind and seismic, bond strengths may be increased 40 percent.

³Values are for the following temperature range: maximum short term temperature = 130°F (55°C), maximum long term temperature = 110°F (43°C). Short term elevated concrete temperatures are those that occur over brief intervals, e.g., as a result of diurnal cycling. Long term concrete temperatures are roughly constant over significant periods of time.

⁴For structures assigned to Seismic Design Categories C, D, E or F, bond strength values must be multiplied by $\alpha_{N,seis} = 0.90$.

TABLE 16—DEVELOPMENT LENGTH FOR U.S. CUSTOMARY UNIT REINFORCING BARS IN HOLES DRILLED WITH A HAMMER DRILL AND CARBIDE BIT (OR HILTI HOLLOW CARBIDE BIT) ^{1,2,5,6}

DESIGN INFORMATION	Symbol	Criteria Section of Reference Standard	Units	Bar Size							
				#3	#4	#5	#6	#7	#8	#9	#10
Nominal reinforcing bar diameter	d_b	ASTM A615/A706	in. (mm)	0.375 (9.5)	0.500 (12.7)	0.625 (15.9)	0.750 (19.1)	0.875 (22.2)	1.000 (25.4)	1.128 (28.7)	1.270 (32.3)
Nominal bar area	A_b	ASTM A615/A706	in ² (mm ²)	0.11 (71)	0.20 (129)	0.31 (199)	0.44 (284)	0.60 (387)	0.79 (510)	1.00 (645)	1.27 (819)
Development length for $f_y = 60$ ksi and $f_c = 2,500$ psi (normal weight concrete) ^{3,4}	l_d	ACI 318-19 25.4.2.4 ACI 318-14 25.4.2.3	in. (mm)	12.0 (305)	14.4 (366)	18.0 (457)	21.6 (549)	31.5 (800)	36.0 (914)	40.6 (1031)	45.7 (1161)
Development length for $f_y = 60$ ksi and $f_c = 4,000$ psi (normal weight concrete) ^{3,4}	l_d	ACI 318-19 25.4.2.4 ACI 318-14 25.4.2.3	in. (mm)	12.0 (305)	12.0 (305)	14.2 (361)	17.1 (434)	24.9 (633)	28.5 (723)	32.1 (815)	36.1 (918)

For **SI**: 1 inch = 25.4 mm, 1 lbf = 4.448 N, 1 psi = 0.006897 Mpa
 For **pound-inch** units: 1 mm = 0.03937 inches, 1 N = 0.2248 lbf, 1 Mpa = 145.0 psi

¹Development lengths valid for static, wind, and earthquake loads (SDC A and B).
²Development lengths in SDC C through F must comply with ACI 318 (-19 or -14) Chapter 18 and Section 4.2.4 of this report. The value of f_c used to calculate development lengths shall not exceed 2,500 psi for post-installed reinforcing bar applications in SDCs C, D, E, and F.
³For all-lightweight concrete, increase development length by 33% unless the provisions of ACI 318-19 25.4.2.5 or ACI 318-14 25.4.2.4 are met to permit $\lambda > 0.75$. For sand-lightweight concrete, increase development length by 18% unless the provisions of ACI 318-19 25.4.2.5 or ACI 318-14 25.4.2.4 are met to permit $\lambda > 0.85$.
⁴ $\left(\frac{c_b + K_{tr}}{d_b}\right) = 2.5$, $\psi_t = 1.0$, $\psi_e = 1.0$, $\psi_s = 0.8$ for $d_b \leq \#6$, 1.0 for $d_b > \#6$
⁵Calculations may be performed for other steel grades per ACI 318 (-19 or -14) Chapter 25.
⁶Minimum development length shall not be less than 12 in (305 mm) per ACI 318 (-19 or -14) Section 25.4.2.1.

TABLE 17—DEVELOPMENT LENGTH FOR EU METRIC REINFORCING BARS IN HOLES DRILLED WITH A HAMMER DRILL AND CARBIDE BIT (OR HILTI HOLLOW CARBIDE BIT) ^{1,2,5,6}

DESIGN INFORMATION	Symbol	Criteria Section of Reference Standard	Units	Bar Size						
				8	10	12	16	20	25	32
Nominal reinforcing bar diameter	d_b	BS4449: 2005	mm (in.)	8 (0.315)	10 (0.394)	12 (0.472)	16 (0.630)	20 (0.787)	25 (0.984)	32 (1.260)
Nominal bar area	A_b	BS 4449: 2005	mm ² (in ²)	50.3 (0.08)	78.5 (0.12)	113.1 (0.18)	201.1 (0.31)	314.2 (0.49)	490.9 (0.76)	804.2 (1.25)
Development length for $f_y = 72.5$ ksi and $f_c = 2,500$ psi (normal weight concrete) ^{3,4}	l_d	ACI 318-19 25.4.2.4 ⁷ ACI 318-14 25.4.2.3	mm (in.)	305 (12.0)	348 (13.7)	417 (16.4)	556 (21.9)	871 (34.3)	1087 (42.8)	1392 (54.8)
Development length for $F_y = 72.5$ ksi and $f_c = 4,000$ psi (normal weight concrete) ^{3,4}	l_d	ACI 318-19 25.4.2.4 ⁷ ACI 318-14 25.4.2.3	mm (in.)	305 (12.0)	305 (12.0)	330 (13.0)	439 (17.3)	688 (27.1)	859 (33.8)	1100 (43.3)

For **SI**: 1 inch = 25.4 mm, 1 lbf = 4.448 N, 1 psi = 0.006897 Mpa
 For **pound-inch** units: 1 mm = 0.03937 inches, 1 N = 0.2248 lbf, 1 Mpa = 145.0 psi

¹Development lengths valid for static, wind, and earthquake loads (SDC A and B).
²Development lengths in SDC C through F must comply with ACI 318 (-19 or -14) Chapter 18 and Section 4.2.4 of this report. The value of f_c used to calculate development lengths shall not exceed 2,500 psi for post-installed reinforcing bar applications in SDCs C, D, E, and F.
³For all-lightweight concrete, increase development length by 33% unless the provisions of ACI 318-19 25.4.2.5 (ACI 318-14 25.4.2.4) are met to permit $\lambda > 0.75$. For sand-lightweight concrete, increase development length by 18% unless the provisions of ACI 318-19 25.4.2.5 (ACI 318-14 25.4.2.4) are met to permit $\lambda > 0.85$.
⁴ $\left(\frac{c_b + K_{tr}}{d_b}\right) = 2.5$, $\psi_t = 1.0$, $\psi_e = 1.0$, $\psi_s = 0.8$ for $d_b < 20$ mm, 1.0 for $d_b \geq 20$ mm
⁵Calculations may be performed for other steel grades per ACI 318 (-19 or -14) Chapter 25.
⁶Minimum development length shall not be less than 12 in (305 mm) per ACI 318 (-19 or -14) Section 25.4.2.1.
⁷ l_d must be increased by 9.5% to account for ψ_g in ACI 318-19 25.4.2.4. ψ_g has been interpolated from Table 25.4.2.5 of ACI 318-19 for $f_y = 72.5$ ksi.

TABLE 18—DEVELOPMENT LENGTH FOR CANADIAN REINFORCING BARS IN HOLES DRILLED WITH A HAMMER DRILL AND CARBIDE BIT (OR HILTI HOLLOW CARBIDE BIT) ^{1,2,5,6}

DESIGN INFORMATION	Symbol	Criteria Section of Reference Standard	Units	Bar Size				
				10M	15M	20M	25M	30M
Nominal reinforcing bar diameter	d_b	CAN/CSA-G30.18 Gr.400	mm (in.)	11.3 (0.445)	16.0 (0.630)	19.5 (0.768)	25.2 (0.992)	29.9 (1.177)
Nominal bar area	A_b	CAN/CSA-G30.18 Gr.400	mm ² (in ²)	100.3 (0.16)	201.1 (0.31)	298.6 (0.46)	498.8 (0.77)	702.2 (1.09)
Development length for $f_y = 58$ ksi and $f_c = 2,500$ psi (normal weight concrete) ^{3,4}	l_d	ACI 318-19 25.4.2.4 ACI 318-14 25.4.2.3	mm (in.)	315 (12.4)	445 (17.5)	678 (26.7)	876 (34.5)	1,041 (41.0)
Development length for $F_y = 58$ ksi and $f_c = 4,000$ psi (normal weight concrete) ^{3,4}	l_d	ACI 318-19 25.4.2.4 ACI 318-14 25.4.2.3	mm (in.)	305 (12.0)	353 (13.9)	536 (21.1)	693 (27.3)	823 (32.4)

For **SI**: 1 inch = 25.4 mm, 1 lbf = 4.448 N, 1 psi = 0.006897 Mpa
 For **pound-inch** units: 1 mm = 0.03937 inches, 1 N = 0.2248 lbf, 1 Mpa = 145.0 psi

¹Development lengths valid for static, wind, and earthquake loads (SDC A and B).
²Development lengths in SDC C through F must comply with ACI 318 (-19 or -14) Chapter 18 and Section 4.2.4 of this report. The value of f_c used to calculate development lengths shall not exceed 2,500 psi for post-installed reinforcing bar applications in SDCs C, D, E, and F.
³For all-lightweight concrete, increase development length by 33% unless the provisions of ACI 318-19 25.4.2.5 (ACI 318-14 25.4.2.4) are met to permit $\lambda > 0.75$. For sand-lightweight concrete, increase development length by 17.6% unless the provisions of ACI 318-19 25.4.2.5 (ACI 318-14 25.4.2.4) are met to permit $\lambda > 0.85$.
⁴ $\left(\frac{c_b + K_{tr}}{d_b}\right) = 2.5, \psi_t=1.0, \psi_e=1.0, \psi_s=0.8$ for $d_b < 20$ mm, 1.0 for $d_b \geq 20$ mm
⁵Calculations may be performed for other steel grades per ACI 318 (-19 or -14) Chapter 25.
⁶Minimum development length shall not be less than 12 in (305 mm) per ACI 318 (-19 or -14) Section 25.4.2.1.



HILTI HIT-RE 100 FOIL PACK AND MIXING NOZZLE



HILTI DISPENSER



ANCHORING ELEMENTS



HILTI TE-CD OR TE-YD HOLLOW CARBIDE DRILL BIT

FIGURE 6—HILTI HIT-RE 100 ANCHORING SYSTEM

HILTI

Hilti HIT-RE 100

Instructions for use en

Instrucciones de uso es

Mode d'emploi fr

Instruções de utilização pt

Danger

Contains epoxy constituents. May produce an allergic reaction.(A)

Contains: reaction product: bisphenol-A-(epichlorohydrin) epoxy resin MW ≤ 700 (A), reaction product: bisphenol-F epichlorohydrin resin MW≤700 (A), m-Xylenediamine,(B)

Causes severe skin burns and eye damage.(B)

May cause an allergic skin reaction.(A,B)

Toxic to aquatic life with long lasting effects.(A)

ICC-ES ESR - 3829

en Hammer drilling	Hollow drill bit
es Taladrado con martillo	Taladro con broca hueca y aspiración
fr Perçage avec percussion	Foret creux
pt Perfurar de martelo	Broca de coroa oca

en Working time	Initial curing time	Curing time
es Tiempo de tratamiento	Resistencia de montaje	Tiempo de fragu
fr Temps de manipulation	Stabilité du montage	Temps de durcis
pt Tempo de trabalho	Resistência de montagem	Tempo de cura i

en Dry concrete	Water saturated concrete	Waterfilled borehole in concrete	Submerged borehole in concrete
es Hormigón seco	Hormigón saturado de agua	Taladro lleno de agua en hormigón	Taladro sumergido en hormigón
fr Béton sec	Béton saturé d'eau	Trou dans le béton rempli d'eau	Trou dans le béton immergé
pt Betão seco	Betão saturado de água	Furo em betão cheio de água	Furo debaixo de água em betão

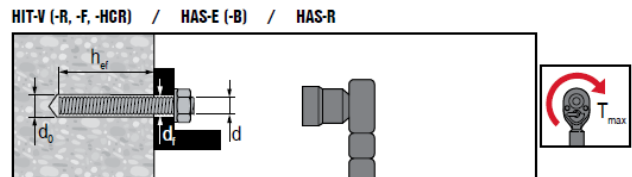

HAS / HIT-V

Ø d [inch]	Ø d ₀ [inch]	h _{ef} [inch]	Ø d ₁ [inch]	T _{max} [ft-lb]	T _{max} [Nm]
3/8	7/16	2 3/8... 7 1/2	7/16	15	20
1/2	9/16	2 3/4... 10	9/16	30	41
5/8	3/4	3 1/8... 12 1/2	11/16	60	81
3/4	7/8	3 1/2... 15	13/16	100	136
7/8	1	3 1/2... 17 1/2	15/16	125	169
1	1 1/8	4... 20	1 1/8	150	203
1 1/4	1 3/8	5... 25	1 3/8	200	271

en Threaded rod	Rebar	Uncracked concrete	Cracked concrete
es Tige fileté	Armature metálica	Béton non lézardé	Béton lézardé
fr Varilla roscada	Barras corrugadas para armado	Hormigón no fisurado	Hormigón fisurado
pt Barra roscada	Ferros de armadura	Betão não fissurado	Betão fissurado

HIT-V

Ø d [mm]	Ø d ₀ [mm]	h _{ef} [mm]	Ø d ₁ [mm]	T _{max} [Nm]
M8	10	60...160	9	10
M10	12	60...200	12	20
M12	14	70...240	14	40
M16	18	80...320	18	80
M20	22	90...400	22	150
M24	28	96...480	26	200
M27	30	108...540	30	270
M30	35	120...600	33	300

1 inch = 25.4 mm

FIGURE 7—MANUFACTURER'S PRINTED INSTALLATION INSTRUCTIONS (MPII)

Rebar

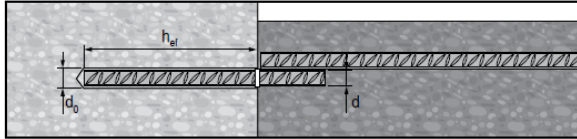

US Rebar

d	Ø d ₀ [inch]	h _{ef} [inch]
#3	1/2	2 3/8...22 1/2
#4	5/8	2 3/4...30
#5	3/4	3 1/8...37 1/2
#6	7/8	3 1/2...15
	1	15...45
#7	1	3 1/2...17 1/2
	1 1/8	17 1/2...52 1/2
#8	1 1/8	4...20
	1 1/4	20...60
#9	1 3/8	4 1/2...67 1/2
#10	1 1/2	5...75
#11	1 3/4	5 1/2...82 1/2

CA Rebar

d	Ø d ₀ [inch]	h _{ef} [mm]
10 M	9/16	70...678
15 M	3/4	80...960
20 M	1	90...1170
25 M	1 1/4 (32 mm)	101...1512
30 M	1 1/2	120...1794

EU Rebar

Ø d [mm]	Ø d ₀ [mm]	h _{ef} [mm]
8	12	60...480
10	14	60...600
12	16	70...720
14	18	75...840
16	20	80...960
18	22	85...1080
20	25	90...1200
22	28	95...1320
24	32	96...1440
25	32	100...1500
26	35	104...1560
28	35	112...1680
30	37	120...1800
32	40	128...1920

[°C]	[°F]	t _{work}	t _{cure, ini}	t _{cure, full}
5	41	2 1/2 h	≥ 18 h	≥ 72 h
10	50	2 h	≥ 12 h	≥ 48 h
15	59	1 1/2 h	≥ 8 h	≥ 24 h
20	68	30 min	≥ 6 h	≥ 12 h
30	86	20 min	≥ 4 h	≥ 8 h
40	104	12 min	≥ 2 h	≥ 4 h

Rebar - h_{ef} ≥ 20d

		h _{ef}		
HDM, HDE, HIT-P 8000D	≤ US #5	12 1/2 ... 37 1/2 [inch]	41°F ... 104°F	41°F ... 104°F
	≤ EU 16mm	320 ... 960 [mm]	5°C ... 40°C	5°C ... 40°C
	≤ CAN 15M	320 ... 960 [mm]		
HDE, HIT-P 8000D	≤ US #7	17 1/2 ... 52 1/2 [inch]	41°F ... 104°F	41°F ... 104°F
	≤ EU 20mm	400 ... 1200 [mm]	5°C ... 40°C	5°C ... 40°C
	≤ CAN 20M	390 ... 1170 [mm]		
HIT-P 8000D	≤ US #10	25 ... 75 [inch]	41°F ... 104°F	41°F ... 104°F
	≤ EU 32mm	640 ... 1920 [mm]	5°C ... 40°C	5°C ... 40°C
	≤ CAN 30M	598 ... 1794 [mm]		

		h _{ef}		
HDM, HDE, HIT-P 8000D	≤ US #5	12 1/2 ... 37 1/2 [inch]	41°F ... 104°F	41°F ... 104°F
	≤ EU 16mm	320 ... 960 [mm]	5°C ... 40°C	5°C ... 40°C
	≤ CAN 15M	320 ... 960 [mm]		
HDE, HIT-P 8000D	≤ US #7	17 1/2 ... 39 3/8 [inch]	41°F ... 104°F	41°F ... 104°F
	≤ EU 20mm	400 ... 1000 [mm]	5°C ... 40°C	5°C ... 40°C
	≤ CAN 20M	390 ... 1000 [mm]		

Ø	Ø	HAS/HIT-V	Rebar	HIT-RB	HIT-SZ	HIT-DL	HIT-OHC
d ₀ [inch]	d ₀ [inch]	d [inch]		[inch]	[inch]	[inch]	Art. No.
7/16	-	3/8	-	7/16	-	-	387551
1/2	1/2	-	#3	1/2	1/2	1/2	
9/16	9/16	1/2	10M	9/16	9/16	9/16	
5/8	5/8	-	#4	5/8	5/8	5/8	
3/4	3/4	5/8	15M #5	3/4	3/4	3/4	
7/8	7/8	3/4	#6	7/8	7/8	7/8	387552
1	1	7/8	20M #7	1	1	1	
1 1/8	1 1/8	1	#8	1 1/8	1 1/8	1	
1 1/4	-	-	25M	1 1/4	1 1/4	1	
1 3/8	-	1 1/4	#9	1 3/8	1 3/8	1 3/8	
1 1/2	-	-	30M #10	1 1/2	1 1/2	1 3/8	

HIT-DL: h_{ef} > 10" HIT-RB: h_{ef} > 20 x d

HIT-RE-M	HIT-OHW
Art. No.	Art. No.
337111	387550

Ø	h _{ef}	Art. No. 381215	≥ 6 bar/90 psi @ 6 m³/h
d ₀ [inch]	[inch]		≥ 140 m³/h / ≥ 82 CFM
7/16" ... 1 1/8"	2 3/8" ... 20"	✓	
1 1/4" ... 1 1/2"	4" ... 25"	-	

Ø	Ø	HIT-V	Rebar	HIT-RB	HIT-SZ	HIT-DL	HIT-OHC
d ₀ [mm]	d ₀ [mm]	d [mm]		[mm]	[mm]		Art. No.
10	-	8	-	10	-	-	387551
12	12	10	8	12	12	12	
14	14	12	10	14	14	14	
16	16	-	12	16	16	16	
18	18	16	14	18	18	18	
20	20	-	16	20	20	20	387552
22	22	20	18	22	22	20	
25	25	-	20	25	25	25	
28	28	24	22	28	28	25	
30	-	27	-	30	30	25	
32	32	-	24/25	32	32	32	
35	35	30	26/28	35	35	32	
37	-	-	30	37	37	32	
40	-	-	32	40	40	32	

HIT-DL: h_{ef} > 250 mm HIT-RB: h_{ef} > 20 x d

HIT-RE-M	HIT-OHW
Art. No.	Art. No.
337111	387550

Ø	h _{ef}	Art. No. 381215	≥ 6 bar/90 psi
d ₀ [mm]	[mm]		≥ 140 m³/h
10...32	60...500	✓	
35...40	100...640	-	

FIGURE 7—MANUFACTURER'S PRINTED INSTALLATION INSTRUCTIONS (MPII) (CONTINUED)

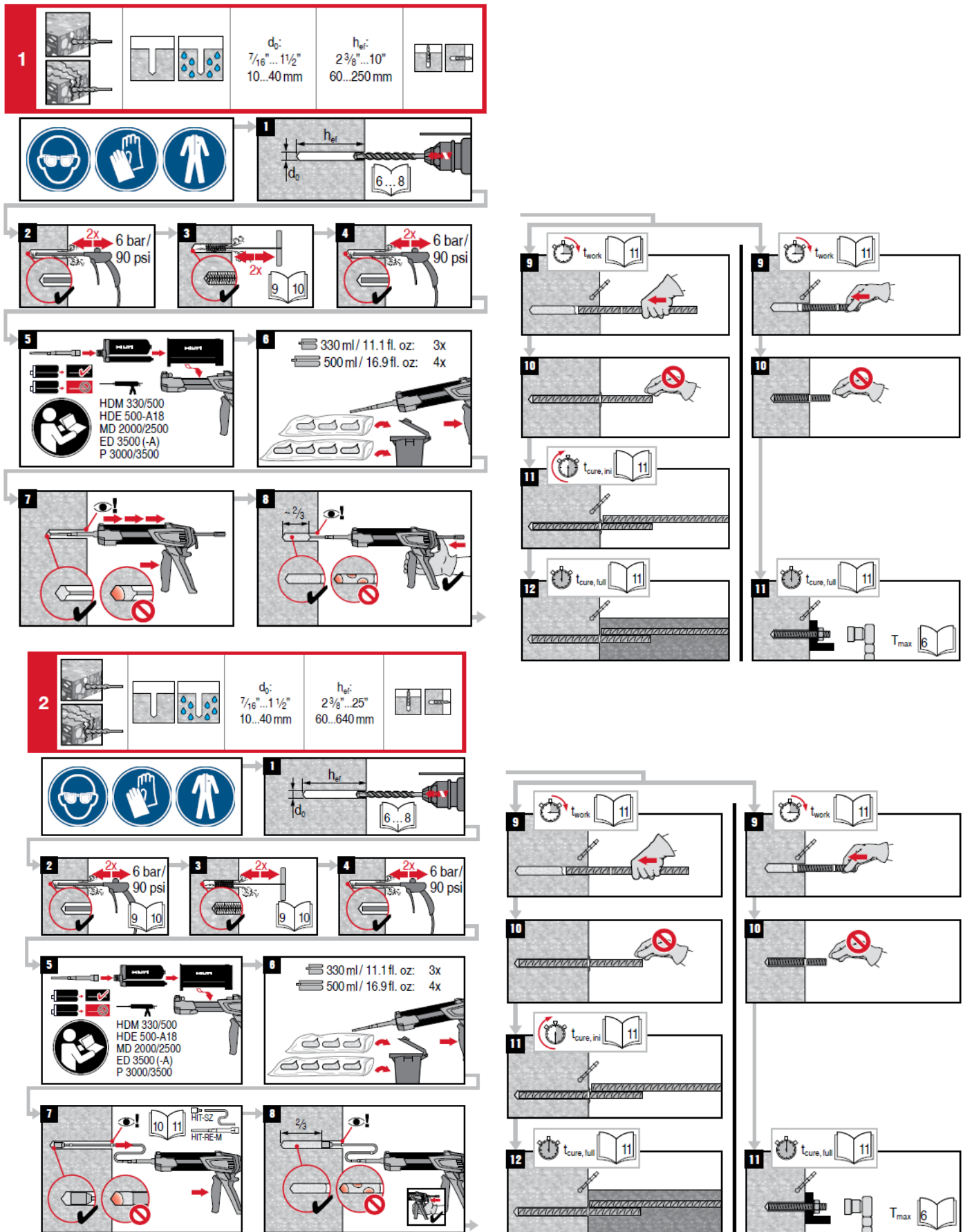

FIGURE 7—MANUFACTURER'S PRINTED INSTALLATION INSTRUCTIONS (MPII) (CONTINUED)

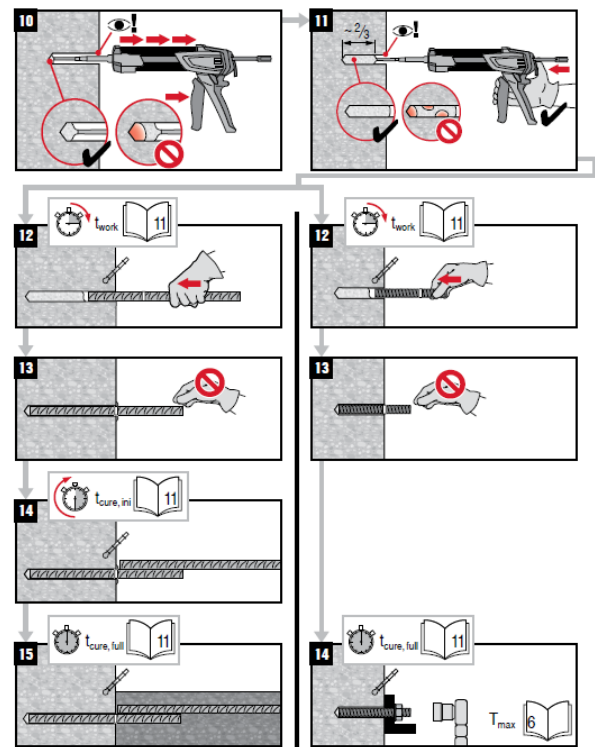
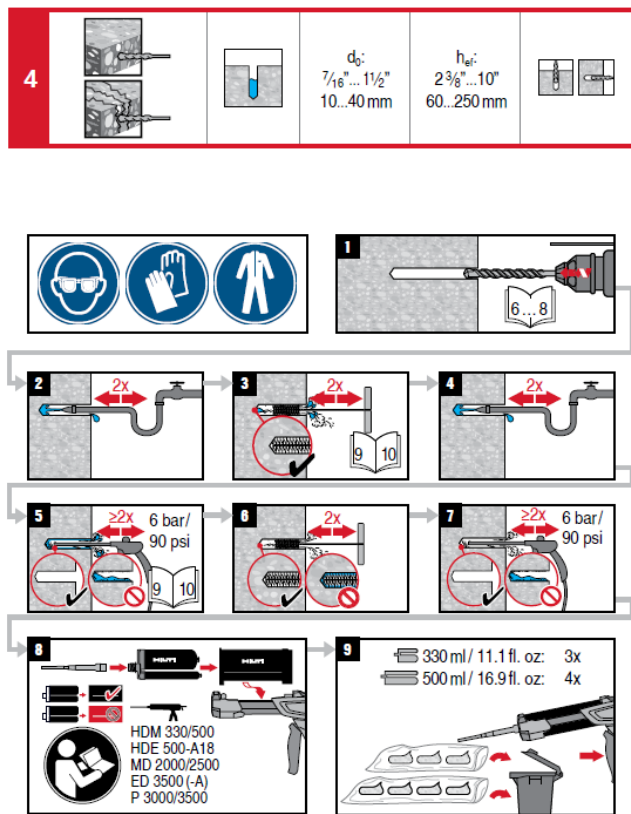
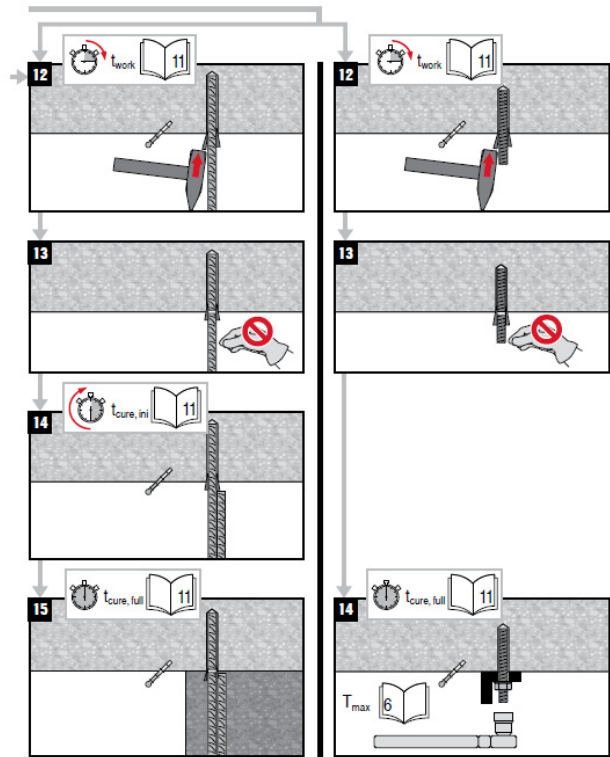
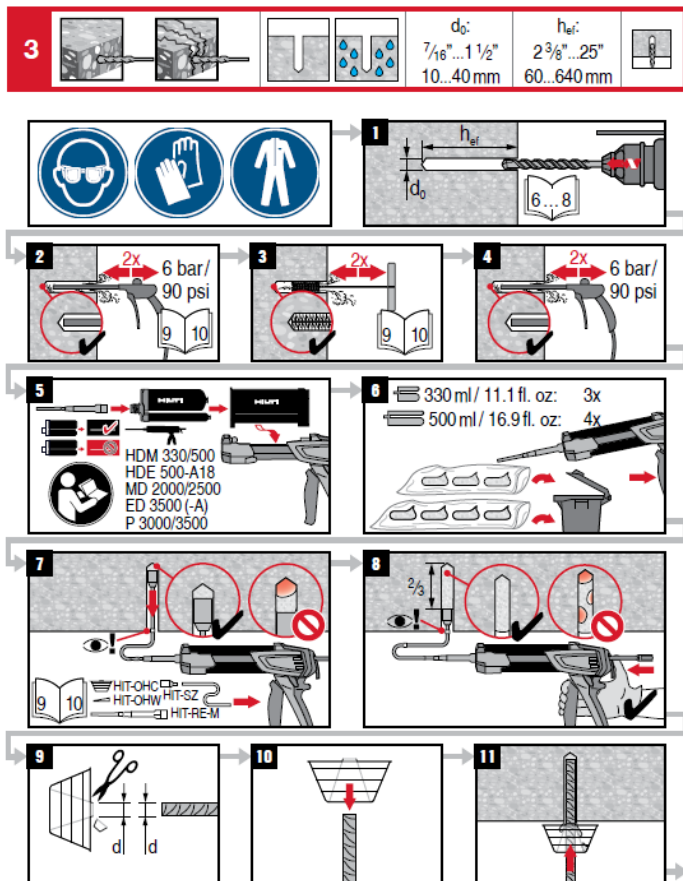

FIGURE 7—MANUFACTURER'S PRINTED INSTALLATION INSTRUCTIONS (MPII) (CONTINUED)

5

d_0 : 7/16" ... 1 1/2"
10...40 mm

h_{ef} : 2 3/8" ... 25"
60...640 mm

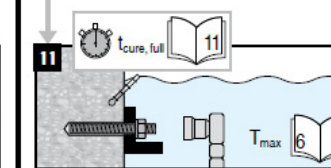
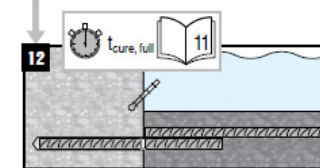
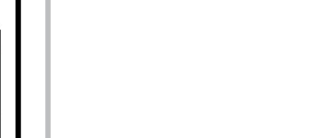
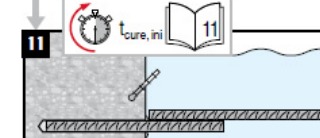
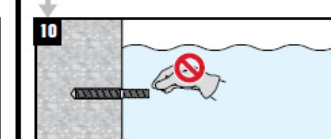
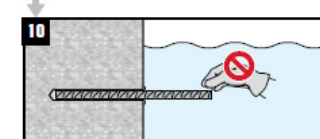
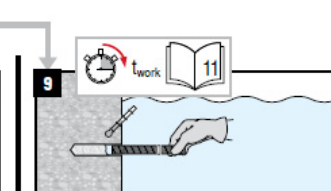
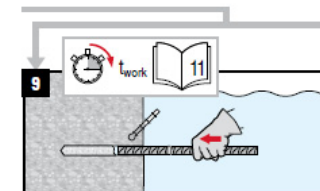
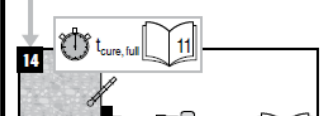
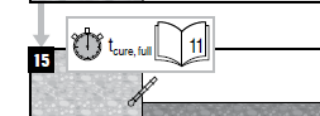
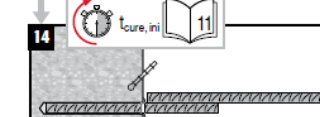
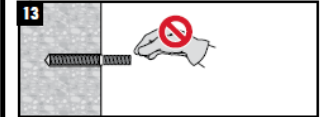
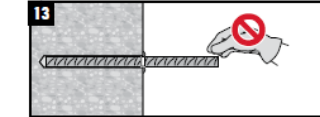
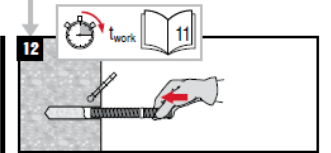
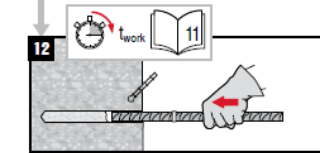
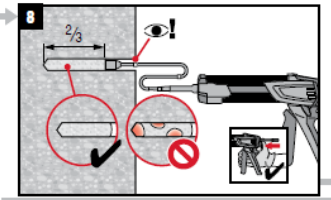
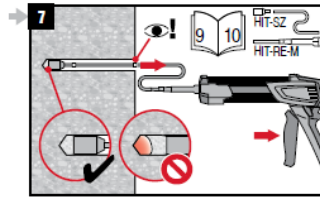
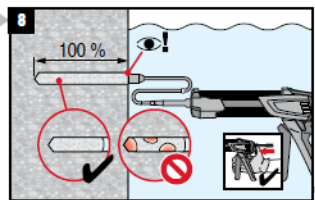
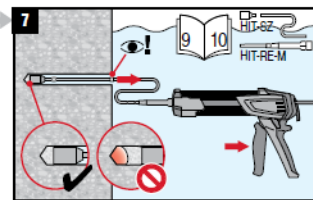
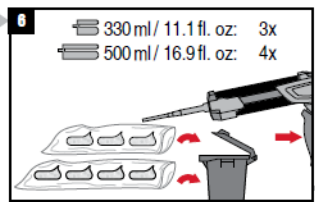
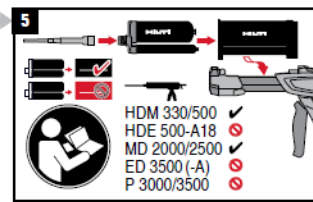
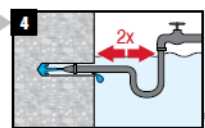
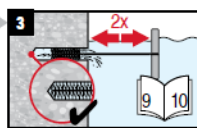
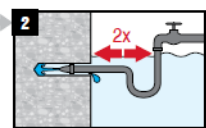
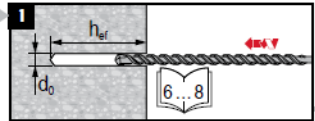
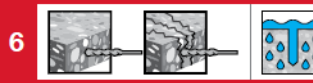
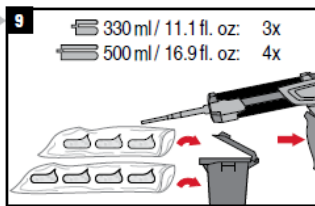
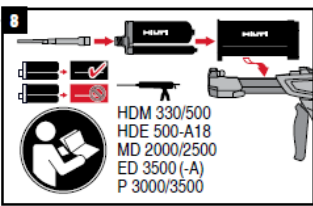
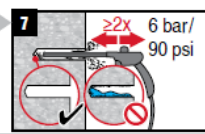
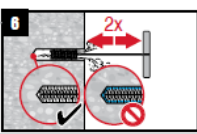
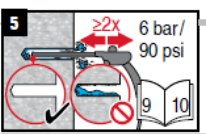
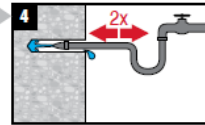
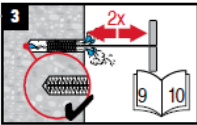
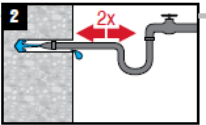
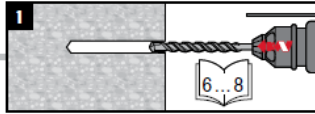

FIGURE 7—MANUFACTURER'S PRINTED INSTALLATION INSTRUCTIONS (MPII) (CONTINUED)

7			$d_0:$	$h_{ef}:$	
			$\frac{9}{16} \dots 1 \frac{1}{8}''$ 14...32 mm	$2 \frac{3}{8} \dots 10''$ 60...250 mm	

2

 HDM 330/500
 HDE 500-A18

3

 330 ml / 11.1 fl. oz.: 3x
 500 ml / 16.9 fl. oz.: 4x

4

5

6

7

8

9

8			$d_0:$	$h_{ef}:$	
			$\frac{9}{16} \dots 1 \frac{1}{8}''$ 14...32 mm	$2 \frac{3}{8} \dots 25''$ 60...640 mm	

2

 HDM 330/500
 HDE 500-A18

3

 330 ml / 11.1 fl. oz.: 3x
 500 ml / 16.9 fl. oz.: 4x

4

5

6

7

8

9

FIGURE 7—MANUFACTURER'S PRINTED INSTALLATION INSTRUCTIONS (MPII) (CONTINUED)

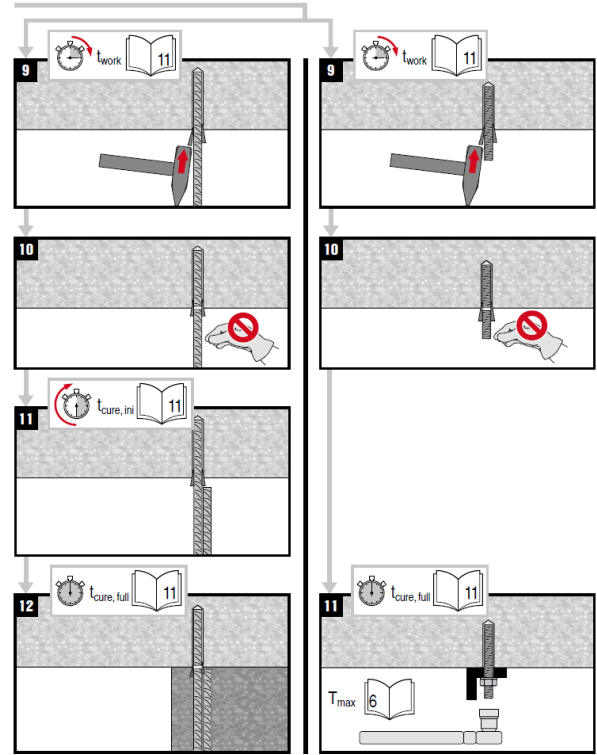
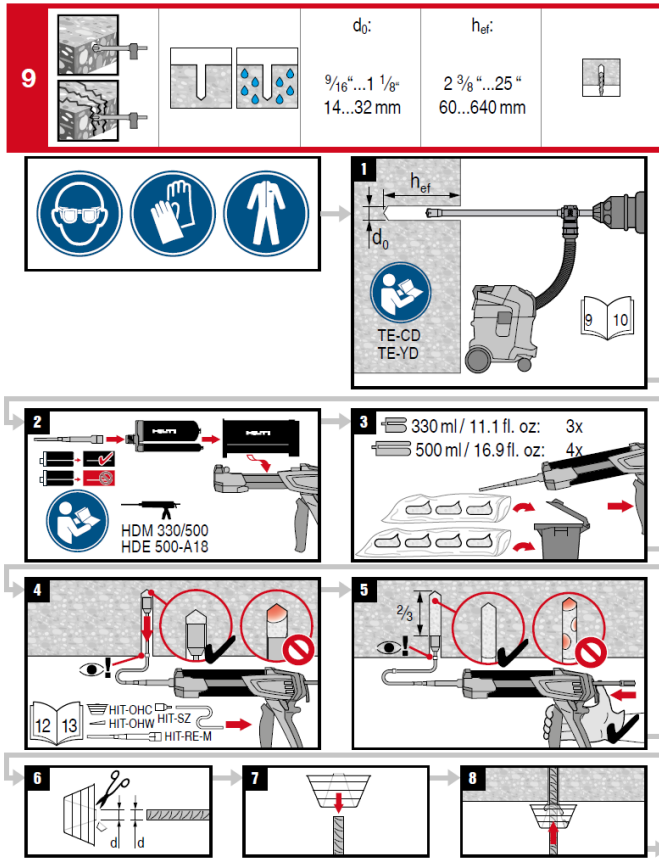

Adhesive anchoring system for rebar and anchor fastenings in concrete

- Prior to use of product, follow the instructions for use and the legally obligated safety precautions.
- See the Safety Data Sheet for this product.

Hilti HIT-RE 100
 Contains epoxy constituents. May produce an allergic reaction. (A)
Contains: reaction product: bisphenol-A-(epichlorohydrin) epoxy resin MW ≤ 700 (A), reaction product: bisphenol-F epichlorohydrin resin MWs700 (A), m-xylenediamine. (B)

Danger

(B)	(A,B)	(A)
H314	H317	H411
Causes severe skin burns and eye damage. (B)		
May cause an allergic skin reaction. (A,B)		
Toxic to aquatic life with long lasting effects. (A)		
P280	Wear protective gloves/protective clothing/eye protection/face protection.	
P260	Do not breathe vapours.	
P303+P361+P353	IF ON SKIN (or hair): Remove/Take off immediately all contaminated clothing. Rinse skin with water/shower.	
P305+P351+P338	IF IN EYES: Rinse cautiously with water for several minutes. Remove contact lenses, if present and easy to do. Continue rinsing.	
P333+P313	If skin irritation or rash occurs: Get medical advice/attention.	
P337+P313	If eye irritation persists: Get medical advice/attention.	

Recommended protective equipment:

- **Eye protection:** Tightly sealed safety glasses e.g.: #02065449 Safety glasses PP EY-CA NCH clear; #02065591 Goggles PP EY-HA R HC/AF clear;
 - **Protective gloves:** EN 374 ; Material of gloves: Nitrile rubber, NBR
- Avoid direct contact with the chemical/ the product/ the preparation by organizational measures.
Final selection of appropriate protective equipment is in the responsibility of the user

Disposal considerations

Empty packs:

- Leave the Mixer attached and dispose of via the local Green Dot collecting system or EAK waste material code 15 01 02 plastic packaging.

Full or partially emptied packs:

- dispose of as special waste in accordance with official regulations.
 - EAK waste material code: 20 01 27* paint, inks, adhesives and resins containing dangerous substances.
 - or waste material code: EAK 08 04 09* waste adhesives and sealants containing organic solvents or other dangerous substances.

Content:	330 ml / 11.1 fl.oz	500 ml / 16.9 fl.oz
Weight:	480 g / 16.9 oz	727 g / 25.6 oz

Warranty: Refer to standard Hilti terms and conditions of sale for warranty information.

Failure to observe these installation instructions, use of non-Hilti anchors, poor or questionable concrete conditions, or unique applications may affect the reliability or performance of the fastenings.

Product Information

- Always keep this instruction for use together with the product.
- Ensure that the instruction for use is with the product when it is given to other persons.
- **Safety Data Sheet:** Review the SDS before use.
- **Check expiration date:** See expiration date imprint on foil pack manifold (month/year). Do not use expired product.
- **Foil pack temperature during usage:** +5 °C to 40 °C / 41 °F to 104 °F.
- **Conditions for transport and storage:** Keep in a cool, dry and dark place between +5 °C to 25 °C / 41 °F to 77 °F.
- For any application not covered by this document / beyond values specified, please contact Hilti.
- **Partly used foil packs must be used up within 4 weeks.** Leave the mixer attached on the foil pack manifold and store under the recommended storage conditions. If reused, attach a new mixer and discard the initial quantity of anchor adhesive.

WARNING

- ! **Improper handling may cause mortar splashes. Eye contact with mortar may cause irreversible eye damage!**
 - Always wear lightly sealed safety glasses, gloves and protective clothes before handling the mortar
 - Never start dispensing without a mixer properly screwed on.
 - Attach a new mixer prior to dispensing a new foil pack (snug fit).
 - Caution! Never remove the mixer while the foil pack system is under pressure. Press the release button of the dispenser to avoid mortar splashing.
 - Use only the type of mixer supplied with the adhesive. Do not modify the mixer in any way.
 - Never use damaged foil packs and/or damaged or unclear foil pack holders.
- ! **Poor load values / potential failure of fastening points due to inadequate borehole cleaning. The boreholes must be dry and free of debris, dust, water, ice, oil, grease and other contaminants prior to adhesive injection.**
 - For blowing out the borehole - blow out with oil free air until return air stream is free of noticeable dust.
 - For flushing the borehole - flush with water line pressure until water runs clear.
 - Important! Remove all water from the borehole and blow out with oil free compressed air until borehole is completely dried before mortar injection (not applicable to hammer drilled hole in underwater application).
- ! **Ensure that boreholes are filled from the back of the boreholes without forming air voids.**
 - If necessary, use the accessories / extensions to reach the back of the borehole.
 - For overhead applications use the overhead accessories HIT-SZ / IP and take special care when inserting the fastening element. Excess adhesive may be forced out of the borehole. Make sure that no mortar drips onto the installer.
 - If a new mixer is installed onto a previously-opened foil pack, the first trigger pulls must be discarded.
 - A new mixer must be used for each new foil pack.

FIGURE 7—MANUFACTURER’S PRINTED INSTALLATION INSTRUCTIONS (MPII) (CONTINUED)

DIVISION: 03 00 00—CONCRETE

Section: 03 16 00—Concrete Anchors

DIVISION: 05 00 00—METALS

Section: 05 05 19—Post-Installed Concrete Anchors

REPORT HOLDER:

HILTI, INC.

EVALUATION SUBJECT:

HILTI HIT-RE 100 ADHESIVE ANCHORS AND POST INSTALLED REINFORCING BAR CONNECTIONS IN CRACKED AND UNCRACKED CONCRETE

1.0 REPORT PURPOSE AND SCOPE

Purpose:

The purpose of this evaluation report supplement is to indicate that the Hilti HIT-RE 100 Adhesive Anchoring System and Post-Installed Reinforcing Bar System, described in ICC-ES evaluation report [ESR-3829](#), have also been evaluated for compliance with the codes noted below as adopted by Los Angeles Department of Building and Safety (LADBS).

Applicable code editions:

- 2020 *City of Los Angeles Building Code* (LABC)
- 2020 *City of Los Angeles Residential Code* (LARC)

2.0 CONCLUSIONS

The Hilti HIT-RE 100 Adhesive Anchoring System and Post-Installed Reinforcing Bar System, described in Sections 2.0 through 7.0 of the evaluation report [ESR-3829](#), comply with LABC Chapter 19, and LARC, and are subject to the conditions of use described in this report.

3.0 CONDITIONS OF USE

The Hilti HIT-RE 100 Adhesive Anchoring System and Post-Installed Reinforcing Bar System described in this evaluation report supplement must comply with all of the following conditions:

- All applicable sections in the evaluation report [ESR-3829](#).
- The design, installation, conditions of use and labeling of the anchors are in accordance with the 2018 *International Building Code*® (IBC) provisions noted in the evaluation report [ESR-3829](#).
- The design, installation and inspection are in accordance with additional requirements of LABC Chapters 16 and 17, as applicable.
- Under the LARC, an engineered design in accordance with LARC Section R301.1.3 must be submitted.
- The allowable and strength design values listed in the evaluation report and tables are for the connection of the anchors to the concrete. The connection between the anchors and the connected members shall be checked for capacity (which may govern).
- For use in wall anchorage assemblies to flexible diaphragm, anchors shall be designed per the requirements of City of Los Angeles Information Bulletin P/BC 2020-071.

This supplement expires concurrently with the evaluation report, reissued April 2022 and revised February 2023.

DIVISION: 03 00 00—CONCRETE

Section: 03 16 00—Concrete Anchors

DIVISION: 05 00 00—METALS

Section: 05 05 19—Post-Installed Concrete Anchors

REPORT HOLDER:

HILTI, INC.

EVALUATION SUBJECT:

HILTI HIT-RE 100 ADHESIVE ANCHORS AND POST INSTALLED REINFORCING BAR CONNECTIONS IN CRACKED AND UNCRACKED CONCRETE

1.0 REPORT PURPOSE AND SCOPE

Purpose:

The purpose of this evaluation report supplement is to indicate that the Hilti HIT-RE 100 Adhesive Anchoring System, described in ICC-ES evaluation report ESR-3829, has also been evaluated for compliance with the codes noted below.

Applicable code editions:

- 2020 *Florida Building Code—Building*
- 2020 *Florida Building Code—Residential*

2.0 CONCLUSIONS

The Hilti HIT-RE 100 Adhesive Anchoring System, described in Sections 2.0 through 7.0 of ICC-ES evaluation report ESR-3829, complies with the *Florida Building Code—Building* and the *Florida Building Code—Residential*, provided the design requirements are determined in accordance with the *Florida Building Code—Building* or the *Florida Building Code—Residential*, as applicable. The installation requirements noted in ICC-ES evaluation report ESR-3829 for the 2018 *International Building Code*® meet the requirements of the *Florida Building Code—Building* or the *Florida Building Code—Residential*, as applicable.

Use of the Hilti HIT-RE 100 Adhesive Anchoring System has also been found to be in compliance with the High-Velocity Hurricane Zone provisions of the *Florida Building Code—Building* and the *Florida Building Code—Residential* with the following condition.

- a) For anchorage of wood members, the connection subject to uplift, must be designed for no less than 700 pounds (3114 N).

For products falling under Florida Rule 61G20-3, verification that the report holder's quality-assurance program is audited by a quality-assurance entity approved by the Florida Building Commission for the type of inspections being conducted is the responsibility of an approved validation entity (or the code official, when the report holder does not possess an approval by the Commission).

This supplement expires concurrently with the evaluation report, reissued April 2022 and revised February 2023.