

HILTI



Hilti HIT-RE 500 V3 1400 Jumbo

Instructions for use [en](#)

Instrucciones de uso [es](#)

Mode d'emploi [fr](#)

Instruções de utilização [pt](#)

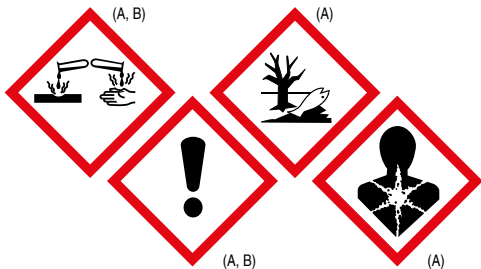

Danger







Contains: Bisphenol-A-Epichlorhydrin Epoxy resin Average MW < 700 (A); Trimethylolpropane triglycidylether (A); 2-methyl-1,5-pentanediamine (B); m-Xylylenediamine (B);











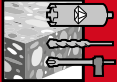





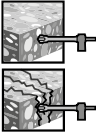
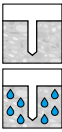
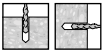



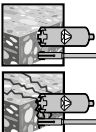





Causes severe skin burns and eye damage (A, B)
May cause an allergic skin reaction (A, B)
May cause respiratory irritation (B)
May damage fertility (A)
Toxic to aquatic life with long lasting effects (A)

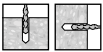

ICC-ES ESR - 3814

<p>en</p>	<p>Adhesive anchoring system for rebar and anchor fastenings in concrete. Read the safety instructions, general informations and warnings before using the product.</p>	<p>→  42 43</p>
<p>es</p>	<p>Resina de inyección para la fijación de anclajes y tacos en hormigón. Lea las indicaciones de seguridad, la información general y las advertencias antes de utilizar el producto.</p>	<p>→  44 45</p>
<p>fr</p>	<p>Mortier de scellement pour ancrage de chevilles et d'armatures dans le béton. Avant utilisation, bien lire les prescriptions de sécurité, les informations générales et les indications d'avertissement.</p>	<p>→  46 47</p>
<p>pt</p>	<p>Buchas químicas para fixações de ferros e de ancoragens em betão. Antes da aplicação, ler a ficha de segurança, as informações gerais e as advertências.</p>	<p>→  48 49</p>

1			9/16" ... 1 3/4" 14...40 mm	2 3/4" ...10" 70...250 mm		
2			9/16" ... 1 3/4" 14...40 mm	2 3/4" ...75" 70...1920 mm		
3						
4			9/16" ... 1 3/4" 14...40 mm	2 3/4" ...10" 70...250 mm		
5			9/16" ... 1 3/4" 14...40 mm	2 3/4" ...75" 70...1920 mm		
6			9/16" ... 1 3/4" 14...40 mm	2 3/4" ...25" 70...635 mm		
7			9/16" ... 1 1/8" 14...32 mm	2 3/4" ...10" 70...250 mm		

						
8			$\frac{9}{16}'' \dots 1 \frac{1}{8}''$ 14...32 mm	$2 \frac{3}{4}'' \dots 39 \frac{3}{8}''$ 70...1000 mm		
9						
10			$\frac{3}{4}'' \dots 1 \frac{3}{8}''$ 18...35 mm	$3 \frac{1}{2}'' \dots 10''$ 80...250 mm		
11						
12						
13			$\frac{9}{16}'' \dots 1 \frac{3}{4}''$ 14...40 mm	$4 \frac{1}{2}'' \dots 10''$ 110...250 mm		
14						
15						



en	Dry concrete	Water saturated concrete	Waterfilled borehole in concrete	Submerged borehole in concrete
es	Hormigón seco	Hormigón saturado de agua	Taladro lleno de agua en hormigón	Taladro sumergido en hormigón
fr	Béton sec	Béton saturé d'eau	Trou dans le béton rempli d'eau	Trou dans le béton immergé
pt	Betão seco	Betão saturado de água	Furo em betão cheio de água	Furo debaixo de água em betão



en	Threaded rod Threaded sleeve	Rebar	Uncracked concrete	Cracked concrete
es	Tige fileté Douille fileté	Armature métallique	Béton non lézardé	Béton lézardé
fr	Varilla roscada Manguito roscado	Barras corrugadas para armado	Hormigón no fisurado	Hormigón fisurado
pt	Barra roscada Casquilho roscado	Ferros de armadura	Betão não fissurado	Betão fissurado



en	Hammer drilling	Diamond coring	Hollow drill bit	Roughening tool
es	Taladrado con martillo	Taladrado con diamante	Taladro con broca hueca y aspiración	Útil de rugosidad
fr	Perçage avec percussion	Forage au diamant	Foret creux	Outil de rugosification
pt	Perfurar de martelo	Perfurar com equipamento diamantado	Broca de coroa oca	Ferramenta de rugosidade

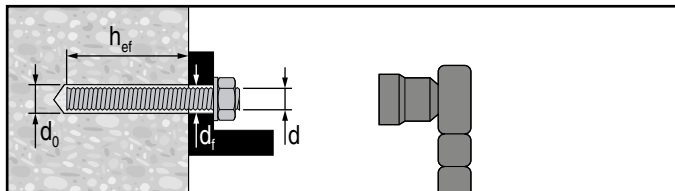

en	Working time	Initial curing time	Curing time	Roughening time
es	Tiempo de tratamiento	Resistencia de montaje	Tiempo de fraguado	Tiempo de rugosidad
fr	Temps de manipulation	Stabilité du montage	Temps de durcissement	Temps de rugosification
pt	Tempo de trabalho	Resistência de montagem	Tempo de cura total	Tempo de rugosidade

HIT-V (-R, -F, -HCR) / HAS-E (-B7) / HAS-R

HAS / HIT-V

 Ø d [inch]	Ø d ₀ [inch]	h _{ef} [inch]	Ø d _f [inch]	T _{max} [ft-lb]	T _{max} [Nm]
1/2	9/16	2 3/4 ... 10	9/16	30	41
5/8	3/4	3 1/8 ... 12 1/2	11/16	60	81
3/4	7/8	3 1/2 ... 15	13/16	100	136
7/8	1	3 1/2 ... 17 1/2	15/16	125	169
1	1 1/8	4 ... 20	1 1/8	150	203
1 1/4	1 3/8	5 ... 25	1 3/8	200	271

HIT-V

 Ø d [mm]	Ø d ₀ [mm]	h _{ef} [mm]	Ø d _f [mm]	T _{max} [Nm]
M12	14	70...240	14	40
M16	18	80...320	18	80
M20	22	90...400	22	150
M24	28	100...480	26	200
M27	30	110...540	30	270
M30	35	120...600	33	300

1 inch = 25,4 mm

HIS (-N, -RN)

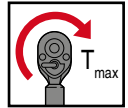
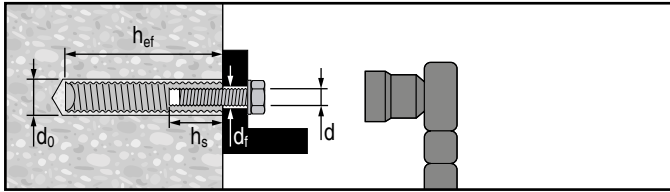

 $\varnothing d$ [inch]	$\varnothing d_0$ [inch]	h_{ef} [inch]	$\varnothing d_f$ [inch]	h_s [inch]	T_{max} [ft-lb]	T_{max} [Nm]
$\frac{3}{8}$	$1\frac{1}{16}$	$4\frac{3}{8}$	$\frac{7}{16}$	$\frac{3}{8} \dots \frac{15}{16}$	15	20
$\frac{1}{2}$	$\frac{7}{8}$	5	$\frac{9}{16}$	$\frac{1}{2} \dots 1\frac{3}{16}$	30	41
$\frac{5}{8}$	$1\frac{1}{8}$	$6\frac{3}{4}$	$\frac{11}{16}$	$\frac{5}{8} \dots 1\frac{1}{2}$	60	81
$\frac{3}{4}$	$1\frac{1}{4}$	$8\frac{1}{8}$	$\frac{13}{16}$	$\frac{3}{4} \dots 1\frac{7}{8}$	100	136

 $\varnothing d$ [mm]	$\varnothing d_0$ [mm]	h_{ef} [mm]	$\varnothing d_f$ [mm]	h_s [mm]	T_{max} [Nm]
M8	14	90	9	8...20	10
M10	18	110	12	10...25	20
M12	22	125	14	12...30	40
M16	28	170	18	16...40	80
M20	32	205	22	20...50	150

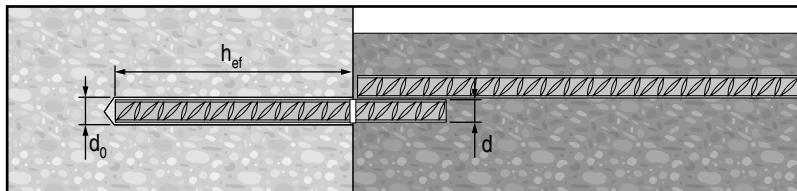
Rebar

US Rebar

	$\varnothing d_0$ [inch]	h_{ef} [inch]
d		
#3	$\frac{1}{2}$	$2\frac{3}{8} \dots 22\frac{1}{2}$
#4	$\frac{5}{8}$	$2\frac{3}{4} \dots 30$
#5	$\frac{3}{4}$	$3\frac{1}{8} \dots 37\frac{1}{2}$
#6	$\frac{7}{8}$	$3\frac{1}{2} \dots 15$
	1	$15 \dots 45$
#7	1	$3\frac{1}{2} \dots 17\frac{1}{2}$
	$1\frac{1}{8}$	$17\frac{1}{2} \dots 52\frac{1}{2}$
#8	$1\frac{1}{8}$	$4 \dots 20$
	$1\frac{1}{4}$	$20 \dots 60$
#9	$1\frac{3}{8}$	$4\frac{1}{2} \dots 67\frac{1}{2}$
#10	$1\frac{1}{2}$	$5 \dots 75$
#11	$1\frac{3}{4}$	$5\frac{1}{2} \dots 82\frac{1}{2}$

CA Rebar

	$\varnothing d_0$ [inch]	h_{ef} [mm]
d		
10 M	$\frac{9}{16}$	$70 \dots 678$
15 M	$\frac{3}{4}$	$80 \dots 960$
20 M	1	$90 \dots 1170$
25 M	$1\frac{1}{4}$ (32 mm)	$101 \dots 1512$
30 M	$1\frac{1}{2}$	$120 \dots 1794$

1 inch = 25,4 mm

Rebar

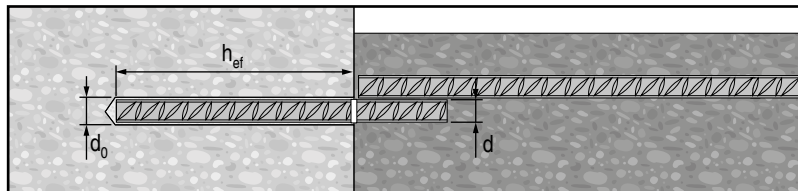

EU Rebar

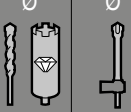

 $\varnothing d$ [mm]	$\varnothing d_0$ [mm]	h_{ef} [mm]
12	16	70...720
14	18	75...840
16	20	80...960
18	22	85...1080
20	25	90...1200
22	28	95...1320
24	32	96...1440
25	32	100...1500
26	35	104...1560
28	35	112...1680
30	37	120...1800
32	40	128...1920



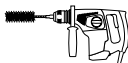

		HAS	HIS-N	Rebar	HIT-RB	HIT-SZ	HIT-DL	TE-YRT
d ₀ [inch]		d [inch]			[inch]	[inch]	[inch]	[inch]
9/16	9/16	1/2	–	10M	9/16	9/16	9/16	
5/8	5/8	–	–	#4	5/8	5/8	9/16	
11/16	11/16	–	3/8	–	11/16	11/16	11/16	
3/4	3/4	5/8	–	15M #5	3/4	3/4	3/4	3/4
7/8	7/8	3/4	1/2	#6	7/8	7/8	7/8	7/8
1	1	7/8	–	20M #6 #7	1	1	1	1
1 1/8	1 1/8	1	5/8	#7 #8	1 1/8	1 1/8	1	1 1/8
1 1/4	–	–	3/4	25M #8	1 1/4	1 1/4	1	
1 3/8	–	1 1/4	–	#9	1 3/8	1 3/8	1 3/8	1 3/8
1 1/2	–	–	–	30M #10	1 1/2	1 1/2	1 3/8	
1 3/4	–	–	–	#11	1 3/4	1 3/4	1 3/8	







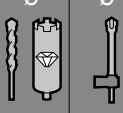

HIT-DL: h_{ef} > 10"

HIT-RB: h_{ef} > 20 x d

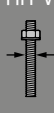

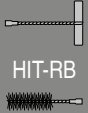
Hiti VC 150/300		HIT-OHC		HIT-OHW
		HIT-...	Art. No.	Art. No.
min. 61 l/s	Ø d ₀ [inch]	OHC 1	387551	387550
	7/8 ... 1 3/4	OHC 2	387552	





			
d ₀ [inch]	[inch]	Art. No. 381215	
9/16" ... 1 1/8"	2 3/8" ... 52 1/2"	✓	≥ 6 bar/90 psi @ 6 m³/h
1 1/4" ... 1 1/2"	4" ... 75"	–	≥ 140 m³/h / ≥ 82 CFM



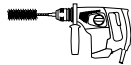

\emptyset	\emptyset	HIT-V	HIS-N	Rebar	HIT-RB	HIT-SZ	HIT-DL	TE-YRT
								
d_0 [mm]		d [mm]			[mm]	[mm]		[mm]
14	14	12	8	10	14	14	14	
16	16	-	-	12	16	16	16	
18	18	16	10	14	18	18	18	18
20	20	-	-	16	20	20	20	20
22	22	20	12	18	22	22	20	22
25	25	-	-	20	25	25	25	25
28	28	24	16	22	28	28	25	28
30	30	27	-	-	30	30	25	30
32	32	-	20	24/25	32	32	32	32
35	-	30	-	26/28	35	35	32	35
37	-	-	-	30	37	37	32	
40	-	-	-	32	40	40	32	







HIT-DL: $h_{ef} > 250$ mm

HIT-RB: $h_{ef} > 20 \times d$





Hilti VC 150/300		HIT-OHC		HIT-OHW
				
	$\emptyset d_0$ [mm]	HIT-...	Art. No.	Art. No.
min. 61 l/s	14 ... 20	OHC 1	387551	387550
	22 ... 32	OHC 2	387552	

			
d_0 [mm]	[mm]	Art. No. 381215	
14...32	70...1500	✓	≥ 6 bar/90 psi
35...40	100...1920	-	≥ 140 m ³ /h

				
[°F]	[°C]	 t_{work}	 $t_{cure, ini}$	 $t_{cure, full}$
23	-5	2 h	48 h	168 h
32	0	2 h	24 h	36 h
40	4	2 h	16 h	24 h
50	10	1.5 h	12 h	16 h
60	16	1 h	8 h	16 h
72	22	25 min	4 h	6.5 h
85	29	15 min	2.5 h	5 h
95	35	12 min	2 h	4.5 h
105	41	10 min	2 h	4 h

 $\geq +5\text{ }^{\circ}\text{C} / 41\text{ }^{\circ}\text{F}$

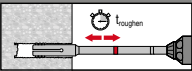
 = 2x t_{cure}

		
h_{ef} [inch]	h_{ef} [mm]	 $t_{toughen}$
0 ... 4	0 ... 100	10 sec
4.01 ... 8	101 ... 200	20 sec
8.01 ... 12	201 ... 300	30 sec
12.01 ... 16	301 ... 400	40 sec
16.01 ... 20	401 ... 500	50 sec
20.01 ... 25	501 ... 600	60 sec





$$t_{toughen} = h_{ef} [\text{inch}] * 2.5$$

$$t_{toughen} = h_{ef} [\text{mm}] / 10$$

 Rebar - $h_{ef} \geq 20d$

		h_{ef}		
HDM, HDE, HIT-P 8000D	\leq US #5	12 1/2 ... 37 1/2 [inch]	23 °F ... 104 °F -5 °C ... 40 °C	41 °F ... 104 °F 5 °C ... 40 °C
	\leq EU 16mm	320 ... 960 [mm]		
	\leq CAN 15M	320 ... 960 [mm]		
HDE, HIT-P 8000D	\leq US #7	17 1/2 ... 52 1/2 [inch]	23 °F ... 104 °F -5 °C ... 40 °C	41 °F ... 104 °F 5 °C ... 40 °C
	\leq EU 20mm	400 ... 1200 [mm]		
	\leq CAN 20M	390 ... 1170 [mm]		
HIT-P 8000D	\leq US #10	25 ... 75 [inch]	23 °F ... 104 °F -5 °C ... 40 °C	41 °F ... 104 °F 5 °C ... 40 °C
	\leq EU 32mm	640 ... 1920 [mm]		
	\leq CAN 30M	598 ... 1794 [mm]		



		h_{ef}		
HDM, HDE, HIT-P 8000D	\leq US #5	12 1/2 ... 37 1/2 [inch]	23 °F ... 104 °F -5 °C ... 40 °C	41 °F ... 104 °F 5 °C ... 40 °C
	\leq EU 16mm	320 ... 960 [mm]		
	\leq CAN 15M	320 ... 960 [mm]		
HDE, HIT-P 8000D	\leq US #7	17 1/2 ... 39 3/8 [inch]	23 °F ... 104 °F -5 °C ... 40 °C	41 °F ... 104 °F 5 °C ... 40 °C
	\leq EU 20mm	400 ... 1000 [mm]		
	\leq CAN 20M	390 ... 1000 [mm]		

1

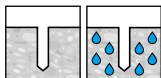
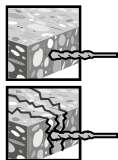

d_0 :
 $\frac{9}{16}$ "... $1\frac{3}{4}$ "
 14...40 mm

h_{ef} :
 $2\frac{3}{4}$ "...10"
 70...250 mm

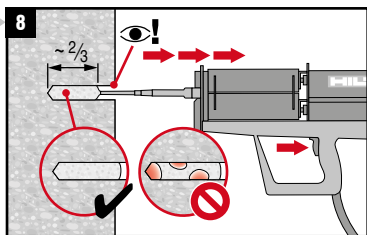
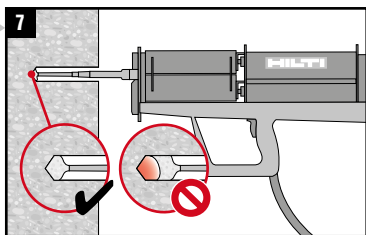
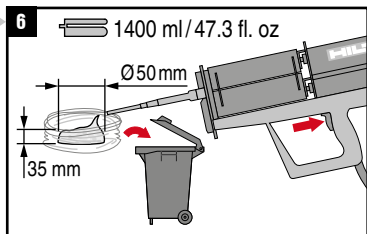
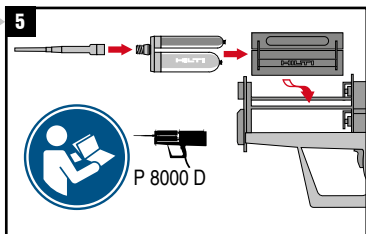
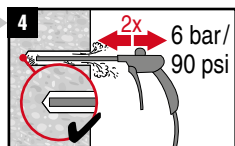
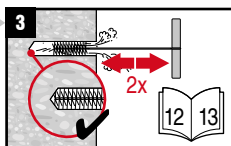
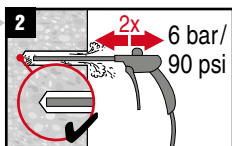
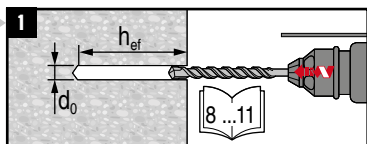
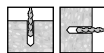

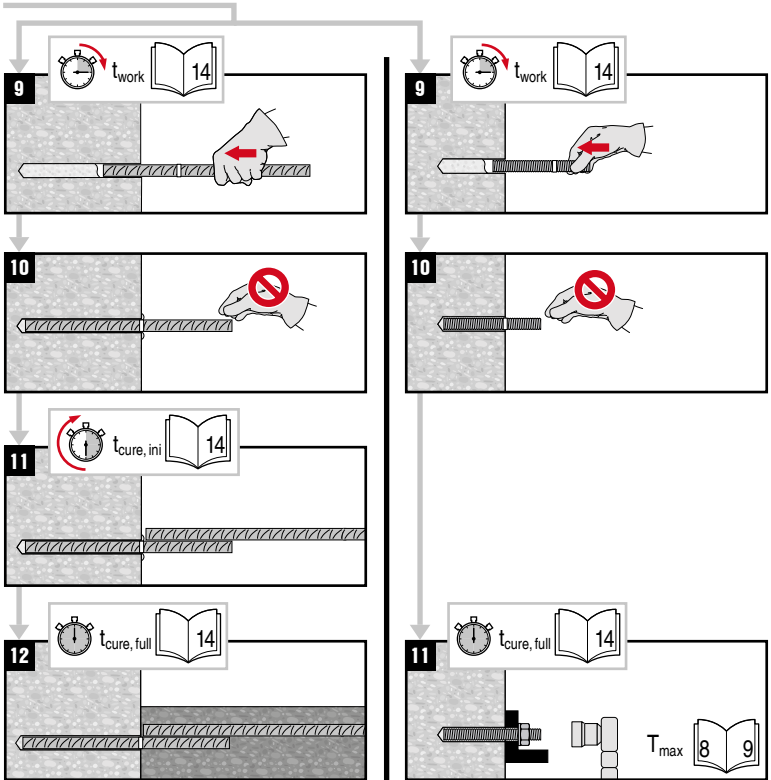

2

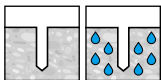
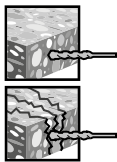

d_0 :
 $9/16'' \dots 1 \ 3/4''$
 14...40 mm

h_{ef} :
 $2 \ 3/4'' \dots 75''$
 70...1920 mm

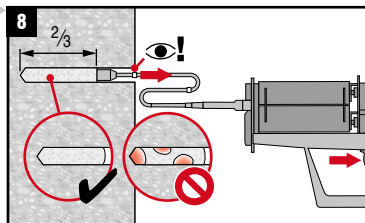
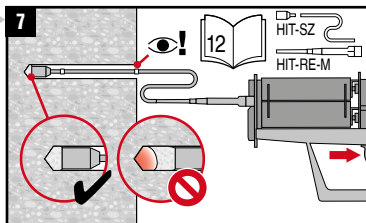
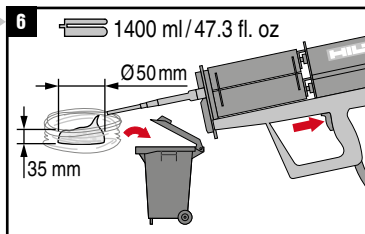
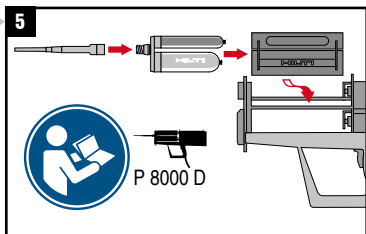
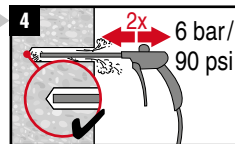
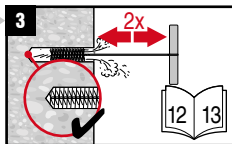
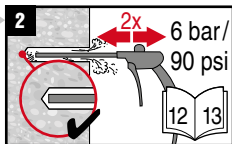
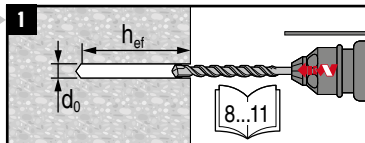
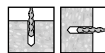

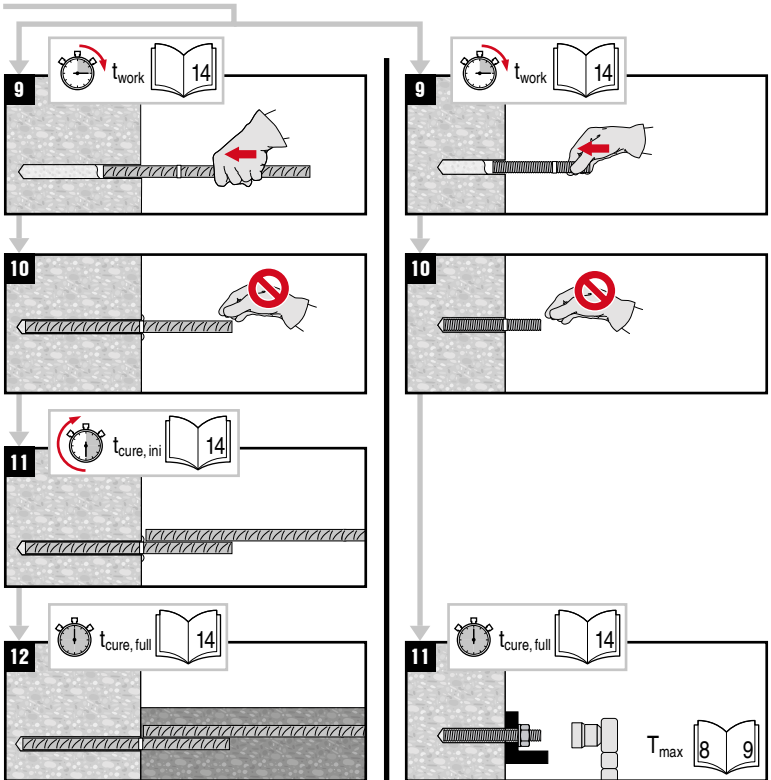

3

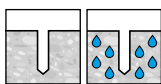
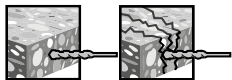

d_0 :
 $\frac{9}{16}'' \dots 1 \frac{3}{4}''$
 $14 \dots 40 \text{ mm}$

h_{ef} :
 $2 \frac{3}{4}'' \dots .75''$
 $70 \dots 1920 \text{ mm}$

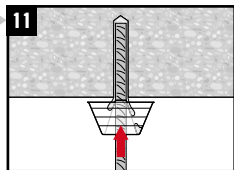
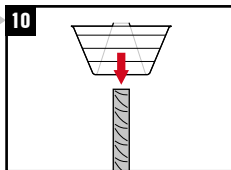
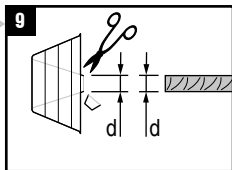
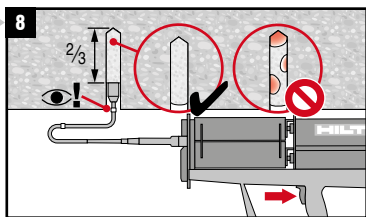
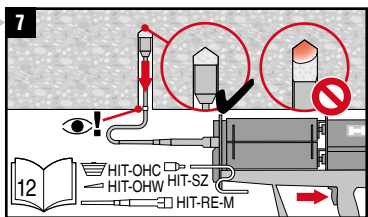
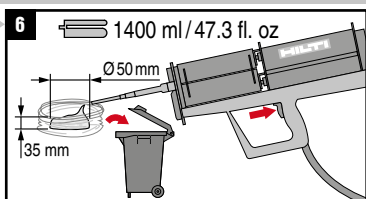
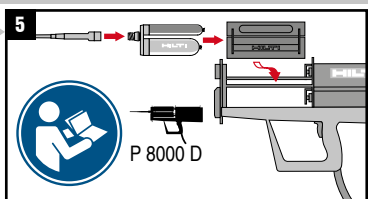
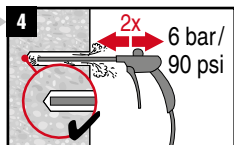
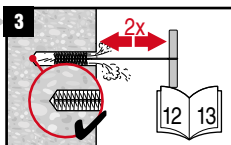
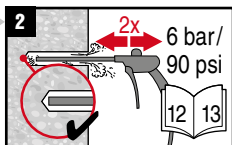
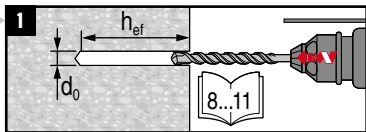

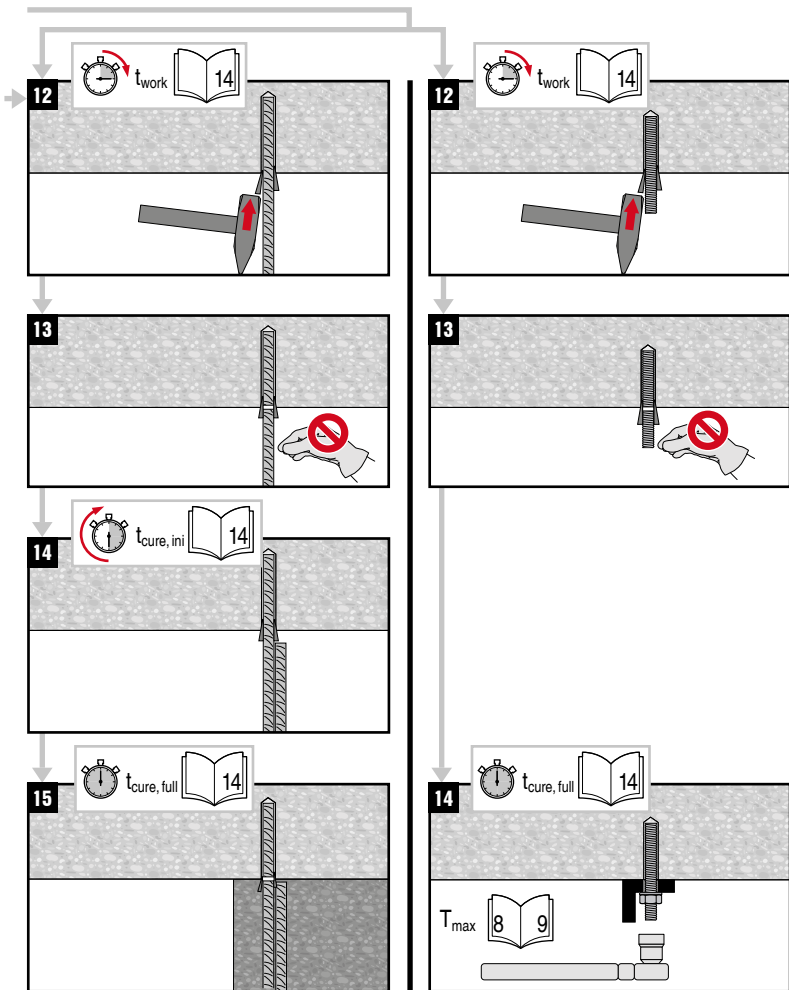

4

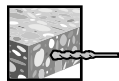

d_0 :
 $\frac{9}{16}'' \dots 1\frac{3}{4}''$
 14...40 mm

h_{ef} :
 $2\frac{3}{4}'' \dots 10''$
 70...250 mm

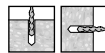

13

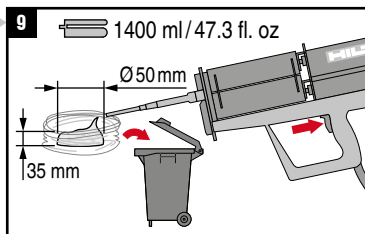
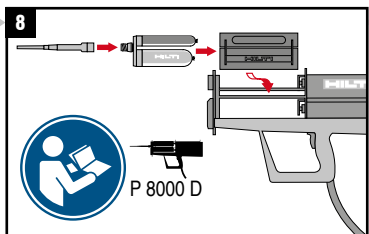
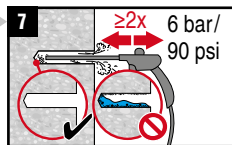
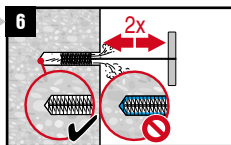
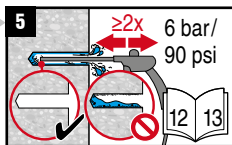
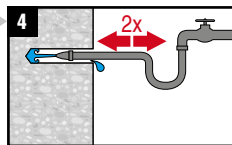
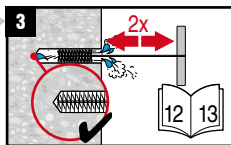
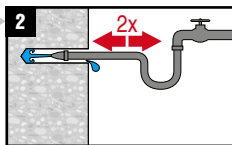
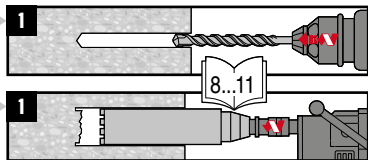
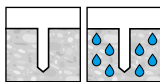
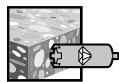

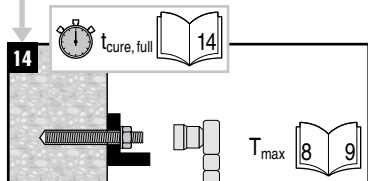
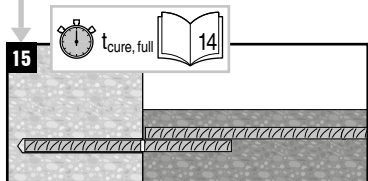
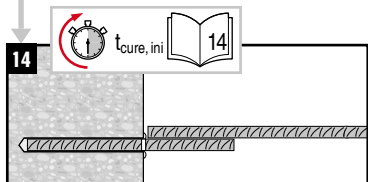
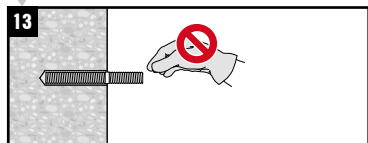
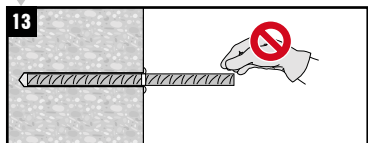
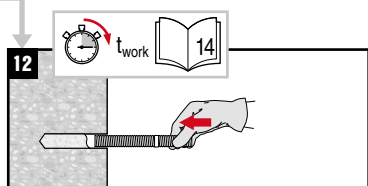
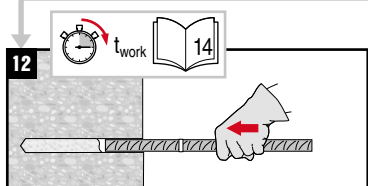
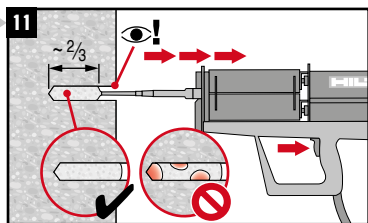
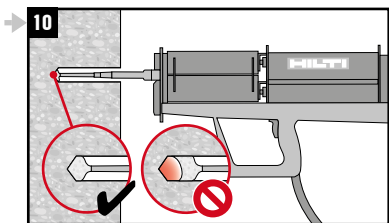

5

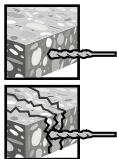

d_0 :
 $\frac{9}{16}$ "...1 $\frac{3}{4}$ "
 14...40 mm

h_{ef} :
 $2\frac{3}{4}$ "...75"
 70...1920 mm

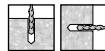

14

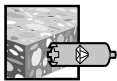

h_{ef} :
 $2\frac{3}{4}$ "...25"
 70...640 mm

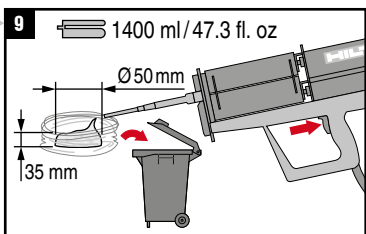
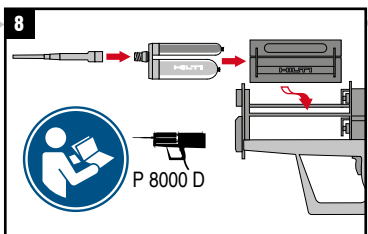
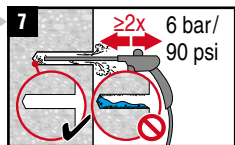
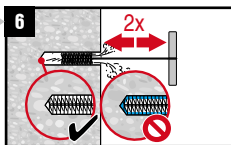
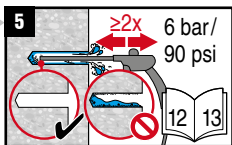
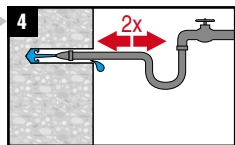
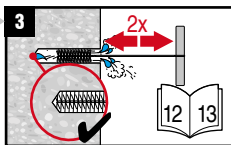
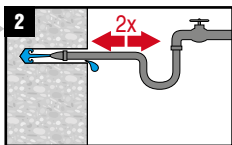
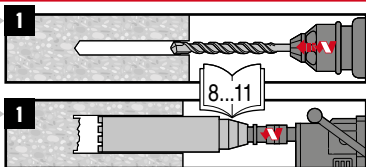

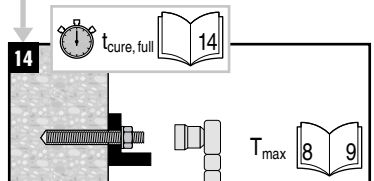
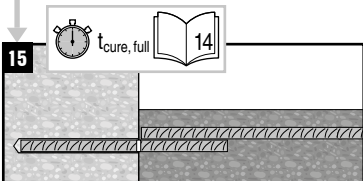
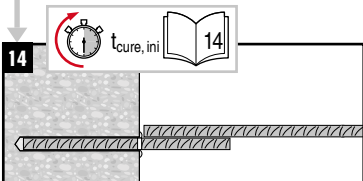
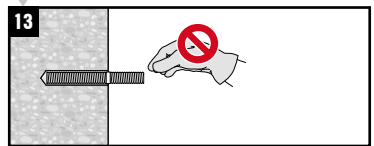
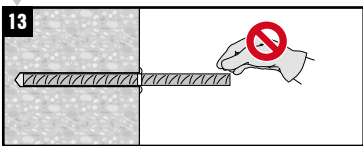
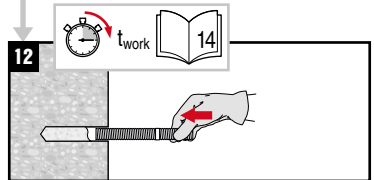
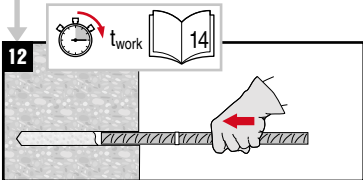
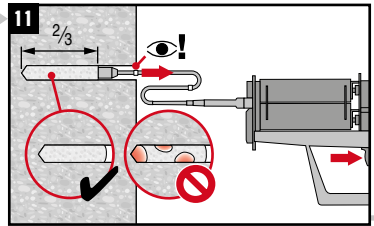
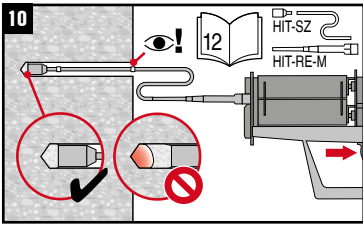

6



d_0 :
 $\frac{9}{16}$ "... $1\frac{3}{4}$ "
 14...40 mm

h_{ef} :
 $2\frac{3}{8}$ "...25"
 70...635 mm

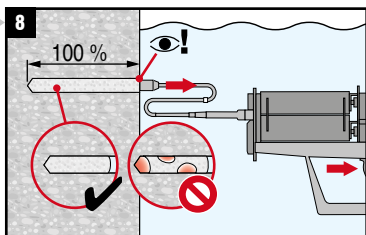
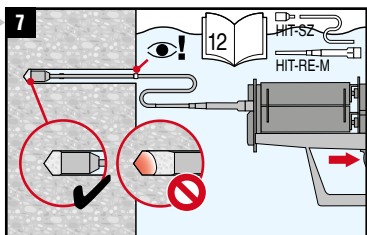
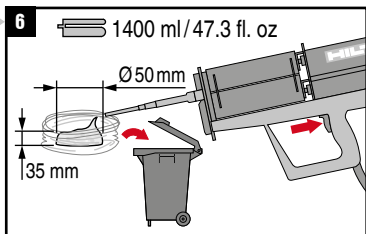
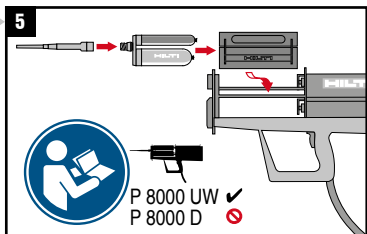
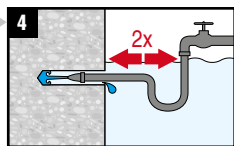
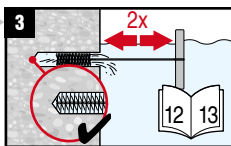
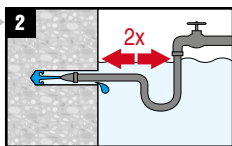
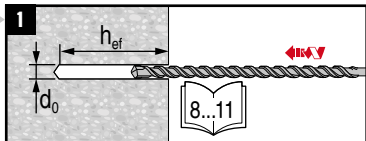
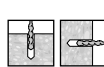

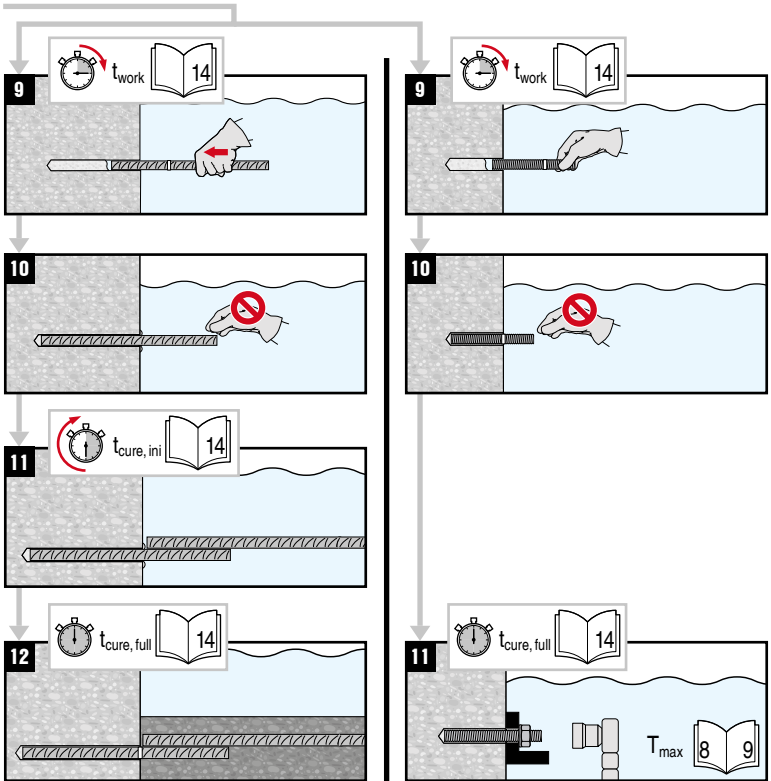

7

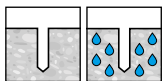
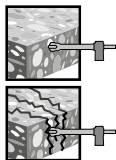

d_0 :
 $\frac{9}{16} \dots 1 \frac{1}{8}''$
 14...32 mm

h_{ef} :
 $2 \frac{3}{4}'' \dots 10''$
 70...250 mm

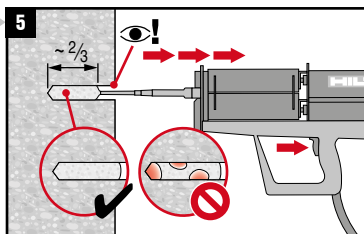
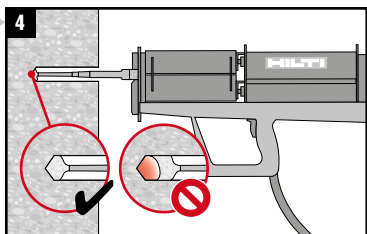
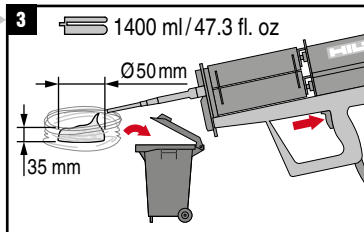
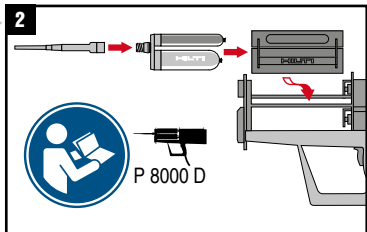
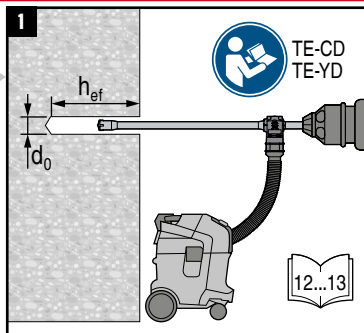
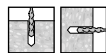

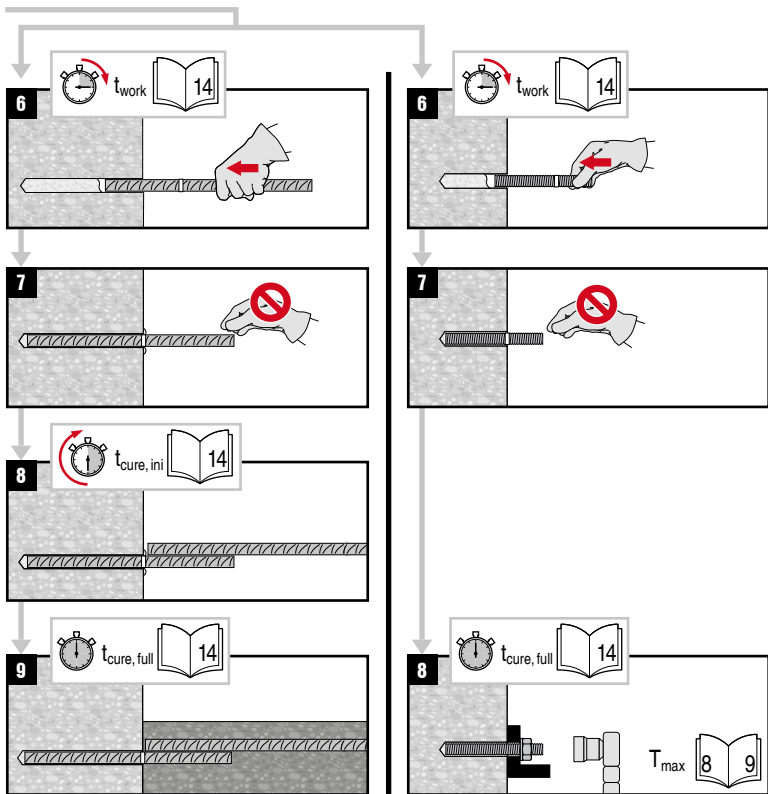

8

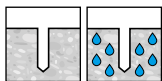
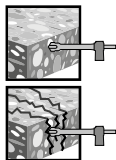

d_0 :
 $\frac{9}{16}$ " ... $1 \frac{1}{8}$ "
 14...32 mm

h_{ef} :
 $2 \frac{3}{4}$ " ... $39 \frac{3}{8}$ "
 70...1000 mm

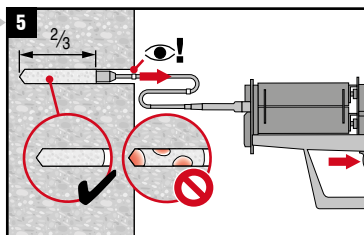
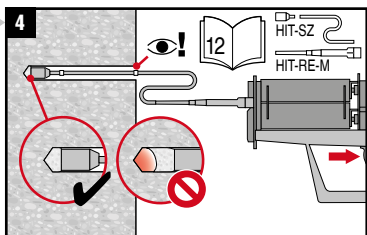
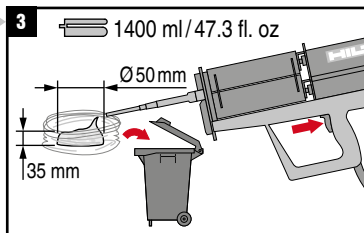
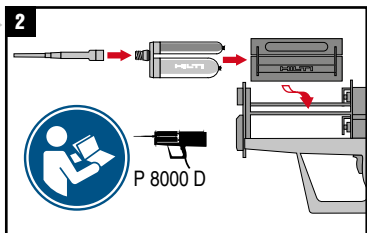
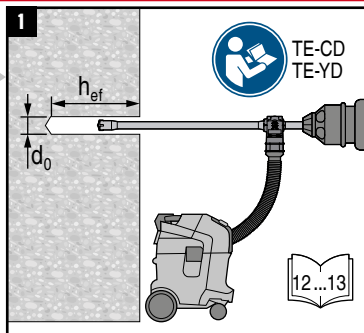
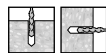

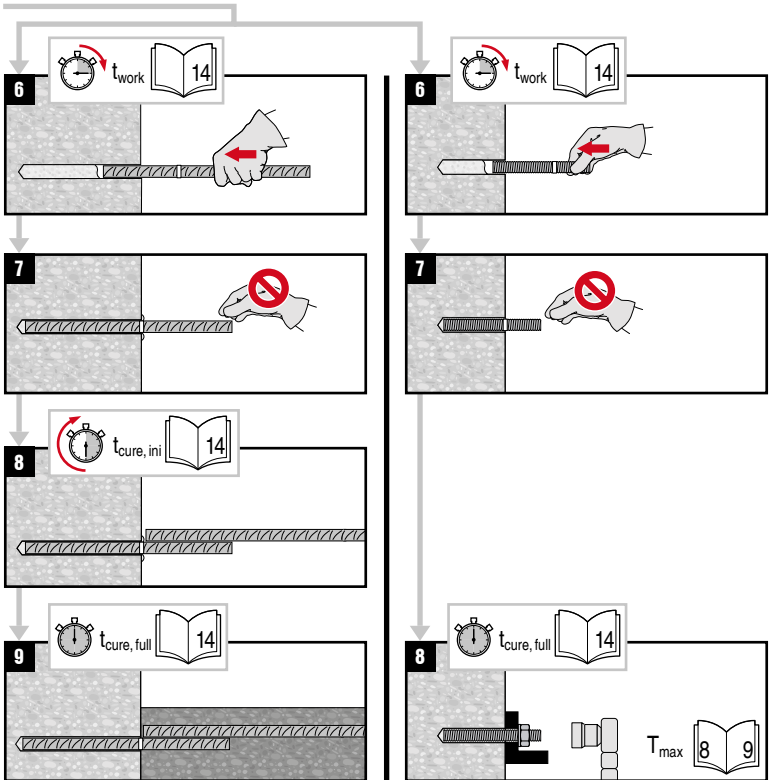

9

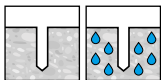
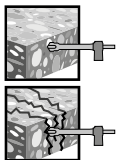
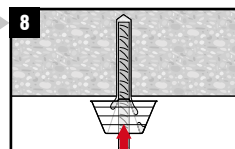
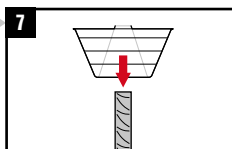
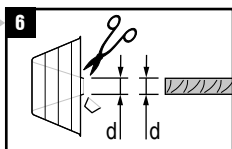
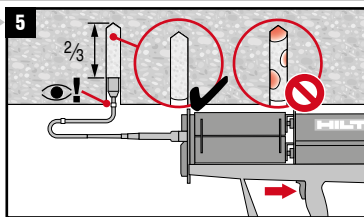
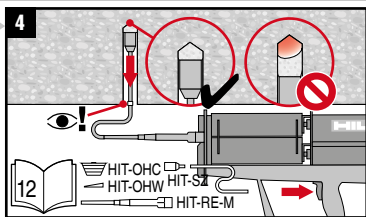
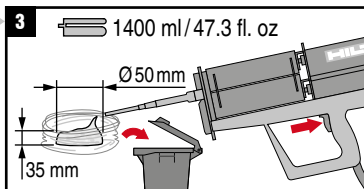
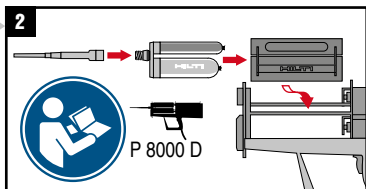
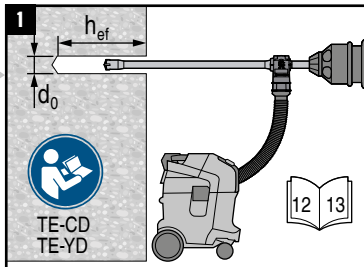
 d_0 :
 $9/16" \dots 1 1/8"$
 $14 \dots 32 \text{ mm}$
 h_{ef} :
 $2 3/4" \dots 39 3/8"$
 $70 \dots 1000 \text{ mm}$

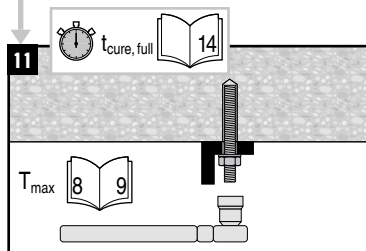
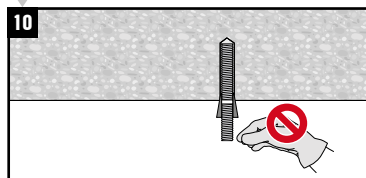
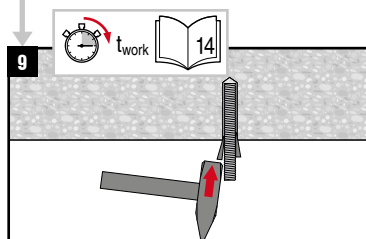
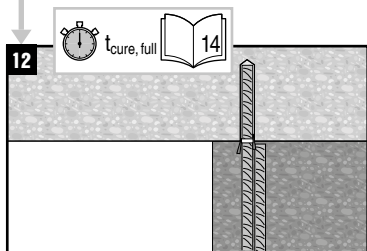
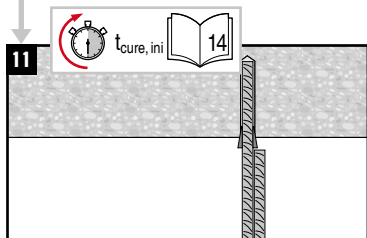
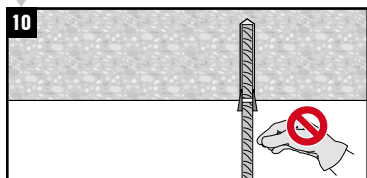
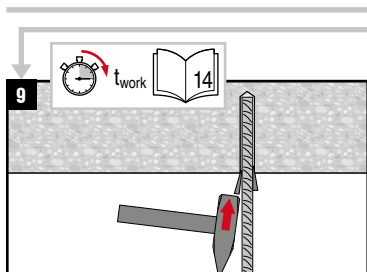

10

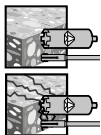

3/4" ... 1 3/8"
18 ... 35 mm

3 1/8" ... 10"
80 ... 250 mm

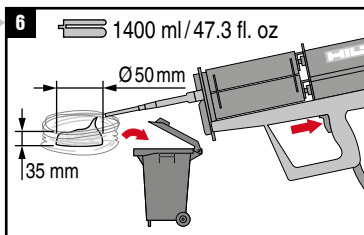
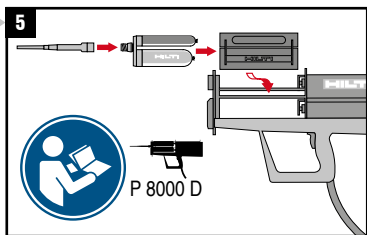
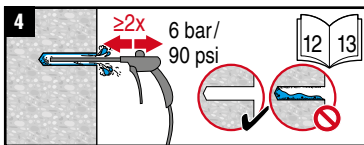
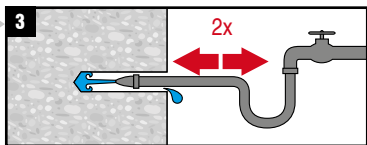
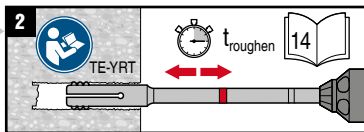
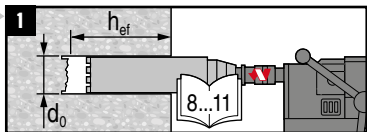
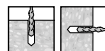

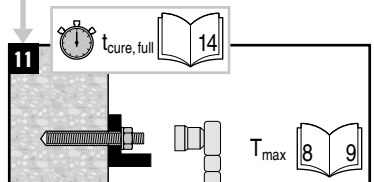
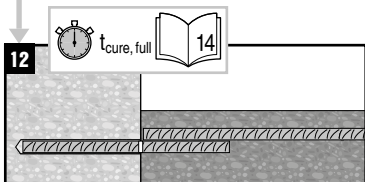
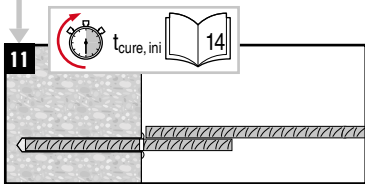
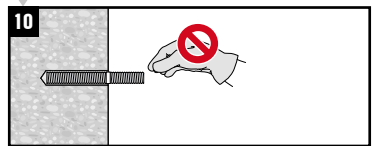
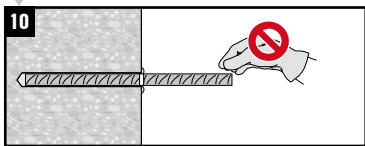
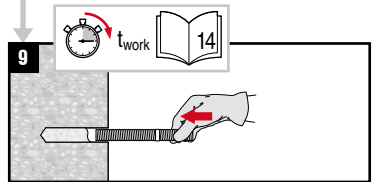
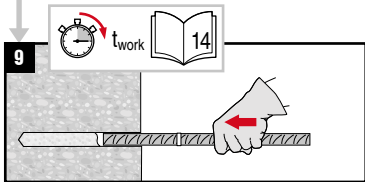
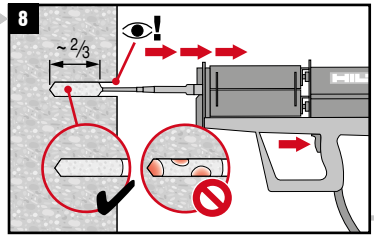
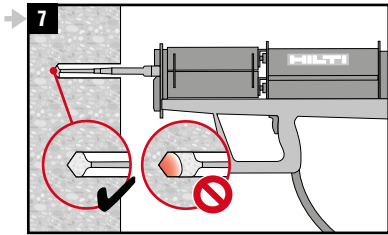

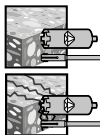

3/4" ... 1 3/8"
18 ... 35 mm

3 1/8" ... 25"
80 ... 635 mm

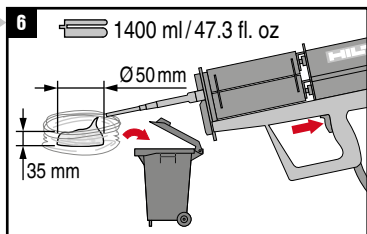
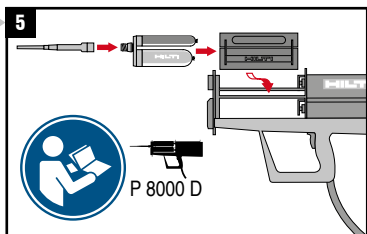
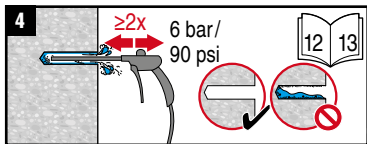
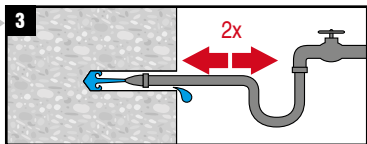
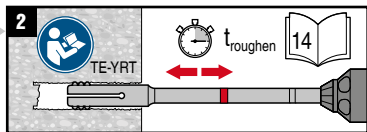
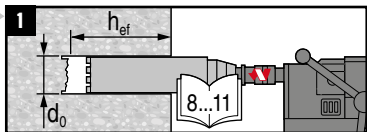
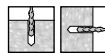

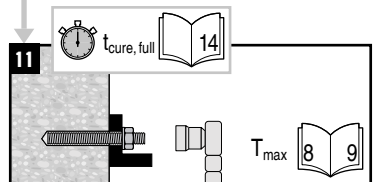
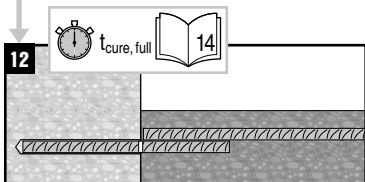
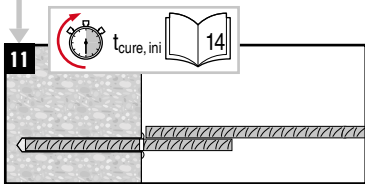
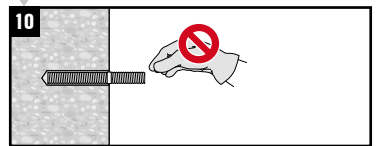
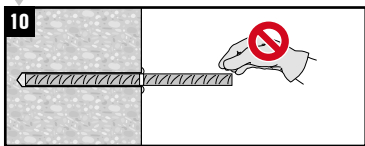
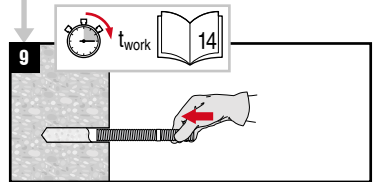
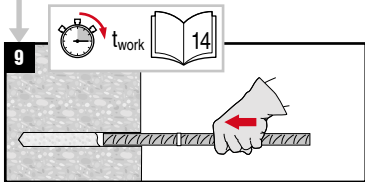
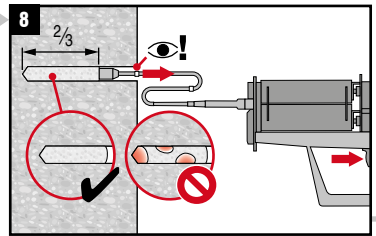
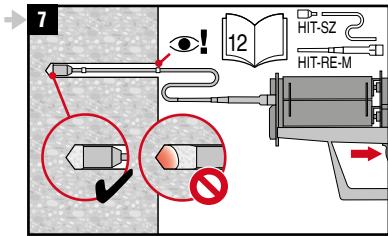

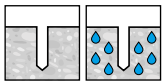
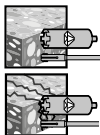

d_0 :
 $3/4'' \dots 1 \ 3/8''$
 $18 \dots 35 \text{ mm}$

h_{ef} :
 $3 \ 1/8'' \dots 25''$
 $80 \dots 635 \text{ mm}$

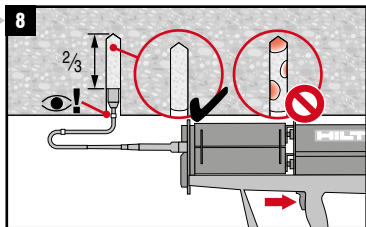
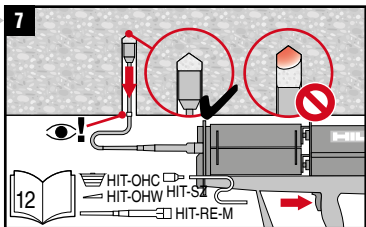
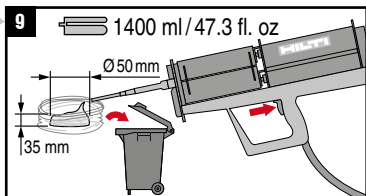
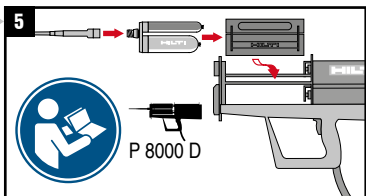
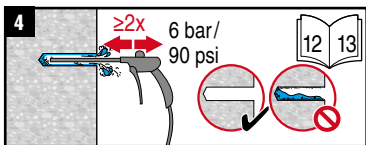
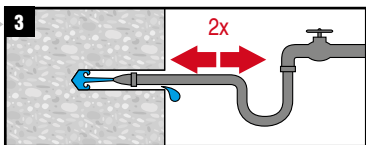
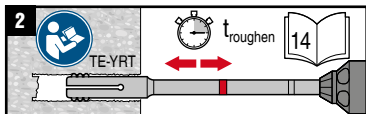
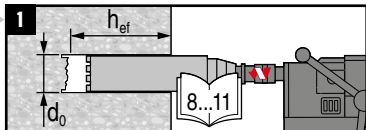

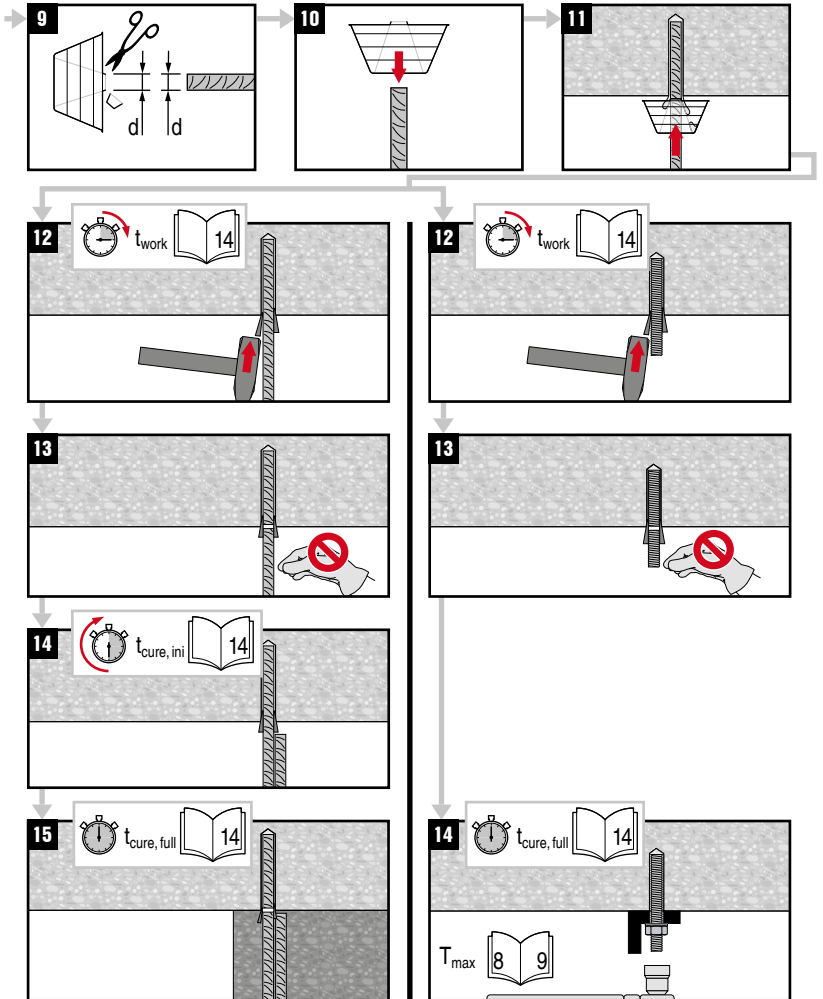

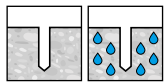
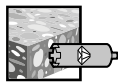

d_0 :
 $9/16'' \dots 1 \frac{3}{4}''$
 14...40 mm

h_{ef} :
 $2 \frac{3}{4}'' \dots 25''$
 70...635 mm

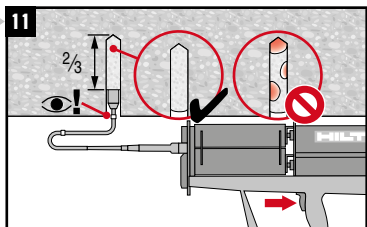
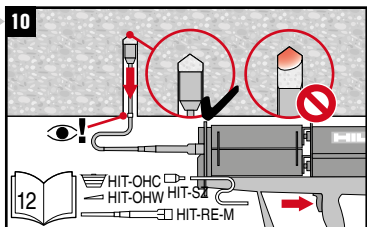
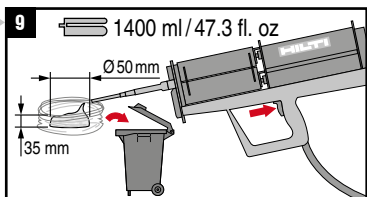
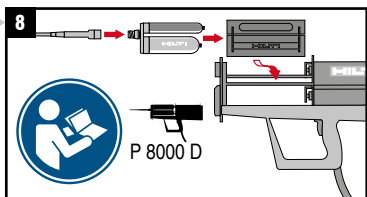
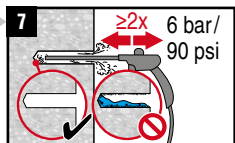
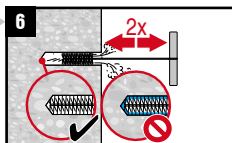
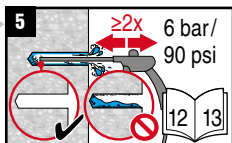
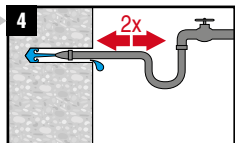
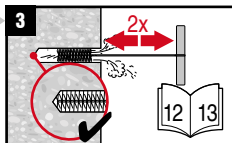
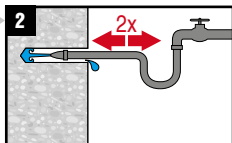
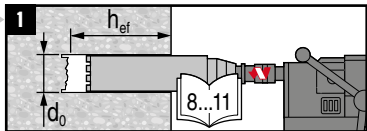

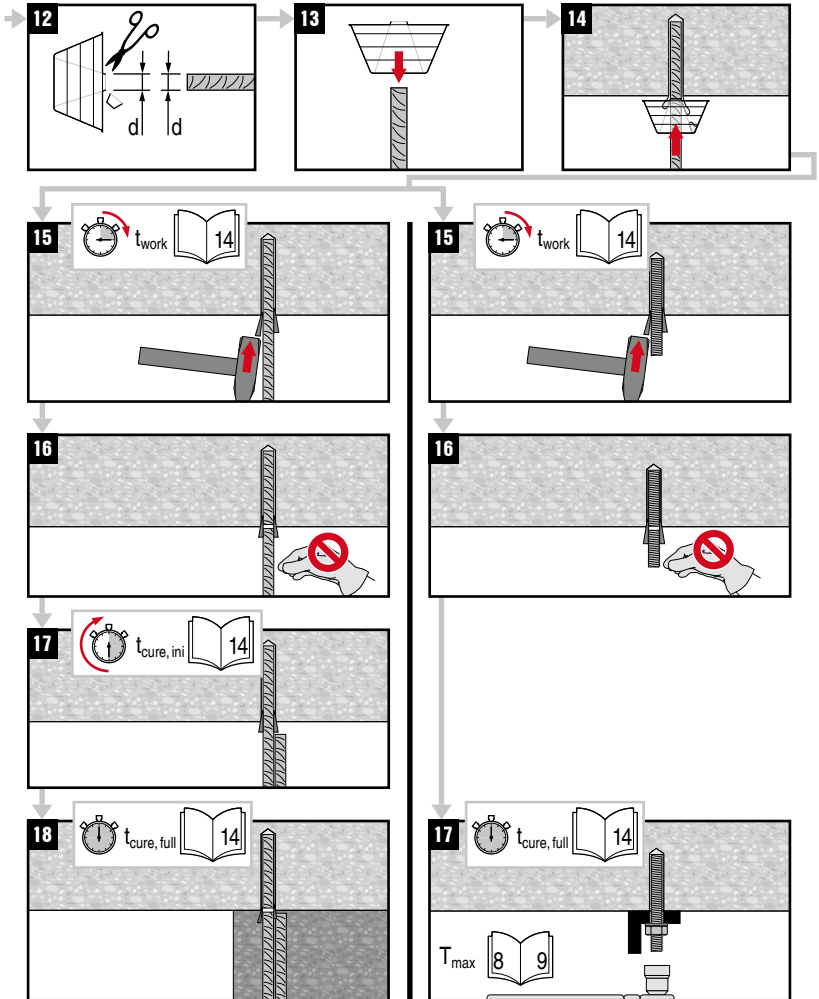

Adhesive anchoring system for rebar and anchor fastenings in concrete

- ▶ Prior to use of product, follow the instructions for use and the legally obligated safety precautions.
- ▶ See the Safety Data Sheet for this product.

Hilti HIT-RE 500 V3

Contains: Bisphenol-A-Epichlorhydrin Epoxy resin Average MW < 700 (A); Trimethylolpropane triglycidylether (A); 2-methyl-1,5-pentanediamine (B); m-Xylylenediamine (B);



Danger

H314	Causes severe skin burns and eye damage.(A,B)
H317	May cause an allergic skin reaction.(A,B)
H335	May cause respiratory irritation (A,B)
H360	May damage fertility (A)
H411	Toxic to aquatic life with long lasting effects.(A)

P280	Wear protective gloves/protective clothing/eye protection/face protection.
P260	Do not breathe vapours.

P303+P361+P353 IF ON SKIN (or hair): Remove/Take off immediately all contaminated clothing. Rinse skin with water/shower.

P305+P351+P338 IF IN EYES: Rinse cautiously with water for several minutes. Remove contact lenses, if present and easy to do. Continue rinsing.

P333+P313 If skin irritation or rash occurs: Get medical advice/attention.

P337+P313 If eye irritation persists: Get medical advice/attention.

Recommended protective equipment:

Eye protection: Tightly sealed safety glasses e.g.: #02065449 Safety glasses PP EY-CA NCH clear; #02065591 Goggles PP EY-HA R HC/AF clear;

Protective gloves: EN 374 ; Material of gloves: Nitrile rubber, NBR

Avoid direct contact with the chemical/ the product/ the preparation by organizational measures.

Final selection of appropriate protective equipment is in the responsibility of the user

Disposal considerations

Empty packs:

- ▶ Leave the Mixer attached and dispose of via the local Green Dot collecting system
 - or EAK waste material code 15 01 02 plastic packaging.



Full or partially emptied packs:

- ▶ dispose of as special waste in accordance with official regulations.
 - EAK waste material code: 20 01 27* paint, inks, adhesives and resins containing dangerous substances.
 - or waste material code: EAK 08 04 09* waste adhesives and sealants containing organic solvents or other dangerous substances.

Content: 1400 ml / 47.3 fl.oz

Weight: 1980 g / 69.8 oz

Warranty: Refer to standard Hilti terms and conditions of sale for warranty information.

Failure to observe these installation instructions, use of non-Hilti anchors, poor or questionable concrete conditions, or unique applications may affect the reliability or performance of the fastenings.

Product Information

- Always keep this instruction for use together with the product.
- Ensure that the instruction for use is with the product when it is given to other persons.
- **Safety Data Sheet:** Review the DS before use.
- **Check expiration date:** See expiration date imprint on foilpack manifold (month/year). Do not use expired product.
- **Foil pack temperature during usage:** +5 °C to 40 °C / 41 °F to 104 °F.
- **Conditions for transport and storage:** Keep in a cool, dry and dark place between +5 °C to 25 °C / 41 °F to 77 °F.
- For any application not covered by this document / beyond values specified, please contact Hilti.
- **Partly used foil packs must be used up within one week.** Leave the mixer attached on the foil pack manifold in the dispenser and do not retract the pistons! Remove the air pressure hose and store under the recommended storage conditions. If reused, attach a new mixer and discard the initial quantity of anchor adhesive.

WARNING

Improper handling may cause mortar splashes. Eye contact with mortar may cause irreversible eye damage!

- Always wear tightly sealed safety glasses, gloves and protective clothes before handling the mortar!
- Never start dispensing without a mixer properly screwed on.
- When using an extension hose: Discard of initial mortar flow must be done through supplied mixer only (not through the extension hose).
- Attach a new mixer prior to dispensing a new foil pack (snug fit).
- Caution! Never remove the mixer while the foil pack system is under pressure.
- Use only the type of mixer supplied with the adhesive. Do not modify the mixer in any way.
- Check foil packs and foil pack holder for proper functioning or damage - especially after they have been dropped.
- Dropping foil packs, also foil packs already inserted into the foil pack holder, is likely to cause damage leading to malfunction.
- Never use damaged foil packs and/or damaged or unclean foil pack holders.

Poor load values / potential failure of fastening points due to inadequate borehole cleaning. The boreholes must be dry and free of debris, dust, water, ice, oil, grease and other contaminants prior to adhesive injection.

- Hilti hollow drill bits TE-CD, TE-YD must be used in conjunction with a properly maintained Hilti vacuum cleaner with model and suction capacity (volumetric flow rate) as specified in the accessory table.
- For blowing out the borehole - blow out with oil free air until return air stream is free of noticeable dust.
- For flushing the borehole - flush with water line pressure until water runs clear.
- Important! Remove all water from the borehole and blow out with oil free compressed air until borehole is completely dried before mortar injection (not applicable to hammer drilled hole in underwater application).

Ensure that boreholes are filled from the back of the boreholes without forming air voids.

- If necessary, use the accessories / extensions to reach the back of the borehole.
- For overhead applications use the overhead accessories HIT-SZ / IP and take special care when inserting the fastening element. Excess adhesive may be forced out of the borehole. Make sure that no mortar drips onto the installer.
- If a new mixer is installed onto a previously-opened foil pack, the first trigger pulls must be discarded.

Not adhering to these setting instructions can result in failure of fastening points.

Resina de inyección para la fijación de anclajes y tacos en hormigón

- ▶ Lea estas instrucciones de uso y observe las indicaciones de seguridad antes de utilizar el producto.
- ▶ Consulte con las Hojas de datos de seguridad para este producto.

Hilti HIT-RE 500 V3

Contiene: producto de reacción: bisfenol-A-epiclorhidrina resinas epoxi MW ≤ 700 (A); Trimethylolpropane triglycidylether (A); 2-metilpentano-1,5-diamina (B); 1,3-Bencenodimetanamina (B);



(A,B)



(A,B)



(A)



(A)



Peligro

- H314 Provoca quemaduras graves en la piel y lesiones oculares graves.(A,B)
H317 Puede provocar una reacción alérgica en la piel.(A,B)
H335 Peut irriter les voies respiratoires (A,B)
H360 Puede perjudicar la fertilidad (A)
H411 Tóxico para los organismos acuáticos, con efectos nocivos duraderos.(A)

- P280 Llevar guantes/prendas/gafas/máscara de protección.
P260 No respirar el los vapores.

P303+P361+P353 EN CASO DE CONTACTO CON LA PIEL (o el pelo): Quitarse inmediatamente las prendas contaminadas. Aclararse la piel con agua o ducharse.

P305+P351+P338 EN CASO DE CONTACTO CON LOS OJOS: Aclarar cuidadosamente con agua durante varios minutos. Quitar las lentes de contacto, si lleva y resulta fácil. Seguir aclarando.

P333+P313 En caso de irritación o erupción cutánea: Consultar a un médico.

P337+P313 Si persiste la irritación ocular: Consultar a un médico.

Equipo de protección recomendado:

Protección de ojos: gafas de protección herméticas p. ej. gafas de seguridad PP EY-CA NCH claras, código #02065449; gafas protectoras PP EY-HA R HC/AF claras, código #02065591.

Protección de manos: EN 374; material de los guantes: caucho nitrílico (NBR). Tome las medidas oportunas para evitar el contacto directo con la sustancia química/el producto/el preparado.

El usuario es el responsable final de la elección de un equipo de protección apropiado.

Indicaciones de reciclaje

Cartuchos vacíos:

- ▶ Deseche el mezclador enroscado a través los sistemas de recogida nacionales identificados con el Punto Verde
 - o el código de residuo LER: 15 01 02 embalajes de plastic.



Cartuchos llenos o parcialmente vacíos:

- ▶ Deberán eliminarse como residuos especiales de acuerdo con las normativas oficiales.
 - Código de residuo LER: 20 01 27* Pinturas, tintas, adhesivos y resinas que contienen sustancias peligrosas.
 - o el código de residuo LER: 08 04 09* Residuos de adhesivos y sellantes que contienen disolventes orgánicos u otras sustancias peligrosas.

Contenido: 1400 ml / 47.3 fl.oz

Peso: 1980 g / 69.8 oz

Garantía Para información sobre la garantía, consultar las condiciones de venta estándar de Hilti.

La inobservancia de las instrucciones de instalación, el uso de anclajes que no sean Hilti, malas o dudosas condiciones del hormigón y/o aplicaciones inadecuadas pueden afectar la fiabilidad y respuesta de las fijaciones.

ES

Información de producto

- Guarde siempre estas instrucciones de uso junto con el producto.
- En caso de entregar el producto a terceros, deben incluirse siempre las instrucciones de uso.
- **Hoja de datos de seguridad:** consulte la hoja de datos de seguridad antes de utilizar el producto.
- **Fecha de caducidad:** compruebe la fecha de caducidad (mes/año) de la pieza de conexión del cartucho. El producto no debe utilizarse después de la fecha de caducidad.
- **Temperatura del cartucho durante la utilización:** de +5 °C a 40 °C / de 41 °F a 104 °F.
- **Condiciones de transporte y almacenamiento:** lugar fresco, seco y oscuro con una temperatura de +5 °C a 25 °C / de 41 °F a 77 °F.
- Para aplicaciones que no se describen en las presentes instrucciones de uso o no se enmarcan en la especificación, póngase en contacto con Hilti.
- **Los cartuchos no agotados por completo deberán utilizarse antes de una semana.** En este caso, deje el cartucho con el mezclador enroscado en el aplicador neumático sin extraer el émbolo de presión. Desacople la herramienta del suministro de presión y guárdela conforme a las instrucciones. Antes de utilizarlo de nuevo, enroscar un nuevo mezclador y desechar la resina inicial.

ADVERTENCIA

- ▲ **La resina puede salpicar si se utiliza incorrectamente. El contacto de la resina con los ojos puede causar daños oculares permanentes.**
 - Lleve gafas protectoras herméticas, guantes de protección y ropa de trabajo durante el trabajo.
 - No comience a exprimir si no se ha enroscado el mezclador.
 - Cuando utilice la manguera de extensión: El descarte inicial de la resina se debe hacer a través del mezclador suministrado (y no a través de la manguera de extensión).
 - Enrosque un mezclador nuevo antes de exprimir un cartucho nuevo. Asegúrese de que el asiento sea firme.
 - ¡Precaución! No desatorille nunca el mezclador cuando el sistema se encuentre bajo presión. Utilice exclusivamente el modelo de mezclador suministrado con la resina. No modifique el mezclador en ningún caso.
 - Compruebe si el cartucho y el portacartuchos están en perfecto estado, en particular después de una caída. Si un cartucho se cae, aun cuando se encuentre dentro del portacartuchos, es posible que no funcione correctamente.
 - No utilice cartuchos en mal estado ni portacartuchos dañados o sucios.
- ▲ **Valores de sujeción deficientes/fallo de la fijación debido a limpieza insuficiente del taladro. Antes de inyectar la resina, los taladros deben estar secos y libres de restos de perforación, polvo, agua, hielo, aceite, grasa o cualquier otro agente contaminante.**
 - Las brocas huecas TE-CD, TE-YD de Hilti deben utilizarse con una aspiradora de Hilti en buen estado de funcionamiento del modelo y la capacidad de succión (tasa de flujo volumétrico) que se especifican en la tabla de accesorios.
 - Soplando a presión del taladro: limpie el taladro con aire a presión sin aceite hasta que el aire de retorno esté libre de polvo.
 - Lavado del taladro: lave con una manguera de agua con la presión normal de la red hasta que salga agua limpia.
 - ¡Atención! Antes de añadir la resina es necesario extraer el agua del taladro y limpiar el taladro con aire a presión sin aceite hasta que quede completamente seco (no aplica para agujeros realizados con taladros de percusión en aplicaciones sumergidas en agua).
- ▲ **Verificar que el relleno del taladro se produce desde el fondo del taladro para que no se formen burbujas de aire.**
 - Si es necesario, utilice las prolongaciones para alcanzar el fondo del taladro.
 - En aplicaciones por encima de la cabeza, utilice el accesorio HIT-SZ/IP y preste especial atención al introducir el elemento de fijación. Puede salir resina sobrante del taladro. Asegúrese de que la resina no gotee sobre el usuario.
 - Si se enrosca un nuevo mezclador en un cartucho ya abierto, las primeras aplicaciones deben también desecharse.
- ▲ **El incumplimiento de estas instrucciones puede llevar a una fijación incorrecta.**

Mortier de scellement pour ancrage de chevilles et d'armatures dans le béton

- ▶ Avant toute utilisation, bien lire le présent mode d'emploi ainsi que les directives de sécurité qui y sont mentionnées.
- ▶ Se reporter à la Fiche de données de sécurité.

Hilti HIT-RE 500 V3

Contient: produit de réaction: bisphénol-A-époichlorhydrine résines époxydiques MW≤700 (A); Triméthylpropane triglycidylether (A); 2-méthylpentane-1,5-diamine (B); 1,3-Benzènediméthanimine (B);



(A,B)



(A,B)



(A)

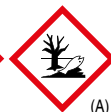

(A)



Danger

H314 Provoque des brûlures de la peau et des lésions oculaires graves.(A,B)

H317 Peut provoquer une allergie cutanée.(A,B)

H335 Peut irriter les voies respiratoires (A,B)

H360 Peut nuire à la fertilité (A)

H411 Toxique pour les organismes aquatiques, entraîne des effets néfastes à long terme.(A)

P280 Porter des gants de protection/des vêtements de protection/un équipement de protection des yeux/du visage.

P260 Ne pas respirer les vapeurs.

P303+P361+P353 EN CAS DE CONTACT AVEC LA PEAU (ou les cheveux): enlever immédiatement les vêtements contaminés. Rincer la peau à l'eau/se doucher.

P305+P351+P338 EN CAS DE CONTACT AVEC LES YEUX: rincer avec précaution à l'eau pendant plusieurs minutes. Enlever les lentilles de contact si la victime en porte et si elles peuvent être facilement enlevées.Continuer à rincer.

P333+P313 En cas d'irritation ou d'éruption cutanée: consulter un médecin.

P337+P313 Si l'irritation oculaire persiste: consulter un médecin.

Équipement de protection recommandé :

Protection des yeux : Lunettes de protection hermétiques p. ex. : réf. 02065449 Lunettes de sécurité PP EY-CA NCH claires ; réf. 02065591 Masque de protection PP EY-HA R HC/AF clair ;

Protection des mains : EN 374 Éviter un contact direct avec le produit chimique / le produit / la préparation à l'aide de mesures d'organisation.

Le choix final de l'équipement de protection adéquat relève de la seule responsabilité de l'utilisateur.

Indications de recyclage

Emballages vides

- ▶ Laisser la buse mélangeuse vissée et procéder à l'élimination par le biais du système de collecte national Point Vert.
 - ou code déchets EAK : 15 01 02 Emballages en plastique.

Emballages pleins/à moitié vides :

- ▶ Les apporter à un centre de collecte des matières dangereuses conformément aux dispositions administratives.
 - Code déchets EAK : 20 01 27* Peintures, encres d'impression, colles et résines artificielles, contenant des substances dangereuses.
 - ou code déchets EAK : 08 04 09* Résidus de colles et composants pour joints, contenant des solvants organiques ou d'autres substances dangereuses.

Contenu : 1400 ml / 47.3 fl.oz

Poids: 1980 g / 69.8 oz



Garantie: pour tous détails concernant la garantie, consulter les conditions de vente Hilti.

Le non respect de ces instructions de pose, l'utilisation de chevilles autres qu'Hilti, la pose dans un béton faible ou matériau ou des applications particulières peuvent avoir un impact sur la sécurité et la performance de la fixation.

Information produit

- Le présent mode d'emploi doit toujours être conservé avec le produit.
- Ne pas donner le produit à un autre utilisateur sans lui fournir le mode d'emploi.
- **Fiche de données de sécurité :** Avant toute utilisation, prendre connaissance des informations de sur les matériaux.
- **Date de péremption :** Contrôler la date de péremption (mois/année) imprimée sur le raccord de la cartouche. Ne plus utiliser un produit dont la date de péremption est dépassée.
- **Température des recharges en cours d'utilisation :** de +5 °C à 40 °C / 41 °F à 104 °F.
- **Conditions de transport et de stockage :** dans un endroit frais, sec et à l'abri de la lumière à une température de +5 °C à 25 °C / 41 °F à 77 °F.
- En cas d'applications qui ne sont pas décrites dans le présent mode d'emploi ou hors plage de valeurs spécifiées, s'adresser à Hilti.
- **Les cartouches souples entamées doivent être réutilisées dans l'intervalle d'une semaine.** Pour ce faire, laisser la cartouche souple avec l'embout mélangeur vissé dans le pistolet à injecter et ne pas faire revenir en arrière le piston de compression. Désolidariser l'alimentation en pression et stocker conformément à la réglementation. Avant réutilisation, visser une nouvelle buse mélangeuse et à nouveau, jeter le mortier extrudé lors des premières pressions.

AVERTISSEMENT

- ▲ En cas de manient non conforme, il y a risque de projection du mortier. Tout contact des yeux avec le mortier peut entraîner des lésions irréversibles !**
 - Lors du travail, porter une protection des yeux étanche, des gants et des vêtements de protection !
 - Ne jamais commencer l'extrusion si la buse mélangeuse n'est pas vissée !
 - Lorsque vous utilisez le tube prolongateur: la première décharge de la résine doit se faire à partir du mélangeur (et non pas du tube prolongateur flexible).
 - Avant de commencer l'extrusion d'une nouvelle cartouche souple, visser une nouvelle buse mélangeuse. Vérifier qu'elle est bien en place.
 - Attention ! Ne jamais dévisser la buse mélangeuse lorsque le système est sous pression. Utiliser exclusivement le type de mélangeur fourni avec le mortier. Ne modifier la buse mélangeuse en aucun cas.
 - Vérifier que la cartouche souple et le porte-cartouches ne sont pas endommagés – en particulier, s'ils sont tombés ! Les cartouches qui sont tombées, même si elles avaient déjà été placées dans le porte-cartouches, risquent de provoquer des dysfonctionnements.
 - Ne jamais utiliser de cartouches souples endommagées ni de porte-cartouches endommagés/très encrassés.
- ▲ Mauvaise fixation/défaillance du chevillage à cause d'un nettoyage insuffisant du trou foré. Avant de procéder à l'injection, s'assurer que le trou foré est exempt de débris de perçage, poussières, eau, glace, huile, graisse ou autres contaminants.**
 - Les mèches creuses Hilti TE-CD, TE-YD doivent être associées à un modèle d'aspirateur Hilti bien entretenu d'une capacité d'aspiration (débit volumétrique) conforme à la spécification du tableau des accessoires.
 - Soufflage du trou foré – souffler avec de l'air comprimé exempt d'huile, jusqu'à ce que l'air sortant soit exempt de toute poussière.
 - Rinçage du trou foré – rincer le trou à l'eau à pression de conduite normale jusqu'à ce que de l'eau propre ressorte.
 - Important ! Avant de remplir de mortier, évacuer l'eau du trou foré et le souffler avec de l'air comprimé exempt d'huile jusqu'à ce qu'il soit entièrement sec (Ne convient pas au trous forés au perforateur à percussion lors d'applications subaquatiques).
- ▲ Veiller à ce que le remplissage se fasse à partir du fond du trou foré pour éviter la formation de bulles d'air.**
 - Si nécessaire, utiliser des prolongateurs pour atteindre le fond du trou.
 - En cas d'applications au plafond, utiliser l'accessoire HIT-SZ/IP et faire particulièrement attention lors de l'introduction de l'élément de fixation. L'excédent de mortier peut ressortir du trou foré. Veiller alors à ce que celui-ci ne goutte pas sur l'opérateur.
 - Si une nouvelle buse mélangeuse est utilisée avec une cartouche déjà entamée, jeter également les premières pressions de mortier extrudé.
- ▲ Le non-respect des instructions peut entraîner une défaillance du chevillage!**

Sistema de ancoragem química para a fixação de ferros de armadura e ancoragens em betão

- ▶ Antes de utilizar este produto, siga as instruções de utilização e as precauções de segurança obrigatórias por lei.
- ▶ Consulte a Ficha de Informação de Segurança de Produtos Químicos para este produto.

Hiti HIT-RE 500 V3

Contém: produto de reacção: bisfenol-A-(epicloridrina) MG≤700 (A); Trimethylolpropane triglycidylether (A); 2-metilpentano-1,5-diamina (B); 1,3-Benzenodimetanamina (B);



(A,B)



(A,B)



(A)



(A)



Perigo

- H314 Provoca queimaduras na pele e lesões oculares graves.(A,B)
H317 Pode provocar uma reacção alérgica cutânea.(A,B)
H335 Pode provocar irritação das vias respiratórias (A,B)
H360 Pode afectar a fertilidade (A)
H411 Tóxico para os organismos aquáticos com efeitos duradouros.(A)

P280 Usar luvas de protecção/vestuário de protecção/protecção ocular/protecção facial.
P260 Não respirar as vapores.

P303+P361+P353 SE ENTRAR EM CONTACTO COM A PELE (ou o cabelo): espirar/retirar imediatamente toda a roupa contaminada. Enxaguar a pele com água/tomar um duche.

P305+P351+P338 SE ENTRAR EM CONTACTO COM OS OLHOS: enxaguar cuidadosamente com água durante vários minutos. Se usar lentes de contacto, retire-as, se tal lhe for possível. Continuar a enxaguar.

P333+P313 Em caso de irritação ou erupção cutânea: consulte um médico.

P337+P313 Caso a irritação ocular persista: consulte um médico.

Equipamento de protecção recomendado:

Protecção dos olhos: óculos de protecção por ex.: #02065449 Óculos de segurança PP EY-CA NCH claro; #02065591 Goggles PP EY-HA R HC/AF claro;

Protecção das mãos: EN 374 ; Deve-se evitar o contacto directo com o químico / o produto / o preparado através de medidas organizadas.

A escolha final dos equipamentos de protecção apropriados é da responsabilidade do utilizador

Nota sobre reciclagem

Cartuchos vazios

- ▶ Deixar o misturador enroscado e remover através dos sistemas de recolha nacionais, Ponto Verde – ou Código CER: 150102 Embalagens de plastic.



Cartuchos semiusados/novos:

- ▶ Remover de acordo com as normas e regulamentações legais sobre resíduos especiais.
 - Código CER: 20 01 27* Tintas, produtos adesivos, colas e resinas, contendo substâncias perigosas.
 - ou Código CER: 08 04 09* Resíduos de colas ou vedantes, contendo solventes orgânicos ou outras substâncias perigosas.

Conteúdo: 1400 ml / 47.3 fl.oz

Peso: 1980 g / 69.8 oz

Garantia: Para informações sobre a garantia, consulte os termos e condições de venda padrão da Hilti.

O não cumprimento destas instruções de colocação, a utilização de ancoragens que não sejam da Hilti, as condições fracas ou duvidosas do betão, ou aplicações fora do comum podem afectar a segurança ou a eficácia das fixações.

Dados informativos sobre o produto

- Guarde estas instruções de utilização sempre em conjunto com o produto.
- Entregue o produto a outras pessoas apenas juntamente com as instruções de utilização.
- **Ficha de Informação de Segurança de Produtos Químicos:** antes de iniciar os trabalhos, tenha em consideração a Ficha de Informação de Segurança de Produtos Químicos*
- **Prazo de validade:** veja o prazo de validade (mês/ano) na peça de junção do cartucho. Não utilize produtos cujo prazo de validade se encontre ultrapassado.
- **Temperatura do cartucho durante a utilização:** entre +5 °C e 40 °C / 41 °F e 104 °F.
- **Condições de transporte e armazenamento:** em lugar fresco, seco e ao abrigo da luz, entre +5 °C e 25 °C / 41 °F e 77 °F.
- Em caso de aplicações que não se encontrem descritas nas presentes instruções de utilização ou estejam fora das especificações, é favor dirigir-se à Hilti.
- **As sobras de cartuchos parcialmente usados devem ser aplicadas num prazo de uma semana.** Para o efeito, deixar o cartucho, com misturador enroscado, no dispensador e não reduzir a pressão. Desligar a alimentação de pressão e armazená-lo de acordo com as instruções. Antes da reutilização, enrosque um misturador novo e não utilize novamente a resina inicial.

A AVISO

▲ No caso de manuseamento incorrecto, é possível que seja injectada resina. O contacto da resina com os olhos pode provocar lesões oculares permanentes!

- Durante a realização de trabalhos, use óculos de protecção que fiquem bem justos, luvas de protecção e roupa de trabalho!
- Nunca comece a aplicação sem que o misturador esteja enroscado!
- Quando utilizar a mangueira de extensão: O descarte inicial de resina deve ser feito através do misturador fornecido (e não através da mangueira de extensão).
- Antes da aplicação de um novo cartucho, enrosque um misturador novo. Certifique-se de que está bem apertado.
- Cuidado! Nunca desenrosque o misturador quando o sistema está sob pressão. Utilize apenas o tipo de misturador fornecido com a resina. Não modifique o misturador de forma alguma.
- Comprovar se o cartucho e o suporte não estão danificados – em particular depois de terem caído ao chão! Cartuchos que tenham caído ao chão, mesmo depois de já estarem inseridos no respectivo suporte, podem causar anomalias.
- Nunca utilize cartuchos danificados e/ou suportes danificados ou sujos.

▲ Valores de retenção deficientes/falha da fixação devido a limpeza insuficiente do furo. Os furos devem estar secos e livres de material de perfuração, pó, água, gelo, óleo, gordura ou outras impurezas antes de efectuar a injeção.

- A brocas de perfuração ocas Hilti TE-CD e TE-YD têm de ser usadas em conjunto com um aspirador Hilti em boas condições de funcionamento e com o modelo e capacidade de aspiração (débito volumétrico) especificados na tabela dos acessórios.
- Limpar o furo por sopra – limpe o furo por sopra com ar isento de óleo, até que o ar saia sem pó.
- Lavar o furo – lave com uma mangueira com pressão normal, até sair água limpa.
- Importante! Antes de preencher com resina, retire a água do furo e sopra com ar isento de óleo até estar totalmente seco (Não utilizável em furos subaquáticos executados com percussão).

▲ Certifique-se de que o enchimento do furo é efectuado a partir do fundo, para que não se formem bolhas de ar.

- Se necessário, utilize os prolongadores para alcançar o fundo do furo.
- No caso de aplicações em suspensão, utilize o acessório HIT-SZ/IP e preste especial atenção ao inserir o elemento de fixação. Pode sair resina em excesso do furo. Certifique-se de que não pinga resina sobre o utilizador.
- Se for enroscado um misturador novo num cartucho já aberto, também não utilize o produto das primeiras bombadas.

▲ A não observação das instruções pode conduzir à falha da fixação!

- AR** Hilti Argentina S.R.L.
Profesor Manuel García 4760
B1605 BIB - Munro
AR-Buenos Aires
Tel +54 11 4721 4400
Fax +54 11 4721 4410
- BR** Hilti do Brasil Comercial Ltda.
Av. Ceci, 426-Centro
Empresarial Tamboré
06460-120 Barueri, SP
Tel +55 11 4134 9000
Fax +55 11 4134 9072
- CA** Hilti (Canada) Corp.
2360 Meadowpine Boulevard
Mississauga, Ontario L5N 6S2
Tel +1 905 813 920
Fax +1 905 813 9009
- CL** Hilti Chile Ltda.
Av. Apoquindo 4501, piso 13
Las Condes 7550000
Santiago
Tel +562 655 3000
Fax +562 426 1974
- MX** Hilti Mexicana, S.A. de C.V.
Jaime Balmes 8, Oficina 102,
1er Piso
Col. Los Morales Polanco
Del. Miguel Hidalgo
MEX-Mexico City 11510
Tel +5255 5387-1600
Fax +5255 5281 1419
- PE** Química Suiza S.A.
2577 Av. República de Panamá
Apartado 3919
PE- Lima 100
Tel +511 211 4423
Fax +51 1 211 4050
- PR** Hilti Caribe, LLC
The Palmas Village #3,
Carr. 869 KM 2, Palmas
Industrial Park
Cataño, PR 00962
Tel +1-787 936-7060
Fax +1 787 936-7065
- US** Hilti Inc.
5400 South 122nd East Ave.
US-Tulsa, OK 74146
Tel +1 918 872 3000
- VE** Hilti Venezuela, S.A.
Calle Pascuale Giorgio, 3era.
Transversal, Edf. Segre,
2do Piso, Ala Norte, Los Ruices
VE-Caracas 1071
Tel +58 212 232 42 43
Fax +58 212 203 4310

Info | Shop



[http://hilti15.pxltv.net/
toolselectorv2/index.php](http://hilti15.pxltv.net/toolselectorv2/index.php)

www.hilti.group

Hilti = registered trademark of Hilti Corporation, Schaan, Liechtenstein

© 2018

Right of technical changes reserved S.E. & O,

Made in Germany



414867