



TREATED PARALLAM[®] PLUS PSL BEAMS, HEADERS AND COLUMNS



Featuring Trus Joist[®] Parallam[®] PSL
with Preservative Protection

- Columns and posts are ideal for ground and fresh water contact and saltwater splash applications
- Beams and headers are ideal for exterior, above ground use
- Protects against termites and decay-causing fungi
- Treated throughout the cross section
- Kiln dried after treatment
- 30-year limited warranties





The products in this guide are readily available through our nationwide network of distributors and dealers. For more information on applications or other Trus Joist® products, contact your Weyerhaeuser representative.

Code Evaluations:
Intertek CCRR-0475

TABLE OF CONTENTS

Warranty Information	2
Product Features and Sizes	3
Treated Parallam® Plus PSL Applications	4
Design Properties	5
Hardware Recommendations and Bearing Requirements	6
Beam Load Tables	7-8
Decks	9
Columns	10
Allowable Holes	10
Column Details	11
Flashing Tape for Exposed Exterior Deck Beams	12
Cladding Information	13
Q&A	14-15



Why Choose Treated Parallam® Plus PSL?

Wood is naturally susceptible to attack by wood-destroying fungi and termites, so any wood product used in wet-service conditions or exposed exterior applications requires preservative treatment to protect it from degradation and ensure an extensive service life.

Weyerhaeuser has partnered with Koppers Performance Chemicals Inc. to create Treated Parallam® Plus PSL, which effectively resists fungal decay and termite attack. Treated Parallam® Plus PSL is suitable for applications that are exposed directly to weather and water—such as decks, pavilions, and pool enclosures—and direct ground contact applications like deck posts. Column members can even be used in saltwater splash applications.

DURABILITY AGAINST FUNGAL DECAY—GUARANTEED

Treated Parallam® Plus PSL is backed by two 30-year limited warranties to provide long-term peace of mind. As the manufacturer of Parallam® PSL, Weyerhaeuser warrants Treated Parallam® Plus PSL against manufacturing defects. Koppers Performance Chemicals Inc. warrants against termites and fungal decay. For more details, see our *Treated Parallam® Plus PSL Limited 30-Year Warranty*, TJ-7101, available from your Weyerhaeuser representative or online at weyerhaeuser.com/woodproducts.

EXCLUSIVE & LIMITED 30-YEAR WARRANTY

Trus Joist® Treated Parallam® Plus PSL

When properly stored, installed and maintained per Weyerhaeuser's published instructions, Treated Parallam Plus PSL (Product) is warranted, on the terms and conditions described below, against manufacturing defects by Weyerhaeuser Mill Company (Weyerhaeuser), the manufacturer of the Product, and its agents against termites and fungal decay by Koppers Performance Chemicals Inc. (KPC), a leading provider of wood preservatives for pressure-treated wood products. Treated Parallam Plus PSL columns are treated with KPC's Conditioned Copper Azoloxone Type C wood preservative (CCA-C), and Parallam Plus PSL beams and joists are treated with KPC's Microencapsulated Copper Azole wood preservative (MCA).

This Limited Warranty is valid for a period of 30 years from the date of purchase (Warranty Period) and is available to the initial owner of record of the real property on which the Product was installed ("Owner") and is transferable to any subsequent Owner, subject to the terms and conditions below.

WEYERHAEUSER TRUS JOIST® TREATED PARALLAM® PLUS PSL 30-YEAR LIMITED WARRANTY

Weyerhaeuser warrants the Product for adequacy of design values as published by Weyerhaeuser in its Treated Parallam® Plus PSL Specifier's Guide (TJ7102) and against Delamination and manufacturing defects. "Delamination" means an extensive separation of strands within the Product, and excludes minor localized edge checking or loose strands on the surface of the Product.

The sole obligation of Weyerhaeuser and its exclusive remedy available under this Limited Warranty, for inadequacy of design values, Delamination, or manufacturing defects, is replacement of the defective Product with new Product. Replacement material will be delivered to the project site at Weyerhaeuser's expense. Owner shall be solely responsible for all related costs and expenses in connection with removing nonconforming products, installation or reinstallation, labor, and other costs associated with the replacement materials.

Conditions and Exclusions

This Limited Warranty provided by Weyerhaeuser hereunder is subject to the "General Conditions and Exclusions" below. In addition, this Limited Warranty does not cover the following:

- Damage to Product resulting from fire, natural disaster or any other cause beyond Weyerhaeuser's control.
- Damage to Product resulting from misuse, improper product application or installation of the Product, or noncompliance with the installation instructions, applicable building code, or generally accepted construction practices.
- Defects in the structure due to construction, installation or manufactured sub-assembly.
- Any alterations to the Product after the original installation.
- Utility structures, such as utility poles and cross-arms.
- Damage due to fungal decay or termite attack (see the KPC Limited Warranty below).

See also "General Terms and Conditions" on reverse.

How do I submit a warranty claim?

Within thirty (30) days of discovery of a defect, send photographs and a description of the Product damage along with the purchase invoice, proof of purchase certificate, or proof of stamp label to:

Weyerhaeuser Technical Support Group
225 Occidental Avenue South
Seattle, Washington 98134
Email: techsupport@weyerhaeuser.com

KOPPERS PERFORMANCE CHEMICALS INC. 30-YEAR LIMITED WARRANTY AGAINST TERMITES AND FUNGAL DECAY

KPC warrants that its CCA-C and MCA wood preservatives will protect the Product against damage by termites or Fungal Decay that would make the Product structurally unfit for the application for which it was properly installed. "Fungal Decay" means attack by wood-destroying fungi that disrupts the wood fiber matrix and excludes aesthetic surface rot, mildew, or fungi associated with the appearance or weathering of wood, "weathering" as used herein being of any type.

The only obligation of KPC and its exclusive remedy available under this Limited Warranty, for Product that is made structurally unfit for the application for which it was intended by termites or Fungal Decay is replacement of the damaged Product (damaged Product only) with new Product. Owner shall be solely responsible for all related costs and expenses in connection with removing any nonconforming products, installation or reinstallation, labor, and other costs associated with the replacement materials.

Conditions and Exclusions

The Limited Warranty provided by KPC hereunder is subject to the "General Conditions and Exclusions" below. In addition, this Limited Warranty does not cover damage to Product:

- If any part of the Product has been used in contact with untreated or treated material that has been used in an improper application, or in contact with any other construction with any evidence of decay.
- If the Product has been re-sawn in depth or thickness (other than cut to length) or surfaced (sanded/planned/etc), but excluding light surface sanding.
- Resulting from Delamination or manufacturing defects of the Product (see the Weyerhaeuser Limited Warranty above).
- Other than due to termite attack or fungal decay.

See also "General Terms and Conditions" on reverse.





WARNING: This product can expose you to chemicals including wood dust which are known to the State of California to cause cancer, and methanol, which are known to the State of California to cause birth defects or other reproductive harm. Drilling, sawing, sanding or machining wood products can expose you to wood dust. Avoid inhaling wood dust or use a dust mask or other safeguards for personal protection. For more information go to www.P65Warnings.ca.gov and www.P65Warnings.ca.gov/wood.

PRODUCT FEATURES AND SIZES

Trus Joist® Treated Parallam® Plus PSL

- Preservative treatment penetrates all the way to the core of the cross section
- Kiln dried after treatment
- Provides termite and fungal decay protection

Treated Parallam® Plus PSL beams and columns are treated with waterborne preservatives from Koppers Performance Chemicals Inc.. They are treated and dried only at Weyerhaeuser-authorized treatment facilities.

Treated beam and header products are suitable for exposed exterior applications such as decks, pavilions, and pool enclosures. Treated column products are suitable for direct ground contact applications such as deck posts and construction poles for elevated house construction, as well as for saltwater splash applications. See Features and Use Characteristics table below for more detail.



Features and Use Characteristics for Treated Parallam® Plus PSL Beams, Headers, and Columns

Feature/Use Characteristics	Parallam® Plus PSL	
	Beams and Headers	Columns
AWPA Use Category	UC3B or lower	UC4B or lower
Saltwater splash permitted	No	Yes
Treatment	MCA	CCA
Kiln dried after treating	Yes (KD 19)	Yes (KD 19)
Fungal decay protection	Yes	Yes
Termite protection	Yes	Yes
Corrosion-resistant hardware required	Yes	Yes
Suitable for interior applications	Yes	Yes
Paintable or stainable	Yes	Yes

Available Widths and Depths of Treated Parallam® Plus PSL

Treated Parallam® Plus PSL beams and headers are available in the following sizes:

Widths: 3½" and 5¼"

Depths: 9¼", 11⅞", 14", and 16"

Treated Parallam® Plus PSL columns and posts are available in the following sizes:

3½" x 5¼" 5¼" x 5¼" 7" x 7"

Some sizes may not be available in your region.

Contact your Weyerhaeuser representative for dealer locations, available sizes, and lead times for treatment and delivery.

Treated Parallam® Plus PSL has an inherently industrial finish. Surface preparation may be required to achieve an acceptable architectural finish. Routine maintenance, such as the application of quality exterior stains and sealers, is required to improve and maintain the finish. Deck flashing tape is recommended for the top edge of beams used in exposed deck applications to enhance moisture protection.

In order for Treated Parallam® Plus PSL to perform as described, the product must maintain its original cross section. Treated Parallam Plus® beams, headers and columns may be cut to length, but must not be resawn in depth or thickness.

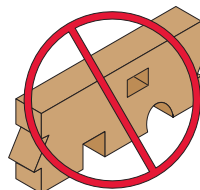

DO NOT cut, notch, or drill holes in Treated Parallam® Plus PSL except as indicated in the Trus Joist® Beams, Headers, and Columns Specifier's Guide, TJ-9000.

TREATED PARALLAM® PLUS PSL APPLICATIONS

Where to Use Treated Parallam® Plus PSL

The American Wood Protection Association (AWPA) created Use Categories (UC) to characterize the end-use environments that require treated wood products.

Treated Parallam® Plus PSL may be used for interior, dry or damp, above ground applications (AWPA UC1 and AWPA UC2) to help protect against termites.

Treated Parallam® Plus PSL is also suitable for exterior applications where a structural member is either partly or entirely located outside of the waterproof building envelope and exposed directly to weather (AWPA UC3) and ground contact (AWPA UC4). In these applications it can help protect against both termites and fungal decay.



Parallam® PSL products enter an airtight treatment cylinder—a highly controlled, pressurized environment where they are exposed to the treatment process.

How to Specify Treated Parallam® Plus PSL

Using the table below:

Step 1: Verify the appropriate **AWPA Use Category** for your application.

Step 2: Verify the associated moisture content for the corresponding **Service Level** meets the application.

Step 3: Design the members using the Service Level from Step 2 with one of the following:

- Allowable design stresses on page 5
- Load and application tables in this guide (only for SL0, SL1 and SL2)
- ForteWEB® software

Use Categories and Service Levels

AWPA Use Category ⁽¹⁾	Service Conditions	Use Environment	Typical Applications	Treated Parallam® Plus PSL Acceptable Conditions		
				Service Level ⁽²⁾	MCA Beams and Headers	CCA Columns
UC1	Interior Construction, Above Ground, dry	Continuously protected from weather or other sources of moisture	Interior termite resistant construction	SL0 or SL1	✓	✓
UC2	Interior Construction, Above Ground, damp	Protected from weather, but may be subject to sources of moisture	Sill Plates, Crawl Space Beams	SL0 or SL1	✓	✓
UC3A	Exterior Construction, Above Ground, rapid runoff	Exposed to all weather cycles, not exposed to prolonged wetting	Coated millwork, siding and trim	Not Applicable	Not Applicable	Not Applicable
UC3B	Exterior Construction, Above Ground, poor water runoff	Exposed to all weather cycles, including intermittent wetting, but with sufficient air circulation so wood can readily dry	Above ground joists and beams for decks and freshwater docks	SL2	✓	✓
UC4A	Ground Contact or Fresh Water, Non-critical Components	Exposed to all weather cycles, including continuous or prolonged wetting	Fence and deck posts	SL3	Not Permitted	✓
UC4B	Ground Contact or Fresh Water, Critical Components or difficult replacement	Exposed to all weather cycles, including continuous or prolonged wetting, high decay potential includes salt water splash	Embedded deck posts, freshwater dock support posts, and wood used in salt water splash zones	SL3	Not Permitted	✓
UC4C	Ground Contact or Fresh Water, Critical Structural Components	Exposed to all weather cycles, severe environments	Foundation Piling	NA	Not Permitted	Not Permitted
UC5A	Salt or brackish water and adjacent mudzone	Continuous marine exposure	Piling and Bulkheads	NA	Not Permitted	Not Permitted
--	Flood Zones		Posts and Beams Below BFE ⁽³⁾	Flood Damage Resistant Material ⁽³⁾	✓	✓

(1) Refer to AWPA Book of Standards (Standard U1, Table 2-1) for a complete description of use category designations and typical applications.

(2) Treated Parallam® Plus PSL Service Level takes into account moisture content ranges that affect design properties. The equilibrium moisture content (EMC) for each service level is as follows: SL0 ≤ 12%, 12% < SL1 ≤ 16%, 16% < SL2 ≤ 28%, and SL3 > 28%.

(3) Treated Parallam® Plus PSL is considered a flood-damage-resistant material, permitted for use below the base flood elevation (BFE) to satisfy requirements of the National Flood Insurance Program (NFIP). For more information contact Weyerhaeuser.

DESIGN PROPERTIES

Allowable Design Stresses for Beams and Columns (100% Load Duration)

Treated Parallam® Plus PSL	Design Service Level ⁽¹⁾	Orientation	E Modulus of Elasticity ⁽⁴⁾⁽⁵⁾ (x 10 ⁶ psi)	E _{min} Adjusted Modulus of Elasticity ⁽⁶⁾ (x 10 ⁶ psi)	F _b Flexural Stress ⁽⁷⁾ (psi)	F _v Horizontal Shear Parallel to Grain (psi)	F _{c⊥} Compression Perpendicular to Grain ⁽⁸⁾ (psi)	F _t Tension Stress ⁽⁹⁾ (psi)	F _c Compression Parallel to Grain (psi)
Beams ⁽²⁾ (MCA)	SL0	Beam	1.69	0.860	2,370	225	415	1,785	2,175 ⁽¹⁰⁾
		Plank	1.79	0.911	2,290	165	255		
	SL1	Beam	1.65	0.840	2,275	215	380	1,745	2,005 ⁽¹⁰⁾
		Plank	1.76	0.893	2,205	160	235		
	SL2	Beam	1.49	0.759	1,885	180	240	1,595	1,310 ⁽¹⁰⁾
		Plank	1.61	0.819	1,855	130	150		
SL3	Beam	1.39	0.708	1,675	150	170	1,480	1,050 ⁽¹⁰⁾	
	Plank	1.50	0.763	1,605	110	90			
Columns ⁽³⁾ (CCA)	SL0	Beam	1.52	0.774	2,045	180	335	1,545	1,875
		Plank	1.61	0.820	1,965	150	225		
	SL1	Beam	1.49	0.756	1,960	170	305	1,515	1,725
		Plank	1.58	0.804	1,890	145	205		
	SL2	Beam	1.34	0.683	1,625	140	195	1,380	1,130
		Plank	1.45	0.737	1,590	120	135		
	SL3	Beam	1.25	0.637	1,445	120	135	1,280	905
		Plank	1.35	0.987	1,375	100	75		

(1) The equilibrium moisture content (EMC) for each Design Service Level is as follows: SL0 ≤ 12%, 12% < SL1 ≤ 16%, 16% < SL2 ≤ 28%, and SL3 > 28%.

(2) Beams are defined as those products which are 2.0E Parallam PSL prior to treatment.

(3) Columns are defined as those products which are 1.8E Parallam PSL prior to treatment.

(4) To properly calculate deflections for the full range of typical SCL span and loading applications, bending and shear deflections must be considered.

Use the following equation for simple span, uniformly loaded beams:

$$\Delta = \frac{270 wL^4}{Ebd^3} + \frac{28.8 wL^2}{Ebd}$$

Where: Δ = deflection (in.) w = uniform load (plf)
 L = span (feet) b = beam thickness (in.)
 d = beam depth (in.) E = modulus of elasticity (psi)

For other span and loading conditions, use engineering mechanics to account for both bending and shear deflection or use ForteWEB® software.

(5) Total deflection under long-term loading may be estimated in accordance with NDS® Section 3.5.2. Use K_{CR} = 1.5 for SL0 and SL1 and K_{CR} = 2.0 for SL2 and SL3.

(6) Reference modulus of elasticity for beam and column stability calculation per NDS®.

(7) For 12" depth. For other depths, multiply by (12/d)^{0.111}

(8) F_{c⊥} must not be increased for duration of load.

(9) Reference tension design values are based on a standard length of 4 feet. For lengths longer than 4 feet multiply F_t by the following adjustment:

Parallam® PSL: (4/L)^{0.056}, where L is length in feet.

(10) For beam products used in column applications, capacity can be determined using the provisions of Chapter 15 of the NDS in conjunction with the published F_c value above and a minimum eccentricity, e₂, applied to the narrow face of the member.

$$e_2 = t/6 + 5L^2/4608$$

Where:

e₂ = Eccentricity applied parallel to the narrow face of the member, inches

t = Member thickness, inches

L = Unbranched column length about the weak axis, feet

General Notes

- Surface checking is an inherent characteristic of Treated Parallam® Plus PSL and is common to all wood products. The design values in this guide account for surface checking.
- Lateral support is required at bearing and along the span at 24" on center maximum.

Beam Orientation

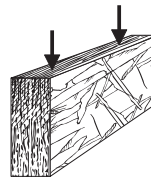

Plank Orientation

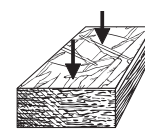

DESIGN PROPERTIES

Connection Design Adjustment Factors⁽¹⁾

Service Level of Beam or Column Application ⁽²⁾	Nails (Installed in Face or Edge)		Screws (Installed in Face or Edge)		Bolts and Lag Screws ⁽³⁾ (Installed in Face)
	Lateral	Withdrawal	Lateral	Withdrawal	Lateral
SL0	0.70	0.81 ⁽⁴⁾	0.70	0.81	0.74 ⁽⁶⁾
SL1	0.66	0.79 ⁽⁴⁾	0.66	0.79	0.69 ⁽⁶⁾
SL2	0.49	0.25 ⁽⁵⁾	0.49	0.70	0.50 ⁽⁶⁾
SL3	0.36	0.25 ⁽⁵⁾	0.36	0.64	0.39

(1) Adjustment factors are applied after connection is designed with SG = 0.50. Connection design adjustment factors above are used in lieu of NDS Wet Service Factor, C_m.

(2) The equilibrium moisture content (EMC) associated with each Design Service Level is as follows: SL0 ≤ 12%, 12% < SL1 ≤ 16%, 16% < SL2 ≤ 28%, and SL3 > 28%.

(3) Bolts and lag screws must not be installed into the edge of Treated Parallam® Plus PSL.

(4) If product moisture content is expected to temporarily exceed SL1, use connection design adjustment factor of 0.25 per NDS®.

(5) Adjustment factor assumes that moisture fluctuations between dry conditions (SL0 or SL1) and wet conditions (SL2 or SL3) may occur in service. If product moisture content will be continuously subject to SL2 or greater levels, use connection design adjustment factor of 0.70 for SL2 and 0.64 for SL3.

(6) Connection design adjustment factor shall be 0.40 to avoid drying induced splitting when a bolted connection is installed in wet material (SL2 or SL3) that is allowed to dry (SL0, SL1), subject to the exceptions noted in NDS Table 11.3.3, footnote 2 (single fastener or row, separate side member for each row).

Allowable Design Properties (100% Load Duration)

3½" Beams—Service Level 2

Design Property	Depth			
	9¼"	11⅞"	14"	16"
Moment (ft-lbs)	8,070	12,935	17,655	22,720
Shear (lbs)	3,885	4,990	5,880	6,720
Moment of Inertia (in. ⁴)	231	488	800	1,195
Weight (plf)	11.7	15.1	17.7	20.3

5¼" Beams—Service Level 2

Design Property	Depth			
	9¼"	11⅞"	14"	16"
Moment (ft-lbs)	12,105	19,405	26,485	34,080
Shear (lbs)	5,830	7,480	8,820	10,080
Moment of Inertia (in. ⁴)	346	733	1,201	1,792
Weight (plf)	17.6	22.6	26.6	30.4

HARDWARE RECOMMENDATIONS AND BEARING REQUIREMENTS

Hardware Recommendations

Due to the high moisture content typically present where Treated Parallam® Plus PSL is used, it is very important to use corrosion-resistant fasteners and connectors for all applications. Fasteners include nails, screws, and bolts. Connectors include joist hangers, post bases, and hurricane or mudsill anchors.

Fasteners and connectors must have a coating that will provide the required level of corrosion resistance for the treatment types, retention levels, and end use conditions for Treated Parallam® Plus PSL. Corrosion of fasteners and connectors are excluded from the Treated Parallam® Plus PSL limited warranty.

To ensure that you select the appropriate hardware, follow the hardware manufacturer's recommendation for AWP Use Category ≤ UC4A for columns and beams in exposed above ground applications. For columns exposed to salt water splash follow recommendations for > UC4A (UC4B). Fasteners and hardware must comply with building codes.

Beam Bearing Length Requirements—Service Level 2

Reaction	Treated Beam Width	
	3½"	5¼"
2,000	2½"	1¾"
4,000	5"	3 ¼"
6,000	7¼"	5"
8,000	9¾"	6½"
10,000	12"	8"
12,000	14½"	9¾"
14,000		11¼"
16,000		12¾"
18,000		14½"
20,000		16"

General Notes

- Minimum bearing length: 1½" at ends, 3½" at intermediate supports.
- Bearing across full beam width required.
- Interpolation between reaction loads is permitted for determining bearing lengths.

BEAM LOAD TABLES



How to Use Beam Load Tables on pages 7 and 8

1. Calculate total load and live load (neglect beam weight) on the beam or header in pounds per linear foot (plf).
2. Select appropriate **Span** (center-to-center of bearing).
3. Scan horizontally to find the proper width, and a depth with a capacity that exceeds actual total and live loads.
4. Review bearing length requirements to ensure adequacy.

Floor Load (PLF)—Service Level 2

Load Duration	Span	Condition	3½" Width				5¼" Width			
			9¼"	11¼"	14"	16"	9¼"	11¼"	14"	16"
100% Floor	8'	Total Load	906	924	924	924	1360	1387	1387	1387
		Live Load L/360	871	*	*	*	1306	*	*	*
		Min. End/Int. Bearing (in.)	4.4/10.9	4.5/11.3	4.5/11.3	4.5/11.3	4.4/10.9	4.5/11.3	4.5/11.3	4.5/11.3
	10'	Total Load	557	735	735	735	836	1103	1103	1103
		Live Load L/360	466	*	*	*	700	*	*	*
		Min. End/Int. Bearing (in.)	3.4/8.5	4.5/11.3	4.5/11.3	4.5/11.3	3.4/8.5	4.5/11.3	4.5/11.3	4.5/11.3
	12'	Total Load	326	609	609	609	489	914	914	914
		Live Load L/360	277	564	*	*	415	847	*	*
		Min. End/Int. Bearing (in.)	2.4/6	4.5/11.3	4.5/11.3	4.5/11.3	2.4/6	4.5/11.3	4.5/11.3	4.5/11.3
	14'	Total Load	204	429	519	519	306	644	779	779
		Live Load L/360	177	364	*	*	266	547	*	*
		Min. End/Int. Bearing (in.)	1.8/4.5	3.7/9.3	4.5/11.3	4.5/11.3	1.8/4.5	3.7/9.3	4.5/11.3	4.5/11.3
	16'	Total Load	134	288	452	452	202	432	678	678
		Live Load L/360	120	248	398	*	180	372	598	*
		Min. End/Int. Bearing (in.)	1.5/3.5	2.9/7.2	4.5/11.3	4.5/11.3	1.5/3.5	2.9/7.2	4.5/11.3	4.5/11.3
	18'	Total Load	91	200	329	399	137	300	493	599
		Live Load L/360	84	176	284	*	127	264	426	*
		Min. End/Int. Bearing (in.)	1.5/3.5	2.3/5.8	3.7/9.3	4.5/11.3	1.5/3.5	2.3/5.8	3.7/9.3	4.5/11.3
	20'	Total Load	64	143	238	355	96	214	357	533
		Live Load L/360	62	129	209	308	93	194	314	462
		Min. End/Int. Bearing (in.)	1.5/3.5	1.9/4.7	3/7.6	4.5/11.2	1.5/3.5	1.9/4.7	3/7.6	4.5/11.2
	24'	Total Load		77	132	201		116	198	302
		Live Load L/360		76	123	182		114	184	273
		Min. End/Int. Bearing (in.)		1.5/3.5	2.1/5.4	3.2/7.9		1.5/3.5	2.1/5.4	3.2/7.9
28'	Total Load			77	121		65	116	181	
	Live Load L/360			*	116		*	*	174	
	Min. End/Int. Bearing (in.)			1.6/4	2.4/5.9		1.5/3.5	1.6/4	2.4/5.9	
32'	Total Load				75			70	113	
	Live Load L/360				*			*	*	
	Min. End/Int. Bearing (in.)				1.8/4.6			1.5/3.5	1.8/4.6	

* Indicates **Total Load** value controls.

General Notes

- Table is based on:
 - Uniform loads (beam weight considered).
 - More restrictive of simple or continuous span.
 - Deflection criteria of L/240 total load and L/360 live load.
- Total load values meet the IBC deflection limit for floor beams for dead load to live load ratios up to 60%. Check local code for other deflection criteria.
- For deflection limits of L/240 and L/480, multiply **Live Load L/360** values by 1.5 and 0.75 respectively. The resulting live load must not exceed the total load shown.
- For continuous spans, ratio of short span to long span should be 0.4 or greater to prevent uplift.
- Lateral support is required at bearing and along the span at 24" on-center, maximum.
- For conditions beyond the scope of this table, including applications other than Service Level 2, use our ForteWEB® and Javelin® software or contact your Weyerhaeuser representative.

BEAM LOAD TABLES

Roof Load (PLF)—Service Level 2

Load Duration	Span	Condition	3½" Width				5¼" Width			
			9¼"	11⅞"	14"	16"	9¼"	11⅞"	14"	16"
115% Snow	8'	Total Load	924	924	924	924	1,387	1,387	1,387	1,387
		Live Load L/240	*	*	*	*	*	*	*	*
		Min. End/Int. Bearing (in.)	4.5/11.3	4.5/11.3	4.5/11.3	4.5/11.3	4.5/11.3	4.5/11.3	4.5/11.3	4.5/11.3
	10'	Total Load	719	735	735	735	1079	1103	1103	1103
		Live Load L/240	700	*	*	*	1050	*	*	*
		Min. End/Int. Bearing (in.)	4.4/10.9	4.5/11.3	4.5/11.3	4.5/11.3	4.4/10.9	4.5/11.3	4.5/11.3	4.5/11.3
	12'	Total Load	422	609	609	609	634	914	914	914
		Live Load L/240	415	*	*	*	623	*	*	*
		Min. End/Int. Bearing (in.)	3.1/7.8	4.5/11.3	4.5/11.3	4.5/11.3	3.1/7.8	4.5/11.3	4.5/11.3	4.5/11.3
	14'	Total Load	266	519	519	519	399	779	779	779
		Live Load L/240	266	*	*	*	399	*	*	*
		Min. End/Int. Bearing (in.)	2.3/5.8	4.5/11.3	4.5/11.3	4.5/11.3	2.3/5.8	4.5/11.3	4.5/11.3	4.5/11.3
	16'	Total Load	176	374	452	452	264	561	678	678
		Live Load L/240	*	372	*	*	*	559	*	*
		Min. End/Int. Bearing (in.)	1.8/4.5	3.7/9.3	4.5/11.3	4.5/11.3	1.8/4.5	3.7/9.3	4.5/11.3	4.5/11.3
	18'	Total Load	121	261	399	399	182	392	599	599
		Live Load L/240	*	*	*	*	*	*	*	*
		Min. End/Int. Bearing (in.)	1.5/3.6	3/7.4	4.5/11.3	4.5/11.3	1.5/3.6	3/7.4	4.5/11.3	4.5/11.3
	20'	Total Load	85	188	311	357	128	282	466	536
		Live Load L/240	*	*	*	*	*	*	*	*
		Min. End/Int. Bearing (in.)	1.5/3.5	2.4/6.1	3.9/9.8	4.5/11.3	1.5/3.5	2.4/6.1	3.9/9.8	4.5/11.3
	24'	Total Load		104	175	265	67	156	263	397
		Live Load L/240		*	*	*	*	*	*	*
		Min. End/Int. Bearing (in.)		1.7/4.3	2.8/6.9	4.1/10.2	1.5/3.5	1.7/4.3	2.8/6.9	4.1/10.2
28'	Total Load		60	105	161		90	157	242	
	Live Load L/240		*	*	*		*	*	*	
	Min. End/Int. Bearing (in.)		1.5/3.5	2/5.1	3/7.6		1.5/3.5	2/5.1	3/7.6	
125% Non-Snow	8'	Total Load	924	924	924	924	1387	1387	1387	1387
		Live Load L/240	*	*	*	*	*	*	*	*
		Min. End/Int. Bearing (in.)	4.5/11.3	4.5/11.3	4.5/11.3	4.5/11.3	4.5/11.3	4.5/11.3	4.5/11.3	4.5/11.3
	10'	Total Load	719	735	735	735	1079	1103	1103	1103
		Live Load L/240	700	*	*	*	1050	*	*	*
		Min. End/Int. Bearing (in.)	4.4/10.9	4.5/11.3	4.5/11.3	4.5/11.3	4.4/10.9	4.5/11.3	4.5/11.3	4.5/11.3
	12'	Total Load	422	609	609	609	634	914	914	914
		Live Load L/240	415	*	*	*	623	*	*	*
		Min. End/Int. Bearing (in.)	3.1/7.8	4.5/11.3	4.5/11.3	4.5/11.3	3.1/7.8	4.5/11.3	4.5/11.3	4.5/11.3
	14'	Total Load	266	519	519	519	399	779	779	779
		Live Load L/240	266	*	*	*	399	*	*	*
		Min. End/Int. Bearing (in.)	2.3/5.8	4.5/11.3	4.5/11.3	4.5/11.3	2.3/5.8	4.5/11.3	4.5/11.3	4.5/11.3
	16'	Total Load	176	374	452	452	264	561	678	678
		Live Load L/240	*	372	*	*	*	559	*	*
		Min. End/Int. Bearing (in.)	1.8/4.5	3.7/9.3	4.5/11.3	4.5/11.3	1.8/4.5	3.7/9.3	4.5/11.3	4.5/11.3
	18'	Total Load	121	261	399	399	182	392	599	599
		Live Load L/240	*	*	*	*	*	*	*	*
		Min. End/Int. Bearing (in.)	1.5/3.6	3/7.4	4.5/11.3	4.5/11.3	1.5/3.6	3/7.4	4.5/11.3	4.5/11.3
	20'	Total Load	85	188	311	357	128	282	466	536
		Live Load L/240	*	*	*	*	*	*	*	*
		Min. End/Int. Bearing (in.)	1.5/3.5	2.4/6.1	3.9/9.8	4.5/11.3	1.5/3.5	2.4/6.1	3.9/9.8	4.5/11.3
	24'	Total Load		104	175	265	67	156	263	397
		Live Load L/240		*	*	*	*	*	*	*
		Min. End/Int. Bearing (in.)		1.7/4.3	2.8/6.9	4.1/10.2	1.5/3.5	1.7/4.3	2.8/6.9	4.1/10.2
28'	Total Load		60	105	161		90	157	242	
	Live Load L/240		*	*	*		*	*	*	
	Min. End/Int. Bearing (in.)		1.5/3.5	2/5.1	3/7.6		1.5/3.5	2/5.1	3/7.6	

* Indicates Total Load value controls.

See page 7 for how to use this table.

General Notes

- Table is based on:
 - Uniform loads (beam weight considered).
 - More restrictive of simple or continuous span.
 - Deflection criteria of L/180 total load and L/240 live load.
- Total load values meet the IBC deflection limit for roof beams for dead load to live load ratios up to 65%. Check local code for other deflection criteria.
- For stiffer deflection criteria, use Live Load L/240 values are provided.
- For continuous spans, ratio of short span to long span should be 0.4 or greater to prevent uplift.
- Lateral support is required at bearing and along the span at 24" on-center, maximum.
- For conditions beyond the scope of this table, including applications other than Service Level 2, use our ForteWEB® and Javelin® software or contact your Weyerhaeuser representative.

DECKS

All lumber framing used in deck applications should be pressure treated to AWPA Standards or recognized in a code evaluation report.

1½" TJ® Rim Board
(with depths ≤ 16")
or 1¼" or 1½"
TimberStrand® LSL

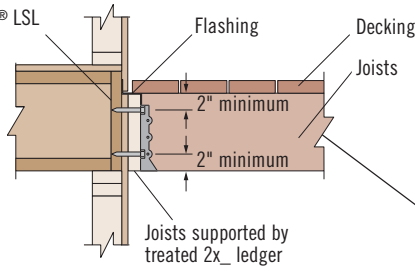

General Notes

- Flashing is a critical component and must be included.
- Lateral restraining connections may be required. Refer to 2021 IRC R507.9.2 and the WUMA deck connection details.

Ledger Connections for 1½" TJ® Rim Board or 1¼" or 1½" TimberStrand LSL Rim Board

Live Load	Joist Span	Connection Type and Spacing ⁽¹⁾	
		Two rows ½" lag bolts	
40 psf	up to 10'	32" on-center, staggered	
	10' to 18'	24" on-center	
60 psf	up to 8'	32" on-center, staggered	
	8' to 14'	24" on-center	
	14' to 18'	16" on-center	

(1) 2" minimum edge distance is required for fastening ledger (see detail above).

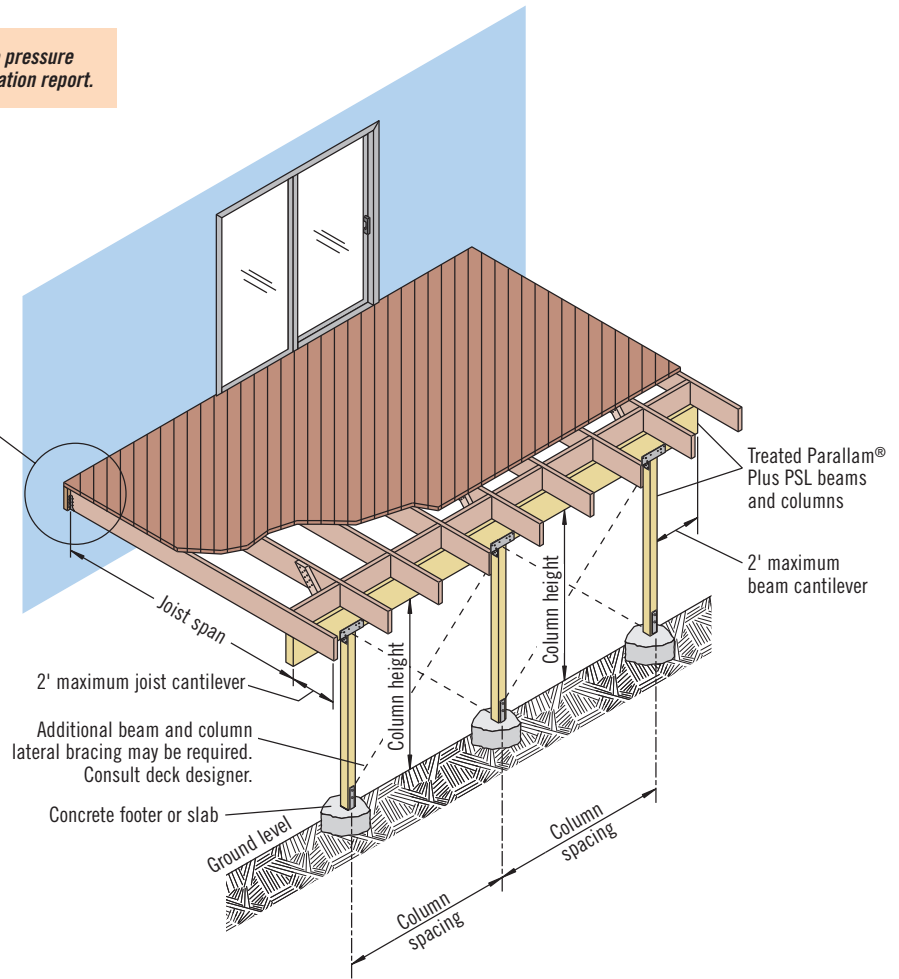

For simple calculators to size Trus Joist Treated Parallam Plus PSL beams and columns for all Design Service Levels and various deck joist spans, please go to weyerhaeuser.com/woodproducts/engineered-lumber/resources/sizing-table-lookup/.

Deck Beam and Column Selection (100% Load Duration)—Service Level 2

Deck Load (psf)	Joist Span	3½" x 9¼" Beam		3½" x 11⅞" Beam		5¼" x 11⅞" Beam		5¼" x 14" Beam	
		3½" x 5¼" Column		3½" x 5¼" Column		5¼" x 5¼" Column		5¼" x 5¼" Column	
		Maximum Column Spacing	Maximum Column Height	Maximum Column Spacing	Maximum Column Height	Maximum Column Spacing	Maximum Column Height	Maximum Column Spacing	Maximum Column Height
40LL + 10DL	8'	11'-6"	11'-6"	11'-6"	11'-6"	16'-6"	17'-0"	16'-6"	16'-6"
	10'	10'-0"	11'-6"	10'-0"	11'-6"	14'-6"	16'-6"	14'-6"	16'-6"
	12'	8'-6"	12'-0"	8'-6"	11'-6"	13'-0"	16'-6"	13'-0"	16'-6"
	14'	8'-0"	11'-6"	8'-0"	11'-6"	11'-6"	17'-0"	11'-6"	16'-6"
60LL + 10DL	8'	8'-0"	12'-0"	8'-0"	11'-6"	12'-0"	17'-0"	12'-0"	16'-6"
	10'	7'-0"	11'-6"	7'-0"	11'-6"	10'-6"	17'-0"	10'-6"	16'-6"
	12'	6'-0"	12'-0"	6'-0"	12'-0"	9'-6"	16'-6"	9'-0"	17'-0"
	14'	5'-6"	12'-0"	5'-6"	11'-6"	8'-6"	16'-6"	8'-6"	16'-6"
	16'	5'-0"	11'-6"	5'-0"	11'-6"	7'-6"	17'-0"	7'-6"	17'-0"

How to Use this Table

- Determine the appropriate **Deck Load**.
- Locate the **Joist Span** that meets or exceeds your condition.
- Scan across the row to find both the **Maximum Column Spacing** and **Maximum Column Height** that meet or exceed your condition.
- Scan up to determine the required **Beam** and **Column** sizes.

General Notes

- Beam and column selections are based on:
 - Uniform gravity loads.
 - More restrictive of simple or continuous span (up to 48').
 - Deflection criteria of L/360 live load and L/240 total load.
 - Minimum bearing length of 5¼" end and/or intermediate.
- For conditions beyond the scope of this table, including beams and columns applications other than Service Level 2, use our ForteWEB® and Javelin® software or contact your Weyerhaeuser representative.

COLUMNS

Allowable Axial Loads (lbs)—Service Level 2

Effective Column Length	Column Size								
	3½" x 5¼"			5¼" x 5¼"			7" x 7"		
	100%	115%	125%	100%	115%	125%	100%	115%	125%
6'	10,885	11,795	12,325	19,660	22,050	23,565	36,965	40,000	40,000
8'	8,080	8,485	8,710	17,155	18,775	19,735	34,575	38,775	40,000
10'	5,940	6,155	6,275	14,220	15,145	15,670	31,375	34,575	36,510
12'	4,495	4,620	4,695	11,470	12,015	12,320	27,630	29,820	31,085
14'	3,500	3,585	3,630	9,275	9,625	9,825	23,750	25,180	25,990
16'	Slenderness ratio exceeds 50			7,600	7,840	7,975	20,215	21,185	21,735
18'				6,320	6,490	6,590	17,235	17,925	18,320
20'				5,325	5,455	5,525	14,795	15,310	15,600

General Notes

- Table is based on:
 - Solid, one-piece column members.
 - Bracing in both directions at column ends.
 - NDS®.
 - Simple columns with axial loads only. For side loads or other combined bending and axial loads, see the NDS®.
- Allowable loads have been adjusted to accommodate the worst case of the following eccentric conditions: ¼ of the column thickness (first dimension) or ¼ of the column width.
- For conditions beyond the scope of this table, including applications other than Service Level 2, use Weyerhaeuser software or contact your Weyerhaeuser representative.

ALLOWABLE HOLES

Treated Parallam® Plus PSL Beam

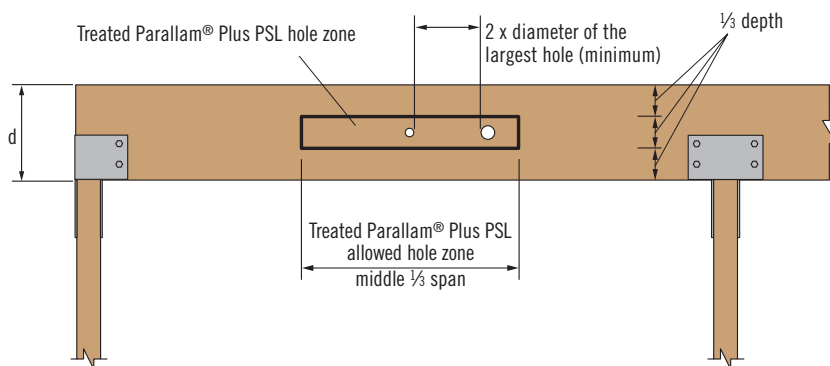

General Notes

- Allowed hole zone suitable for headers and beams with **uniform loads only**.
- Round holes only.
- No holes in cantilevers.
- No holes in headers or beams in plank orientation.

Treated Parallam Plus PSL Beams

Header or Beam Depth	Maximum Round Hole Size
5 ¼" - 7"	1¾"
9 ¼" - 16"	2"

- See illustration for allowed hole zone.

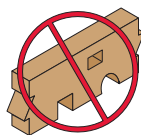

DO NOT cut, notch, or drill holes in Treated Parallam® Plus PSL except as indicated in the illustrations and table above.

Larger holes in Trus Joist® structural composite lumber may be possible; refer to ForteWEB® or Javelin® software.



WARNING: This product can expose you to chemicals including wood dust which are known to the State of California to cause cancer, and methanol, which are known to the State of California to cause birth defects or other reproductive harm. Drilling, sawing, sanding or machining wood products can expose you to wood dust. Avoid inhaling wood dust or use a dust mask or other safeguards for personal protection. For more information go to www.P65Warnings.ca.gov and www.P65Warnings.ca.gov/wood.

COLUMN DETAILS

Beam to Column Connection

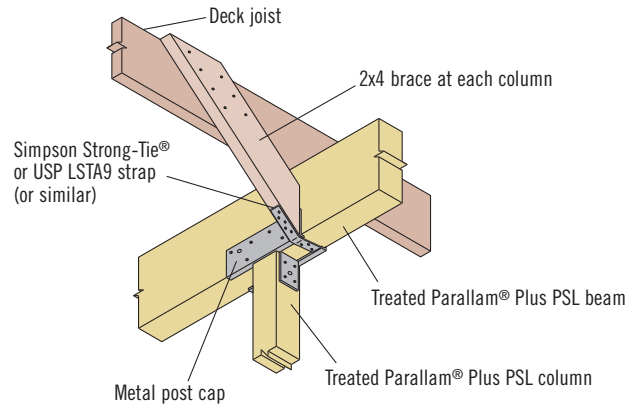

L27

All lumber framing used in deck applications should be pressure treated to AWPA Standards or recognized in a code evaluation report.

Column Base Connections

Column Base

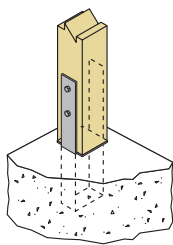

P2

Elevated Column Base

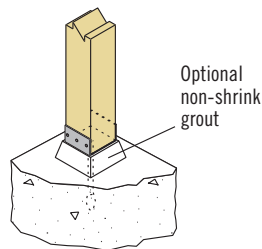

P3

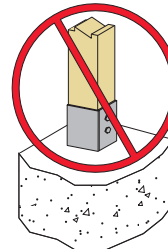

DO NOT encase column base

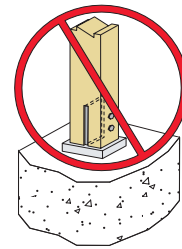

DO NOT size base plate larger than column

Wide face of strands

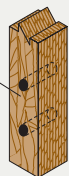

In order to use the manufacturer's published capacities when designing column caps, bases, or holdowns for uplift, the bolts or screws must be installed perpendicular to the wide face of strands as shown at left.

Wide face of strands

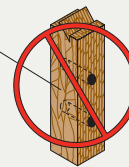

DO NOT install bolts or screws into the narrow face of strands

FLASHING TAPE FOR EXPOSED EXTERIOR DECK BEAMS (RECOMMENDED)

Flashing Tape on Flush Beam

All lumber framing used in deck applications should be pressure treated to AWPA Standards or recognized in a code evaluation report.

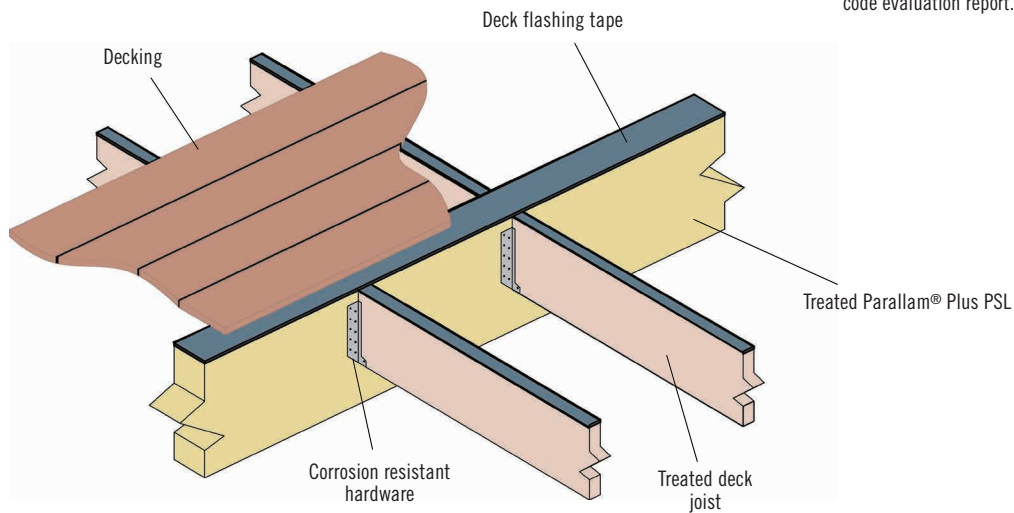

L28

Flashing Tape on Dropped Beam

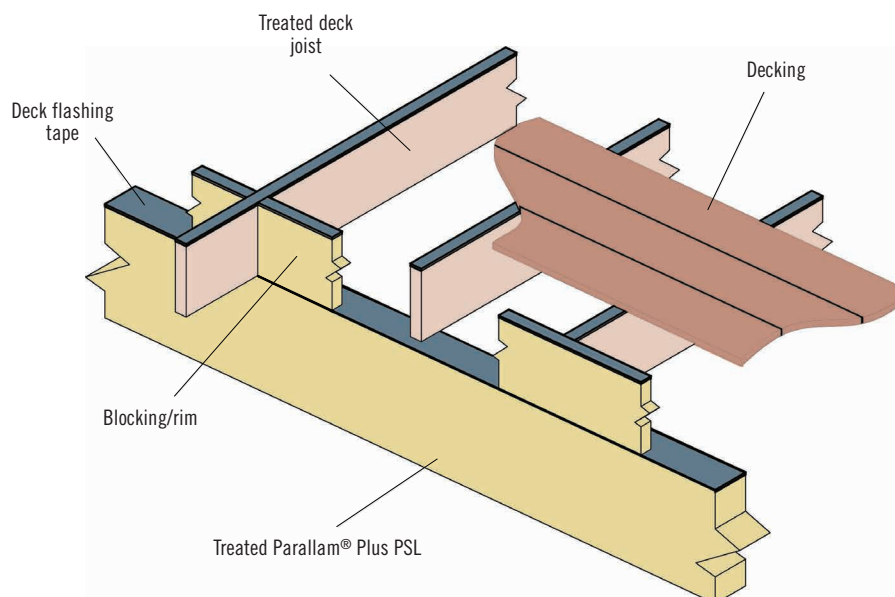

All lumber framing used in deck applications should be pressure treated to AWPA Standards or recognized in a code evaluation report.

L29

CLADDING INFORMATION

Treated Parallam® Plus PSL is suitable for exposed conditions with wet-dry moisture cycles. However it may be desirable for aesthetic reasons to wrap the product in a decorative cladding. As with all treated wood products, avoid applications that can trap moisture. If decorative cladding is used, the following considerations are critical for Treated Parallam® Plus PSL to perform satisfactorily:

- The designer, builder, and owner must share responsibility for ensuring that the assembly is designed, installed, and maintained in a way that will prevent water from entering and being trapped.
- If the prevention of water intrusion over the life of the structure cannot be assured, then cladding must be designed and installed in a manner that allows adequate drainage and sufficient air-flow to facilitate drying. Suggested beam and column details are shown below.
- Water runoff from repeated wetting may transfer residue, such as excess preservative, natural wood extractives, and dirt, which can result in discoloration of architecturally sensitive surrounding construction. Where this is a concern, detailing that limits the potential for repeated water exposure should be used, such as deck tapes along the top horizontal surface.
- Metal cladding materials should not be used, as the preservative treatment can react with the metal and lead to corrosion of the cladding and fasteners.
- All fasteners, furring strips, and other materials used in the cladding assembly must be corrosion-resistant, treated, or otherwise resistant to decay.
- Vented cladding, such as a soffit or drilled cladding material, should be used to allow proper drainage. Routine maintenance is also required to ensure that vent holes remain open and free of debris.
- For column bases with ground contact, maintain a 3" (minimum) gap between cladding and finish grade for drainage. For bases with patio or deck surface contact, maintain a 1" (minimum) gap between cladding and surface.

Cladding on Beams

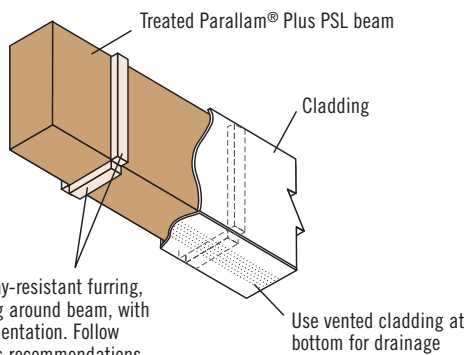

$\frac{3}{8}$ "-thick treated or decay-resistant furring, minimum. Attach furring around beam, with side strips in vertical orientation. Follow cladding manufacturer's recommendations for on-center spacing.

IMPORTANT: Moisture trapped inside the cladding may cause mold. The treatment used in Treated Parallam® Plus does not prevent mold.

Cladding on Columns

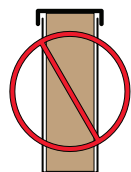
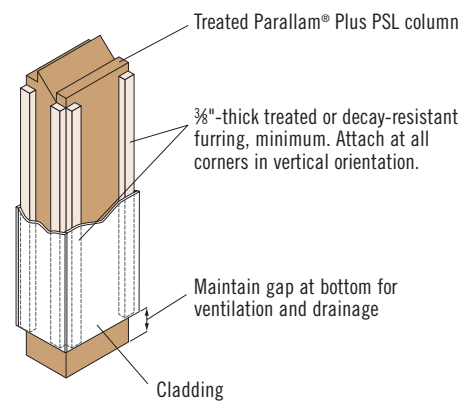

DO NOT wrap exterior Treated Parallam® Plus PSL products with materials that may trap moisture, such as wood, metal, or plastic trim that does not allow for proper ventilation and drainage.

Cladding details shown are intended for use with Treated Parallam® Plus PSL only and should not be used with untreated Weyerhaeuser products.

Q1: What is Treated Parallam® Plus PSL?

A1: Treated Parallam® Plus PSL is Parallam® PSL that has been treated with Koppers Performance Chemicals Inc.'s preservative solutions at a Weyerhaeuser-authorized treating facility. The treating facility is licensed by Koppers to produce treated product and is required to follow a strict quality assurance program.

Treated Parallam® Plus PSL is produced from southern pine and is undersized to accommodate dimensional change during treatment. It is treated then kiln dried after treatment to a uniform moisture content.

Only Treated Parallam® Plus PSL is manufactured using these methods, wood species and it's the only product covered by both Weyerhaeuser (structural) and Koppers (treatment) limited 30-year warranties.

Q2: Is Treated Parallam® Plus PSL recognized by the building code?

A2: Yes. Treated Parallam® Plus PSL meets the provisions of the International Building Code (IBC) for preservative-treated wood. Treated Parallam® Plus PSL is a structural composite lumber product (as defined in IBC chapter 2), which meets the requirements of IBC 2303.1.10 and is preservative-treated in accordance with *American Wood Protection Association (AWPA) Standard U1*, as required by IBC Section 2303.1.9. Third-party quality marks verify that the product was manufactured in accordance with ASTM D5456 (PFS quality mark stamp), as referenced in ICC-ES ESR-1387, and treated in accordance with AWPA Standard U1 for the specified use category (Southern Pine Inspection Bureau, SPIB stamp). Similar requirements and references exist for the International Residential Code (IRC). Design values for Treated Parallam® Plus PSL have been developed considering the effects of treatment and end-use conditions.

Q3: Does Treated Parallam® Plus PSL prevent mold growth on the product surface?

A3: No. Treated Parallam® Plus PSL has been treated to effectively resist fungal decay. The preservative treatment solutions used for Treated Parallam® Plus PSL also contain moldicides that inhibit surface mold growth on freshly treated product; however, they are not intended to provide continual protection from surface mold growth once the product is in service.

Mold fungi cause discoloration of the wood surface, commonly appearing as a colored, fuzzy or powdery surface growth that can quickly spread over surfaces with high moisture levels. Mold will not impact the strength or stiffness of a wood member, but the presence of mold indicates a high moisture condition where, without preservative treatment and proper maintenance, decay or deterioration would likely develop.

Q4: How can I be sure that I have genuine Treated Parallam® Plus PSL?

A4: Treated Parallam® Plus PSL is stamped with the product description, type of treatment, and treating facility. The stamp also references the treating standards and third-party quality program monitor (Southern Pine Inspection Bureau). The following stamps are examples of those found on the face of Treated Parallam® Plus PSL.

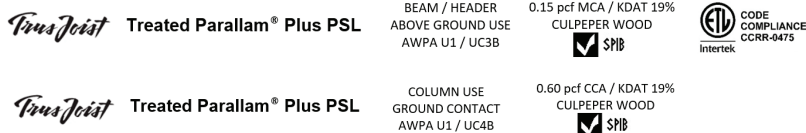

Q5: Does Treated Parallam Plus need to be treated and marked for Use Category UC4A for above ground applications?

A5: The *American Wood Protection Association (AWPA) Book of Standards* groups products into different Commodity Sections. Lumber is in Commodity Section A, which requires lumber in above-ground applications to be treated to the requirements of Use Category UC3B except that lumber members that are difficult to maintain or replace, are required to be treated for the higher chemical retention required for Use Category, UC4A.

Treated Parallam® Plus PSL is a structural composite lumber product covered by Commodity Section F of the *AWPA Book of Standards*. The required chemical retention for Micronized Copper Azole (MCA) used in Treated Parallam® Plus PSL beams is the same for both Use Categories UC3B and UC4A, and thus the lumber requirement explained above does not apply. Therefore, Treated Parallam Plus PSL beam products are labeled UC3B and are not required to be labeled UC4A for above ground applications.

Q6: Was CCA phased out for residential use?

A6: In 2004, CCA was phased out for certain dimension-lumber, residential applications such as deck railings and play sets. However, CCA is an excellent preservative and remains an approved form of treatment for Parallam® PSL columns used in structural ground-contact applications (AWPA UC4B).

Treated Parallam® Plus PSL columns are well suited for residential applications such as structural support columns, deck posts, and retaining walls. It is ideal for applications that result in occasional, intermittent saltwater splash exposure that will not support degradation by marine organisms.

The U.S. EPA concluded that CCA-treated wood does not pose unreasonable risks to the public, and they do not require CCA-treated products to be removed from service, coated/sealed, or encapsulated. However, they do note that the use of a suitable coating could reduce potential exposure.

Additional information is available on the U.S. EPA website at: epa.gov/ingredients-used-pesticide-products/chromated-arsenicals-cca.

Q7: What are wet-service and dry-service conditions?

A7: The definitions of wet and dry service vary slightly from one publication to the next. The NDS® defines dry service for structural composite lumber products as an in-service moisture content of less than 16%. CSA O86 defines dry service as a climatic condition in which the average equilibrium moisture content (EMC) of sawn lumber over a year's time is 15% or less and does not exceed 19%.

Not all exterior applications are necessarily a wet-service condition and, conversely, not all interior applications are a dry-service condition. The EMC of wood is a function of the relative humidity and temperature of the surrounding environment. However, high moisture content and the ensuing degradation can be observed in local areas where water collects and doesn't readily evaporate, such as improperly detailed column bases and connections in saddles where water accumulates.

Q8: How does Weyerhaeuser define “saltwater splash” with respect to applications for Treated Parallam® Plus PSL?

A8: Saltwater splash applications are those in which incidental saltwater contact may occur, but at a level or time period insufficient to support the growth of marine organisms. Examples of incidental saltwater exposure include members used in proximity to saltwater and exposed to occasional or intermittent splash from storms or waves, or to saltwater spray or mist. Examples of conditions that would not be appropriate for Treated Parallam® Plus PSL include members that are in or adjacent to the tidal zone where they would remain wetted with saltwater for extended periods of time.

Q9: What applications are not suitable for Treated Parallam® Plus PSL?

A9: Treated Parallam® Plus PSL is not suited for applications where conditions support degradation by marine organisms, or for direct contact with animal wastes, caustic fertilizers, or other chemicals. These types of applications are not covered by the Weyerhaeuser and Koppers limited 30-year warranties.

Q10: Why does Weyerhaeuser use a different treatment for columns than for beams?

A10: Column applications where Treated Parallam® Plus PSL is exposed to direct ground contact or occasional, intermittent saltwater splash require a higher level of protection, which is best achieved using the traditional CCA preservative.

Treated Parallam® Plus PSL that is intended for beam and header applications is treated with Micronized copper azole at a retention level that eliminates the need to use stainless steel connectors and fasteners in most applications. Refer to hardware manufacturer’s recommendations for your specific application.

At the end of 2023 Weyerhaeuser transitioned from CA-C to MCA treatment. During product transition, CA-C and MCA may be used interchangeably.

Q11: Can I use Treated Parallam® Plus PSL beams in column applications?

A11: Yes, provided it is an above ground application (i.e., not in contact with the ground). Refer to ForteWEB® software for aid in sizing member.

Q12: Can Treated Parallam Plus PSL be embedded into the ground or concrete?

A12: Treated Parallam Plus PSL columns with CCA treatment can be embedded into the ground or concrete in areas defined by AWPA UC4B Ground Contact. For sizing, use Design Service Level 3 in literature and software. Treated Parallam Plus PSL beams with MCA treatment are not approved for embedment into ground or concrete.

Q13: Do I need to field-treat holes or end cuts?

A13: It is not required; however, it is recommended for good construction practice. Recommended endcoat wood preservatives include copper naphthenate (minimum 2% copper recommended, otherwise 1% if not available), oxine copper (minimum 0.675% oxine copper), or Micronized Copper Quat-Type D (2% copper and 1.25% DDAC quat for above ground applications) products. See *American Wood Protection Association Book of Standards, M4*, for additional information.

For the sizes shown in this guide, the unique structure of Treated Parallam® PSL allows for penetration of preservative treatment throughout the cross section, eliminating the need to field treat holes or end cuts.

Q14: Are sealers, coatings, or remedial treatments effective alternatives to Treated Parallam® Plus PSL?

A14: No. Current commercially available coatings that contain a preservative do not provide adequate protection from fungal decay or termites throughout the cross section of Parallam® PSL. Field-applied treatments (other than those recommended for beams with drilled holes and end cuts as described in Q13) are not covered by the Weyerhaeuser and Koppers limited 30-year warranties.

Q15: Do I need to apply deck flashing tape, clad or finish my Treated Parallam® Plus PSL products?

A15: In the case of exposed deck beams, deck flashing tape is recommended on the top edge to enhance moisture protection. Finishing or cladding your Treated Parallam® Plus PSL may be desirable for aesthetic reasons, however, it is not required. In architecturally sensitive applications where Treated Parallam® Plus PSL is subjected to repeated wetting, properly designed flashing and/or cladding is recommended to minimize the potential for water runoff which may discolor surrounding building components. Finishes that trap or seal in moisture should not be used. Cladding must be designed and installed in a way that provides adequate drainage and ventilation to prevent moisture build-up. See details L28 and L29 on page 12.

Q16: Can Treated Parallam® Plus PSL products be painted or stained?

A16: Yes. Treated Parallam® Plus PSL can be painted or stained with either oil- or water-based finishes; we recommend following the manufacturer’s instructions and the label on the finish product. However, before you start, we recommend applying the finish product to a small exposed test area to insure it provides the intended results before proceeding.

Untreated and treated wood products may exhibit discoloration, checking, warping, or splitting when exposed to the weather. Appropriate maintenance, such as the application of quality exterior stains and paints, will help reduce the extent of these weathering effects. However, these finishes may not hide inherent surface irregularities, and the final color may be affected by the tint of the treatment. Commercial paints and finishes that are compatible with preservative-treated products do exist; however, finishes that seal in or trap moisture should not be used.

Q17: Where can I find more information about Treated Parallam® Plus PSL?

A17: For more information on Treated Parallam® Plus PSL, see the Weyerhaeuser *Consumer Safety Information Sheet for Trus Joist® Treated Parallam® Plus PSL* at weyerhaeuser.com/woodproducts/document-library/TJ-1021

Also see the following Safety Data Sheets (SDSs), available on our website:

- **WC S311-13 Parallam® Plus PSL (CCA)**
weyerhaeuser.com/woodproducts/document-library/document_library_detail/parallam-plus-psl-cca-sds/
- **WC S457-06 Parallam® Plus PSL (CA-C and MCA)**
weyerhaeuser.com/application/files/3016/8263/1812/Parallam_Plus_PSL_CA-C_and_MCA_457.pdf

Q18: Where can I purchase Treated Parallam® Plus PSL beams and columns?

A18: Treated Parallam® Plus PSL is intended for use by professional building contractors; therefore, it can be purchased only through professional contractor yards. It is not available for sale through retail channels. For where to buy Treated Parallam® Plus PSL, look up the location on our website: weyerhaeuser.com/woodproducts/where-to-buy/.

WE CAN HELP YOU BUILD SMARTER

You want to build solid and durable structures—we want to help. Weyerhaeuser provides high-quality building products and unparalleled technical and field assistance to support you and your project from start to finish.

Floors and Roofs: Start with the best framing components in the industry: our Trus Joist® TJI® joists; TimberStrand® LSL rim board; and TimberStrand® LSL, Microllam® LVL, and Parallam® PSL headers and beams. Pull them all together with our self-gapping and self-draining Weyerhaeuser Edge Gold™ floor panels and durable Weyerhaeuser roof sheathing.

Walls: Get the best value out of your framing package—use TimberStrand® LSL studs for tall walls, kitchens, and bathrooms, and our traditional, solid-sawn lumber everywhere else. Cut down installation time by using TimberStrand® LSL headers for doors and windows, and Weyerhaeuser wall sheathing with its handy two-way nail lines.

Software Solutions: Whether you are a design professional or lumber dealer, Weyerhaeuser offers an array of software packages to help you specify individual framing members, create cut lists, manage inventories—even help you design a complete structural frame. Contact your Weyerhaeuser representative to find out how to get the software you need.

Technical Support: Need technical help? Weyerhaeuser has one of the largest networks of engineers and sales representatives in the business. Call us for help, and a skilled member from our team of experts will answer your questions and work with you to develop solutions that meet all your structural framing needs.



LIMITED LIFETIME PRODUCT WARRANTY

Weyerhaeuser provides limited lifetime warranties for all Trus Joist® branded products. Product information, installation instructions, and the full text of each product's limited warranty (including limitations and exclusions) are available on the Weyerhaeuser website, from your Weyerhaeuser representative, or by calling toll free: 888-453-8358.

Additionally, Weyerhaeuser offers limited warranties on a broad variety of its other products. To see complete details of all Weyerhaeuser product warranties, visit weyerhaeuser.com/woodproducts/warranty.

1.888.453.8358
[WEYERHAEUSER.COM/WOODPRODUCTS](http://weyerhaeuser.com/woodproducts)

Revised 10/2022 December 2024. Weyerhaeuser and Trus Joist are registered trademarks of Weyerhaeuser. © 2024 Weyerhaeuser NR Company. All rights reserved. California residents: For details on your product's warranty, see instructions for your products, please visit weyerhaeuser.com/woodproducts/warranty.

CONTACT US

1.888.453.8358 • weyerhaeuser.com/woodproducts/contact

Contact your local representative or dealer at:

Visit weyerhaeuser.com/woodproducts/warranty for copies of this and other Trus Joist® Engineered Wood Product warranties.

January 2026 • Reorder TJ-7102

This document supersedes all previous versions. If this is more than one year old, contact your dealer or Weyerhaeuser rep.

Weyerhaeuser, Microllam, Parallam, TimberStrand, TJ, TJI, and Trus Joist are registered trademarks and Edge Gold is a trademark of Weyerhaeuser NR Company. © 2026 Weyerhaeuser NR Company. All rights reserved. Printed in the USA.