

BEAMS, HEADERS, AND COLUMNS

Featuring Trus Joist® TimberStrand® LSL,
Microllam® LVL, and Parallam® PSL



- Uniform and Predictable
- Minimal Bowing, Twisting, and Shrinking
- Strong and Straight
- Limited Product Warranty



Regional guide featuring
2.2E Parallam® PSL and
2.0E Microllam® LVL
headers and beams.



The products in this guide are readily available through our network of distributors and dealers. For more information on other applications or other Trus Joist® products, contact your Weyerhaeuser representative.

TABLE OF CONTENTS

Design Properties	4–5
General Assumptions	5
Floor Load Tables	
TimberStrand® LSL	6–7
Microllam® LVL	8–9
Parallam® PSL	10–11
Snow Roof Load Tables	
TimberStrand® LSL	12–13
Microllam® LVL	14–15
Parallam® PSL	16–17
Non-Snow Roof Load Tables	
TimberStrand® LSL	18–19
Microllam® LVL	20–21
Parallam® PSL	22–23
Beam Details	24
Window and Door Header Details	24–25
Nailing on Narrow Face	25
Allowable Holes	26
Bearing Length Requirements	26
Tapered End Cuts	27
Multiple-Member Connections	28–30
Columns	30–31
Product Warranty	32



Why Choose Trus Joist® Beams, Columns, and Headers?

- Reliable performance
- Consistent quality and dependable uniformity
- Flexible solutions for your beam and header needs
- Backed by a limited product warranty

Using advanced technology, Weyerhaeuser manufactures engineered lumber that is consistently straight and strong, and resists bowing, twisting, and shrinking. That means less waste, easier installation, and higher design values for starters; plus fewer callbacks, shorter cycle times, more design flexibility, and lower overall installed cost in the end. Trus Joist® TimberStrand® LSL, Microllam® LVL, and Parallam® PSL are structural solutions you can count on—guaranteed.

This guide features Trus Joist® engineered lumber in the following widths and depths:

TimberStrand® LSL

1.55E TimberStrand® LSL sizes:

Widths: 1¾" and 3½"

Depths: 9½", 11⅞", 14", and 16"

1.3E TimberStrand® LSL header sizes:

Width: 3½"

Depths: 4⅜", 5½", and 7¼"

1.3E TimberStrand® LSL column and post sizes:

3½" x 3½" 3½" x 4⅜" 3½" x 5½" 3½" x 7¼"

Microllam® LVL

2.0E Microllam® LVL header and beam sizes:

Width: 1¾"

Depths: 5½", 7¼", 9½", 11⅞", 14", 16", and 18"

Parallam® PSL

2.2E Parallam® PSL header and beam sizes:

Widths: 3½", 5¼", and 7"

Depths: 9¼", 9½", 11¼", 11⅞", 14", 16", and 18"

1.8E Parallam® PSL column and post sizes:

3½" x 3½" 3½" x 5¼" 3½" x 7" 5¼" x 5¼" 5¼" x 7" 7" x 7"

For deeper depth Parallam® PSL beams, see the Trus Joist® 2.2E Parallam® PSL Deep Beam Guide, TJ-7001, or contact your Weyerhaeuser representative.

Some sizes may not be available in your region.



WARNING: This product can expose you to chemicals including wood dust which are known to the State of California to cause cancer, and methanol, which are known to the State of California to cause birth defects or other reproductive harm. Drilling, sawing, sanding or machining wood products can expose you to wood dust. Avoid inhaling wood dust or use a dust mask or other safeguards for personal protection. For more information go to www.P65Warnings.ca.gov and www.P65Warnings.ca.gov/wood.

Safety data sheets for all Weyerhaeuser wood products can be found on our website at: weyerhaeuser.com/sustainability/environment/product-stewardship/safety-data-sheets.

STRUCTURAL SOLUTIONS

Trus Joist® TimberStrand® Laminated Strand Lumber (LSL)

- One-piece members reduce labor time
- Every piece is straight and strong
- Unique properties allow you to drill larger holes through 1.55E TimberStrand® LSL. See Allowable Holes on page 26.

TimberStrand® LSL Grade Verification

TimberStrand® LSL is available in more than one grade. The product is stamped with its grade information, as shown in the examples below. With 1.55E TimberStrand® LSL, larger holes can be drilled through the beam.



Trus Joist TimberStrand® LSL 1.3E ICCES ESR-1387 CCMC 12627-R SFI Certified Sourcing SFI-00008 PFS Made in Canada 09-15-11 02 03:20 ■ 0572 ■

Trus Joist TimberStrand® LSL Round Hole Zone See Guidelines 1.55E ICCES ESR-1387 CCMC 12627-R SFI Certified Sourcing SFI-00008 PFS Made in Canada 09-15-11 02 03:20 ■ 0572 ■

Actual stamps shown.

Code Evaluations: See ICC-ES ESR-1387

Trus Joist® Microllam® Laminated Veneer Lumber (LVL)

- Can easily be built up on site to reduce heavy lifting
- Offers reliable and economical solutions for beam and header applications
- Manufacturing process minimizes many of the natural inconsistencies found in wood

Code Evaluations: See ICC-ES ESR-1387



Trus Joist® Parallam® Parallel Strand Lumber (PSL)

- Allows long spans for open floor plans without intermediate posts or columns
- Has warm, unique grain that is perfect for applications with exposed beams
- Provides ideal solutions for cantilever and multi-span applications
- Solid sections save time on site assembly
- Available in some regions with preservative treatment for exterior applications

Parallam® PSL Grade Verification

Parallam® PSL is available in more than one grade. 2.2E Parallam® PSL is stamped with plant identification number 0575.

Code Evaluations: See ICC-ES ESR-1387



DESIGN PROPERTIES

Allowable Design Properties⁽¹⁾ (100% Load Duration)

Grade	Width	Design Property	Depth										
			4¾"	5½"	5½" Plank Orientation	7¼"	9¼"	9½"	11¼"	11⅞"	14"	16"	18"
TimberStrand® LSL													
1.3E	3½"	Moment (ft-lbs)	1,735	2,685	1,780	4,550							
		Shear (lbs)	4,340	5,455	1,925	7,190							
		Moment of Inertia (in. ⁴)	24	49	20	111							
		Weight (plf)	4.5	5.6	5.6	7.4							
1.55E	1¾"	Moment (ft-lbs)						5,210		7,975	10,920	14,090	
		Shear (lbs)						3,435		4,295	5,065	5,785	
		Moment of Inertia (in. ⁴)						125		244	400	597	
		Weight (plf)						5.2		6.5	7.7	8.8	
	3½"	Moment (ft-lbs)						10,420		15,955	21,840	28,180	
		Shear (lbs)						6,870		8,590	10,125	11,575	
		Moment of Inertia (in. ⁴)						250		488	800	1,195	
		Weight (plf)						10.4		13	15.3	17.5	
Microllam® LVL													
2.0E	1¾"	Moment (ft-lbs)		2,125		3,555		5,885		8,925	12,130	15,555	19,375
		Shear (lbs)		1,830		2,410		3,160		3,950	4,655	5,320	5,985
		Moment of Inertia (in. ⁴)		24		56		125		244	400	597	851
		Weight (plf)		2.8		3.7		4.8		6.1	7.1	8.2	9.2
Parallam® PSL													
2.2E	3½"	Moment (ft-lbs)					12,415	13,055	17,970	19,900	27,160	34,955	43,665
		Shear (lbs)					6,260	6,430	7,615	8,035	9,475	10,825	12,180
		Moment of Inertia (in. ⁴)					231	250	415	488	800	1,195	1,701
		Weight (plf)					10.1	10.4	12.3	13.0	15.3	17.5	19.7
	5¼"	Moment (ft-lbs)					18,625	19,585	26,955	29,855	40,740	52,430	65,495
		Shear (lbs)					9,390	9,645	11,420	12,055	14,210	16,240	18,270
		Moment of Inertia (in. ⁴)					346	375	623	733	1,201	1,792	2,552
		Weight (plf)					15.2	15.6	18.5	19.5	23.0	26.3	29.5
	7"	Moment (ft-lbs)					24,830	26,115	35,940	39,805	54,325	69,905	87,325
		Shear (lbs)					12,520	12,855	15,225	16,070	18,945	21,655	24,360
		Moment of Inertia (in. ⁴)					462	500	831	977	1,601	2,389	3,402
		Weight (plf)					20.2	20.8	24.6	26.0	30.6	35.0	39.4

(1) For product in beam orientation, unless otherwise noted.

Some sizes may not be available in your region.

PRODUCT STORAGE



Protect product from sun and water

CAUTION:
Wrap is slippery when wet or icy

Use support blocks (6x6 or larger)
at 10' on-center to keep bundles
out of mud and water

Align stickers (2x3 or larger)
directly over support blocks

DESIGN PROPERTIES

Design Stresses⁽¹⁾ (100% Load Duration)

Grade	Orientation	G Shear Modulus of Elasticity (psi)	E Modulus of Elasticity ⁽²⁾ (psi)	E _{min} Adjusted Modulus of Elasticity ⁽³⁾ (psi)	F _b Flexural Stress ⁽⁴⁾ (psi)	F _t Tension Stress ⁽⁵⁾ (psi)	F _{c⊥} Compression Perpendicular to Grain ⁽⁶⁾ (psi)	F _c Compression Parallel to Grain (psi)	F _v Horizontal Shear Parallel to Grain (psi)	SG Equivalent Specific Gravity ⁽⁷⁾
TimberStrand® LSL										
1.3E	Beam/Column	81,250	1.3 x 10 ⁶	660,750	1,700	1,300	710	1,835	425	0.50 ⁽⁸⁾
	Plank	81,250	1.3 x 10 ⁶	660,750	1,900 ⁽⁹⁾	1,300	670	1,835	150	0.50 ⁽⁸⁾
1.55E	Beam	96,875	1.55 x 10 ⁶	787,815	2,325	1,290 ⁽¹⁰⁾	900	2,170	310 ⁽¹⁰⁾	0.50 ⁽⁸⁾
Microllam® LVL										
2.0E	Beam	125,000	2.0 x 10 ⁶	1,016,535	2,600	1,895	750	2,510	285	0.50
Parallam® PSL										
1.8E	Column	112,500	1.8 x 10 ⁶	914,880	2,400 ⁽¹¹⁾	1,995	545	2,500	190 ⁽¹¹⁾	0.50
2.2E	Beam	137,500	2.2 x 10 ⁶	1,118,190	2,900	2,300	625	2,900 ⁽¹²⁾	290	0.50

(1) Unless otherwise noted, adjustment to the design stresses for duration of load are permitted in accordance with the applicable code.

(2) To properly calculate deflections for the full range of typical SCL span and loading applications, bending and shear deflection must be considered. Use the following equation for simple span, uniformly loaded beams:

$$\Delta = \frac{270 wL^4}{Ebd^3} + \frac{28.8 wL^2}{Ebd}$$

Where: Δ = deflection (in.) w = uniform load (plf)
 L = span (feet) b = beam thickness (in.)
 d = beam depth (in.) E = modulus of elasticity (psi)

For other span and loading conditions, use engineering mechanics to account for both bending and shear deflection or use ForteWEB® software.

(3) Reference modulus of elasticity for beam and column stability calculations, per NDS®.

(4) For 12" depth. For other depths, multiply F_b by the appropriate factor as follows:

$$\text{—TimberStrand® LSL } (12/d)^{0.092} \quad \text{—Microllam® LVL } (12/d)^{0.136} \quad \text{—Parallam® PSL } (12/d)^{0.111}$$

(5) Reference tension design values are based on a standard length of 4 feet. For lengths longer than 4 feet, multiply F_t by the following adjustment (where L is length in feet):

$$\text{—TimberStrand® LSL } (4/L)^{0.083} \quad \text{—Microllam® LVL } (4/L)^{0.085} \quad \text{—Parallam® PSL } (4/L)^{0.056}$$

(6) $F_{c\perp}$ may not be increased for duration of load.

(7) For lateral connection design only.

(8) Specific gravity of 0.58 may be used for bolts installed perpendicular to face and loaded perpendicular to grain.

(9) Values are for thickness up to 3½".

(10) Value accounts for large hole capabilities. See **Allowable Holes** on page 26.

(11) Value shown is for plank orientation.

(12) For column applications, use $F_{c||}$ of 500 psi. Alternatively, refer to ESR-1387, Table 1, footnote 13.

General Assumptions for Trus Joist® Beams

- Lateral support is required at bearing and along the span at 24" on-center, maximum.
- Bearing lengths are based on each product's bearing stress for applicable grade and orientation.
- All members 7¼" and less in depth are restricted to a maximum deflection of 5/16".
- Beams that are 1¾" x 16" and deeper require multiple plies. Some exceptions allowed when using Weyerhaeuser software.
- No camber.
- Beams and columns must remain straight to within 5L/4608 (in.) of true alignment. L is the unrestrained length of the member in feet.

For applications not covered in this brochure, contact your Weyerhaeuser representative.

See pages 28 - 30 for multiple-member beam connections.

Beam Orientation

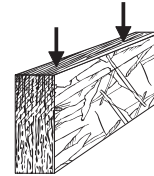

Column Orientation



Plank Orientation

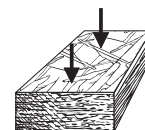

TimberStrand® LSL, Microllam® LVL, and untreated Parallam® PSL are intended for dry-use applications

FLOOR LOAD TABLES

How to Use This Table

1. Calculate total and live load (neglect beam weight) on the beam or header in pounds per linear foot (plf).
2. Select appropriate **Span** (center-to-center of bearing).
3. Scan horizontally to find the proper width, and a depth with a capacity that exceeds actual total and live loads.
4. Review bearing length requirements to ensure adequacy.

Also see **General Notes** on page 7.

TimberStrand® LSL: Floor—100% (PLF)

Span	Condition	1.3E Grade			
		3½" Width			5½" Plank Orientation
		4¾"	5½"	7¼"	3½"
3'	Total Load	1,538	2,381	4,036	1,210
	Live Load L/360	1,420	*	*	*
	Min. End/Int. Bearing (in.)	1.5/3.5	1.5/3.6	2.4/6.1	1.5/3.5
4'	Total Load	863	1,337	2,267	814
	Live Load L/360	651	1,215	*	546
	Min. End/Int. Bearing (in.)	1.5/3.5	1.5/3.5	1.8/4.6	1.5/3.5
5'	Total Load	517	853	1,448	425
	Live Load L/360	347	662	1,398	287
	Min. End/Int. Bearing (in.)	1.5/3.5	1.5/3.5	1.5/3.7	1.5/3.5
6'	Total Load	304	590	1,003	248
	Live Load L/360	206	397	857	169
	Min. End/Int. Bearing (in.)	1.5/3.5	1.5/3.5	1.5/3.5	1.5/3.5
7'	Total Load	171	336	735	138
	Live Load L/360	131	255	560	107
	Min. End/Int. Bearing (in.)	1.5/3.5	1.5/3.5	1.5/3.5	1.5/3.5
8'	Total Load	99	198	443	79
	Live Load L/360	89	173	384	72
	Min. End/Int. Bearing (in.)	1.5/3.5	1.5/3.5	1.5/3.5	1.5/3.5
9'-6"	Total Load		98	224	
	Live Load L/360		*	*	
	Min. End/Int. Bearing (in.)		1.5/3.5	1.5/3.5	
10'	Total Load		79	182	
	Live Load L/360		*	*	
	Min. End/Int. Bearing (in.)		1.5/3.5	1.5/3.5	
12'	Total Load			85	
	Live Load L/360			*	
	Min. End/Int. Bearing (in.)			1.5/3.5	
14'	Total Load				
	Live Load L/360				
	Min. End/Int. Bearing (in.)				
16'-6"	Total Load				
	Live Load L/360				
	Min. End/Int. Bearing (in.)				
18'-6"	Total Load				
	Live Load L/360				
	Min. End/Int. Bearing (in.)				
20'	Total Load				
	Live Load L/360				
	Min. End/Int. Bearing (in.)				
24'	Total Load				
	Live Load L/360				
	Min. End/Int. Bearing (in.)				
28'	Total Load				
	Live Load L/360				
	Min. End/Int. Bearing (in.)				

FLOOR LOAD TABLES

General Notes

- Table is based on:
 - Uniform loads (beam weight considered).
 - More restrictive of simple or continuous span.
 - Deflection criteria of L/240 total load and L/360 live load.
- For live load deflection limits of L/240 or L/480, multiply **Live Load L/360** values by 1.5 or 0.75, respectively. The resulting live load must not exceed the total load shown.
- For continuous spans, ratio of short span to long span should be 0.4 or greater to prevent uplift.

Also see *How to Use this Table* on page 6 and *General Assumptions* on page 5.

TimberStrand® LSL: Floor—100% (PLF) *continued*

Span	Condition	1.55E Grade										
		1½" Width			3½"				5¼" Width (2- or 3-ply)			
		9½"	11⅝"	14"	9½"	11⅝"	14"	16"	9½"	11⅝"	14"	16"
3'	Total Load	3,166	4,717	4,717	6,332	9,432	9,432	9,432	9,499	14,148	14,148	14,148
	Live Load L/360	*	*	*	*	*	*	*	*	*	*	*
	Min. End/Int. Bearing (in.)	3/7.6	4.5/11.3	4.5/11.3	3/7.6	4.5/11.3	4.5/11.3	4.5/11.3	3/7.6	4.5/11.3	4.5/11.3	4.5/11.3
4'	Total Load	2,006	2,836	3,536	4,012	5,673	7,070	7,070	6,018	8,510	10,605	10,605
	Live Load L/360	*	*	*	*	*	*	*	*	*	*	*
	Min. End/Int. Bearing (in.)	2.6/6.4	3.6/9	4.5/11.3	2.6/6.4	3.6/9	4.5/11.3	4.5/11.3	2.6/6.4	3.6/9	4.5/11.3	4.5/11.3
5'	Total Load	1,467	2,004	2,577	2,934	4,009	5,155	5,652	4,401	6,014	7,733	8,478
	Live Load L/360	*	*	*	*	*	*	*	*	*	*	*
	Min. End/Int. Bearing (in.)	2.3/5.8	3.2/8	4.1/10.3	2.3/5.8	3.2/8	4.1/10.3	4.5/11.3	2.3/5.8	3.2/8	4.1/10.3	4.5/11.3
6'	Total Load	1,152	1,549	1,952	2,305	3,098	3,904	4,707	3,458	4,648	5,857	7,061
	Live Load L/360	1,048	*	*	2,097	*	*	*	3,146	*	*	*
	Min. End/Int. Bearing (in.)	2.2/5.5	3/7.4	3.7/9.3	2.2/5.5	3/7.4	3.7/9.3	4.5/11.3	2.2/5.5	3/7.4	3.7/9.3	4.5/11.3
7'	Total Load	845	1,262	1,570	1,691	2,524	3,141	3,787	2,536	3,786	4,711	5,681
	Live Load L/360	699	1,250	*	1,399	2,501	*	*	2,098	3,752	*	*
	Min. End/Int. Bearing (in.)	1.9/4.7	2.8/7	3.5/8.8	1.9/4.7	2.8/7	3.5/8.8	4.2/10.6	1.9/4.7	2.8/7	3.5/8.8	4.2/10.6
8'	Total Load	646	990	1,313	1,292	1,981	2,626	3,138	1,938	2,971	3,939	4,708
	Live Load L/360	487	886	*	974	1,773	*	*	1,462	2,660	*	*
	Min. End/Int. Bearing (in.)	1.7/4.1	2.5/6.3	3.4/8.4	1.7/4.1	2.5/6.3	3.4/8.4	4/10	1.7/4.1	2.5/6.3	3.4/8.4	4/10
9'-6"	Total Load	448	700	960	897	1,401	1,920	2,480	1,346	2,101	2,880	3,720
	Live Load L/360	302	560	870	605	1,121	1,740	2,456	907	1,681	2,610	3,684
	Min. End/Int. Bearing (in.)	1.5/3.5	2.1/5.3	2.9/7.3	1.5/3.5	2.1/5.3	2.9/7.3	3.8/9.4	1.5/3.5	2.1/5.3	2.9/7.3	3.8/9.4
10'	Total Load	387	631	865	775	1,263	1,731	2,236	1,162	1,894	2,597	3,355
	Live Load L/360	261	487	760	523	974	1,520	2,154	785	1,462	2,280	3,232
	Min. End/Int. Bearing (in.)	1.5/3.5	2/5.1	2.8/6.9	1.5/3.5	2/5.1	2.8/6.9	3.6/8.9	1.5/3.5	2/5.1	2.8/6.9	3.6/8.9
12'	Total Load	228	434	599	456	868	1,198	1,547	685	1,302	1,797	2,321
	Live Load L/360	155	293	464	311	587	928	1,334	467	881	1,393	2,001
	Min. End/Int. Bearing (in.)	1.5/3.5	1.7/4.2	2.3/5.8	1.5/3.5	1.7/4.2	2.3/5.8	3/7.5	1.5/3.5	1.7/4.2	2.3/5.8	3/7.5
14'	Total Load	144	278	438	288	556	876	1,132	433	834	1,314	1,698
	Live Load L/360	99	189	302	199	379	605	877	299	569	907	1,316
	Min. End/Int. Bearing (in.)	1.5/3.5	1.5/3.5	2/5	1.5/3.5	1.5/3.5	2/5	2.6/6.4	1.5/3.5	1.5/3.5	2/5	2.6/6.4
16'-6"	Total Load	87	170	277	174	341	554	810	262	512	831	1,215
	Live Load L/360	61	118	189	123	236	379	555	185	354	569	832
	Min. End/Int. Bearing (in.)	1.5/3.5	1.5/3.5	1.5/3.7	1.5/3.5	1.5/3.5	1.5/3.7	2.2/5.4	1.5/3.5	1.5/3.5	1.5/3.7	2.2/5.4
18'-6"	Total Load	60	120	197	121	241	395	584	182	362	592	876
	Live Load L/360	44	84	136	88	169	273	401	132	254	410	601
	Min. End/Int. Bearing (in.)	1.5/3.5	1.5/3.5	1.5/3.5	1.5/3.5	1.5/3.5	1.5/3.5	1.8/4.4	1.5/3.5	1.5/3.5	1.5/3.5	1.8/4.4
20'	Total Load		94	156	94	189	312	463	142	284	468	695
	Live Load L/360		67	109	70	135	218	320	105	202	327	481
	Min. End/Int. Bearing (in.)		1.5/3.5	1.5/3.5	1.5/3.5	1.5/3.5	1.5/3.5	1.5/3.8	1.5/3.5	1.5/3.5	1.5/3.5	1.5/3.8
24'	Total Load		52	88		105	177	266	76	158	265	400
	Live Load L/360		39	64		79	128	189	61	118	192	284
	Min. End/Int. Bearing (in.)		1.5/3.5	1.5/3.5		1.5/3.5	1.5/3.5	1.5/3.5	1.5/3.5	1.5/3.5	1.5/3.5	1.5/3.5
28'	Total Load			53		62	107	163		93	160	245
	Live Load L/360			40		50	81	120		75	122	181
	Min. End/Int. Bearing (in.)			1.5/3.5		1.5/3.5	1.5/3.5	1.5/3.5		1.5/3.5	1.5/3.5	1.5/3.5

* Indicates Total Load value controls.

FLOOR LOAD TABLES

How to Use This Table

1. Calculate total and live load (neglect beam weight) on the beam or header in pounds per linear foot (plf).
2. Select appropriate **Span** (center-to-center of bearing).
3. Scan horizontally to find the proper width, and a depth with a capacity that exceeds actual total and live loads.
4. Review bearing length requirements to ensure adequacy.

Also see **General Notes** on page 9.

2.OE Microllam® LVL: Floor—100% (PLF)

Span	Condition	1¾" Width					3½" Width (2-ply)			
		5½"	7¼"	9½"	11⅞"	14"	5½"	7¼"	9½"	11⅞"
6'	Total Load	455	762	1,062	1,424	1,794	910	1,525	2,125	2,848
	Live Load L/360	305	659	*	*	*	610	1,319	*	*
	Min. End/Int. Bearing (in.)	1.5/3.5	1.8/4.4	2.4/6.1	3.3/8.2	4.1/10.3	1.5/3.5	1.8/4.4	2.4/6.1	3.3/8.2
8'	Total Load	153	342	731	978	1,207	307	685	1,462	1,956
	Live Load L/360	133	295	628	*	*	267	591	1,257	*
	Min. End/Int. Bearing (in.)	1.5/3.5	1.5/3.5	2.2/5.6	3/7.5	3.7/9.3	1.5/3.5	1.5/3.5	2.2/5.6	3/7.5
9'-6"	Total Load	77	174	517	784	968	154	349	1,034	1,569
	Live Load L/360	*	*	390	723	*	*	*	780	1,446
	Min. End/Int. Bearing (in.)	1.5/3.5	1.5/3.5	1.9/4.7	2.9/7.2	3.5/8.8	1.5/3.5	1.5/3.5	1.9/4.7	2.9/7.2
10'	Total Load	62	142	466	707	908	124	284	932	1,415
	Live Load L/360	*	*	337	628	*	*	*	675	1,257
	Min. End/Int. Bearing (in.)	1.5/3.5	1.5/3.5	1.8/4.5	2.7/6.8	3.5/8.7	1.5/3.5	1.5/3.5	1.8/4.5	2.7/6.8
12'	Total Load		67	296	489	666	57	135	593	979
	Live Load L/360		*	200	379	599	*	*	401	758
	Min. End/Int. Bearing (in.)		1.5/3.5	1.5/3.5	2.3/5.7	3.1/7.7	1.5/3.5	1.5/3.5	1.5/3.5	2.3/5.7
14'	Total Load			188	358	487		70	376	716
	Live Load L/360			128	244	390		*	257	489
	Min. End/Int. Bearing (in.)			1.5/3.5	1.9/4.9	2.6/6.6		1.5/3.5	1.5/3.5	1.9/4.9
16'-6"	Total Load			114	222	349			229	445
	Live Load L/360			79	152	245			159	305
	Min. End/Int. Bearing (in.)			1.5/3.5	1.5/3.6	2.2/5.6			1.5/3.5	1.5/3.6
18'-6"	Total Load			80	158	257			161	316
	Live Load L/360			56	109	176			113	218
	Min. End/Int. Bearing (in.)			1.5/3.5	1.5/3.5	1.9/4.7			1.5/3.5	1.5/3.5
20'	Total Load			62	124	204			125	249
	Live Load L/360			45	87	140			90	174
	Min. End/Int. Bearing (in.)			1.5/3.5	1.5/3.5	1.6/4			1.5/3.5	1.5/3.5
22'	Total Load				92	152			92	185
	Live Load L/360				65	106			68	131
	Min. End/Int. Bearing (in.)				1.5/3.5	1.5/3.5			1.5/3.5	1.5/3.5
24'	Total Load				70	117			69	140
	Live Load L/360				51	82			52	102
	Min. End/Int. Bearing (in.)				1.5/3.5	1.5/3.5			1.5/3.5	1.5/3.5
26'	Total Load				54	91			52	108
	Live Load L/360				40	65			41	80
	Min. End/Int. Bearing (in.)				1.5/3.5	1.5/3.5			1.5/3.5	1.5/3.5
28'	Total Load					71				84
	Live Load L/360					52				64
	Min. End/Int. Bearing (in.)					1.5/3.5				1.5/3.5
30'	Total Load					57				66
	Live Load L/360					42				52
	Min. End/Int. Bearing (in.)					1.5/3.5				1.5/3.5

* Indicates **Total Load** value controls.

FLOOR LOAD TABLES

General Notes

- Table is based on:
 - Uniform loads (beam weight considered).
 - More restrictive of simple or continuous span.
 - Deflection criteria of L/240 total load and L/360 live load.
- For live load deflection limits of L/240 or L/480, multiply **Live Load L/360** values by 1.5 or 0.75, respectively. The resulting live load must not exceed the total load shown.
- For continuous spans, ratio of short span to long span should be 0.4 or greater to prevent uplift.

Also see *How to Use This Table* on page 8 and *General Assumptions* on page 5.

2.OE Microllam® LVL: Floor—100% (PLF) *continued*

Span	Condition	3½" Width (2-ply)			5¼" Width (3-ply)						
		14"	16"	18"	5½"	7¼"	9½"	11½"	14"	16"	18"
6'	Total Load	3,589	3,919	3,919	1,366	2,287	3,188	4,272	5,384	5,878	5,878
	Live Load L/360	*	*	*	916	1,978	*	*	*	*	*
	Min. End/Int. Bearing (in.)	4.1/10.3	4.5/11.3	4.5/11.3	1.5/3.5	1.8/4.4	2.4/6.1	3.3/8.2	4.1/10.3	4.5/11.3	4.5/11.3
8'	Total Load	2,414	2,885	2,934	461	1,028	2,193	2,935	3,621	4,328	4,402
	Live Load L/360	*	*	*	401	887	1,886	*	*	*	*
	Min. End/Int. Bearing (in.)	3.7/9.3	4.4/11.1	4.5/11.3	1.5/3.5	1.5/3.5	2.2/5.6	3/7.5	3.7/9.3	4.4/11.1	4.5/11.3
9'-6"	Total Load	1,937	2,294	2,468	231	524	1,551	2,354	2,905	3,441	3,702
	Live Load L/360	*	*	*	*	*	1,171	2,170	*	*	*
	Min. End/Int. Bearing (in.)	3.5/8.8	4.2/10.5	4.5/11.3	1.5/3.5	1.5/3.5	1.9/4.7	2.9/7.2	3.5/8.8	4.2/10.5	4.5/11.3
10'	Total Load	1,817	2,147	2,344	187	427	1,398	2,123	2,725	3,221	3,516
	Live Load L/360	*	*	*	*	*	1,013	1,886	*	*	*
	Min. End/Int. Bearing (in.)	3.5/8.7	4.1/10.3	4.5/11.3	1.5/3.5	1.5/3.5	1.8/4.5	2.7/6.8	3.5/8.7	4.1/10.3	4.5/11.3
12'	Total Load	1,333	1,709	1,950	86	203	889	1,469	2,000	2,563	2,925
	Live Load L/360	1,198	*	*	*	*	602	1,137	1,797	*	*
	Min. End/Int. Bearing (in.)	3.1/7.7	3.9/9.9	4.5/11.3	1.5/3.5	1.5/3.5	1.5/3.5	2.3/5.7	3.1/7.7	3.9/9.9	4.5/11.3
14'	Total Load	975	1,253	1,563		106	564	1,074	1,463	1,880	2,345
	Live Load L/360	780	1,132	1,561		*	386	734	1,171	1,698	2,342
	Min. End/Int. Bearing (in.)	2.6/6.6	3.4/8.5	4.2/10.5		1.5/3.5	1.5/3.5	1.9/4.9	2.6/6.6	3.4/8.5	4.2/10.5
16'-6"	Total Load	698	897	1,120			343	668	1,047	1,346	1,680
	Live Load L/360	490	716	995			238	457	735	1,074	1,493
	Min. End/Int. Bearing (in.)	2.2/5.6	2.9/7.2	3.6/8.9			1.5/3.5	1.5/3.6	2.2/5.6	2.9/7.2	3.6/8.9
18'-6"	Total Load	515	710	887			241	474	772	1,066	1,331
	Live Load L/360	352	517	722			170	328	529	776	1,084
	Min. End/Int. Bearing (in.)	1.9/4.7	2.6/6.4	3.2/8			1.5/3.5	1.5/3.5	1.9/4.7	2.6/6.4	3.2/8
20'	Total Load	408	604	756			188	374	612	907	1,135
	Live Load L/360	281	414	579			135	261	422	621	869
	Min. End/Int. Bearing (in.)	1.6/4	2.4/5.9	3/7.4			1.5/3.5	1.5/3.5	1.6/4	2.4/5.9	3/7.4
22'	Total Load	305	455	622			138	278	458	683	933
	Live Load L/360	213	314	441			102	197	320	472	662
	Min. End/Int. Bearing (in.)	1.5/3.5	2/4.9	2.7/6.7			1.5/3.5	1.5/3.5	1.5/3.5	2/4.9	2.7/6.7
24'	Total Load	234	350	497			104	211	351	525	746
	Live Load L/360	165	244	343			79	153	248	366	515
	Min. End/Int. Bearing (in.)	1.5/3.5	1.7/4.2	2.4/5.9			1.5/3.5	1.5/3.5	1.5/3.5	1.7/4.2	2.4/5.9
26'	Total Load	182	274	390			78	163	273	411	586
	Live Load L/360	130	193	272			62	120	196	290	409
	Min. End/Int. Bearing (in.)	1.5/3.5	1.5/3.6	2/5.1			1.5/3.5	1.5/3.5	1.5/3.5	1.5/3.6	2/5.1
28'	Total Load	143	217	311			60	127	215	326	467
	Live Load L/360	105	155	219			50	97	157	233	329
	Min. End/Int. Bearing (in.)	1.5/3.5	1.5/3.5	1.8/4.4			1.5/3.5	1.5/3.5	1.5/3.5	1.5/3.5	1.8/4.4
30'	Total Load	114	174	251				100	171	261	376
	Live Load L/360	85	127	179				79	128	190	269
	Min. End/Int. Bearing (in.)	1.5/3.5	1.5/3.5	1.5/3.9				1.5/3.5	1.5/3.5	1.5/3.5	1.5/3.9

* Indicates Total Load value controls.

FLOOR LOAD TABLES

How to Use This Table

1. Calculate total and live load (neglect beam weight) on the beam or header in pounds per linear foot (plf).
2. Select appropriate **Span** (center-to-center of bearing).
3. Scan horizontally to find the proper width, and a depth with a capacity that exceeds actual total and live loads.
4. Review bearing length requirements to ensure adequacy.

Also see **General Notes** on page 11.

2.2E Parallam® PSL: Floor—100% (PLF)

Span	Condition	3½" Width							5¼" Width						
		9¼"	9½"	11¼"	11⅞"	14"	16"	18"	9¼"	9½"	11¼"	11⅞"	14"	16"	18"
8'	Total Load	1,469	1,517	1,861	1,990	2,441	2,441	2,441	2,204	2,275	2,792	2,985	3,661	3,661	3,661
	Live Load L/360	1,286	1,383	*	*	*	*	*	1,929	2,075	*	*	*	*	*
	Min. End/Int. Bearing (in.)	2.7/6.8	2.8/7	3.4/8.6	3.7/9.2	4.5/11.3	4.5/11.3	4.5/11.3	2.7/6.8	2.8/7	3.4/8.6	3.7/9.2	4.5/11.3	4.5/11.3	4.5/11.3
9'-6"	Total Load	1,090	1,147	1,510	1,611	1,970	2,052	2,052	1,635	1,720	2,265	2,416	2,955	3,079	3,079
	Live Load L/360	796	858	1,373	1,591	*	*	*	1,195	1,288	2,059	2,387	*	*	*
	Min. End/Int. Bearing (in.)	2.4/6	2.5/6.3	3.3/8.3	3.5/8.8	4.3/10.8	4.5/11.3	4.5/11.3	2.4/6	2.5/6.3	3.3/8.3	3.5/8.8	4.3/10.8	4.5/11.3	4.5/11.3
10'	Total Load	983	1,034	1,420	1,514	1,848	1,949	1,949	1,474	1,551	2,130	2,271	2,772	2,923	2,923
	Live Load L/360	689	743	1,192	1,383	*	*	*	1,034	1,115	1,788	2,075	*	*	*
	Min. End/Int. Bearing (in.)	2.3/5.7	2.4/6	3.3/8.2	3.5/8.7	4.3/10.6	4.5/11.3	4.5/11.3	2.3/5.7	2.4/6	3.3/8.2	3.5/8.7	4.3/10.6	4.5/11.3	4.5/11.3
12'	Total Load	604	652	986	1,092	1,480	1,620	1,620	906	979	1,479	1,639	2,220	2,431	2,431
	Live Load L/360	409	442	716	834	1,318	*	*	614	663	1,074	1,251	1,977	*	*
	Min. End/Int. Bearing (in.)	1.7/4.2	1.8/4.5	2.7/6.8	3/7.6	4.1/10.3	4.5/11.3	4.5/11.3	1.7/4.2	1.8/4.5	2.7/6.8	3/7.6	4.1/10.3	4.5/11.3	4.5/11.3
14'	Total Load	382	414	679	795	1,093	1,386	1,386	574	621	1,019	1,192	1,639	2,079	2,079
	Live Load L/360	261	283	461	538	858	1,245	*	392	424	692	808	1,288	1,868	*
	Min. End/Int. Bearing (in.)	1.5/3.5	1.5/3.5	2.2/5.5	2.6/6.5	3.5/8.9	4.5/11.3	4.5/11.3	1.5/3.5	1.5/3.5	2.2/5.5	2.6/6.5	3.5/8.9	4.5/11.3	4.5/11.3
16'-6"	Total Load	232	252	418	490	782	1,009	1,173	349	378	627	736	1,174	1,514	1,760
	Live Load L/360	162	175	287	335	539	787	1,095	243	262	430	503	808	1,181	1,642
	Min. End/Int. Bearing (in.)	1.5/3.5	1.5/3.5	1.6/4.1	1.9/4.7	3/7.5	3.9/9.7	4.5/11.3	1.5/3.5	1.5/3.5	1.6/4.1	1.9/4.7	3/7.5	3.9/9.7	4.5/11.3
18'-6"	Total Load	163	177	296	348	567	799	1,000	245	266	444	522	850	1,199	1,501
	Live Load L/360	115	125	205	240	388	569	795	173	187	308	361	582	854	1,192
	Min. End/Int. Bearing (in.)	1.5/3.5	1.5/3.5	1.5/3.5	1.5/3.8	2.5/6.2	3.5/8.6	4.3/10.8	1.5/3.5	1.5/3.5	1.5/3.5	1.5/3.8	2.5/6.2	3.5/8.6	4.3/10.8
20'	Total Load	127	138	233	274	449	665	853	191	208	349	412	674	998	1,280
	Live Load L/360	91	99	163	191	309	455	637	137	149	245	287	464	683	956
	Min. End/Int. Bearing (in.)	1.5/3.5	1.5/3.5	1.5/3.5	1.5/3.5	2.1/5.3	3.1/7.8	4/10	1.5/3.5	1.5/3.5	1.5/3.5	1.5/3.5	2.1/5.3	3.1/7.8	4/10
22'	Total Load	93	102	173	204	336	501	702	140	153	259	306	505	752	1,053
	Live Load L/360	69	75	123	144	234	346	485	104	112	185	217	352	519	728
	Min. End/Int. Bearing (in.)	1.5/3.5	1.5/3.5	1.5/3.5	1.5/3.5	1.8/4.4	2.6/6.5	3.6/9.1	1.5/3.5	1.5/3.5	1.5/3.5	1.5/3.5	1.8/4.4	2.6/6.5	3.6/9.1
24'	Total Load	70	76	131	155	257	385	547	105	114	196	233	386	578	821
	Live Load L/360	53	57	95	112	182	268	378	80	86	143	168	273	403	567
	Min. End/Int. Bearing (in.)	1.5/3.5	1.5/3.5	1.5/3.5	1.5/3.5	1.5/3.7	2.2/5.5	3.1/7.8	1.5/3.5	1.5/3.5	1.5/3.5	1.5/3.5	1.5/3.7	2.2/5.5	3.1/7.8
26'	Total Load	53	58	100	119	200	301	430	79	87	151	179	300	452	645
	Live Load L/360	42	45	75	88	143	212	300	63	68	113	132	215	319	450
	Min. End/Int. Bearing (in.)	1.5/3.5	1.5/3.5	1.5/3.5	1.5/3.5	1.5/3.5	1.9/4.7	2.7/6.7	1.5/3.5	1.5/3.5	1.5/3.5	1.5/3.5	1.5/3.5	1.9/4.7	2.7/6.7
28'	Total Load			78	93	158	239	343	61	66	117	140	237	359	514
	Live Load L/360			60	71	115	171	241	50	55	90	106	173	257	362
	Min. End/Int. Bearing (in.)			1.5/3.5	1.5/3.5	1.5/3.5	1.6/4.1	2.3/5.8	1.5/3.5	1.5/3.5	1.5/3.5	1.5/3.5	1.5/3.5	1.6/4.1	2.3/5.8
30'	Total Load			61	73	126	192	276		51	92	110	189	288	415
	Live Load L/360			49	57	94	139	197		44	74	86	141	209	296
	Min. End/Int. Bearing (in.)			1.5/3.5	1.5/3.5	1.5/3.5	1.5/3.6	2/5.1		1.5/3.5	1.5/3.5	1.5/3.5	1.5/3.5	1.5/3.6	2/5.1
32'	Total Load			58	101	156	225				73	88	152	234	338
	Live Load L/360			47	78	115	163				61	71	117	173	245
	Min. End/Int. Bearing (in.)			1.5/3.5	1.5/3.5	1.5/3.5	1.8/4.5				1.5/3.5	1.5/3.5	1.5/3.5	1.5/3.5	1.8/4.5

* Indicates Total Load value controls.

FLOOR LOAD TABLES

General Notes

- Table is based on:
 - Uniform loads (beam weight considered).
 - More restrictive of simple or continuous span.
 - Deflection criteria of L/240 total load and L/360 live load.
- For live load deflection limits of L/240 or L/480, multiply **Live Load L/360** values by 1.5 or 0.75, respectively. The resulting live load must not exceed the total load shown.
- For continuous spans, ratio of short span to long span should be 0.4 or greater to prevent uplift.

Also see *How to Use This Table* on page 10 and *General Assumptions* on page 5.

2.2E Parallam® PSL: Floor—100% (PLF) *continued*

Span	Condition	7" Width						
		9¼"	9½"	11¼"	11⅞"	14"	16"	18"
8'	Total Load	2,939	3,034	3,723	3,981	4,882	4,882	4,882
	Live Load L/360	2,572	2,767	*	*	*	*	*
	Min. End/Int. Bearing (in.)	2.7/6.8	2.8/7	3.4/8.6	3.7/9.2	4.5/11.3	4.5/11.3	4.5/11.3
9'-6"	Total Load	2,180	2,294	3,020	3,222	3,940	4,105	4,105
	Live Load L/360	1,593	1,717	2,746	3,182	*	*	*
	Min. End/Int. Bearing (in.)	2.4/6	2.5/6.3	3.3/8.3	3.5/8.8	4.3/10.8	4.5/11.3	4.5/11.3
10'	Total Load	1,966	2,068	2,841	3,029	3,696	3,898	3,898
	Live Load L/360	1,378	1,486	2,385	2,767	*	*	*
	Min. End/Int. Bearing (in.)	2.3/5.7	2.4/6	3.3/8.2	3.5/8.7	4.3/10.6	4.5/11.3	4.5/11.3
12'	Total Load	1,208	1,305	1,972	2,185	2,960	3,241	3,241
	Live Load L/360	818	884	1,432	1,668	2,636	*	*
	Min. End/Int. Bearing (in.)	1.7/4.2	1.8/4.5	2.7/6.8	3/7.6	4.1/10.3	4.5/11.3	4.5/11.3
14'	Total Load	765	828	1,359	1,590	2,186	2,773	2,773
	Live Load L/360	523	566	922	1,077	1,717	2,490	*
	Min. End/Int. Bearing (in.)	1.5/3.5	1.5/3.5	2.2/5.5	2.6/6.5	3.5/8.9	4.5/11.3	4.5/11.3
16'-6"	Total Load	465	504	836	981	1,565	2,019	2,346
	Live Load L/360	324	350	574	671	1,078	1,575	2,190
	Min. End/Int. Bearing (in.)	1.5/3.5	1.5/3.5	1.6/4.1	1.9/4.7	3/7.5	3.9/9.7	4.5/11.3
18'-6"	Total Load	326	354	592	696	1,134	1,599	2,001
	Live Load L/360	231	250	411	481	776	1,139	1,590
	Min. End/Int. Bearing (in.)	1.5/3.5	1.5/3.5	1.5/3.5	1.5/3.8	2.5/6.2	3.5/8.6	4.3/10.8
20'	Total Load	255	277	466	549	898	1,331	1,707
	Live Load L/360	183	198	327	383	619	911	1,275
	Min. End/Int. Bearing (in.)	1.5/3.5	1.5/3.5	1.5/3.5	1.5/3.5	2.1/5.3	3.1/7.8	4/10
22'	Total Load	187	204	346	409	673	1,003	1,404
	Live Load L/360	138	150	247	289	469	692	971
	Min. End/Int. Bearing (in.)	1.5/3.5	1.5/3.5	1.5/3.5	1.5/3.5	1.8/4.4	2.6/6.5	3.6/9.1
24'	Total Load	140	153	262	310	515	771	1,095
	Live Load L/360	107	115	191	224	364	537	756
	Min. End/Int. Bearing (in.)	1.5/3.5	1.5/3.5	1.5/3.5	1.5/3.5	1.5/3.7	2.2/5.5	3.1/7.8
26'	Total Load	106	116	201	239	401	603	860
	Live Load L/360	84	91	151	177	287	425	600
	Min. End/Int. Bearing (in.)	1.5/3.5	1.5/3.5	1.5/3.5	1.5/3.5	1.5/3.5	1.9/4.7	2.7/6.7
28'	Total Load	81	89	157	187	316	479	686
	Live Load L/360	67	73	121	142	231	342	483
	Min. End/Int. Bearing (in.)	1.5/3.5	1.5/3.5	1.5/3.5	1.5/3.5	1.5/3.5	1.6/4.1	2.3/5.8
30'	Total Load	62	68	123	147	252	384	553
	Live Load L/360	55	59	98	115	188	279	395
	Min. End/Int. Bearing (in.)	1.5/3.5	1.5/3.5	1.5/3.5	1.5/3.5	1.5/3.5	1.5/3.6	2/5.1
32'	Total Load		53	97	117	203	312	451
	Live Load L/360		49	81	95	156	231	327
	Min. End/Int. Bearing (in.)		1.5/3.5	1.5/3.5	1.5/3.5	1.5/3.5	1.5/3.5	1.8/4.5

h) Indicates Total Load value controls.

SNOW ROOF LOAD TABLES

How to Use This Table

1. Calculate total load (neglect beam weight) on the beam or header in pounds per linear foot (plf).
2. Select appropriate **Span** (center-to-center of bearing).
3. Scan horizontally to find the proper width, and a depth with a capacity that exceeds actual total load.
4. Review bearing length requirements to ensure adequacy.

Also see **General Notes** on page 13.

TimberStrand® LSL: Roof—Snow Load Area 115% (PLF)

Span	Condition	1.3E Grade			
		3½" Width			5½" Plank Orientation
		4¾"	5½"	7¼"	3½"
3'	Total Load	1,769	2,739	4,643	1,392
	Deflection L/240 / L/360	*/1,420	*/2,547	*/*	*/1,224
	Min. End/Int. Bearing (in.)	1.5/3.5	1.7/4.1	2.8/7	1.5/3.5
4'	Total Load	993	1,538	2,608	996
	Deflection L/240 / L/360	977/651	*/1,215	*/2,476	820/546
	Min. End/Int. Bearing (in.)	1.5/3.5	1.5/3.5	2.1/5.3	1.5/3.5
5'	Total Load	634	982	1,666	533
	Deflection L/240 / L/360	521/347	*/662	*/1,398	431/287
	Min. End/Int. Bearing (in.)	1.5/3.5	1.5/3.5	1.7/4.2	1.5/3.5
6'	Total Load	317	614	1,155	258
	Deflection L/240 / L/360	309/206	595/397	*/857	253/169
	Min. End/Int. Bearing (in.)	1.5/3.5	1.5/3.5	1.5/3.5	1.5/3.5
7'	Total Load	171	336	742	138
	Deflection L/240 / L/360	*/131	*/255	*/560	*/107
	Min. End/Int. Bearing (in.)	1.5/3.5	1.5/3.5	1.5/3.5	1.5/3.5
8'	Total Load	99	198	443	79
	Deflection L/240 / L/360	*/89	*/173	*/384	*/72
	Min. End/Int. Bearing (in.)	1.5/3.5	1.5/3.5	1.5/3.5	1.5/3.5
9'-6"	Total Load		98	224	
	Deflection L/240 / L/360		*/*	*/*	
	Min. End/Int. Bearing (in.)		1.5/3.5	1.5/3.5	
10'	Total Load		79	182	
	Deflection L/240 / L/360		*/*	*/*	
	Min. End/Int. Bearing (in.)		1.5/3.5	1.5/3.5	
12'	Total Load			85	
	Deflection L/240 / L/360			*/*	
	Min. End/Int. Bearing (in.)			1.5/3.5	
14'	Total Load				
	Deflection L/240 / L/360				
	Min. End/Int. Bearing (in.)				
16'-6"	Total Load				
	Deflection L/240 / L/360				
	Min. End/Int. Bearing (in.)				
18'-6"	Total Load				
	Deflection L/240 / L/360				
	Min. End/Int. Bearing (in.)				
20'	Total Load				
	Deflection L/240 / L/360				
	Min. End/Int. Bearing (in.)				
24'	Total Load				
	Deflection L/240 / L/360				
	Min. End/Int. Bearing (in.)				
28'	Total Load				
	Deflection L/240 / L/360				
	Min. End/Int. Bearing (in.)				

* Indicates **Total Load** value controls.

SNOW ROOF LOAD TABLES

General Notes

- Table is based on:
 - Uniform loads (beam weight considered).
 - More restrictive of simple or continuous span.
 - Deflection criteria of L/180 total load.
- For stiffer deflection criteria, use **L/240** values for total load deflection.
- For door and window applications, **Weyerhaeuser recommends using L/360 values for live load deflection and L/240 values for total load deflection.**
- For continuous spans, ratio of short span to long span should be 0.4 or greater to prevent uplift.

Also see **How to Use This Table** on page 12 and **General Assumptions** on page 5.

TimberStrand® LSL: Roof—Snow Load Area 115% (PLF) *continued*

Span	Condition	1.55E Grade										
		1¾" Width			3½" Width				5¼" Width (2- or 3-ply)			
		9½"	11⅞"	14"	9½"	11⅞"	14"	16"	9½"	11⅞"	14"	16"
3'	Total Load	3,642	4,717	4,717	7,284	9,432	9,432	9,432	10,926	14,148	14,148	14,148
	Deflection L/240 / L/360	*/*	*/*	*/*	*/*	*/*	*/*	*/*	*/*	*/*	*/*	*/*
	Min. End/Int. Bearing (in.)	3.5/8.7	4.5/11.3	4.5/11.3	3.5/8.7	4.5/11.3	4.5/11.3	4.5/11.3	3.5/8.7	4.5/11.3	4.5/11.3	4.5/11.3
4'	Total Load	2,307	3,263	3,536	4,615	6,526	7,070	7,070	6,923	9,790	10,605	10,605
	Deflection L/240 / L/360	*/*	*/*	*/*	*/*	*/*	*/*	*/*	*/*	*/*	*/*	*/*
	Min. End/Int. Bearing (in.)	2.9/7.3	4.2/10.4	4.5/11.3	2.9/7.3	4.2/10.4	4.5/11.3	4.5/11.3	2.9/7.3	4.2/10.4	4.5/11.3	4.5/11.3
5'	Total Load	1,688	2,306	2,827	3,376	4,612	5,652	5,652	5,064	6,919	8,478	8,478
	Deflection L/240 / L/360	*/1,658	*/*	*/*	*/3,316	*/*	*/*	*/*	*/4,975	*/*	*/*	*/*
	Min. End/Int. Bearing (in.)	2.7/6.7	3.7/9.2	4.5/11.3	2.7/6.7	3.7/9.2	4.5/11.3	4.5/11.3	2.7/6.7	3.7/9.2	4.5/11.3	4.5/11.3
6'	Total Load	1,326	1,782	2,246	2,652	3,565	4,492	4,707	3,979	5,348	6,739	7,061
	Deflection L/240 / L/360	*/1,048	*/*	*/*	*/2,097	*/*	*/*	*/*	*/3,146	*/*	*/*	*/*
	Min. End/Int. Bearing (in.)	2.5/6.3	3.4/8.5	4.3/10.7	2.5/6.3	3.4/8.5	4.3/10.7	4.5/11.3	2.5/6.3	3.4/8.5	4.3/10.7	4.5/11.3
7'	Total Load	973	1,452	1,807	1,946	2,904	3,614	4,032	2,919	4,357	5,421	6,048
	Deflection L/240 / L/360	*/699	*/1,250	*/*	*/1,399	*/2,501	*/*	*/*	*/2,098	*/3,752	*/*	*/*
	Min. End/Int. Bearing (in.)	2.2/5.4	3.2/8.1	4/10.1	2.2/5.4	3.2/8.1	4/10.1	4.5/11.3	2.2/5.4	3.2/8.1	4/10.1	4.5/11.3
8'	Total Load	743	1,140	1,511	1,487	2,280	3,022	3,526	2,231	3,420	4,534	5,289
	Deflection L/240 / L/360	731/487	*/886	*/1,352	1,462/974	*/1,773	*/2,705	*/*	2,193/1,462	*/2,660	*/4,058	*/*
	Min. End/Int. Bearing (in.)	1.9/4.8	2.9/7.3	3.9/9.6	1.9/4.8	2.9/7.3	3.9/9.6	4.5/11.3	1.9/4.8	2.9/7.3	3.9/9.6	4.5/11.3
9'-6"	Total Load	525	806	1,105	1,051	1,613	2,211	2,854	1,577	2,419	3,316	4,282
	Deflection L/240 / L/360	453/302	*/560	*/870	907/605	*/1,121	*/1,740	*/2,456	1,361/907	*/1,681	*/2,610	*/3,684
	Min. End/Int. Bearing (in.)	1.6/4	2.5/6.1	3.4/8.4	1.6/4	2.5/6.1	3.4/8.4	4.3/10.8	1.6/4	2.5/6.1	3.4/8.4	4.3/10.8
10'	Total Load	474	727	996	948	1,454	1,993	2,574	1,422	2,182	2,990	3,862
	Deflection L/240 / L/360	392/261	*/487	*/760	785/523	*/974	*/1,520	*/2,154	1,178/785	*/1,462	*/2,280	*/3,232
	Min. End/Int. Bearing (in.)	1.5/3.8	2.3/5.8	3.2/8	1.5/3.8	2.3/5.8	3.2/8	4.1/10.3	1.5/3.8	2.3/5.8	3.2/8	4.1/10.3
12'	Total Load	306	503	690	612	1,006	1,380	1,782	918	1,509	2,070	2,674
	Deflection L/240 / L/360	233/155	440/293	*/464	467/311	881/587	*/928	*/1,334	700/467	1,322/881	*/1,393	*/2,001
	Min. End/Int. Bearing (in.)	1.5/3.5	1.9/4.9	2.7/6.6	1.5/3.5	1.9/4.9	2.7/6.6	3.4/8.6	1.5/3.5	1.9/4.9	2.7/6.6	3.4/8.6
14'	Total Load	194	367	504	388	735	1,009	1,305	582	1,103	1,514	1,957
	Deflection L/240 / L/360	149/99	284/189	453/302	299/199	569/379	907/605	*/877	448/299	854/569	1,361/907	*/1,316
	Min. End/Int. Bearing (in.)	1.5/3.5	1.7/4.2	2.3/5.7	1.5/3.5	1.7/4.2	2.3/5.7	2.9/7.3	1.5/3.5	1.7/4.2	2.3/5.7	2.9/7.3
16'-6"	Total Load	118	230	361	236	460	722	934	354	690	1,084	1,402
	Deflection L/240 / L/360	92/61	177/118	284/189	185/123	354/236	569/379	832/555	277/185	532/354	854/569	1,248/832
	Min. End/Int. Bearing (in.)	1.5/3.5	1.5/3.5	1.9/4.8	1.5/3.5	1.5/3.5	1.9/4.8	2.5/6.2	1.5/3.5	1.5/3.5	1.9/4.8	2.5/6.2
18'-6"	Total Load	83	163	265	166	326	531	739	249	489	797	1,109
	Deflection L/240 / L/360	66/44	127/84	205/136	132/88	254/169	410/273	601/401	198/132	381/254	615/410	902/601
	Min. End/Int. Bearing (in.)	1.5/3.5	1.5/3.5	1.6/4	1.5/3.5	1.5/3.5	1.6/4	2.2/5.6	1.5/3.5	1.5/3.5	1.6/4	2.2/5.6
20'	Total Load	64	128	210	129	257	421	624	194	385	631	936
	Deflection L/240 / L/360	52/35	101/67	163/109	105/70	202/135	327/218	481/320	157/105	304/202	491/327	722/481
	Min. End/Int. Bearing (in.)	1.5/3.5	1.5/3.5	1.5/3.5	1.5/3.5	1.5/3.5	1.5/3.5	2/5.1	1.5/3.5	1.5/3.5	1.5/3.5	2/5.1
24'	Total Load		72	120	71	145	241	361	106	217	361	542
	Deflection L/240 / L/360		59/39	96/64	61/40	118/79	192/128	284/189	91/61	177/118	288/192	426/284
	Min. End/Int. Bearing (in.)		1.5/3.5	1.5/3.5	1.5/3.5	1.5/3.5	1.5/3.5	1.5/3.6	1.5/3.5	1.5/3.5	1.5/3.5	1.5/3.6
28'	Total Load			73		87	147	224	61	130	221	336
	Deflection L/240 / L/360			61/40		75/50	122/81	181/120	58/38	112/75	183/122	271/181
	Min. End/Int. Bearing (in.)			1.5/3.5		1.5/3.5	1.5/3.5	1.5/3.5	1.5/3.5	1.5/3.5	1.5/3.5	1.5/3.5

* Indicates **Total Load** value controls.

SNOW ROOF LOAD TABLES

How to Use This Table

1. Calculate total load (neglect beam weight) on the beam or header in pounds per linear foot (plf).
2. Select appropriate **Span** (center-to-center of bearing).
3. Scan horizontally to find the proper width, and a depth with a capacity that exceeds actual total load.
4. Review bearing length requirements to ensure adequacy.

Also see **General Notes** on page 15.

2.0E Microllam® LVL: Roof—Snow Load Area 115% (PLF)

Span	Condition	1¾" Width					3½" Width (2-ply)			
		5½"	7¼"	9½"	11⅞"	14"	5½"	7¼"	9½"	11⅞"
6'	Total Load	474	877	1,223	1,638	1,961	948	1,755	2,446	3,277
	Deflection L/240	458	*	*	*	*	916	*	*	*
	Min. End/Int. Bearing (in.)	1.5/3.5	2/5	2.8/7	3.8/9.4	4.5/11.3	1.5/3.5	2/5	2.8/7	3.8/9.4
8'	Total Load	153	342	841	1,126	1,389	307	685	1,682	2,252
	Deflection L/240	*	*	*	*	*	*	*	*	*
	Min. End/Int. Bearing (in.)	1.5/3.5	1.5/3.5	2.6/6.4	3.5/8.6	4.3/10.6	1.5/3.5	1.5/3.5	2.6/6.4	3.5/8.6
9'-6"	Total Load	77	174	595	903	1,114	154	349	1,190	1,807
	Deflection L/240	*	*	585	*	*	*	*	1,171	*
	Min. End/Int. Bearing (in.)	1.5/3.5	1.5/3.5	2.2/5.4	3.3/8.2	4.1/10.2	1.5/3.5	1.5/3.5	2.2/5.4	3.3/8.2
10'	Total Load	62	142	536	814	1,045	124	284	1,073	1,629
	Deflection L/240	*	*	506	*	*	*	*	1,013	*
	Min. End/Int. Bearing (in.)	1.5/3.5	1.5/3.5	2.1/5.2	3.1/7.8	4/10	1.5/3.5	1.5/3.5	2.1/5.2	3.1/7.8
12'	Total Load		67	371	564	767	57	135	742	1,128
	Deflection L/240		*	301	*	*	*	*	602	*
	Min. End/Int. Bearing (in.)		1.5/3.5	1.7/4.3	2.6/6.5	3.5/8.9	1.5/3.5	1.5/3.5	1.7/4.3	2.6/6.5
14'	Total Load			252	412	562		70	505	825
	Deflection L/240			193	367	*		*	386	734
	Min. End/Int. Bearing (in.)			1.5/3.5	2.2/5.6	3/7.6		1.5/3.5	1.5/3.5	2.2/5.6
16'-6"	Total Load			154	295	402			308	591
	Deflection L/240			119	228	367			238	457
	Min. End/Int. Bearing (in.)			1.5/3.5	1.9/4.7	2.6/6.4			1.5/3.5	1.9/4.7
18'-6"	Total Load			108	212	318			217	425
	Deflection L/240			85	164	264			170	328
	Min. End/Int. Bearing (in.)			1.5/3.5	1.5/3.9	2.3/5.7			1.5/3.5	1.5/3.9
20'	Total Load			85	168	271			171	336
	Deflection L/240			67	130	211			135	261
	Min. End/Int. Bearing (in.)			1.5/3.5	1.5/3.5	2.1/5.3			1.5/3.5	1.5/3.5
22'	Total Load			63	125	206			126	251
	Deflection L/240			51	98	160			102	197
	Min. End/Int. Bearing (in.)			1.5/3.5	1.5/3.5	1.8/4.5			1.5/3.5	1.5/3.5
24'	Total Load				95	158			95	191
	Deflection L/240				76	124			79	153
	Min. End/Int. Bearing (in.)				1.5/3.5	1.5/3.8			1.5/3.5	1.5/3.5
26'	Total Load				74	123			73	148
	Deflection L/240				60	98			62	120
	Min. End/Int. Bearing (in.)				1.5/3.5	1.5/3.5			1.5/3.5	1.5/3.5
28'	Total Load				58	98			56	117
	Deflection L/240				48	78			50	97
	Min. End/Int. Bearing (in.)				1.5/3.5	1.5/3.5			1.5/3.5	1.5/3.5
30'	Total Load					78				93
	Deflection L/240					64				79
	Min. End/Int. Bearing (in.)					1.5/3.5				1.5/3.5

* Indicates **Total Load** value controls.

SNOW ROOF LOAD TABLES

General Notes

- Table is based on:
 - Uniform loads (beam weight considered).
 - More restrictive of simple or continuous span.
 - Deflection criteria of L/180 total load.
- For stiffer deflection criteria, use **L/240** values for total load deflection.
- For continuous spans, ratio of short span to long span should be 0.4 or greater to prevent uplift.

Also see **How to Use This Table** on page 14 and **General Assumptions** on page 5.

2.0E Microllam® LVL: Roof—Snow Load Area 115% (PLF) *continued*

Span	Condition	3½" Width (2-ply)			5¼" Width (3-ply)						
		14"	16"	18"	5½"	7¼"	9½"	11⅞"	14"	16"	18"
6'	Total Load	3,919	3,919	3,919	1,423	2,632	3,669	4,916	5,878	5,878	5,878
	Deflection L/240	*	*	*	1,374	*	*	*	*	*	*
	Min. End/Int. Bearing (in.)	4.5/11.3	4.5/11.3	4.5/11.3	1.5/3.5	2/5	2.8/7	3.8/9.4	4.5/11.3	4.5/11.3	4.5/11.3
8'	Total Load	2,778	2,934	2,934	461	1,028	2,524	3,378	4,168	4,402	4,402
	Deflection L/240	*	*	*	*	*	*	*	*	*	*
	Min. End/Int. Bearing (in.)	4.3/10.6	4.5/11.3	4.5/11.3	1.5/3.5	1.5/3.5	2.6/6.4	3.5/8.6	4.3/10.6	4.5/11.3	4.5/11.3
9'-6"	Total Load	2,229	2,468	2,468	231	524	1,785	2,710	3,344	3,702	3,702
	Deflection L/240	*	*	*	*	*	1,757	*	*	*	*
	Min. End/Int. Bearing (in.)	4.1/10.2	4.5/11.3	4.5/11.3	1.5/3.5	1.5/3.5	2.2/5.4	3.3/8.2	4.1/10.2	4.5/11.3	4.5/11.3
10'	Total Load	2,091	2,344	2,344	187	427	1,610	2,444	3,137	3,516	3,516
	Deflection L/240	*	*	*	*	*	1,520	*	*	*	*
	Min. End/Int. Bearing (in.)	4/10	4.5/11.3	4.5/11.3	1.5/3.5	1.5/3.5	2.1/5.2	3.1/7.8	4/10	4.5/11.3	4.5/11.3
12'	Total Load	1,535	1,950	1,950	86	203	1,113	1,692	2,303	2,925	2,925
	Deflection L/240	*	*	*	*	*	904	*	*	*	*
	Min. End/Int. Bearing (in.)	3.5/8.9	4.5/11.3	4.5/11.3	1.5/3.5	1.5/3.5	1.7/4.3	2.6/6.5	3.5/8.9	4.5/11.3	4.5/11.3
14'	Total Load	1,124	1,444	1,669		106	757	1,238	1,686	2,166	2,503
	Deflection L/240	*	*	*		*	579	1,102	*	*	*
	Min. End/Int. Bearing (in.)	3/7.6	3.9/9.7	4.5/11.3		1.5/3.5	1.5/3.5	2.2/5.6	3/7.6	3.9/9.7	4.5/11.3
16'-6"	Total Load	805	1,035	1,291			463	886	1,208	1,552	1,936
	Deflection L/240	735	*	*			358	686	1,103	*	*
	Min. End/Int. Bearing (in.)	2.6/6.4	3.3/8.3	4.1/10.3			1.5/3.5	1.9/4.7	2.6/6.4	3.3/8.3	4.1/10.3
18'-6"	Total Load	637	820	1,023			326	638	956	1,230	1,535
	Deflection L/240	529	776	*			256	492	794	1,164	*
	Min. End/Int. Bearing (in.)	2.3/5.7	2.9/7.4	3.7/9.2			1.5/3.5	1.5/3.9	2.3/5.7	2.9/7.4	3.7/9.2
20'	Total Load	543	699	872			256	504	815	1,048	1,309
	Deflection L/240	422	621	869			203	392	633	931	1,304
	Min. End/Int. Bearing (in.)	2.1/5.3	2.7/6.8	3.4/8.5			1.5/3.5	1.5/3.5	2.1/5.3	2.7/6.8	3.4/8.5
22'	Total Load	412	575	718			190	377	619	862	1,077
	Deflection L/240	320	472	662			153	296	480	708	994
	Min. End/Int. Bearing (in.)	1.8/4.5	2.5/6.2	3.1/7.7			1.5/3.5	1.5/3.5	1.8/4.5	2.5/6.2	3.1/7.7
24'	Total Load	316	472	600			143	287	475	708	900
	Deflection L/240	248	366	515			118	229	372	550	773
	Min. End/Int. Bearing (in.)	1.5/3.8	2.2/5.6	2.8/7.1			1.5/3.5	1.5/3.5	1.5/3.8	2.2/5.6	2.8/7.1
26'	Total Load	247	370	509			110	223	371	556	763
	Deflection L/240	196	290	409			93	181	294	435	613
	Min. End/Int. Bearing (in.)	1.5/3.5	1.9/4.8	2.6/6.5			1.5/3.5	1.5/3.5	1.5/3.5	1.9/4.8	2.6/6.5
28'	Total Load	196	295	421			85	175	294	442	632
	Deflection L/240	157	233	329			75	145	236	350	494
	Min. End/Int. Bearing (in.)	1.5/3.5	1.7/4.2	2.3/5.9			1.5/3.5	1.5/3.5	1.5/3.5	1.7/4.2	2.3/5.9
30'	Total Load	157	238	341			66	139	236	357	511
	Deflection L/240	128	190	269			61	118	193	286	404
	Min. End/Int. Bearing (in.)	1.5/3.5	1.5/3.6	2.1/5.1			1.5/3.5	1.5/3.5	1.5/3.5	1.5/3.6	2.1/5.1

* Indicates Total Load value controls.

SNOW ROOF LOAD TABLES

How to Use This Table

1. Calculate total load (neglect beam weight) on the beam or header in pounds per linear foot (plf).
2. Select appropriate **Span** (center-to-center of bearing).
3. Scan horizontally to find the proper width, and a depth with a capacity that exceeds actual total load.
4. Review bearing length requirements to ensure adequacy.

Also see **General Notes** on page 17.

2.2E Parallam® PSL: Roof—Snow Load Area 115% (PLF)

Span	Condition	3½" Width						5¼" Width							
		9¼"	9½"	11¼"	11⅞"	14"	16"	18"	9¼"	9½"	11¼"	11⅞"	14"	16"	18"
8'	Total Load	1,691	1,746	2,142	2,291	2,441	2,441	2,441	2,537	2,619	3,213	3,436	3,661	3,661	3,661
	Deflection L/240	*	*	*	*	*	*	*	*	*	*	*	*	*	*
	Min. End/Int. Bearing (in.)	3.1/7.8	3.2/8	3.9/9.9	4.2/10.5	4.5/11.3	4.5/11.3	4.5/11.3	3.1/7.8	3.2/8	3.9/9.9	4.2/10.5	4.5/11.3	4.5/11.3	4.5/11.3
9'-6"	Total Load	1,255	1,320	1,738	1,854	2,052	2,052	2,052	1,883	1,980	2,607	2,781	3,079	3,079	3,079
	Deflection L/240	1,195	1,288	*	*	*	*	*	1,793	1,932	*	*	*	*	*
	Min. End/Int. Bearing (in.)	2.7/6.9	2.9/7.2	3.8/9.5	4.1/10.1	4.5/11.3	4.5/11.3	4.5/11.3	2.7/6.9	2.9/7.2	3.8/9.5	4.1/10.1	4.5/11.3	4.5/11.3	4.5/11.3
10'	Total Load	1,132	1,190	1,635	1,743	1,949	1,949	1,949	1,698	1,786	2,453	2,615	2,923	2,923	2,923
	Deflection L/240	1,034	1,115	*	*	*	*	*	1,551	1,672	*	*	*	*	*
	Min. End/Int. Bearing (in.)	2.6/6.5	2.7/6.9	3.8/9.4	4/10	4.5/11.3	4.5/11.3	4.5/11.3	2.6/6.5	2.7/6.9	3.8/9.4	4/10	4.5/11.3	4.5/11.3	4.5/11.3
12'	Total Load	783	823	1,135	1,258	1,620	1,620	1,620	1,174	1,235	1,703	1,887	2,431	2,431	2,431
	Deflection L/240	614	663	1,074	1,251	*	*	*	921	994	1,611	1,876	*	*	*
	Min. End/Int. Bearing (in.)	2.2/5.4	2.3/5.7	3.1/7.9	3.5/8.7	4.5/11.3	4.5/11.3	4.5/11.3	2.2/5.4	2.3/5.7	3.1/7.9	3.5/8.7	4.5/11.3	4.5/11.3	4.5/11.3
14'	Total Load	513	555	831	921	1,259	1,386	1,386	770	833	1,246	1,381	1,889	2,079	2,079
	Deflection L/240	392	424	692	808	*	*	*	589	637	1,038	1,212	*	*	*
	Min. End/Int. Bearing (in.)	1.7/4.2	1.8/4.5	2.7/6.7	3/7.5	4.1/10.2	4.5/11.3	4.5/11.3	1.7/4.2	1.8/4.5	2.7/6.7	3/7.5	4.1/10.2	4.5/11.3	4.5/11.3
16'-6"	Total Load	313	340	561	658	902	1,163	1,173	470	510	842	987	1,353	1,745	1,760
	Deflection L/240	243	262	430	503	808	*	*	364	394	645	755	1,213	*	*
	Min. End/Int. Bearing (in.)	1.5/3.5	1.5/3.5	2.2/5.4	2.5/6.3	3.5/8.7	4.5/11.1	4.5/11.3	1.5/3.5	1.5/3.5	2.2/5.4	2.5/6.3	3.5/8.7	4.5/11.1	4.5/11.3
18'-6"	Total Load	221	240	399	468	714	922	1,044	332	360	598	703	1,072	1,383	1,566
	Deflection L/240	173	187	308	361	582	854	*	260	281	462	541	873	1,281	*
	Min. End/Int. Bearing (in.)	1.5/3.5	1.5/3.5	1.7/4.3	2/5.1	3.1/7.7	4/9.9	4.5/11.3	1.5/3.5	1.5/3.5	1.7/4.3	2/5.1	3.1/7.7	4/9.9	4.5/11.3
20'	Total Load	173	188	315	370	604	786	964	260	282	472	555	906	1,179	1,447
	Deflection L/240	137	149	245	287	464	683	956	206	223	368	431	697	1,025	1,435
	Min. End/Int. Bearing (in.)	1.5/3.5	1.5/3.5	1.5/3.7	1.8/4.4	2.8/7.1	3.7/9.2	4.5/11.3	1.5/3.5	1.5/3.5	1.5/3.7	1.8/4.4	2.8/7.1	3.7/9.2	4.5/11.3
22'	Total Load	128	139	235	276	454	646	810	192	209	352	415	681	970	1,215
	Deflection L/240	104	112	185	217	352	519	728	156	168	278	326	528	778	1,093
	Min. End/Int. Bearing (in.)	1.5/3.5	1.5/3.5	1.5/3.5	1.5/3.6	2.4/5.9	3.3/8.4	4.2/10.4	1.5/3.5	1.5/3.5	1.5/3.5	1.5/3.6	2.4/5.9	3.3/8.4	4.2/10.4
24'	Total Load	97	105	179	211	348	520	677	145	158	268	317	523	780	1,016
	Deflection L/240	80	86	143	168	273	403	567	120	130	215	252	409	605	851
	Min. End/Int. Bearing (in.)	1.5/3.5	1.5/3.5	1.5/3.5	1.5/3.5	2/5	3/7.4	3.8/9.6	1.5/3.5	1.5/3.5	1.5/3.5	1.5/3.5	2/5	3/7.4	3.8/9.6
26'	Total Load	74	81	138	164	272	408	574	111	121	208	246	408	612	861
	Deflection L/240	63	68	113	132	215	319	450	95	102	169	199	323	479	675
	Min. End/Int. Bearing (in.)	1.5/3.5	1.5/3.5	1.5/3.5	1.5/3.5	1.7/4.3	2.5/6.3	3.5/8.8	1.5/3.5	1.5/3.5	1.5/3.5	1.5/3.5	1.7/4.3	2.5/6.3	3.5/8.8
28'	Total Load	57	62	108	129	216	325	464	86	94	163	193	324	487	696
	Deflection L/240	50	55	90	106	173	257	362	76	82	136	160	260	385	544
	Min. End/Int. Bearing (in.)	1.5/3.5	1.5/3.5	1.5/3.5	1.5/3.5	1.5/3.7	2.2/5.5	3.1/7.7	1.5/3.5	1.5/3.5	1.5/3.5	1.5/3.5	1.5/3.7	2.2/5.5	3.1/7.7
30'	Total Load			86	102	173	262	375	67	74	129	154	260	393	563
	Deflection L/240			74	86	141	209	296	62	67	111	130	212	314	444
	Min. End/Int. Bearing (in.)			1.5/3.5	1.5/3.5	1.5/3.5	1.9/4.8	2.7/6.8	1.5/3.5	1.5/3.5	1.5/3.5	1.5/3.5	1.5/3.5	1.9/4.8	2.7/6.8
32'	Total Load			69	82	140	213	307	53	58	103	124	211	320	461
	Deflection L/240			61	71	117	173	245	51	55	91	107	175	260	368
	Min. End/Int. Bearing (in.)			1.5/3.5	1.5/3.5	1.5/3.5	1.7/4.2	2.4/6	1.5/3.5	1.5/3.5	1.5/3.5	1.5/3.5	1.5/3.5	1.7/4.2	2.4/6

* Indicates Total Load value controls.

SNOW ROOF LOAD TABLES

General Notes

- Table is based on:
 - Uniform loads (beam weight considered).
 - More restrictive of simple or continuous span.
 - Deflection criteria of L/180 total load.
- For stiffer deflection criteria, use **L/240** values for total load deflection.
- For continuous spans, ratio of short span to long span should be 0.4 or greater to prevent uplift.

Also see **How to Use This Table** on page 16 and **General Assumptions** on page 5.

2.2E Parallam® PSL: Roof—Snow Load Area 115% (PLF) *continued*

Span	Condition	7" Width						
		9¼"	9½"	11¼"	11⅞"	14"	16"	18"
8'	Total Load	3,383	3,492	4,285	4,582	4,882	4,882	4,882
	Deflection L/240	*	*	*	*	*	*	*
	Min. End/Int. Bearing (in.)	3.1/7.8	3.2/8	3.9/9.9	4.2/10.5	4.5/11.3	4.5/11.3	4.5/11.3
9'-6"	Total Load	2,511	2,641	3,477	3,709	4,105	4,105	4,105
	Deflection L/240	2,390	2,576	*	*	*	*	*
	Min. End/Int. Bearing (in.)	2.7/6.9	2.9/7.2	3.8/9.5	4.1/10.1	4.5/11.3	4.5/11.3	4.5/11.3
10'	Total Load	2,264	2,381	3,271	3,487	3,898	3,898	3,898
	Deflection L/240	2,068	2,230	*	*	*	*	*
	Min. End/Int. Bearing (in.)	2.6/6.5	2.7/6.9	3.8/9.4	4/10	4.5/11.3	4.5/11.3	4.5/11.3
12'	Total Load	1,566	1,647	2,271	2,517	3,241	3,241	3,241
	Deflection L/240	1,228	1,326	2,148	2,502	*	*	*
	Min. End/Int. Bearing (in.)	2.2/5.4	2.3/5.7	3.1/7.9	3.5/8.7	4.5/11.3	4.5/11.3	4.5/11.3
14'	Total Load	1,027	1,111	1,662	1,842	2,519	2,773	2,773
	Deflection L/240	785	849	1,384	1,616	*	*	*
	Min. End/Int. Bearing (in.)	1.7/4.2	1.8/4.5	2.7/6.7	3/7.5	4.1/10.2	4.5/11.3	4.5/11.3
16'-6"	Total Load	627	680	1,123	1,317	1,805	2,327	2,346
	Deflection L/240	486	525	861	1,007	1,617	*	*
	Min. End/Int. Bearing (in.)	1.5/3.5	1.5/3.5	2.2/5.4	2.5/6.3	3.5/8.7	4.5/11.1	4.5/11.3
18'-6"	Total Load	442	480	798	937	1,429	1,844	2,089
	Deflection L/240	347	375	616	722	1,164	1,708	*
	Min. End/Int. Bearing (in.)	1.5/3.5	1.5/3.5	1.7/4.3	2/5.1	3.1/7.7	4/9.9	4.5/11.3
20'	Total Load	347	377	630	741	1,208	1,572	1,929
	Deflection L/240	275	298	490	575	929	1,366	1,913
	Min. End/Int. Bearing (in.)	1.5/3.5	1.5/3.5	1.5/3.7	1.8/4.4	2.8/7.1	3.7/9.2	4.5/11.3
22'	Total Load	257	279	470	553	908	1,293	1,620
	Deflection L/240	208	225	370	434	704	1,038	1,457
	Min. End/Int. Bearing (in.)	1.5/3.5	1.5/3.5	1.5/3.5	1.5/3.6	2.4/5.9	3.3/8.4	4.2/10.4
24'	Total Load	194	211	358	422	697	1,040	1,355
	Deflection L/240	160	173	287	336	546	806	1,135
	Min. End/Int. Bearing (in.)	1.5/3.5	1.5/3.5	1.5/3.5	1.5/3.5	2/5	3/7.4	3.8/9.6
26'	Total Load	148	162	277	328	545	816	1,149
	Deflection L/240	126	137	226	265	431	638	900
	Min. End/Int. Bearing (in.)	1.5/3.5	1.5/3.5	1.5/3.5	1.5/3.5	1.7/4.3	2.5/6.3	3.5/8.8
28'	Total Load	115	125	217	258	432	650	928
	Deflection L/240	101	110	181	213	347	514	725
	Min. End/Int. Bearing (in.)	1.5/3.5	1.5/3.5	1.5/3.5	1.5/3.5	1.5/3.7	2.2/5.5	3.1/7.7
30'	Total Load	90	98	172	205	347	524	751
	Deflection L/240	82	89	148	173	283	419	593
	Min. End/Int. Bearing (in.)	1.5/3.5	1.5/3.5	1.5/3.5	1.5/3.5	1.5/3.5	1.9/4.8	2.7/6.8
32'	Total Load	70	77	138	165	281	427	615
	Deflection L/240	68	73	122	143	234	347	490
	Min. End/Int. Bearing (in.)	1.5/3.5	1.5/3.5	1.5/3.5	1.5/3.5	1.5/3.5	1.7/4.2	2.4/6

* Indicates Total Load value controls.

NON-SNOW ROOF LOAD TABLES

How to Use This Table

1. Calculate total load (neglect beam weight) on the beam or header in pounds per linear foot (plf).
2. Select appropriate **Span** (center-to-center of bearing).
3. Scan horizontally to find the proper width, and a depth with a capacity that exceeds actual total load.
4. Review bearing length requirements to ensure adequacy.

Also see **General Notes** on page 19.

TimberStrand® LSL: Roof—Non-Snow Load Area 125% (PLF)

Span	Condition	1.3E Grade			
		3½" Width			5½" Plank Orientation
		4¾"	5½"	7¼"	3½"
3'	Total Load	1,924	2,978	5,047	1,514
	Deflection L/240 / L/360	*1,420	*2,547	*4,885	*1,224
	Min. End/Int. Bearing (in.)	1.5/3.5	1.8/4.5	3.1/7.6	1.5/3.5
4'	Total Load	1,080	1,673	2,836	1,084
	Deflection L/240 / L/360	977/651	*1,215	*2,476	820/546
	Min. End/Int. Bearing (in.)	1.5/3.5	1.5/3.5	2.3/5.7	1.5/3.5
5'	Total Load	647	1,068	1,812	533
	Deflection L/240 / L/360	521/347	993/662	*1,398	431/287
	Min. End/Int. Bearing (in.)	1.5/3.5	1.5/3.5	1.8/4.6	1.5/3.5
6'	Total Load	317	614	1,256	258
	Deflection L/240 / L/360	309/206	595/397	*857	253/169
	Min. End/Int. Bearing (in.)	1.5/3.5	1.5/3.5	1.5/3.8	1.5/3.5
7'	Total Load	171	336	742	138
	Deflection L/240 / L/360	*131	*255	*560	*107
	Min. End/Int. Bearing (in.)	1.5/3.5	1.5/3.5	1.5/3.5	1.5/3.5
8'	Total Load	99	198	443	79
	Deflection L/240 / L/360	*89	*173	*384	*72
	Min. End/Int. Bearing (in.)	1.5/3.5	1.5/3.5	1.5/3.5	1.5/3.5
9'-6"	Total Load		98	224	
	Deflection L/240 / L/360		*/*	*/*	
	Min. End/Int. Bearing (in.)		1.5/3.5	1.5/3.5	
10'	Total Load		79	182	
	Deflection L/240 / L/360		*/*	*/*	
	Min. End/Int. Bearing (in.)		1.5/3.5	1.5/3.5	
12'	Total Load			85	
	Deflection L/240 / L/360			*/*	
	Min. End/Int. Bearing (in.)			1.5/3.5	
14'	Total Load				
	Deflection L/240 / L/360				
	Min. End/Int. Bearing (in.)				
16'-6"	Total Load				
	Deflection L/240 / L/360				
	Min. End/Int. Bearing (in.)				
18'-6"	Total Load				
	Deflection L/240 / L/360				
	Min. End/Int. Bearing (in.)				
20'	Total Load				
	Deflection L/240 / L/360				
	Min. End/Int. Bearing (in.)				
24'	Total Load				
	Deflection L/240 / L/360				
	Min. End/Int. Bearing (in.)				
28'	Total Load				
	Deflection L/240 / L/360				
	Min. End/Int. Bearing (in.)				

* Indicates **Total Load** value controls.

NON-SNOW ROOF LOAD TABLES

General Notes

- Table is based on:
 - Uniform loads (beam weight considered).
 - More restrictive of simple or continuous span.
 - Deflection criteria of L/180 total load.
- For stiffer deflection criteria, use **L/240** values for total load deflection.
- For door and window applications, **Weyerhaeuser recommends using L/360 values for live load deflection and L/240 values for total load deflection.**
- For continuous spans, ratio of short span to long span should be 0.4 or greater to prevent uplift.

Also see **How to Use This Table** on page 18 and **General Assumptions** on page 5.

TimberStrand® LSL: Roof—Non-Snow Load Area 125% (PLF) *continued*

Span	Condition	1.55E Grade											
		1¾" Width			3½" Width				5¼" Width (2- or 3-ply)				
		9½"	11½"	14"	9½"	11½"	14"	16"	9½"	11½"	14"	16"	
3'	Total Load	3,959	4,717	4,717	7,918	9,432	9,432	9,432	11,877	14,148	14,148	14,148	
	Deflection L/240 / L/360	*/*	*/*	*/*	*/*	*/*	*/*	*/*	*/*	*/*	*/*	*/*	
	Min. End/Int. Bearing (in.)	3.8/9.4	4.5/11.3	4.5/11.3	3.8/9.4	4.5/11.3	4.5/11.3	4.5/11.3	3.8/9.4	4.5/11.3	4.5/11.3	4.5/11.3	
4'	Total Load	2,508	3,536	3,536	5,017	7,070	7,070	7,070	7,526	10,605	10,605	10,605	
	Deflection L/240 / L/360	*/*	*/*	*/*	*/*	*/*	*/*	*/*	*/*	*/*	*/*	*/*	
	Min. End/Int. Bearing (in.)	3.2/8	4.5/11.3	4.5/11.3	3.2/8	4.5/11.3	4.5/11.3	4.5/11.3	3.2/8	4.5/11.3	4.5/11.3	4.5/11.3	
5'	Total Load	1,835	2,507	2,827	3,670	5,015	5,652	5,652	5,506	7,522	8,478	8,478	
	Deflection L/240 / L/360	*/1,658	*/*	*/*	*/3,316	*/*	*/*	*/*	*/4,975	*/*	*/*	*/*	
	Min. End/Int. Bearing (in.)	2.9/7.3	4/10	4.5/11.3	2.9/7.3	4/10	4.5/11.3	4.5/11.3	2.9/7.3	4/10	4.5/11.3	4.5/11.3	
6'	Total Load	1,442	1,938	2,354	2,884	3,876	4,707	4,707	4,326	5,814	7,061	7,061	
	Deflection L/240 / L/360	*/1,048	*/1,831	*/*	*/2,097	*/3,662	*/*	*/*	*/3,146	*/5,493	*/*	*/*	
	Min. End/Int. Bearing (in.)	2.8/6.9	3.7/9.3	4.5/11.3	2.8/6.9	3.7/9.3	4.5/11.3	4.5/11.3	2.8/6.9	3.7/9.3	4.5/11.3	4.5/11.3	
7'	Total Load	1,058	1,579	1,965	2,116	3,158	3,930	4,032	3,174	4,737	5,895	6,048	
	Deflection L/240 / L/360	1,049/699	*/1,250	*/1,877	2,098/1,399	*/2,501	*/3,755	*/*	3,148/2,098	*/3,752	*/5,633	*/*	
	Min. End/Int. Bearing (in.)	2.4/5.9	3.5/8.8	4.4/11	2.4/5.9	3.5/8.8	4.4/11	4.5/11.3	2.4/5.9	3.5/8.8	4.4/11	4.5/11.3	
8'	Total Load	809	1,239	1,643	1,618	2,479	3,286	3,526	2,427	3,719	4,930	5,289	
	Deflection L/240 / L/360	731/487	*/886	*/1,352	1,462/974	*/1,773	*/2,705	*/*	2,193/1,462	*/2,660	*/4,058	*/*	
	Min. End/Int. Bearing (in.)	2.1/5.2	3.2/7.9	4.2/10.5	2.1/5.2	3.2/7.9	4.2/10.5	4.5/11.3	2.1/5.2	3.2/7.9	4.2/10.5	4.5/11.3	
9'-6"	Total Load	572	877	1,202	1,144	1,754	2,404	2,966	1,716	2,631	3,606	4,450	
	Deflection L/240 / L/360	453/302	840/560	*/870	907/605	1,681/1,121	*/1,740	*/2,456	1,361/907	2,522/1,681	*/2,610	*/3,684	
	Min. End/Int. Bearing (in.)	1.7/4.4	2.7/6.7	3.6/9.1	1.7/4.4	2.7/6.7	3.6/9.1	4.5/11.3	1.7/4.4	2.7/6.7	3.6/9.1	4.5/11.3	
10'	Total Load	515	791	1,084	1,031	1,582	2,168	2,800	1,547	2,373	3,253	4,200	
	Deflection L/240 / L/360	392/261	731/487	*/760	785/523	1,462/974	*/1,520	*/2,154	1,178/785	2,193/1,462	*/2,280	*/3,232	
	Min. End/Int. Bearing (in.)	1.7/4.1	2.5/6.3	3.5/8.7	1.7/4.1	2.5/6.3	3.5/8.7	4.5/11.2	1.7/4.1	2.5/6.3	3.5/8.7	4.5/11.2	
12'	Total Load	306	547	750	612	1,094	1,501	1,939	918	1,642	2,252	2,908	
	Deflection L/240 / L/360	233/155	440/293	696/464	467/311	881/587	1,393/928	*/1,334	700/467	1,322/881	2,089/1,393	*/2,001	
	Min. End/Int. Bearing (in.)	1.5/3.5	2.1/5.3	2.9/7.2	1.5/3.5	2.1/5.3	2.9/7.2	3.7/9.3	1.5/3.5	2.1/5.3	2.9/7.2	3.7/9.3	
14'	Total Load	194	373	549	388	746	1,098	1,420	582	1,119	1,648	2,130	
	Deflection L/240 / L/360	149/99	284/189	453/302	299/199	569/379	907/605	1,316/877	448/299	854/569	1,361/907	1,974/1,316	
	Min. End/Int. Bearing (in.)	1.5/3.5	1.7/4.2	2.5/6.2	1.5/3.5	1.7/4.2	2.5/6.2	3.2/8	1.5/3.5	1.7/4.2	2.5/6.2	3.2/8	
16'-6"	Total Load	118	230	372	236	460	744	1,017	354	690	1,116	1,526	
	Deflection L/240 / L/360	92/61	177/118	284/189	185/123	354/236	569/379	832/555	277/185	532/354	854/569	1,248/832	
	Min. End/Int. Bearing (in.)	1.5/3.5	1.5/3.5	2/5	1.5/3.5	1.5/3.5	2/5	2.7/6.8	1.5/3.5	1.5/3.5	2/5	2.7/6.8	
18'-6"	Total Load	83	163	265	166	326	531	785	249	489	797	1,177	
	Deflection L/240 / L/360	66/44	127/84	205/136	132/88	254/169	410/273	601/401	198/132	381/254	615/410	902/601	
	Min. End/Int. Bearing (in.)	1.5/3.5	1.5/3.5	1.6/4	1.5/3.5	1.5/3.5	1.6/4	2.4/5.9	1.5/3.5	1.5/3.5	1.6/4	2.4/5.9	
20'	Total Load	64	128	210	129	257	421	624	194	385	631	936	
	Deflection L/240 / L/360	52/35	101/67	163/109	105/70	202/135	327/218	481/320	157/105	304/202	491/327	722/481	
	Min. End/Int. Bearing (in.)	1.5/3.5	1.5/3.5	1.5/3.5	1.5/3.5	1.5/3.5	1.5/3.5	2/5.1	1.5/3.5	1.5/3.5	1.5/3.5	2/5.1	
24'	Total Load		72	120	71	145	241	361	106	217	361	542	
	Deflection L/240 / L/360		59/39	96/64	61/40	118/79	192/128	284/189	91/61	177/118	288/192	426/284	
	Min. End/Int. Bearing (in.)		1.5/3.5	1.5/3.5	1.5/3.5	1.5/3.5	1.5/3.5	1.5/3.6	1.5/3.5	1.5/3.5	1.5/3.5	1.5/3.6	
28'	Total Load			73		87	147	224	61	130	221	336	
	Deflection L/240 / L/360			61/40		75/50	122/81	181/120	58/38	112/75	183/122	271/181	
	Min. End/Int. Bearing (in.)			1.5/3.5		1.5/3.5	1.5/3.5	1.5/3.5	1.5/3.5	1.5/3.5	1.5/3.5	1.5/3.5	

* Indicates Total Load value controls.

NON-SNOW ROOF LOAD TABLES

How to Use This Table

1. Calculate total load (neglect beam weight) on the beam or header in pounds per linear foot (plf).
2. Select appropriate **Span** (center-to-center of bearing).
3. Scan horizontally to find the proper width, and a depth with a capacity that exceeds actual total load.
4. Review bearing length requirements to ensure adequacy.

Also see **General Notes** on page 21.

2.OE Microllam® LVL: Roof—Non-Snow Load Area 125% (PLF)

Span	Condition	1¾" Width					3½" Width (2 ply)			
		5½"	7¼"	9½"	11⅞"	14"	5½"	7¼"	9½"	11⅞"
6'	Total Load	474	954	1,329	1,781	1,961	948	1,908	2,659	3,563
	Deflection L/240	458	*	*	*	*	916	*	*	*
	Min. End/Int. Bearing (in.)	1.5/3.5	2.2/5.5	3.1/7.6	4.1/10.2	4.5/11.3	1.5/3.5	2.2/5.5	3.1/7.6	4.1/10.2
8'	Total Load	153	342	915	1,224	1,469	307	685	1,830	2,449
	Deflection L/240	*	*	*	*	*	*	*	*	*
	Min. End/Int. Bearing (in.)	1.5/3.5	1.5/3.5	2.8/7	3.8/9.4	4.5/11.3	1.5/3.5	1.5/3.5	2.8/7	3.8/9.4
9'-6"	Total Load	77	174	647	982	1,212	154	349	1,294	1,965
	Deflection L/240	*	*	585	*	*	*	*	1,171	*
	Min. End/Int. Bearing (in.)	1.5/3.5	1.5/3.5	2.4/5.9	3.6/8.9	4.4/11	1.5/3.5	1.5/3.5	2.4/5.9	3.6/8.9
10'	Total Load	62	142	583	886	1,137	124	284	1,167	1,772
	Deflection L/240	*	*	506	*	*	*	*	1,013	*
	Min. End/Int. Bearing (in.)	1.5/3.5	1.5/3.5	2.2/5.6	3.4/8.5	4.4/10.9	1.5/3.5	1.5/3.5	2.2/5.6	3.4/8.5
12'	Total Load		67	397	613	835	57	135	794	1,227
	Deflection L/240		*	301	568	*	*	*	602	1,137
	Min. End/Int. Bearing (in.)		1.5/3.5	1.8/4.6	2.8/7.1	3.9/9.6	1.5/3.5	1.5/3.5	1.8/4.6	2.8/7.1
14'	Total Load			252	449	611		70	505	898
	Deflection L/240			193	367	585		*	386	734
	Min. End/Int. Bearing (in.)			1.5/3.5	2.4/6.1	3.3/8.3		1.5/3.5	1.5/3.5	2.4/6.1
16'-6"	Total Load			154	299	438			308	598
	Deflection L/240			119	228	367			238	457
	Min. End/Int. Bearing (in.)			1.5/3.5	1.9/4.8	2.8/7			1.5/3.5	1.9/4.8
18'-6"	Total Load			108	212	345			217	425
	Deflection L/240			85	164	264			170	328
	Min. End/Int. Bearing (in.)			1.5/3.5	1.5/3.9	2.5/6.2			1.5/3.5	1.5/3.9
20'	Total Load			85	168	274			171	336
	Deflection L/240			67	130	211			135	261
	Min. End/Int. Bearing (in.)			1.5/3.5	1.5/3.5	2.1/5.4			1.5/3.5	1.5/3.5
22'	Total Load			63	125	206			126	251
	Deflection L/240			51	98	160			102	197
	Min. End/Int. Bearing (in.)			1.5/3.5	1.5/3.5	1.8/4.5			1.5/3.5	1.5/3.5
24'	Total Load				95	158			95	191
	Deflection L/240				76	124			79	153
	Min. End/Int. Bearing (in.)				1.5/3.5	1.5/3.8			1.5/3.5	1.5/3.5
26'	Total Load				74	123			73	148
	Deflection L/240				60	98			62	120
	Min. End/Int. Bearing (in.)				1.5/3.5	1.5/3.5			1.5/3.5	1.5/3.5
28'	Total Load				58	98			56	117
	Deflection L/240				48	78			50	97
	Min. End/Int. Bearing (in.)				1.5/3.5	1.5/3.5			1.5/3.5	1.5/3.5
30'	Total Load					78				93
	Deflection L/240					64				79
	Min. End/Int. Bearing (in.)					1.5/3.5				1.5/3.5

* Indicates **Total Load** value controls.

NON-SNOW ROOF LOAD TABLES

General Notes

- Table is based on:
 - Uniform loads (beam weight considered).
 - More restrictive of simple or continuous span.
 - Deflection criteria of L/180 total load.
- For stiffer deflection criteria, use **L/240** values for total load deflection.
- For continuous spans, ratio of short span to long span should be 0.4 or greater to prevent uplift.

Also see **How to Use This Table** on page 20 and **General Assumptions** on page 5.

2.OE Microllam® LVL: Roof—Non-Snow Load Area 125% (PLF) *continued*

Span	Condition	3½" Width (2-ply)			5¼" Width (3-ply)						
		14"	16"	18"	5½"	7¼"	9½"	11½"	14"	16"	18"
6'	Total Load	3,919	3,919	3,919	1,423	2,862	3,989	5,345	5,878	5,878	5,878
	Deflection L/240	*	*	*	1,374	*	*	*	*	*	*
	Min. End/Int. Bearing (in.)	4.5/11.3	4.5/11.3	4.5/11.3	1.5/3.5	2.2/5.5	3.1/7.6	4.1/10.2	4.5/11.3	4.5/11.3	4.5/11.3
8'	Total Load	2,934	2,934	2,934	461	1,028	2,745	3,673	4,402	4,402	4,402
	Deflection L/240	*	*	*	*	*	*	*	*	*	*
	Min. End/Int. Bearing (in.)	4.5/11.3	4.5/11.3	4.5/11.3	1.5/3.5	1.5/3.5	2.8/7	3.8/9.4	4.5/11.3	4.5/11.3	4.5/11.3
9'-6"	Total Load	2,425	2,468	2,468	231	524	1,942	2,948	3,637	3,702	3,702
	Deflection L/240	*	*	*	*	*	1,757	*	*	*	*
	Min. End/Int. Bearing (in.)	4.4/11	4.5/11.3	4.5/11.3	1.5/3.5	1.5/3.5	2.4/5.9	3.6/8.9	4.4/11	4.5/11.3	4.5/11.3
10'	Total Load	2,275	2,344	2,344	187	427	1,751	2,659	3,412	3,516	3,516
	Deflection L/240	*	*	*	*	*	1,520	*	*	*	*
	Min. End/Int. Bearing (in.)	4.4/10.9	4.5/11.3	4.5/11.3	1.5/3.5	1.5/3.5	2.2/5.6	3.4/8.5	4.4/10.9	4.5/11.3	4.5/11.3
12'	Total Load	1,670	1,950	1,950	86	203	1,191	1,841	2,505	2,925	2,925
	Deflection L/240	*	*	*	*	*	904	1,706	*	*	*
	Min. End/Int. Bearing (in.)	3.9/9.6	4.5/11.3	4.5/11.3	1.5/3.5	1.5/3.5	1.8/4.6	2.8/7.1	3.9/9.6	4.5/11.3	4.5/11.3
14'	Total Load	1,223	1,571	1,669		106	757	1,347	1,835	2,356	2,503
	Deflection L/240	1,171	*	*		*	579	1,102	1,757	*	*
	Min. End/Int. Bearing (in.)	3.3/8.3	4.2/10.6	4.5/11.3		1.5/3.5	1.5/3.5	2.4/6.1	3.3/8.3	4.2/10.6	4.5/11.3
16'-6"	Total Load	876	1,126	1,405			463	897	1,315	1,689	2,107
	Deflection L/240	735	1,074	*			358	686	1,103	1,611	*
	Min. End/Int. Bearing (in.)	2.8/7	3.6/9	4.5/11.2			1.5/3.5	1.9/4.8	2.8/7	3.6/9	4.5/11.2
18'-6"	Total Load	691	892	1,113			326	638	1,037	1,339	1,670
	Deflection L/240	529	776	1,084			256	492	794	1,164	1,626
	Min. End/Int. Bearing (in.)	2.5/6.2	3.2/8	4/10			1.5/3.5	1.5/3.9	2.5/6.2	3.2/8	4/10
20'	Total Load	549	761	950			256	504	823	1,142	1,425
	Deflection L/240	422	621	869			203	392	633	931	1,304
	Min. End/Int. Bearing (in.)	2.1/5.4	3/7.4	3.7/9.2			1.5/3.5	1.5/3.5	2.1/5.4	3/7.4	3.7/9.2
22'	Total Load	412	613	782			190	377	619	919	1,173
	Deflection L/240	320	472	662			153	296	480	708	994
	Min. End/Int. Bearing (in.)	1.8/4.5	2.6/6.6	3.4/8.4			1.5/3.5	1.5/3.5	1.8/4.5	2.6/6.6	3.4/8.4
24'	Total Load	316	472	654			143	287	475	708	981
	Deflection L/240	248	366	515			118	229	372	550	773
	Min. End/Int. Bearing (in.)	1.5/3.8	2.2/5.6	3.1/7.7			1.5/3.5	1.5/3.5	1.5/3.8	2.2/5.6	3.1/7.7
26'	Total Load	247	370	527			110	223	371	556	790
	Deflection L/240	196	290	409			93	181	294	435	613
	Min. End/Int. Bearing (in.)	1.5/3.5	1.9/4.8	2.7/6.8			1.5/3.5	1.5/3.5	1.5/3.5	1.9/4.8	2.7/6.8
28'	Total Load	196	295	421			85	175	294	442	632
	Deflection L/240	157	233	329			75	145	236	350	494
	Min. End/Int. Bearing (in.)	1.5/3.5	1.7/4.2	2.3/5.9			1.5/3.5	1.5/3.5	1.5/3.5	1.7/4.2	2.3/5.9
30'	Total Load	157	238	341			66	139	236	357	511
	Deflection L/240	128	190	269			61	118	193	286	404
	Min. End/Int. Bearing (in.)	1.5/3.5	1.5/3.6	2.1/5.1			1.5/3.5	1.5/3.5	1.5/3.5	1.5/3.6	2.1/5.1

* Indicates Total Load value controls.

NON-SNOW ROOF LOAD TABLES

How to Use This Table

1. Calculate total load (neglect beam weight) on the beam or header in pounds per linear foot (plf).
2. Select appropriate **Span** (center-to-center of bearing).
3. Scan horizontally to find the proper width, and a depth with a capacity that exceeds actual total load.
4. Review bearing length requirements to ensure adequacy.

Also see **General Notes** on page 23.

2.2E Parallam® PSL: Roof—Non-Snow Load Area 125% (PLF)

Span	Condition	3½" Width						5¼" Width							
		9¼"	9½"	11¼"	11⅞"	14"	16"	18"	9¼"	9½"	11¼"	11⅞"	14"	16"	18"
8'	Total Load	1,839	1,899	2,330	2,441	2,441	2,441	2,441	2,759	2,848	3,495	3,661	3,661	3,661	3,661
	Deflection L/240	*	*	*	*	*	*	*	*	*	*	*	*	*	*
	Min. End/Int. Bearing (in.)	3.4/8.5	3.5/8.7	4.3/10.7	4.5/11.3	4.5/11.3	4.5/11.3	4.5/11.3	3.4/8.5	3.5/8.7	4.3/10.7	4.5/11.3	4.5/11.3	4.5/11.3	4.5/11.3
9'-6"	Total Load	1,365	1,436	1,890	2,017	2,052	2,052	2,052	2,048	2,154	2,836	3,025	3,079	3,079	3,079
	Deflection L/240	1,195	1,288	*	*	*	*	*	1,793	1,932	*	*	*	*	*
	Min. End/Int. Bearing (in.)	3/7.5	3.1/7.9	4.1/10.3	4.4/11	4.5/11.3	4.5/11.3	4.5/11.3	3/7.5	3.1/7.9	4.1/10.3	4.4/11	4.5/11.3	4.5/11.3	4.5/11.3
10'	Total Load	1,231	1,295	1,778	1,896	1,949	1,949	1,949	1,847	1,942	2,668	2,844	2,923	2,923	2,923
	Deflection L/240	1,034	1,115	*	*	*	*	*	1,551	1,672	*	*	*	*	*
	Min. End/Int. Bearing (in.)	2.8/7.1	3/7.5	4.1/10.2	4.4/10.9	4.5/11.3	4.5/11.3	4.5/11.3	2.8/7.1	3/7.5	4.1/10.2	4.4/10.9	4.5/11.3	4.5/11.3	4.5/11.3
12'	Total Load	808	873	1,235	1,369	1,620	1,620	1,620	1,213	1,310	1,853	2,053	2,431	2,431	2,431
	Deflection L/240	614	663	1,074	1,251	*	*	*	921	994	1,611	1,876	*	*	*
	Min. End/Int. Bearing (in.)	2.2/5.6	2.4/6.1	3.4/8.6	3.8/9.5	4.5/11.3	4.5/11.3	4.5/11.3	2.2/5.6	2.4/6.1	3.4/8.6	3.8/9.5	4.5/11.3	4.5/11.3	4.5/11.3
14'	Total Load	513	555	904	1,002	1,370	1,386	1,386	770	833	1,356	1,503	2,055	2,079	2,079
	Deflection L/240	392	424	692	808	1,288	*	*	589	637	1,038	1,212	1,932	*	*
	Min. End/Int. Bearing (in.)	1.7/4.2	1.8/4.5	2.9/7.3	3.2/8.1	4.4/11.1	4.5/11.3	4.5/11.3	1.7/4.2	1.8/4.5	2.9/7.3	3.2/8.1	4.4/11.1	4.5/11.3	4.5/11.3
16'-6"	Total Load	313	340	561	658	982	1,173	1,173	470	510	842	987	1,473	1,760	1,760
	Deflection L/240	243	262	430	503	808	*	*	364	394	645	755	1,213	*	*
	Min. End/Int. Bearing (in.)	1.5/3.5	1.5/3.5	2.2/5.4	2.5/6.3	3.8/9.4	4.5/11.3	4.5/11.3	1.5/3.5	1.5/3.5	2.2/5.4	2.5/6.3	3.8/9.4	4.5/11.3	4.5/11.3
18'-6"	Total Load	221	240	399	468	761	1,003	1,044	332	360	598	703	1,141	1,505	1,566
	Deflection L/240	173	187	308	361	582	854	*	260	281	462	541	873	1,281	*
	Min. End/Int. Bearing (in.)	1.5/3.5	1.5/3.5	1.7/4.3	2/5.1	3.3/8.2	4.3/10.8	4.5/11.3	1.5/3.5	1.5/3.5	1.7/4.3	2/5.1	3.3/8.2	4.3/10.8	4.5/11.3
20'	Total Load	173	188	315	370	604	856	964	260	282	472	555	906	1,284	1,447
	Deflection L/240	137	149	245	287	464	683	956	206	223	368	431	697	1,025	1,435
	Min. End/Int. Bearing (in.)	1.5/3.5	1.5/3.5	1.5/3.7	1.8/4.4	2.8/7.1	4/10	4.5/11.3	1.5/3.5	1.5/3.5	1.5/3.7	1.8/4.4	2.8/7.1	4/10	4.5/11.3
22'	Total Load	128	139	235	276	454	674	875	192	209	352	415	681	1,012	1,312
	Deflection L/240	104	112	185	217	352	519	728	156	168	278	326	528	778	1,093
	Min. End/Int. Bearing (in.)	1.5/3.5	1.5/3.5	1.5/3.5	1.5/3.6	2.4/5.9	3.5/8.7	4.5/11.3	1.5/3.5	1.5/3.5	1.5/3.5	1.5/3.6	2.4/5.9	3.5/8.7	4.5/11.3
24'	Total Load	97	105	179	211	348	520	736	145	158	268	317	523	780	1,105
	Deflection L/240	80	86	143	168	273	403	567	120	130	215	252	409	605	851
	Min. End/Int. Bearing (in.)	1.5/3.5	1.5/3.5	1.5/3.5	1.5/3.5	2/5	3/7.4	4.2/10.4	1.5/3.5	1.5/3.5	1.5/3.5	1.5/3.5	2/5	3/7.4	4.2/10.4
26'	Total Load	74	81	138	164	272	408	580	111	121	208	246	408	612	870
	Deflection L/240	63	68	113	132	215	319	450	95	102	169	199	323	479	675
	Min. End/Int. Bearing (in.)	1.5/3.5	1.5/3.5	1.5/3.5	1.5/3.5	1.7/4.3	2.5/6.3	3.6/8.9	1.5/3.5	1.5/3.5	1.5/3.5	1.5/3.5	1.7/4.3	2.5/6.3	3.6/8.9
28'	Total Load	57	62	108	129	216	325	464	86	94	163	193	324	487	696
	Deflection L/240	50	55	90	106	173	257	362	76	82	136	160	260	385	544
	Min. End/Int. Bearing (in.)	1.5/3.5	1.5/3.5	1.5/3.5	1.5/3.5	1.5/3.7	2.2/5.5	3.1/7.7	1.5/3.5	1.5/3.5	1.5/3.5	1.5/3.5	1.5/3.7	2.2/5.5	3.1/7.7
30'	Total Load			86	102	173	262	375	67	74	129	154	260	393	563
	Deflection L/240			74	86	141	209	296	62	67	111	130	212	314	444
	Min. End/Int. Bearing (in.)			1.5/3.5	1.5/3.5	1.5/3.5	1.9/4.8	2.7/6.8	1.5/3.5	1.5/3.5	1.5/3.5	1.5/3.5	1.5/3.5	1.9/4.8	2.7/6.8
32'	Total Load			69	82	140	213	307	53	58	103	124	211	320	461
	Deflection L/240			61	71	117	173	245	51	55	91	107	175	260	368
	Min. End/Int. Bearing (in.)			1.5/3.5	1.5/3.5	1.5/3.5	1.7/4.2	2.4/6	1.5/3.5	1.5/3.5	1.5/3.5	1.5/3.5	1.5/3.5	1.7/4.2	2.4/6

* Indicates Total Load value controls.

NON-SNOW ROOF LOAD TABLES

General Notes

- Table is based on:
 - Uniform loads (beam weight considered).
 - More restrictive of simple or continuous span.
 - Deflection criteria of L/180 total load.
- For stiffer deflection criteria, use **L/240** values for total load deflection.
- For continuous spans, ratio of short span to long span should be 0.4 or greater to prevent uplift.

Also see *How to Use This Table* on page 22 and *General Assumptions* on page 5.

2.2E Parallam® PSL: Roof—Non-Snow Load Area 125% (PLF) *continued*

Span	Condition	7" Width						
		9¼"	9½"	11¼"	11⅞"	14"	16"	18"
8'	Total Load	3,679	3,798	4,660	4,882	4,882	4,882	4,882
	Deflection L/240	*	*	*	*	*	*	*
	Min. End/Int. Bearing (in.)	3.4/8.5	3.5/8.7	4.3/10.7	4.5/11.3	4.5/11.3	4.5/11.3	4.5/11.3
9'-6"	Total Load	2,731	2,872	3,781	4,034	4,105	4,105	4,105
	Deflection L/240	2,390	2,576	*	*	*	*	*
	Min. End/Int. Bearing (in.)	3/7.5	3.1/7.9	4.1/10.3	4.4/11	4.5/11.3	4.5/11.3	4.5/11.3
10'	Total Load	2,462	2,590	3,557	3,792	3,898	3,898	3,898
	Deflection L/240	2,068	2,230	*	*	*	*	*
	Min. End/Int. Bearing (in.)	2.8/7.1	3/7.5	4.1/10.2	4.4/10.9	4.5/11.3	4.5/11.3	4.5/11.3
12'	Total Load	1,617	1,747	2,471	2,738	3,241	3,241	3,241
	Deflection L/240	1,228	1,326	2,148	2,502	*	*	*
	Min. End/Int. Bearing (in.)	2.2/5.6	2.4/6.1	3.4/8.6	3.8/9.5	4.5/11.3	4.5/11.3	4.5/11.3
14'	Total Load	1,027	1,111	1,809	2,004	2,740	2,773	2,773
	Deflection L/240	785	849	1,384	1,616	2,576	*	*
	Min. End/Int. Bearing (in.)	1.7/4.2	1.8/4.5	2.9/7.3	3.2/8.1	4.4/11.1	4.5/11.3	4.5/11.3
16'-6"	Total Load	627	680	1,123	1,317	1,964	2,346	2,346
	Deflection L/240	486	525	861	1,007	1,617	*	*
	Min. End/Int. Bearing (in.)	1.5/3.5	1.5/3.5	2.2/5.4	2.5/6.3	3.8/9.4	4.5/11.3	4.5/11.3
18'-6"	Total Load	442	480	798	937	1,522	2,007	2,089
	Deflection L/240	347	375	616	722	1,164	1,708	*
	Min. End/Int. Bearing (in.)	1.5/3.5	1.5/3.5	1.7/4.3	2/5.1	3.3/8.2	4.3/10.8	4.5/11.3
20'	Total Load	347	377	630	741	1,208	1,712	1,929
	Deflection L/240	275	298	490	575	929	1,366	1,913
	Min. End/Int. Bearing (in.)	1.5/3.5	1.5/3.5	1.5/3.7	1.8/4.4	2.8/7.1	4/10	4.5/11.3
22'	Total Load	257	279	470	553	908	1,349	1,750
	Deflection L/240	208	225	370	434	704	1,038	1,457
	Min. End/Int. Bearing (in.)	1.5/3.5	1.5/3.5	1.5/3.5	1.5/3.6	2.4/5.9	3.5/8.7	4.5/11.3
24'	Total Load	194	211	358	422	697	1,040	1,473
	Deflection L/240	160	173	287	336	546	806	1,135
	Min. End/Int. Bearing (in.)	1.5/3.5	1.5/3.5	1.5/3.5	1.5/3.5	2/5	3/7.4	4.2/10.4
26'	Total Load	148	162	277	328	545	816	1,160
	Deflection L/240	126	137	226	265	431	638	900
	Min. End/Int. Bearing (in.)	1.5/3.5	1.5/3.5	1.5/3.5	1.5/3.5	1.7/4.3	2.5/6.3	3.6/8.9
28'	Total Load	115	125	217	258	432	650	928
	Deflection L/240	101	110	181	213	347	514	725
	Min. End/Int. Bearing (in.)	1.5/3.5	1.5/3.5	1.5/3.5	1.5/3.5	1.5/3.7	2.2/5.5	3.1/7.7
30'	Total Load	90	98	172	205	347	524	751
	Deflection L/240	82	89	148	173	283	419	593
	Min. End/Int. Bearing (in.)	1.5/3.5	1.5/3.5	1.5/3.5	1.5/3.5	1.5/3.5	1.9/4.8	2.7/6.8
32'	Total Load	70	77	138	165	281	427	615
	Deflection L/240	68	73	122	143	234	347	490
	Min. End/Int. Bearing (in.)	1.5/3.5	1.5/3.5	1.5/3.5	1.5/3.5	1.5/3.5	1.7/4.2	2.4/6

* Indicates Total Load value controls.

BEAM DETAILS

Bearing at Wall

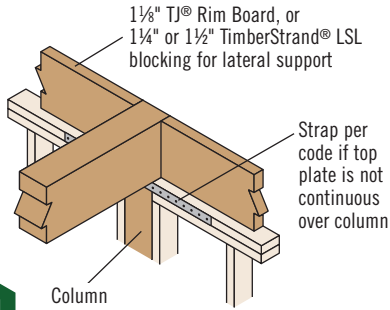

L1

Bearing for Door or Window Header

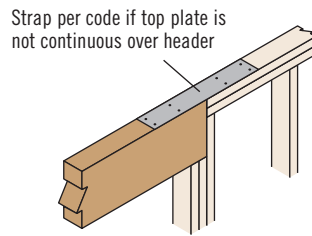

L2

Beam to Beam Connection

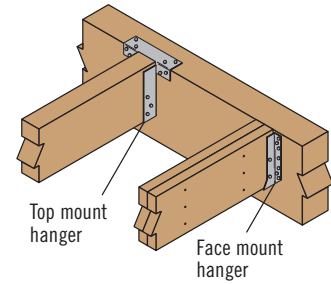

L3

Bearing at Concrete Wall

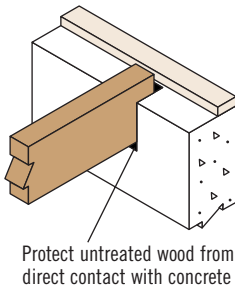

L4

Bearing at Column

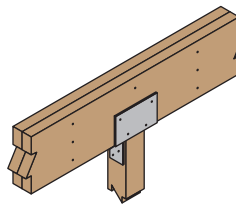

L5

Verify beam bearing length on page 26 and column capacity on page 30

Beam to Column Lateral Brace

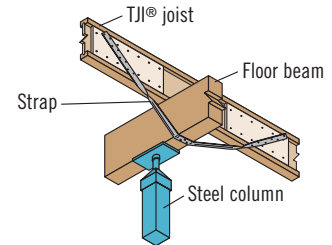

L14

Suggested lateral bracing detail for beams when required. Verify beam bearing length on page 26.

WINDOW AND DOOR HEADER DETAILS

2x4 Wall Framing

Full Depth Header

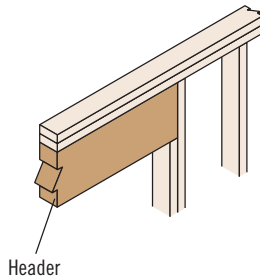

L7

Low Header

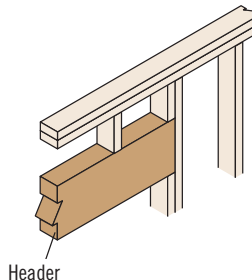

L8

High Header

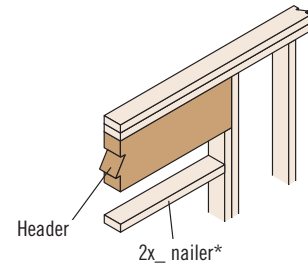

L9

*Double nailer may be required depending upon the opening size and window type

2x6 Wall Framing

Headers not matching wall thickness may be installed flush to the inside or outside of the wall, depending upon sheathing and trim attachment requirements

Plank Orientation Header

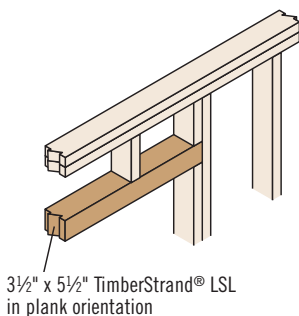

L10

Low Header

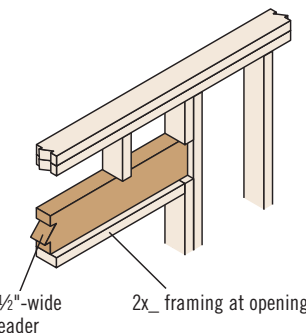

L11

High Header

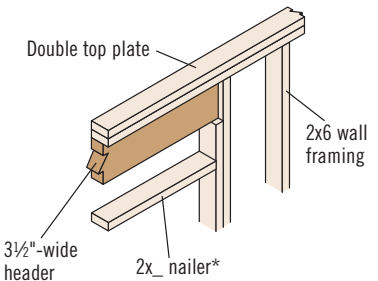

L12

*Double nailer may be required depending upon the opening size and window type

WINDOW AND DOOR HEADER DETAILS

Dropped Header with Full Lateral Bracing

One 8d (0.113" x 2½") nail each side of joist or blocking. Blocking is required if joist framing is parallel to beam. Joist spacing must be 24" on-center or less.

Nail continuous king studs to the end of the beam using:
 – Four (0.131" x 3") nails for beams 11⅞" deep or less
 – Six (0.131" x 3") nails for beams 18" deep or less

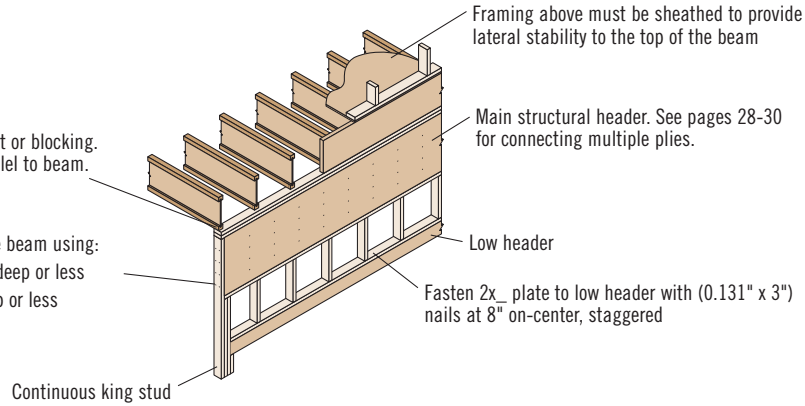

L15

Dropped Header with Acceptable Lateral Bracing

One 8d (0.113" x 2½") nail each side of joist or blocking. Blocking is required if joist framing is parallel to beam. Joist spacing must be 24" on-center or less.

Nail continuous king studs to the end of the beam using:
 – Four (0.131" x 3") nails for beams 11⅞" deep or less
 – Six (0.131" x 3") nails for beams 16" deep or less

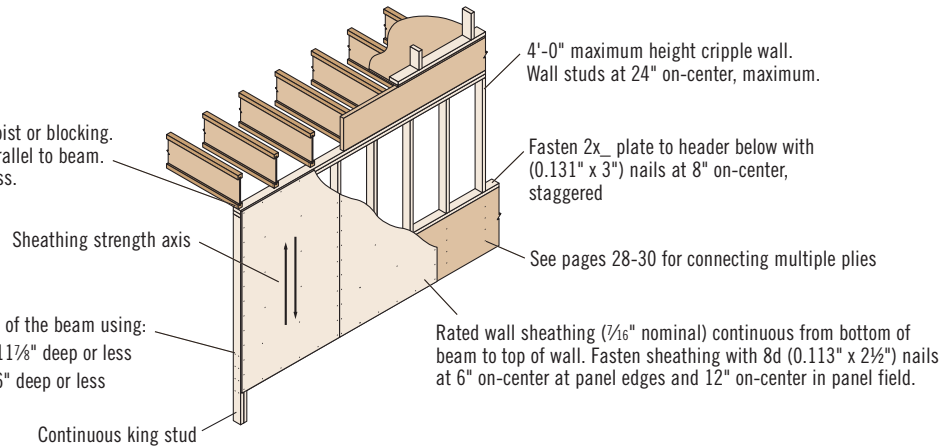

L16

When framed as shown above, the following dropped headers are considered fully braced under uniform-load, simple-span conditions:

Single-ply:

- 1¾" wide headers, 11⅞" deep or less
- 3½" wide headers, 16" deep or less, with a maximum span of 18'-6"

Multiple-ply:

- Headers up to four 1¾" plies, 11⅞" deep or less
- Headers up to four 1¾" x 14" plies, with a maximum span of 8'-6"

NAILING ON NARROW FACE

Nails Installed on the Narrow Face

Nail Size	Closest On-Center Spacing Per Row		
	TimberStrand® LSL	Microllam® LVL	Parallam® PSL
8d (0.113" x 2½"), 8d (0.131" x 2½") or 10d (0.128" x 3")	3"	4"	4"
10d (0.148" x 3") or 12d (0.148" x 3¼")	3"	5"	4"
16d (0.162" x 3½")	6" ⁽¹⁾	8" ⁽²⁾	6"
(0.131" x 3"-3½")	3"	4"	4"

Fastener spacing not applicable for shear wall applications. See ICC-ES ESR-1387 report for grade specific TimberStrand® LSL shear wall nailing requirements.

(1) Can be reduced to 3½" on-center if nail penetration into the narrow edge is no more than 1¼" (to minimize splitting).

(2) Can be reduced to 5" on-center if nail penetration into the narrow edge is no more than 1¼" (to minimize splitting).

▪ To minimize splitting, member edge distance and spacing between rows shall be 2.5 x nail diameter or ¾", whichever is greater. Where multiple rows are used, fasteners in adjacent rows must be staggered and the rows must be equally spaced from the centerline of the narrow face axis.

ALLOWABLE HOLES

1.55E TimberStrand® LSL Headers and Beams

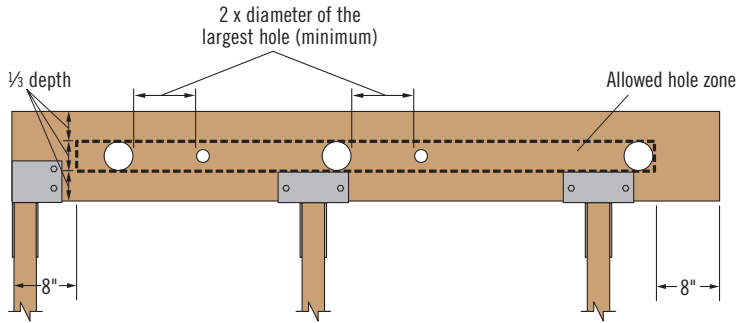

Other Trus Joist® Headers and Beams

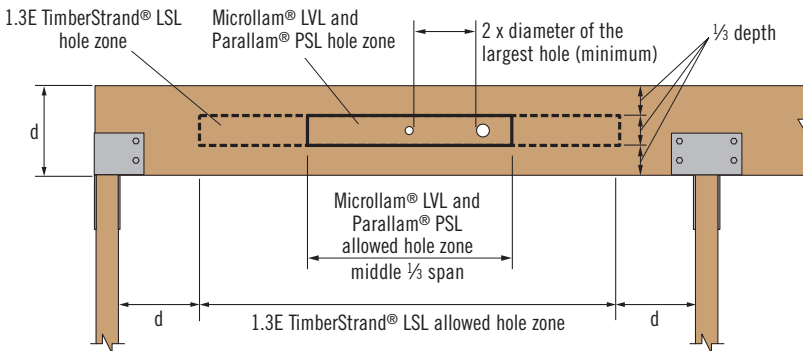

General Notes

- Allowed hole zone suitable for headers and beams with **uniform and/or concentrated loads** anywhere along the member.
- Round holes only.
- No holes in headers or beams in plank orientation.

1.55E TimberStrand® LSL

Header or Beam Depth	Maximum Round Hole Size
9½"	3"
11⅞"	3⅝"
14"-16"	4⅝"

- See illustration for allowed hole zone.

General Notes

- Allowed hole zone suitable for headers and beams with **uniform loads only**.
- Round holes only.
- No holes in cantilevers.
- No holes in headers or beams in plank orientation.

Other Trus Joist® Beams

Header or Beam Depth	Maximum Round Hole Size
4⅜"	1"
5½"	1⅜"
7¼"-18"	2"

- See illustration for allowed hole zone.



WARNING: This product can expose you to chemicals including wood dust which are known to the State of California to cause cancer, and methanol, which are known to the State of California to cause birth defects or other reproductive harm. Drilling, sawing, sanding or machining wood products can expose you to wood dust. Avoid inhaling wood dust or use a dust mask or other safeguards for personal protection. For more information go to www.P65Warnings.ca.gov and www.P65Warnings.ca.gov/wood.

Safety data sheets for all Weyerhaeuser wood products can be found on our website at: weyerhaeuser.com/sustainability/environment/product-stewardship/safety-data-sheets.

Larger holes in Trus Joist® structural composite lumber may be possible; refer to ForteWEB® or Javelin® software.

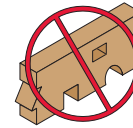

DO NOT cut, notch, or drill holes in headers or beams except as indicated in the illustrations and tables

BEARING LENGTH REQUIREMENTS

Reaction (lbs)	1.3E TimberStrand® LSL		1.55E TimberStrand® LSL			2.0E Microllam® LVL			2.2E Parallam® PSL		
	Beam Orientation	Plank Orientation	Beam Orientation			Beam Orientation			Beam Orientation		
	Width	Width	Width			Width			Width		
	3½"	5½"	1¼"	3½"	5¼"	1¾"	3½"	5¼"	3½"	5¼"	7"
2,000	1½"	1½"	1½"	1½"	1½"	1¾"	1½"	1½"	1½"	1½"	1½"
4,000	1¾"	1½"	2¾"	1½"	1½"	3¼"	1¾"	1½"	2"	1½"	1½"
6,000	2½"	1¾"	4"	2"	1½"	4¾"	2½"	1¾"	2¾"	2"	1½"
8,000	3¼"	2¼"	5¼"	2¾"	1¾"	6¼"	3¼"	2¼"	3¾"	2½"	2"
10,000	4¼"	2¾"	6½"	3¼"	2¼"	7¾"	4"	2¾"	4¾"	3¼"	2½"
12,000	5"	3½"	7¾"	4"	2¾"		4¾"	3¼"	5½"	3¾"	2¾"
14,000	5¾"	4"		4½"	3"		5½"	3¾"	6½"	4½"	3¼"
16,000	6½"	4½"		5¼"	3½"		6¼"	4¼"	7½"	5"	3¾"
18,000	7¼"	5"		5¾"	4"		7"	4¾"		5½"	4¼"
20,000		5½"		6½"	4¼"		7¾"	5¼"		6¼"	4¾"
22,000		6"		7"	4¾"			5¾"		6¾"	5¼"
24,000		7¼"		7¾"	5¼"			6¼"		7½"	5½"
26,000		7¾"			5¾"			6¾"			6"
28,000					6"			7¼"			6½"
30,000					6½"			7¾"			7"

General Notes

- Minimum bearing length:** 1½" at ends, 3½" at intermediate supports.
- Bearing across full beam width is required.
- Interpolation between reaction loads is permitted for determining bearing lengths.
- Bearing lengths based on the following bearing stresses:
 - 1.3E TimberStrand® LSL: 710 psi; 670 psi for plank orientation.
 - 1.55E TimberStrand® LSL: 900 psi.
 - 2.0E Microllam® LVL: 750 psi.
 - 2.2E Parallam® PSL: 625 psi.

TAPERED END CUTS

Allowable Reactions for 3 1/2" (1) TimberStrand® LSL Headers and Beams (lbs)

Bearing	Beam Depth	Outside Heel Height D ₁							
		4 1/2"	5"	5 1/2"	6"	6 1/2"	7"	7 1/2"	8"
3 1/2" Wood Plate ⁽²⁾	7 1/4"	5,205	5,205	5,205	5,205				
	9 1/2"	4,860	5,205	5,205	5,205	5,205	5,205	5,205	5,205
	11 7/8"	4,860	5,205	5,205	5,205	5,205	5,205	5,205	5,205
	14"		5,205	5,205	5,205	5,205	5,205	5,205	5,205
5 1/4" Wood Plate ⁽²⁾	7 1/4"	7,190	7,190	7,190					
	9 1/2"	5,255	5,710	6,160	6,610	6,870	6,870	6,870	6,870
	11 7/8"	5,255	5,710	6,160	6,610	7,065	7,515	7,810	7,810
	14"	5,255	5,710	6,160	6,610	7,065	7,515	7,810	7,810
	16"			6,160	6,610	7,065	7,515	7,810	7,810
3 1/2" Column ⁽³⁾	7 1/4"	6,665	7,190	7,190	7,190				
	9 1/2"	4,860	5,310	5,765	6,215	6,670	6,870	6,870	6,870
	11 7/8"	4,860	5,310	5,765	6,215	6,670	7,120	7,570	8,025
	14"		5,310	5,765	6,215	6,670	7,120	7,570	8,025
	16"				6,215	6,670	7,120	7,570	8,025

(1) For 1 3/4" and 5 1/4" beams, multiply by 0.5 and 1.5, respectively.

(2) Bearing lengths, based on F_{c⊥} of 425 psi.

(3) Bearing lengths based on F_{c⊥} of 710 psi for 1.3E TimberStrand® LSL and 900 psi for 1.55E TimberStrand® LSL.

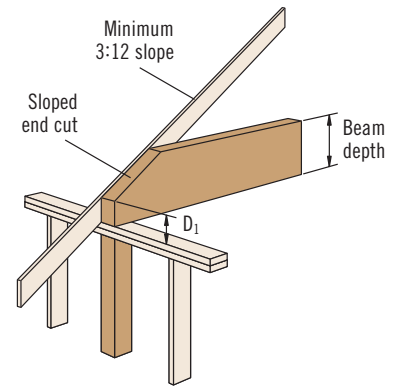

Tapered end cut detailed above is not allowed with TJI® joists

Allowable Reactions for 3 1/2" (1) Microllam® LVL and Parallam® PSL Beams (lbs)

Bearing	Beam Depth	Outside Heel Height D ₁								
		4 1/2"	5"	5 1/2"	6"	6 1/2"	7"	7 1/2"	8"	10"
3 1/2" Wood Plate ⁽²⁾	7 1/4"	4,470	4,820	4,820	4,820					
	9 1/4"	4,470	4,885	5,205	5,205	5,205	5,205	5,205	5,205	
	9 1/2"	4,470	4,885	5,205	5,205	5,205	5,205	5,205	5,205	
	11 1/4"	4,470	4,885	5,205	5,205	5,205	5,205	5,205	5,205	5,205
	11 7/8"	4,470	4,885	5,205	5,205	5,205	5,205	5,205	5,205	5,205
	14"		4,885	5,205	5,205	5,205	5,205	5,205	5,205	5,205
	16"				5,205	5,205	5,205	5,205	5,205	5,205
5 1/4" Wood Plate ⁽²⁾	7 1/4"	4,820	4,820	4,820						
	9 1/4"	4,830	5,245	5,665	6,080	6,150	6,150	6,150		
	9 1/2"	4,830	5,245	5,665	6,080	6,320	6,320	6,320	6,320	
	11 1/4"	4,830	5,245	5,665	6,080	6,495	6,910	7,325	7,480	
	11 7/8"	4,830	5,245	5,665	6,080	6,495	6,910	7,325	7,740	7,810
	14"	4,830	5,245	5,665	6,080	6,495	6,910	7,325	7,740	7,810
	16"			5,665	6,080	6,495	6,910	7,325	7,740	7,810
3 1/2" Column ⁽³⁾	7 1/4"	4,470	4,820	4,820	4,820					
	9 1/4"	4,470	4,885	5,300	5,715	6,130	6,150	6,150	6,150	
	9 1/2"	4,470	4,885	5,300	5,715	6,130	6,320	6,320	6,320	
	11 1/4"	4,470	4,885	5,300	5,715	6,130	6,545	6,960	7,375	7,480
	11 7/8"	4,470	4,885	5,300	5,715	6,130	6,545	6,960	7,375	7,655
	14"		4,885	5,300	5,715	6,130	6,545	6,960	7,375	7,655
	16"				5,715	6,130	6,545	6,960	7,375	7,655

(1) For 1 3/4", 5 1/4", and 7" beams, multiply by 0.5, 1.5, and 2.0, respectively.

(2) Bearing lengths based on F_{c⊥} of 425 psi.

(3) Bearing lengths based on F_{c⊥} of 625 psi.

Wood Plate Connection

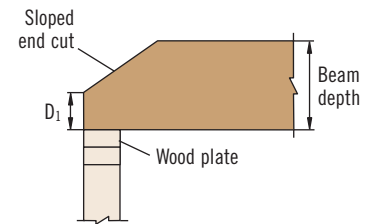

Column Connection

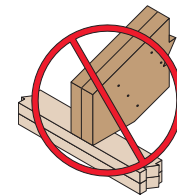
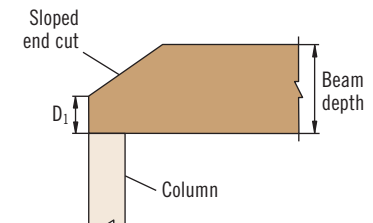

DO NOT overhang seat cuts on beams beyond inside face of support member

General Notes

- No increase for duration of load is permitted.
- No holes or concentrated load within tapered cut.
- Table considers only downward loading. Contact your Weyerhaeuser representative for assistance with uplift loading or other conditions.

MULTIPLE-MEMBER CONNECTIONS FOR SIDE-LOADED BEAMS

L17 Uniform Load—Maximum Uniform Load Applied to Either Outside Member (PLF)

Fastener Type	Placement	Number of Rows	Fastener On-Center Spacing	Fastener Pattern					
				Assembly A	Assembly B	Assembly C	Assembly D	Assembly E	Assembly F
				3 1/2" wide, 2-ply	5 1/4" wide, 3-ply	5 1/4" wide, 2-ply	7" wide, 3-ply	7" wide, 2-ply	7" wide, 4-ply
10d (0.128" x 3") or (0.131" x 3") Nail ⁽¹⁾	As shown	2 ⁽⁶⁾	12"	370	280	280	250		
		3	12"	560	420	420	370		
1/2" A307 Through Bolt ⁽²⁾⁽³⁾	—	2	24"	510	380	525	465	860	340
			19.2"	635	475	655	580	1075	425
			16"	760	570	785	700	1290	510
			Screw Length ▶	3 1/2"	3 1/2"	3 1/2"	3 1/2"	6"	6"
Simpson Strong-Tie® SDS ⁽³⁾	As shown	2	24"	680	510	510	455	1,360	555
			19.2"	850	640	640	565	1,700	695
			16"	1,020	765	765	680	2,040	835
MiTek® WS ⁽³⁾	As shown	2	24"	640	480	480	425		475⁽⁷⁾
			19.2"	800	600	600	530		595⁽⁷⁾
			16"	955	720	720	640		715⁽⁷⁾
			Screw Length ▶	3 3/8"	5"	3 3/8"	6 3/4"	6 3/4"	6 3/4"
Simpson Strong-Tie® SDW22 ⁽³⁾⁽⁴⁾	One face	2	24"	800	450	600	400	800	400
			19.2"	1,000	565	750	500	1,000	500
			16"	1,200	675	900	600	1,200	600
MiTek® WSWH ⁽³⁾⁽⁵⁾	One face	2	24"	600	430	480	380	830	380
			19.2"	750	535	600	475	1,040	475
			16"	905	645	720	575	1,245	575

(1) Nailed connection values may be doubled for 6" on-center or tripled for 4" on-center nail spacing.

(2) Washers required. Bolt holes to be 9/16" maximum. 9/4" minimum beam depth.

(3) 24" on-center bolted or screwed connection values may be doubled for 12" on-center spacing.

(4) When loading the head side of a SDW22 screw, assemblies B, D, and F can be increased by 30%.

(5) When loading the head side of a WSWH screw, assemblies B, D, and F can be increased by 25%.

(6) For beams up to 14" deep, maximum.

(7) Assembly F is not recommended for TimberStrand® LSL or Parallam® PSL.

• **Bold italic** loads indicate assemblies that require fastener placement on both faces. Stagger fasteners on the second face so they fall halfway between fasteners on the first face.

General Notes for Side-Loaded Beam Tables

- Connections are based on NDS® or manufacturer's test or code reports.
- Use specific gravity of 0.5 for design of lateral connections.
- Values listed are for 100% stress level. Increase 15% for snow-loaded roof conditions or 25% for non-snow roof conditions, where code allows.
- Minimum end distance for bolts and screws is 6".
- Verify adequacy of beam in allowable load tables on pages 6–23.
- 7" wide beams should be side-loaded only when loads are applied to both faces of the members (to minimize rotation).
- Beams wider than 7" require special consideration by the design professional of record.

Uniform Load Design Example

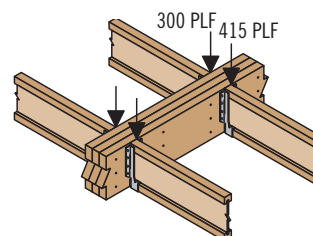



First, check allowable load tables on pages 6–23 to verify that three pieces can carry the total load of 715 plf with proper live load deflection criteria. Maximum load applied to either outside member is 415 plf. For an assembly of three 1 3/4" plies (Assembly B), two rows of (0.131" x 3") nails on both faces at 12" on-center are good for only 280 plf. Therefore, use three rows of (0.131" x 3") nails on both faces at 12" on-center (good for 420 plf).

Alternative: Two rows of 1/2" A307 bolts at 19.2" on-center or two rows of 5" SDW22 screws on one face at 24" on-center.

MULTIPLE-MEMBER CONNECTIONS FOR SIDE-LOADED BEAMS

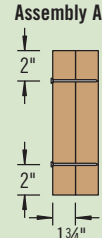
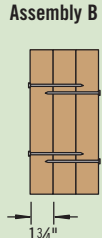
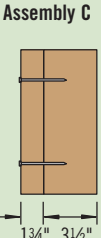
L18 Point Load—Maximum Point Load Applied to Either Outside Member (lbs)

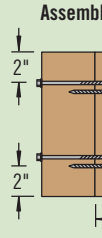
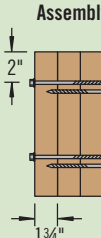
Fastener Type	Placement	Number of Fasteners per Face	Fastener Pattern					
			Assembly A 	Assembly B 	Assembly C 	Assembly D 	Assembly E 	Assembly F 
			3 1/2" wide, 2-ply	5 1/4" wide, 3-ply	5 1/4" wide, 2-ply	7" wide, 3-ply	7" wide, 2-ply	7" wide, 4-ply
10d (0.128" x 3") or (0.131" x 3") Nail	As shown	6	1,115	835	835	745		
		12	2,230	1,675	1,675	1,490		
		18	3,350	2,510	2,510	2,230		
		24	4,465	3,350	3,350	2,975		
		Screw Length ▶	3 1/2"	3 1/2"	3 1/2"	3 1/2"	6"	6"
Simpson Strong-Tie® SDS	As shown	4	2,720	2,040	2,040	1,815	5,440	2,225
		6	4,080	3,060	3,060	2,720	8,160	3,335
		8	5,440	4,080	4,080	3,625	10,880	4,450
MiTek® WS	As shown	4	2,550	1,915	1,915	1,700		1,910⁽³⁾
		6	3,830	2,870	2,870	2,550		2,865⁽³⁾
		8	5,105	3,830	3,830	3,405		3,820⁽³⁾
		Screw Length ▶	3 3/8"	5"	3 3/8"	6 3/4"	6 3/4"	6 3/4"
Simpson Strong-Tie® SDW22 ⁽¹⁾	One face	4	3,200	1,800	2,400	1,600	3,200	1,600
		6	4,800	2,700	3,600	2,400	4,800	2,400
		8	6,400	3,600	4,800	3,200	6,400	3,200
MiTek® WSWH ⁽²⁾	One face	4	2,410	1,720	1,915	1,525	3,320	1,525
		6	3,610	2,580	2,870	2,290	4,980	2,290
		8	4,815	3,435	3,830	3,055	6,640	3,055

(1) When loading the head side of a SDW22 screw, assemblies B, D, and F can be increased by 30%.

(2) When loading the head side of a WSWH screw, assemblies B, D, and F can be increased by 25%.

(3) Assembly F is not recommended for TimberStrand® LSL or Parallam® PSL.

• **Bold italic** loads indicate assemblies that require fastener placement on both faces. For screws required on both faces, refer to screw manufacturer's guidelines for minimum spacing requirements.

Point Load Design Example

First, verify that a 3-ply, 1 3/4" x 14" beam can support a 3,000 lb point load and all other loads applied. The 3,000 lb point load is being transferred to the beam with a face mount hanger. For an assembly of three 1 3/4" plies (Assembly B), six 3 1/2" SDS screws on each member face (12 total) are good for 3,060 lbs with a face mount hanger.

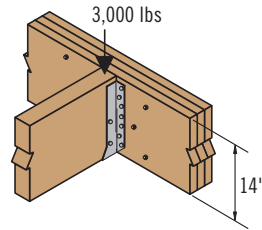

Point Load Fastener Spacing

4- or 6-Screws per Face Connection

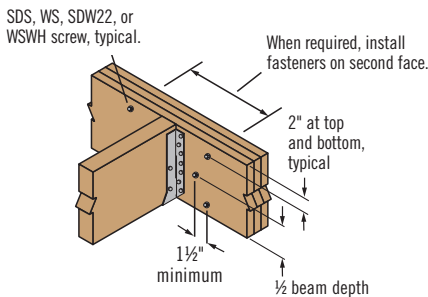

8-Screws per Face Connection

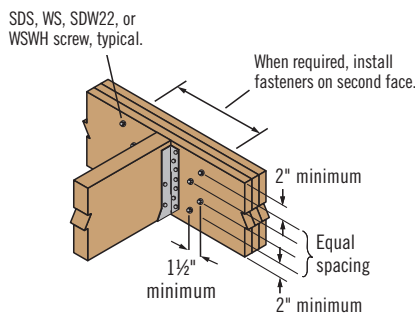

Nail Connection

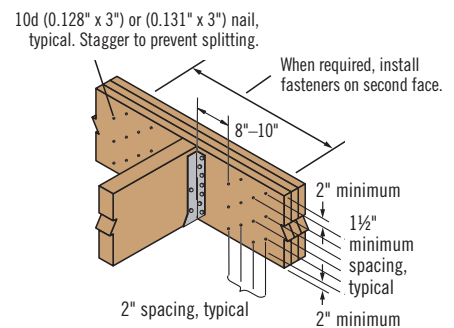

L19

L20

L21

There must be an equal number of nails on each side of the point load

See table above for placement and number of fasteners per face.

MULTIPLE-MEMBER CONNECTIONS FOR TOP-LOADED BEAMS

Fastener Installation Requirements

When fasteners are required on both faces, stagger fasteners on the second face so they fall halfway between fasteners on the first face.

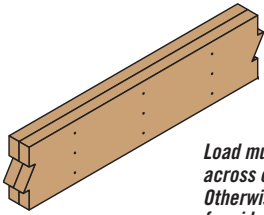

Load must be applied evenly across entire beam width. Otherwise, use connections for side-loaded beams



Multiple pieces can be nailed or bolted together to form a header or beam of the required size, up to a maximum width of 7"

Piece Width	Number of Plies	Fastener				
		Type ⁽¹⁾	Min. Length	Placement	# Rows	O.C. Spacing
1 3/4"	2	10d nails	3"	One face	3 ⁽²⁾	12"
		12d-16d nails	3 3/4"		2 ⁽²⁾	
		Screws	3 3/8" or 3 1/2"		2	
	3	10d nails	3"	Both faces	3 ⁽²⁾	12"
			12d-16d nails		3 3/4"	
		Screws	3 3/8" or 3 1/2"	Both faces	2	24"
			5"			
		1/2" bolts ⁽⁴⁾	6"	—	2	24"
	4	10d nails ⁽³⁾	3"	One face (per ply)	3 ⁽²⁾	12"
			12d-16d nails ⁽³⁾		3 3/4"	
		Screws	5" or 6"	Both faces	2	24"
			6 3/4"			
1/2" bolts ⁽⁴⁾	8"	—	2	24"		
3 1/2"	2	Screws	5" or 6"	Both faces	2	24"
			6 3/4"			
		1/2" bolts ⁽⁴⁾	8"	—	2	24"

- (1) 10d nails are 0.128"-0.131" diameter; 12d-16d nails are 0.148"-0.162" diameter; screws are SDS, WS, SDW22, or WSWH.
- (2) An additional row of nails is required with depths of 14" or greater.
- (3) When connecting 4-ply members, nail each ply to the other and offset nail rows by 2" from rows in the ply below.
- (4) Washers required. Bolt holes to be 1/16" maximum. 9/4" minimum beam depth.

COLUMNS

Allowable Axial Loads (lbs) for 1.3E TimberStrand® LSL

Column Bearing Type	Effective Column Length	Column Size											
		3 1/2" x 3 1/2"			3 1/2" x 4 3/8"			3 1/2" x 5 1/2"			3 1/2" x 7 1/4"		
		100%	115%	125%	100%	115%	125%	100%	115%	125%	100%	115%	125%
On Column Base	3'	12,155	13,655	14,610	15,195	17,070	18,260	19,100	21,455	22,955	25,180	28,285	30,260
	4'	10,735	11,820	12,480	13,420	14,775	15,600	16,870	18,575	19,610	22,240	24,485	25,850
	5'	9,115	9,805	10,205	11,395	12,255	12,755	14,320	15,405	16,035	18,880	20,310	21,140
	6'	7,545	7,980	8,230	9,430	9,975	10,290	11,855	12,540	12,935	15,630	16,530	17,050
	7'	6,230	6,525	6,690	7,790	8,155	8,365	9,790	10,250	10,515	12,910	13,510	13,860
	8'	5,190	5,395	5,515	6,485	6,745	6,895	8,155	8,480	8,665	10,750	11,175	11,420
	9'	4,370	4,520	4,610	5,465	5,650	5,760	6,870	7,105	7,240	9,055	9,365	9,545
	10'	3,720	3,835	3,900	4,655	4,795	4,875	5,850	6,030	6,130	7,710	7,945	8,080
	14'	2,785	2,855	2,890	3,480	3,565	3,615	4,375	4,485	4,545	5,765	5,910	5,990
On Wood Plate ⁽¹⁾⁽²⁾	3'-7'	5,765	5,765	5,765	7,065	7,065	7,065	8,740	8,740	8,740	10,785	10,785	10,785
	8'	5,190	5,395	5,515	6,485	6,745	6,895	8,155	8,480	8,665	10,750	10,785	10,785
	9'	4,370	4,520	4,610	5,465	5,650	5,760	6,870	7,105	7,240	9,055	9,365	9,545
	10'	3,720	3,835	3,900	4,655	4,795	4,875	5,850	6,030	6,130	7,710	7,945	8,080
	12'	2,785	2,855	2,890	3,480	3,565	3,615	4,375	4,485	4,545	5,765	5,910	5,990
	14'	2,155	2,200	2,225	2,690	2,750	2,780	3,385	3,455	3,495	4,460	4,555	4,610

- (1) Wood plate bearing is based on compression perpendicular-to-grain stress of 425 psi adjusted per the NDS®, 3.10.4.
- (2) See connection details below.

General Notes

- Tables are based on:
 - Solid, one-piece column members used in dry-service conditions.
 - Bracing in both directions at column ends.
 - NDS®.
 - Simple columns with axial loads only. For side loads or other combined bending and axial loads, see the NDS®.
- Allowable loads have been adjusted to accommodate the worst case of the following eccentric conditions: 1/6 of column thickness (first dimension) or 1/6 of column width.
- Beams and columns must remain straight to within 5L/4608 (in.) of true alignment. L is the unrestrained length of the member in feet.

For column allowable design stresses see page 5.

Allowable Axial Loads (lbs) for 1.8E Parallam® PSL

Column Bearing Type	Effective Column Length	Column Size																		
		3 1/2" x 3 1/2"			3 1/2" x 5 1/4"			3 1/2" x 7"			5 1/4" x 5 1/4"			5 1/4" x 7"			7" x 7"			
		100%	115%	125%	100%	115%	125%	100%	115%	125%	100%	115%	125%	100%	115%	125%	100%	115%	125%	
On Column Base	6'	10,595	11,200	11,545	15,890	16,800	17,320	21,190	22,395	23,095	33,295	36,675	38,735	40,000	40,000	40,000	40,000	40,000	40,000	40,000
	7'	8,735	9,140	9,370	13,105	13,710	14,060	17,475	18,280	18,745	30,010	32,545	34,030	40,000	40,000	40,000	40,000	40,000	40,000	40,000
	8'	7,265	7,550	7,715	10,900	11,325	11,570	14,535	15,100	15,425	26,650	28,490	29,555	35,530	37,985	39,410	40,000	40,000	40,000	40,000
	9'	6,115	6,320	6,440	9,170	9,480	9,660	12,225	12,640	12,880	23,475	24,835	25,620	31,300	33,115	34,165	40,000	40,000	40,000	40,000
	10'	5,200	5,355	5,445	7,800	8,035	8,170	10,400	10,715	10,895	20,660	21,695	22,290	27,545	28,925	29,725	40,000	40,000	40,000	40,000
	12'	3,885	3,980	4,030	5,825	5,965	6,050	7,765	7,955	8,065	16,160	16,805	17,175	21,545	22,405	22,900	40,000	40,000	40,000	40,000
	14'	3,000	3,065	3,100	4,500	4,595	4,645	6,005	6,125	6,195	12,890	13,315	13,560	17,185	17,755	18,080	34,155	35,785	36,725	36,725
	16'										10,480	10,775	10,950	13,970	14,370	14,595	28,485	29,640	30,300	30,300
	18'										8,670	8,885	9,010	11,560	11,850	12,015	24,020	24,860	25,345	25,345
	20'										7,285	7,445	7,535	9,710	9,925	10,050	20,475	21,110	21,475	21,475
	22'																17,630	18,125	18,405	18,405
	24'																15,325	15,715	15,935	15,935

The column and connector values listed are for dry-service conditions ONLY. When wet-service conditions exist, contact your Weyerhaeuser representative for other product solutions.

COLUMNS

Top or Bottom Plate Connection

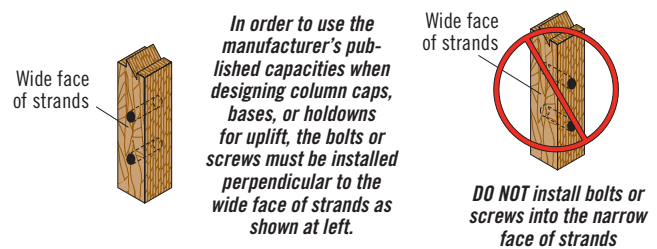
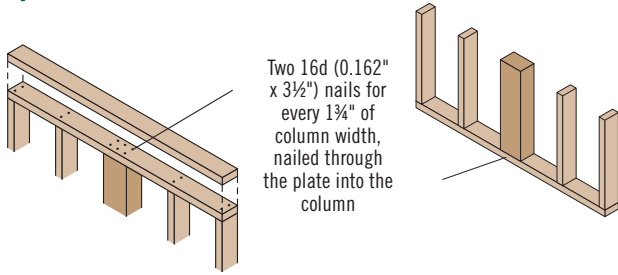

Column Caps for TimberStrand® LSL and Parallam® PSL

Column Product	Beam Width	Column Size	Location on Beam	Simpson Strong-Tie®		USP Structural Connectors®	
				Connector	Load (lbs)	Connector	Load (lbs)
1.3E TimberStrand® LSL	3½"	3½" x 3½"	End	ECC44	7,655	KECC44	12,030
			Intermediate	CC44	15,315	KCC44	15,315
		3½" x 5½"	End	ECC46	12,030	KECC46	18,595
			Intermediate	CC46	24,065	KCC46	24,065
		3½" x 7¼"	End	ECC48	16,405	KECC48	20,780
			Intermediate	CC48	24,065	KCC48	24,065
1.8E Parallam® PSL	3½"	3½" x 3½"	End	ECC44	7,655	KECC44	12,030
			Intermediate	CC44	15,315	KCC44	15,315
		3½" x 5¼"	End	ECC46	12,030	KECC45	16,405
			Intermediate	CC46	24,065	KCC45	24,065
	5¼"	5¼" x 3½"	End	ECC64	12,030	KECC64	24,610
			Intermediate	CC64	28,585	KCC64	36,095
		5¼" x 5¼"	End	ECC66	18,905	KECC66	24,610
			Intermediate	CC66	33,275	KCC66	36,095
		5¼" x 7"	End	ECC6-7½"	24,490	KECC57	31,170
			Intermediate	CC6-7½"	36,095	KCC57	36,095
	7"	7" x 3½"	End	ECC7½-4	18,375	—	—
			Intermediate	CC7½-4	34,730	—	—
		7" x 5¼"	End	ECC7½-6	28,875	KECC75X	45,940
			Intermediate	CC7½-6	38,500	KCC75X	56,875
		7" x 7"	End	ECC7½-7½"	36,750	KECC77X	45,940
			Intermediate	CC7½-7½"	56,875	KCC77X	56,875

Beam on Column Cap

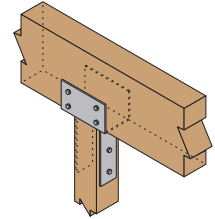

P1

Column Base

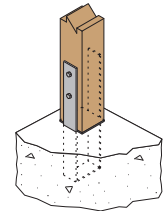

P2

Column Bases for TimberStrand® LSL and Parallam® PSL

Column Product	Column Size	Simpson Strong-Tie®		USP Structural Connectors®	
		Connector	Load (lbs)	Connector	Load (lbs)
1.3E TimberStrand® LSL	3½" x 3½"	ABA44Z	5,660	PA44	4,155
		PAU44			6,775
		CB44	Post or concrete control	CBSQ44-TZ	Post or concrete control
	3½" x 5½"	ABA46Z	10,500	PA46	4,155
		CB46	Post or concrete control	KCB46	Post or concrete control
3½" x 7¼"	CB48	Post or concrete control	KCB48	Post or concrete control	
1.8E Parallam® PSL	3½" x 3½"	CB44	Post or concrete control	CBE44	Post or concrete control
	3½" x 5¼"	CB46		KCB44	
				CBE46	
				KCB46	
	3½" x 7"	CB7½-4		KCB74	
	5¼" x 5¼"	CB66		CBE66	
				KCB66	
	5¼" x 7"	CB6-7		KCB76	
CB7½-6					
7" x 7"	CB7½-7	KCB77			

Elevated Column Base

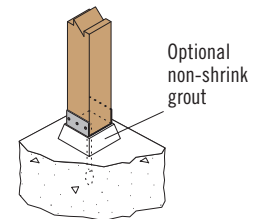

P3

Beam on Column

1½" TJ® Rim Board, or 1¼" or 1½" TimberStrand® LSL blocking for lateral support

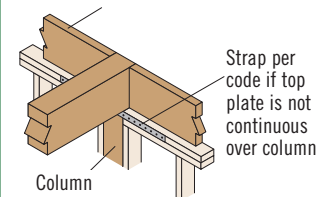

L1

General Notes

- Capacities shown cannot be adjusted for duration of load.
- Connector capacities assume a beam material with a minimum perpendicular-to-grain bearing of 625 psi.
- Connector capacities may be more than the column capacity; therefore, check both the connector and the column capacity and use the lower capacity.
- Other connectors may be available. Capacities may vary depending on orientation of member. Contact the hanger manufacturer for more information.

WE CAN HELP YOU BUILD SMARTER

You want to build solid and durable structures—we want to help. Weyerhaeuser provides high-quality building products and unparalleled technical and field assistance to support you and your project from start to finish.

Floors and Roofs: Start with the best framing components in the industry: our Trus Joist® TJI® joists; TimberStrand® LSL rim board; and TimberStrand® LSL, Microllam® LVL, and Parallam® PSL headers and beams. Pull them all together with our self-gapping and self-draining Weyerhaeuser Edge Gold™ floor panels and durable Weyerhaeuser roof sheathing.

Walls: Get the best value out of your framing package—use TimberStrand® LSL studs for tall walls, kitchens, and bathrooms, and our traditional, solid-sawn lumber everywhere else. Cut down installation time by using TimberStrand® LSL headers for doors and windows, and Weyerhaeuser wall sheathing with its handy two-way nail lines.

Software Solutions: Whether you are a design professional or lumber dealer, Weyerhaeuser offers an array of software packages to help you specify individual framing members, create cut lists, manage inventories—even help you design a complete structural frame. Contact your Weyerhaeuser representative to find out how to get the software you need.

Technical Support: Need technical help? Weyerhaeuser has one of the largest networks of engineers and sales representatives in the business. Call us for help, and a skilled member from our team of experts will answer your questions and work with you to develop solutions that meet all your structural framing needs.

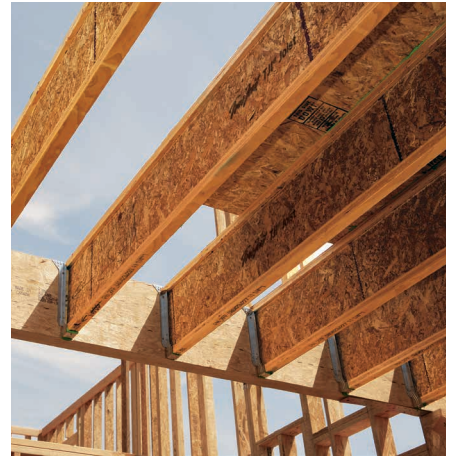

LIMITED LIFETIME PRODUCT WARRANTY

Weyerhaeuser provides limited lifetime warranties for all Trus Joist® branded products. Product information, installation instructions, and the full text of each product's limited warranty (including limitations and exclusions) are available on the Weyerhaeuser website, from your Weyerhaeuser representative, or by calling toll free: 888-453-8358.

Additionally, Weyerhaeuser offers limited warranties on a broad variety of its other products. To see complete details of all Weyerhaeuser product warranties, visit weyerhaeuser.com/woodproducts/warranty.

1.888.453.8358
WEYERHAEUSER.COM/WOODPRODUCTS

Revised 11/2022 December 2023. A, Weyerhaeuser, and Trus Joist are registered trademarks of Weyerhaeuser NR. © 2023 Weyerhaeuser NR Company. All rights reserved. California residents: For details on what personal information we collect and for what purposes, please visit weyerhaeuser.com/privacy/COCA.

1.888.453.8358 • weyerhaeuser.com/woodproducts/contact

Contact your local representative or dealer at:

Visit weyerhaeuser.com/woodproducts/warranty for copies of this and other Trus Joist® Engineered Wood Product warranties.

November 2025 • Reorder TJ-9020

This document supersedes all previous versions. If this is more than one year old, contact your dealer or Weyerhaeuser rep.

 Weyerhaeuser, Microllam, Parallam, TimberStrand, TJ, TJI, and Trus Joist are registered trademarks and Edge Gold is a trademark of Weyerhaeuser NR. © 2025 Weyerhaeuser NR Company. All rights reserved. Printed in the USA.

