



HardiePanel® Vertical Siding

MULTIFAMILY / COMMERCIAL INSTALLATION REQUIREMENTS

EFFECTIVE DECEMBER 2020

IMPORTANT: FAILURE TO FOLLOW JAMES HARDIE WRITTEN INSTALLATION INSTRUCTIONS AND COMPLY WITH APPLICABLE BUILDING CODES MAY VIOLATE LOCAL LAWS, AFFECT BUILDING ENVELOPE PERFORMANCE AND MAY AFFECT WARRANTY COVERAGE. FAILURE TO COMPLY WITH ALL HEALTH AND SAFETY REGULATIONS WHEN CUTTING AND INSTALLING THIS PRODUCT MAY RESULT IN PERSONAL INJURY. BEFORE INSTALLATION, CONFIRM YOU ARE USING THE CORRECT HARDIEZONE® PRODUCT INSTRUCTIONS BY VISITING HARDIEZONE.COM OR CALL 1-866-942-7343 (866-9-HARDIE).

STORAGE & HANDLING:

Store flat and keep dry and covered prior to installation. Installing siding wet or saturated may result in shrinkage at butt joints. Carry planks on edge. Protect edges and corners from breakage. James Hardie is not responsible for damage caused by improper storage and handling of the product.

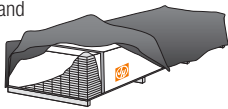

CUTTING INSTRUCTIONS

OUTDOORS

- Position cutting station so that airflow blows dust away from the user and others near the cutting area.
- Cut using one of the following methods:
 - Best:** Circular saw equipped with a HardieBlade® saw blade and attached vacuum dust collection system. Shears (manual, pneumatic or electric) may also be used, not recommended for products thicker than 7/16 in.
 - Better:** Circular saw equipped with a dust collection feature (e.g. Roan® saw) and a HardieBlade saw blade.
 - Good:** Circular saw equipped with a HardieBlade saw blade.

INDOORS

DO NOT grind or cut with a power saw indoors. Cut using shears (manual, pneumatic or electric) or the score and snap method, not recommended for products thicker than 7/16 in.

- DO NOT dry sweep dust; use wet dust suppression or vacuum to collect dust.
- For maximum dust reduction, James Hardie recommends using the "Best" cutting practices. Always follow the equipment manufacturer's instructions for proper operation.
- For best performance when cutting with a circular saw, James Hardie recommends using HardieBlade® saw blades.
- Go to jameshardiepros.com for additional cutting and dust control recommendations.

IMPORTANT: The Occupational Safety and Health Administration (OSHA) regulates workplace exposure to silica dust. For construction sites, OSHA has deemed that cutting fiber cement with a circular saw having a blade diameter less than 8 inches and connected to a commercially available dust collection system per manufacturer's instructions results in exposures below the OSHA Permissible Exposure Limit (PEL) for respirable crystalline silica, without the need for additional respiratory protection.

If you are unsure about how to comply with OSHA silica dust regulations, consult a qualified industrial hygienist or safety professional, or contact your James Hardie technical sales representative for assistance. James Hardie makes no representation or warranty that adopting a particular cutting practice will assure your compliance with OSHA rules or other applicable laws and safety requirements.

GENERAL REQUIREMENTS:

- Refer to table 1 for multifamily/commercial drainage requirements for James Hardie® vertical siding.
- HardiePanel® vertical siding can be installed over furring strips (in accordance with local building code requirements). HardiePanel vertical siding can be installed over braced wood or steel studs, 20 gauge (0.836 mm) minimum to 16 gauge (1.367 mm) maximum, spaced a maximum of 610mm (24 in) o.c
- Consult ESR1844 for fastener schedule as well as additional technical information at www.jameshardiecommercial.com.
- A water-resistive barrier is required in accordance with local building code requirements. The water-resistive barrier must be appropriately installed with penetration and junction flashing in accordance with local building code requirements. The manufacturer will assume no responsibility for water infiltration.
- Information on installing James Hardie products over non-nailable substrates (ex: gypsum, foam, etc.) can be located in JH Tech Bulletin 19 at www.jamehardie.com
- Do not install James Hardie products such that they may remain in contact with standing water.
- HardiePanel vertical siding may be installed on vertical wall applications only.
- DO NOT use HardiePanel vertical siding in Fascia or Trim applications.
- The designer and/or architect shall take into consideration the coefficient of thermal expansion and moisture movement of the product in their design. These values can be found in the Technical Bulletin #8 "Expansion Characteristics of James Hardie® Siding Products" at www.jameshardiecommercial.com.
- James Hardie Building Products provides installation /wind load information for buildings with a maximum mean roof height of 85 feet. For information on installations above 60 feet, please contact JH technical support.
- Minimum standard panel design size is 12" x 16". Note: Panels may be notched and cut to size to fit between windows, doors, corners, etc.

Table 1: HardiePanel® Vertical Siding Wall Drainage Requirements

All national, state, and local building codes must be followed, and where they are more stringent than James Hardie Installation requirements, state and local requirements will take precedence. Consult the "Exterior Wall Drainage Requirements" bulletin at www.jameshardiecommercial.com for additional guidance and a more detailed list of drainage required areas.

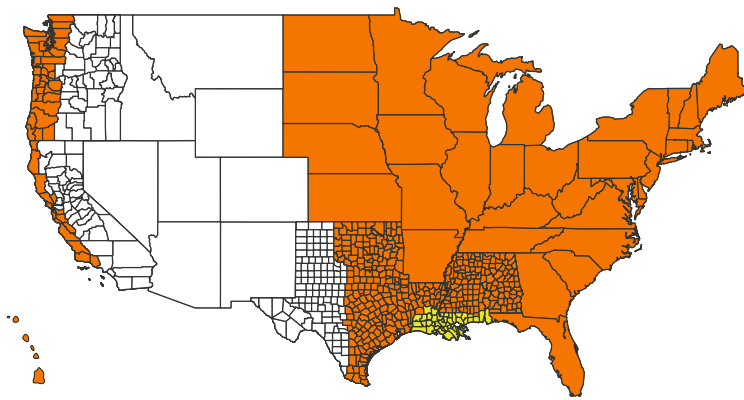

MINIMUM REQUIREMENTS BY STATE/COUNTY

A WRB¹ *Dry Climates*

B DRAINAGE PLANE (E.G. DRAINABLE WRB) WITH 90% DRAINAGE EFFICIENCY²
Moist and Marine Climates

C RAINSCREEN (MIN. 3/8 IN. AIR GAP)³
Severe Wind Driven Rain Climate

¹ Water-resistive Barrier and drainage requirements as defined by building code.

² Water-resistive Barrier as defined by local building code that is manufactured in a manner to enhance drainage; must meet minimum 90% drainage efficiency when tested in accordance with ASTM E2273 or other recognized national standards.

³ Water-resistive Barrier (WRB) as defined by building code and a minimum 3/8 in. (10mm) air space between the WRB and the panel siding (formed by minimum 3/8 in. furring).

SMOOTH | CEDARMILL® | SELECT SIERRA 8 | STUCCO



Visit jameshardiepros.com for the most recent version.

COM1220 P1/4 12/20

Table 1 cont.

A: Water Resistive Barrier Condition

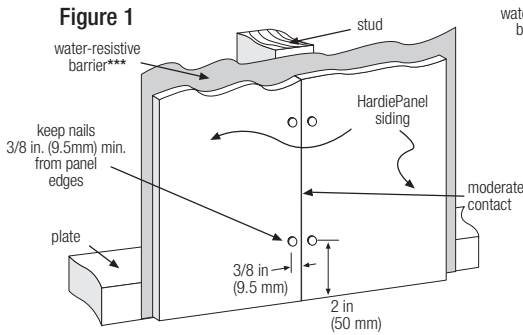

Figure 2

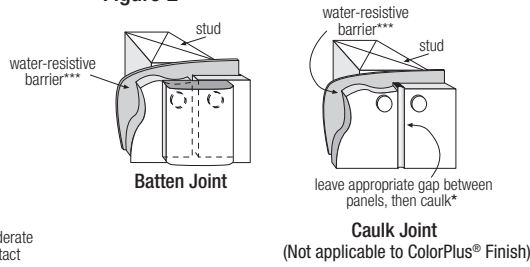

Figure 3

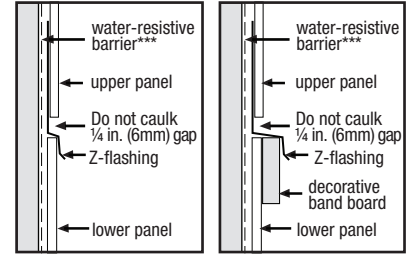
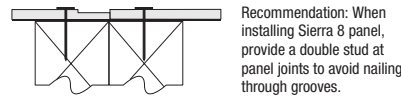

Figure 4



B: Drainage Plane/Wrap Condition

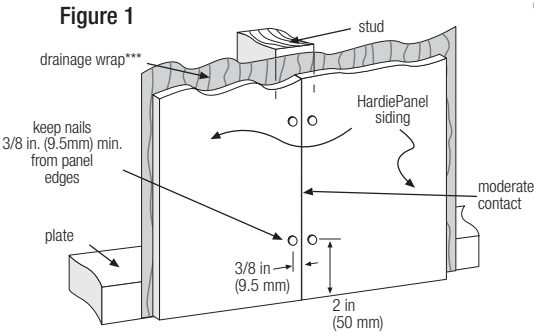

Figure 2

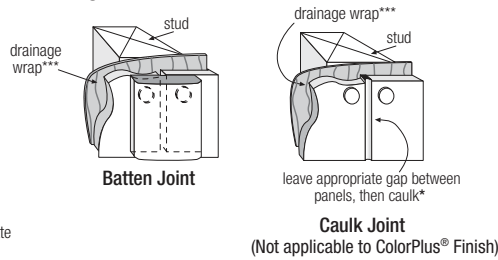

Figure 3

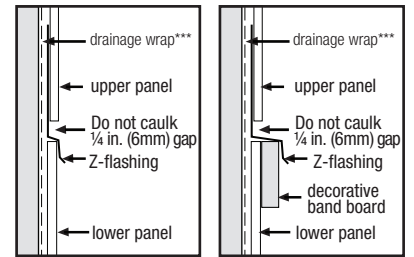
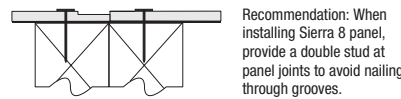

Figure 4



C: Furring/Rainscreen Condition

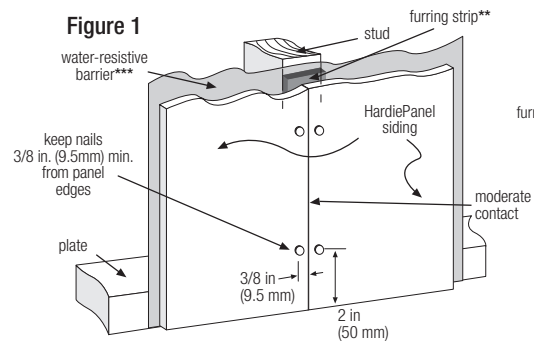

Figure 2

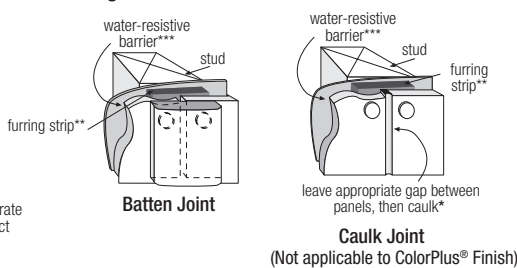

Figure 3

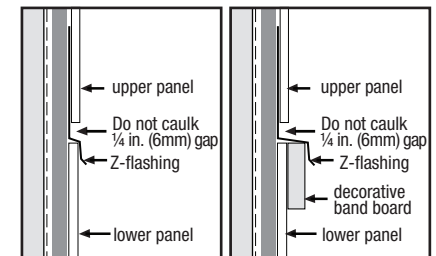
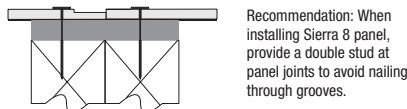

Figure 4



* Apply caulk in accordance with caulk manufacturer's written application instructions.

** Furring as prescribed in Table 1.

*** WRB or Drainage Plane as prescribed in Table 1.

INSTALLATION:

Fastener

Position fasteners 3/8 in from panel edges and no closer than 2 in away from corners. Do not nail into corners.

- HardiePanel vertical siding must be joined on stud.
- Double stud may be required to maintain minimum edge nailing distances.
- When screws are used to attach panels to steel studs/furring, the screws shall have wing tips. If screws do not have wing tips, then pre-drilling is required. (Not applicable when using pins) Follow screw chart for pre-drilling:

SCREW CHART

SCREW	PRE-DRILL	HEAD DIAMETER
No. 8	7/32 in	Min 0.323 in
No. 10	1/4 in	Min 0.323 in

Joint Treatment

- Vertical Joints - Install panels in moderate contact (fig. 1), alternatively joints may also be covered with battens, PVC or metal jointers or caulked (Not applicable to ColorPlus® Finish) (fig. 2).
- Horizontal Joints - Provide Z-flashing at all horizontal joints (fig. 3).



CLEARANCE AND FLASHING REQUIREMENTS

Figure 5
Roof to Wall

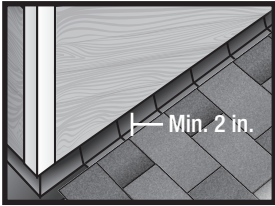

Figure 6
Horizontal Flashing

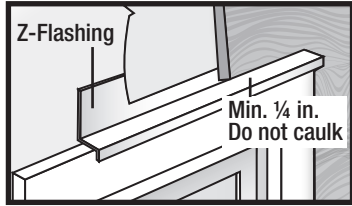

Figure 7
Kickout Flashing

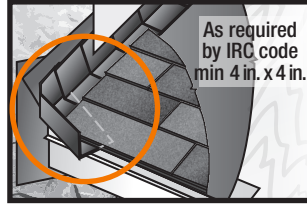

Figure 8
Slabs, Path, Steps to Siding

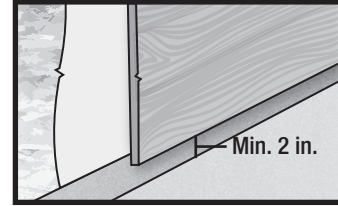

Figure 9
Deck to Wall

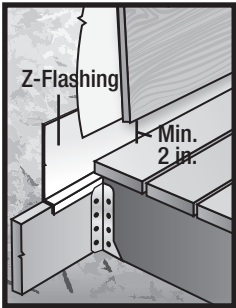

Figure 10
Ground to Siding

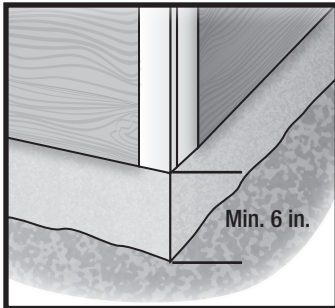

Figure 11
Gutter to Siding

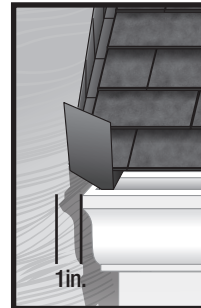

Figure 12
Sheltered Areas

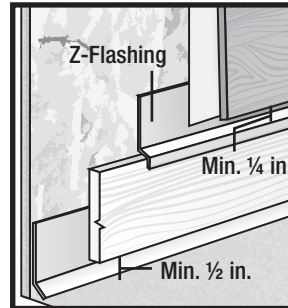

Figure 13
Mortar/Masonry

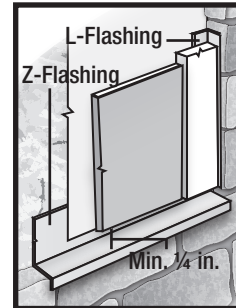

Figure 14
Drip Edge

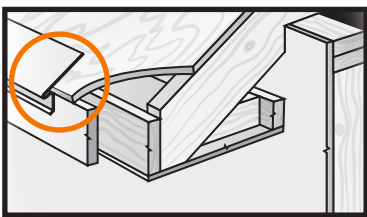

Figure 15
Block Penetration

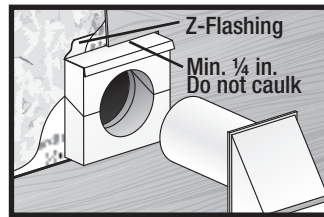
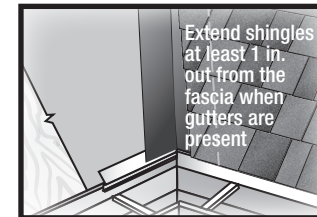
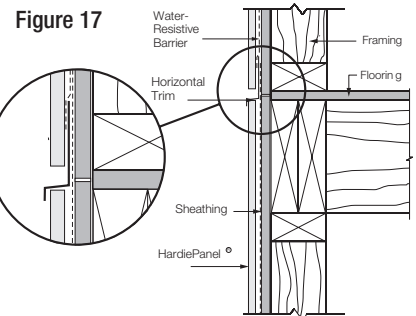

Figure 16
Valley/Shingle Extension



Do not bridge floors with HardiePanel® siding. Horizontal joints should always be created between floors, see below).



GENERAL FASTENING REQUIREMENTS

Refer to the applicable ESR report online to determine which fastener meets your wind load design criteria.

Fasteners must be corrosion resistant, galvanized, or stainless steel. Electro-galvanized are acceptable but may exhibit premature corrosion; use quality, hot-dipped galvanized nails. The manufacturer makes no warranty or representation with respect to the corrosion resistance or performance of fasteners. Stainless steel fasteners are recommended when installing James Hardie products near the ocean, large bodies of water, or in very humid climates.

Note: When utilizing express seam joints, ensure adequate nailable substrate width is available.

Manufacturers of ACQ and CA preservative-treated wood recommend spacer materials or other physical barriers to prevent direct contact of ACQ or CA preservative-treated wood and aluminum products. Fasteners used to attach HardieTrim Tabs to preservative-treated wood shall be of hot dipped zinc-coated galvanized steel or stainless steel and in accordance to 2009 IRC R317.3 or 2009 IBC 2304.9.5

- Consult applicable product evaluation or listing for correct fasteners type and placement to achieve specified design wind loads.
- NOTE: Published wind loads may not be applicable to all areas where Local Building Codes have specific jurisdiction. Consult James Hardie Technical Services if you are unsure of applicable compliance documentation.
- Drive fasteners perpendicular to siding and framing.
- Fastener heads should fit snug against siding (no air space).
- NOTE: Whenever a structural member is present, HardiePlank should be fastened with even spacing to the structural member. The tables allowing direct to OSB or plywood should only be used when traditional framing is not available.

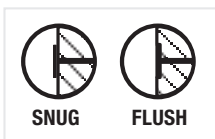

Note: Furring shown is as a best practice or as prescribed per Table 1.

DO NOT		DO NOT		DO NOT USE
UNDER DRIVE		OVER DRIVE		ALUMINUM FASTENERS
IF, THEN		IF, THEN ADDITIONAL NAIL		
WOOD FRAME	STEEL FRAME	FACE NAIL		CLIPPED HEAD NAILS
HAMMER FLUSH	REMOVE & REPLACE	COUNTERSINK & FILL		STAPLES



BLOCKED PENETRATIONS

Penetrations such as hose bibs and holes 1 ½" or larger such as dryer vents shall have a block of trim around point of penetration.

PNEUMATIC FASTENING

James Hardie products can be hand nailed or fastened with a pneumatic tool. Pneumatic fastening is highly recommended. Set air pressure so that the fastener is driven snug with the surface of the siding. A flush mount attachment on the pneumatic tool is recommended. This will help control the depth the nail is driven. If setting the nail depth proves difficult, choose a setting that under drives the nail. (Drive under driven nails snug with a smooth faced hammer; does not apply for installation to steel framing).

CUT EDGE TREATMENT

Caulk, paint or prime all field cut edges. James Hardie touch-up kits are required to touch-up ColorPlus products.

CAULKING

For best results, use an Elastomeric Joint Sealant complying with ASTM C920 Grade NS, Class 25 or higher, such as Quad® Max or a Latex Joint Sealant complying with ASTM C834. Caulking/Sealant must be applied in accordance with the caulking/sealant manufacturer's written instructions. **Note: DO NOT caulk nail heads when using ColorPlus products; refer to the ColorPlus touch-up section.**

PAINTING

DO NOT use stain on James Hardie products. James Hardie products must be painted within 180 days. 100% acrylic topcoats are recommended. Do not paint when wet. For application rates, refer to paint manufacturer's specifications. Back-rolling is recommended if a paint sprayer is used.

COLORPLUS® TECHNOLOGY CAULKING, TOUCH-UP & LAMINATE

- Care should be taken when handling and cutting James Hardie ColorPlus products.
- Laminate sheet must be removed immediately after installation of each course. Gently wipe any residue or construction dust left on the product using a soft cloth.
- Touch up nicks, scrapes and nail heads using the ColorPlus Technology touch-up applicator. Touch-up should be used sparingly. If large areas require touch-up, replace the damaged area with new HardiePanel siding with ColorPlus Technology.
- Terminate non-factory cut edges into trim where possible, and caulk. Color matched caulks are available from your ColorPlus product dealer.
- Treat all other non-factory cut edges using the ColorPlus Technology edge coat, available from your ColorPlus product dealer.

Problems with appearance or performance arising from use of third party touch-up paints or paints used as touch-up that are not James Hardie touch-up, will not be covered under the James Hardie ColorPlus Limited Finish Warranty.

Not all designs will be suitable for every application.

REPAINTING JAMES HARDIE SIDING AND TRIM PRODUCTS WITH COLORPLUS TECHNOLOGY

When repainting ColorPlus products, James Hardie recommends the following regarding surface preparation and topcoat application:

- Ensure the surface is clean, dry, and free of any dust, dirt, or mildew
- Repriming is normally not necessary
- 100% acrylic topcoats are recommended
- DO NOT use stain or oil/alkyd base paints on James Hardie products
- Apply finish coat in accordance with paint manufacturer's written instructions regarding coverage, application methods, and application temperature

COM1220 P4/4 12/20

SILICA WARNING

DANGER: May cause cancer if dust from product is inhaled. Causes damage to lungs and respiratory system through prolonged or repeated inhalation of dust from product. Refer to the current product Safety Data Sheet before use. The hazard associated with fiber cement arises from crystalline silica present in the dust generated by activities such as cutting, machining, drilling, routing, sawing, crushing, or otherwise abrading fiber cement, and when cleaning up, disposing of or moving the dust. When doing any of these activities in a manner that generates dust you must (1) comply with the OSHA standard for silica dust and/or other applicable law, (2) follow James Hardie cutting instructions to reduce or limit the release of dust; (3) warn others in the area to avoid breathing the dust; (4) when using mechanical saw or high speed cutting tools, work outdoors and use dust collection equipment; and (5) if no other dust controls are available, wear a dust mask or respirator that meets NIOSH requirements (e.g. N-95 dust mask). During clean-up, use a well maintained vacuum and filter appropriate for capturing fine (respirable) dust or use wet clean-up methods - never dry sweep.

WARNING: This product can expose you to chemicals including respirable crystalline silica, which is known to the State of California to cause cancer. For more information go to P65Warnings.ca.gov.

RECOGNITION: In accordance with ICC-ES Evaluation Report ESR-1844, HardiePanel® vertical siding is recognized as a suitable alternate to that specified in the 2006, 2009, 2012 & 2015 International Residential Code for One- and Two-Family Dwellings and the 2006, 2009, 2012 & 2015 International Building Code. HardiePanel vertical siding is also recognized for application in the following: City of Los Angeles Research Report No. 24862, State of Florida Product Approval FL#13223, Miami-Dade County Florida NOA No. 17-0406.06, U.S. Dept. of HUD Materials Release 1263f, Texas Department of Insurance Product Evaluation EG-23, City of New York MEA 223-93-M, and California DSA PA-019. These documents should also be consulted for additional information concerning the suitability of this product for specific applications.