



JL INDUSTRIES

ROOF ACCESSORIES



Division 07 72 33

**Roof Hatches
Roof Safety Rails
Safety Posts**

Division 07 72 36

Smoke Vents

ACTIVAR
INC.

www.activar.com

Construction Products Group



ROOF HATCHES & SAFETY RAILINGS

ROOF HATCH: Galvanized Steel or Aluminum RHG & RHA Series



Certifications: **RHG** (galvanized) models include components or materials that are ASTM certified under Specifications A792/A792M-06a; A653/A653M-06a; C726-05; and A36/A36M-05. **RHA** (aluminum) models include components or materials that are ASTM certified under Specifications 209-06 and C726-05.

Load/Deflection: Both steel and aluminum roof hatch covers have been tested and approved to support a minimum live load of 40 lbs./ft.² with a maximum deflection of 1/150th of the span, maximum negative load of 50 lbs./ft.² wind uplift, and 110 mph wind load when cover is in an open position.

Insulation: The curb includes a 1" fiberboard insulation surrounding the base, and 1" mineral wool insulation between the exterior cover and liner.

Construction: **RHG:** 14 gauge galvanized steel with 12" high curb and 3 5/8" wide flange for securing to roof deck. The cover includes a 14 gauge galvanized steel exterior and 22 gauge liner with with a TPE draft seal gasket door seal. **RHA:** .090 aluminum with 12" high curb and 3 5/8" wide flange for securing to roof deck. The cover includes a .090 aluminum exterior and .040 aluminum liner with a TPE draft seal gasket door seal.

Hardware: Hardware includes a heavy duty hinge, slam latch, heavy gauge automatic hold open arm with red grip, compression spring-operated cylinder, exterior handle with integral padlock hasp, and interior locking handle with interior padlock hasp.

Finish: **RHG:** Bonderite®, pre-treated grey hammertone powder coat. **RHA:** Bonderite®, pre-treated bronze powder coat.

Options: Saf-T-Hatch Safety Railing, Gravity-operated battery-powered flashing warning light, LP-4,5 or 6 ladder post.

Model	Opening Size	Weight
RHA-1	30" x 36"	90 lbs.
RHA-2	54" x 30"	115 lbs.
RHA-3	96" x 30"	190 lbs.
RHA-4	36" x 36"	110 lbs.
RHA-5	48" x 48"	160 lbs.

Custom Sizes Available Upon Request

Model	Opening Size	Weight
RHG-1	30" x 36"	150 lbs.
RHG-2	54" x 30"	210 lbs.
RHG-3	96" x 30"	315 lbs.
RHG-4	36" x 36"	185 lbs.
RHG-5	48" x 48"	260 lbs.

Custom Sizes Available Upon Request

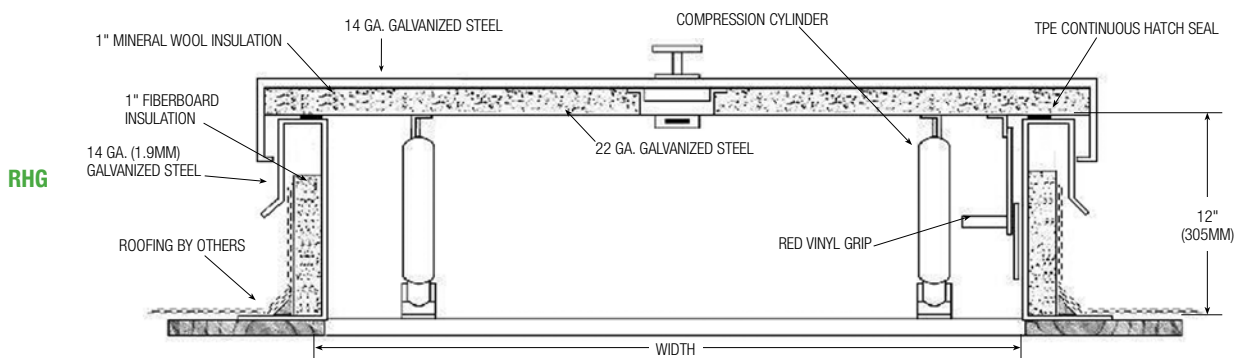
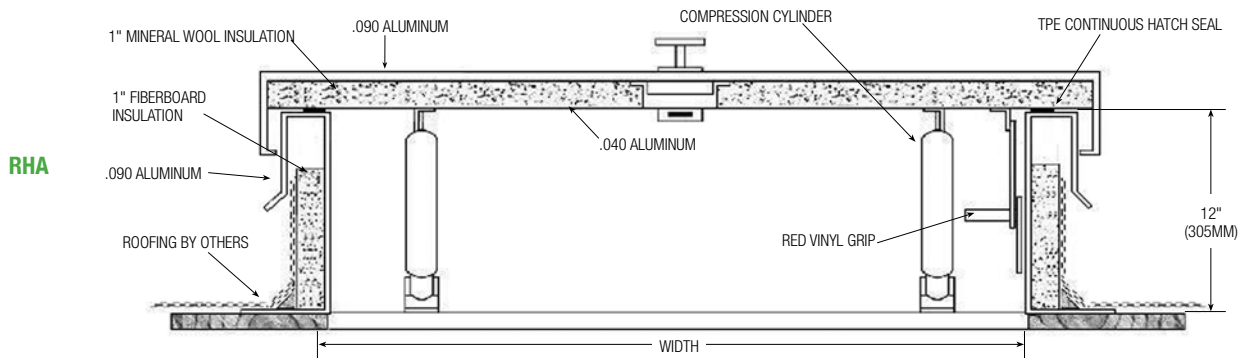



RETROFIT GALVANIZED ROOF HATCH: RHR Series

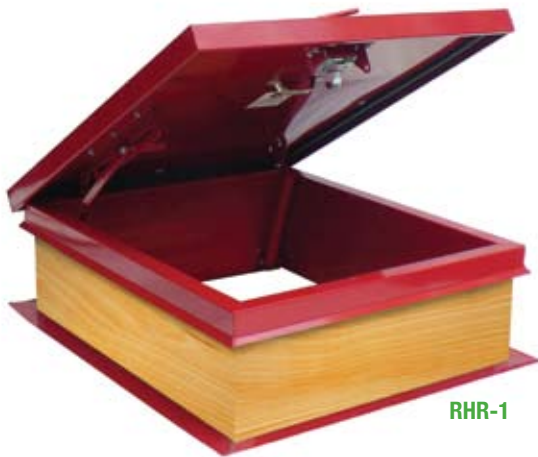

RHR-1

Load/Deflection: Roof hatch cover has been tested and approved to support a minimum live load of 40 lbs/ft² with a maximum deflection of 1/150th of the span.

Insulation: The curb includes 1" x 11" pine board surrounding the base. The cover has 1" mineral wool insulation in the space between the exterior cover and liner.

Certifications: The RHR includes components or materials that are ASTM certified under Specifications A792/A792M-06a; A653/A653M-06a; C726-05; and A36/A36M-05.

Construction: Hatch is 16 gauge galvanized steel with 12" high curb and 3-5/8" wide flange for securing to roof deck. The cover includes a 16 gauge galvanized steel exterior and 22 gauge liner with an EPDM gasket door seal.

Hardware: Hardware includes a heavy-duty hinge, heavy-gauge automatic hold-open arm with red grip, compression spring-operated cylinders, rubber-coated exterior handle with integral padlock hasp and interior latching handle with padlock hasp.

Finish: Bonderite™ red powder coat.

Options: Gravity-operated battery-powered flashing warning light, Saf-T-Hatch safety rail (STH-1).

Model	Opening Size	Weight
RHR-1	30" x 36"	137 lbs.
Custom Sizes Available Upon Request		

- Economical Roof Hatch Replacement
- 16 Gauge Galvanized Steel Construction
- RHG Series Features & Hardware
- Meets Industry Test Standards
- Bonderite™ Pre-Treated Red Hammertone powder coat
- No Painting Necessary
- Ready for Installation
- Custom Sizes Available

SAF-T-HATCH ROOFTOP SAFETY RAILING FOR NEW & EXISTING HATCHES: STH Series (Patented Saf-T-Hatch Railing)



Certifications: Meets OSHA required compliance for safe egress and ingress through rooftop hatch openings while hatch is in use. Complies with OSHA CFR 29-1910.232 and CFR 29-1910.27.

Construction: Rail: 1-5/8" OD A53 grade B seamed galvanized steel with zinc-plated post caps. The base is factory galvanized 2" x 2" 16 gauge seamed steel with cast steel hot dipped galvanized clamps.

Guard: Zinc-plated 3/16" ASTM chain with quick links and hoops.

Finish: Safety Yellow Powder Coating.

Installation: Quickly installs by a clamping frame around curb base of roof hatch or fire hatch. Does not require "approved" installer. Fits all brands of existing roof hatches with cap flashing—field adjustable to fit flashing size.

Options: Self-closing, rigid steel gate painted safety yellow, - STHG-24 fits RH1,2,3 Models (17 lbs) and STHG-36 fits RH4 & 5 Models (20 lbs).

Model	Opening Size	Weight	Fits Roof Hatch Model
STH-1	30" x 36"	66 lbs.	RHA/RHG/RHR-1
STH-2	54" x 30"	70 lbs.	RHA/RHG-2
STH-3	96" x 30"	80 lbs.	RHA/RHG-3
STH-4	36" x 36"	68 lbs.	RHA/RHG-4
STH-5	48" x 48"	75 lbs.	RHA/RHG-5
Custom Sizes Available Upon Request			

ROOF HATCHES & SAFETY RAILINGS

SAF-T-HATCH RAIL SYSTEM: RHG-STH Series JL RHG Series Roof Hatch with Safety Rail



- Integral Roof Access Safety System
- OSHA-Compliant for Rooftop Safety
- 4 Standard Sizes - Custom Sizes Available
- Durable, Powder Coat Factory Finish
- No Painting Required - Installation Ready
- Safety Rail Assembles Easily in Minutes
- Assembly Tools & Hardware Included
- Roof Hatch with Railing Sold as One Unit
- Optional Gate & "Open Hatch" Warning Light
- Factory-installed Mounting Brackets

SAFETY RAIL: Model STH

Certifications: Rail meets OSHA-required compliance for safe egress and ingress through rooftop hatch openings while hatch is in use. Complies with OSHA CFR 29-1910.232 and CFR 29-1910.27.

Construction: Rail is 1-5/8" OD A53 grade B seamed galvanized steel with zinc-plated post caps. Rail support brackets are welded to the curb. Posts are mechanically-secured to the brackets.

Hardware: Safety chain is zinc-plated 3/16" ASTM chain with quick links and hoops.

Finish: Durable Safety Yellow powder coat finish.

Options: Rigid galvanized self-closing gate. Gravity-operated Roof Hatch "Open" warning light.

GALVANIZED ROOF HATCH: Model RHG

Certifications: RHG models include components or materials that are ASTM certified under Specifications A792/A792M-06a; A653/A653M-06a; C726-05 and A36/A36M-05)

Load/Deflection: Roof hatch cover has been tested and approved to support a minimum live load or 40 lbs/ft² with a maximum deflection of 1/150th of the span, maximum negative load of 50 lbs/ft² wind uplift, and 110 mph wind load when cover is in upright position.

Insulation: The curb includes 1" fiberboard insulation surrounding the base. The cover has 1" fiberglass insulation in the space between the exterior cover and liner.

Construction: Hatch is 14 gauge galvanized steel with 12" high curb and 3 5/8" wide flange for securing to roof deck. The cover includes a 14 gauge galvanized steel exterior and 22 gauge liner with an EPDM gasket door seal.

Hardware: Hardware includes a heavy-duty hinge, heavy-gauge automatic hold-open arm with red grip, compression-operated shock-absorbing cylinders, exterior handle with integral padlock hasp and interior latching handle with padlock hasp. Pre-installed bolts on the counter flashing assist in retaining the membrane materials against the curb.

Finish: Hatch - Bonderite™ pre-treated gray hammertone powder coat.

Options: Gravity-operated battery-powered flashing warning light.

Model	Opening Size	Weight
RHG-1-STH	30" x 36"	183 lbs.
RHG-2-STH	54" x 30"	245 lbs.
RHG-4-STH	36" x 36"	219 lbs.
RHG-5-STH	48" x 48"	298 lbs.

Custom Sizes Available Upon Request



DOUBLE LEAF SMOKE VENT: UFV Series UL-LISTED

Certifications: UL Listed. The smoke vents are equipped with a UL listed 165° F fusible link for automatic operation.

Construction: Covers are 11 gauge aluminum insulated with fiberglass, 14 gauge galvanized steel curb and curb frame fully welded and ground smooth, gasketed and insulated for weather tightness.

Operation: Torsion spring drives open the covers automatically. Shock absorbers control the speed of the leaves as they open. The fusible link can be quickly and easily replaced.

Hardware: Heavy gauge aluminum 3/16" pivot hinges. Pull handles are provided for exterior or interior manual operation.

Finish: 2 coats of factory-applied primer.

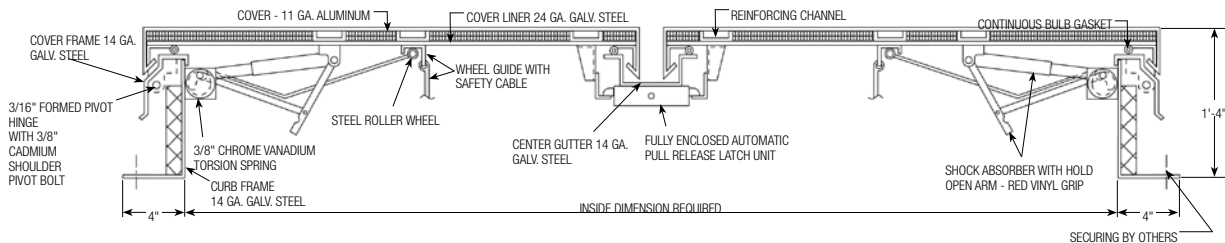

Clear Opening Size	48" x 48"	48" x 72"	48" x 90"	48" x 96"	60" x 60"	60" x 96"			
UL-Listed	UFV-1	UFV-2	UFV-3	UFV-4	UFV-5	UFV-6			
Custom Sizes Available Upon Request • Fusible Links with Higher Temperature UL-Listings Available Upon Request									

DOUBLE LEAF DOMED SMOKE VENT: UDFV Series

Certifications: The smoke vents are equipped with a UL listed 165° fusible link for automatic operation.

Construction: Dome frame is a minimum thickness of .072 aluminum and provides a self-contained sloping condensation and weepage gutter for drainage. Covers are one-piece acrylic dome (either white translucent or clear). The 14 gauge galvanized steel dome retaining frame is secured to the 14 gauge galvanized steel curb frame. The galvanized steel curb and curb frame are fully welded and ground smooth, gasketed and, insulated for weather tightness.

Operation: Torsion spring drives open the covers automatically. Shock absorbers control the speed of the leaves as they open. The fusible link can be quickly and easily reset and a new link inserted.

Hardware: Heavy gauge aluminum 3/16" pivot hinges. Pull handles are provided for exterior or interior manual operation.

Finish: 2 coats of factory-applied primer.

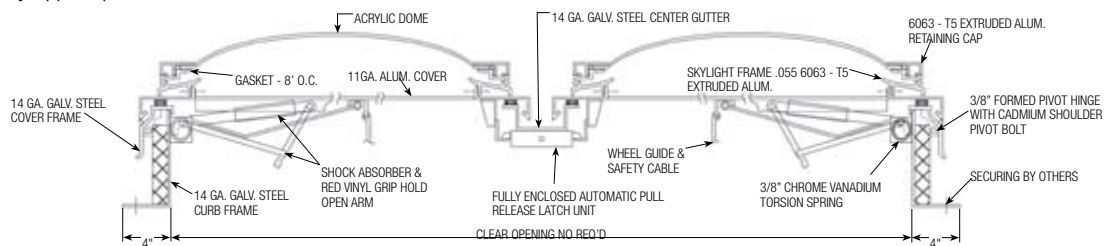

Clear Opening Size	48" x 48"	48" x 72"	48" x 90"	48" x 96"	60" x 60"	60" x 96"			
UL LISTED	UDFV-1	UDFV-2	UDFV-3	UDFV-4	UDFV-5	UDFV-6			
Custom Sizes Available Upon Request • Fusible Links with Higher Temperature UL-Listings Available Upon Request									

EQUIPMENT HATCHES



EQUIPMENT HATCH: EHA & EHG Series

Insulation: The lid has 1" fiberglass insulation in the space between the exterior cover and liner.

Construction: Hatch is 14 gauge galvanized steel (EHG) or .090 aluminum (EHA) fully welded and ground smooth for weather tightness. Includes 12" high curb and 4" wide flange for securing to roof deck. The cover includes a 14 gauge galvanized steel or .090 aluminum exterior and metal liner with a

continuous bulb-neoprene door seal. Oversize doors may be spliced.

Hardware: Hardware includes heavy-duty galvanized hinges, compression spring automatic hold-open and operating arms with red vinyl handlegrip. For models 7' or larger - adjustable torsion spring automatic hold-open is provided. Lid hardware has a 2 point universal spring latch, and exterior and interior handles with integral padlock.

Finish: 2 coats prime coat.

Options: White Dome, Clear Dome. (RHWL) Gravity-operated battery-powered flashing warning light. (STH) Saf-T-Hatch railing. Custom Sizes & Finishes Available - Consult Factory.



Clear Opening Size	72" X 96"	60" X 120"	120" X 120"	144" X 144"
Aluminum	EHA-1	EHA-2	EHA-3	EHA-4
Galvanized	EHG-1	EHG-2	EHG-3	EHG-4

Custom Sizes Available Upon Request

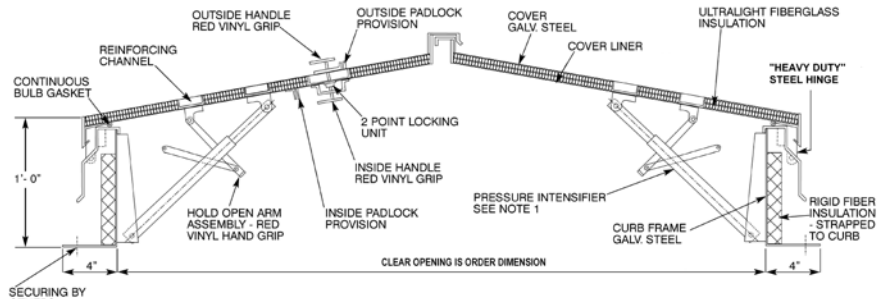

DOMED EQUIPMENT HATCHES - DEHG & DEHA Series

Insulation: The lid has 1" fiberglass insulation in the space between the exterior cover and liner.

Construction: Curb and curb frame are 14 gauge galvanized steel or .090 aluminum, fully welded and ground smooth for weather tightness. Includes 12" high curb with rigid insulation and 4" wide flange for securing to roof deck. The lid includes a one piece dome (or multiples) of either white

translucent or clear colorless acrylic, a dome frame of extruded aluminum #6063-T5 with minimum thickness of .070 provided with a self-contained sloping condensation and weepage gutter for drainage. Lid construction is galva-nized steel or aluminum exterior with metal liner and continuous bulb gasket door seal. Oversize doors may be spliced.

Hardware: Hardware includes heavy-duty galvanized hinges, compression spring automatic hold-open and operating arms with red vinyl handlegrip. For models 7' or larger - adjustable torsion spring automatic hold-open is provided. Lid hardware has a 2 point universal spring latch, and exterior and interior handles with integral padlock.

Finish: 2 coats prime coat.
Options: White Dome, Clear Dome. (RHWL) Gravity-operated battery-powered flashing warning light. (STH) Saf-T-Hatch railing. Custom Sizes & Finishes Available - Consult Factory.



Clear Opening Size	72" X 96"	60" X 120"	120" X 120"	144" X 144"
Aluminum	DEHG-1	DEHG-2	DEHG-3	DEHG-4
Galvanized	DEHA-1	DEHA-2	DEHA-3	DEHA-4

Custom Sizes Available Upon Request

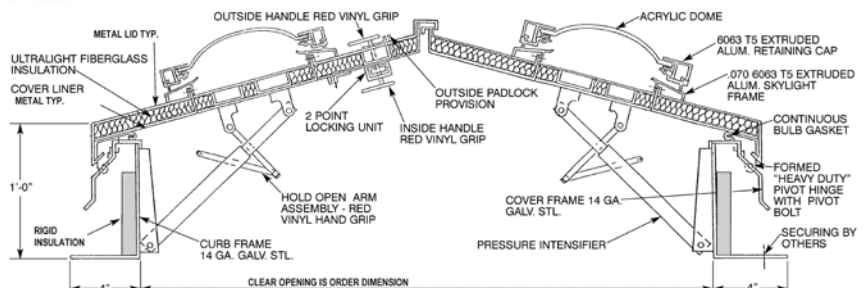



SAFETY POST—EXTENDABLE: LP-4 & LP-5

The LP-4 Safety Post provides a convenient and safe method of climbing off and onto fixed access ladders. Meets ANSI A14.3 and OSHA requirements.

Installation: The LP-4 Safety Post comes pre-assembled and attaches directly to the top two rungs (square or round) with two U-shaped bolts.

Ease of Use: When at the top of the ladder, extend the safety post. The spring coil allows user to lift with just one hand. Step on or off the ladder in a safe standing position while holding onto the post. A latch maintains the post at variable heights and is easily released for retracting the post.

Safety Features: Square posts for a no-slip grip and a ring at top for a harness. We recommend a Saf-T-Hatch rail system in addition to the LP-6 Safety Post for greater safety.

Weight: 25 lbs

Finish LP4: Safety Yellow Powder Coat

Finish LP5: Hot-Dip Galvanized

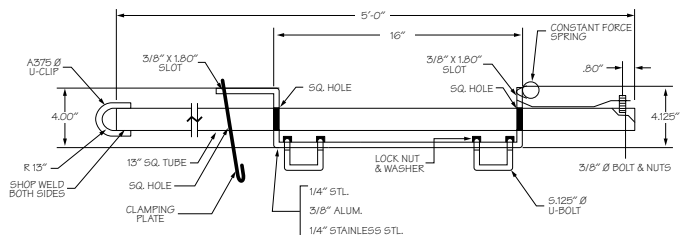

Side View

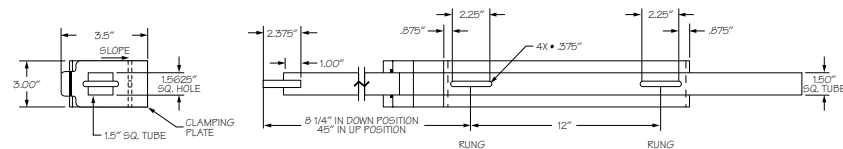

Side View

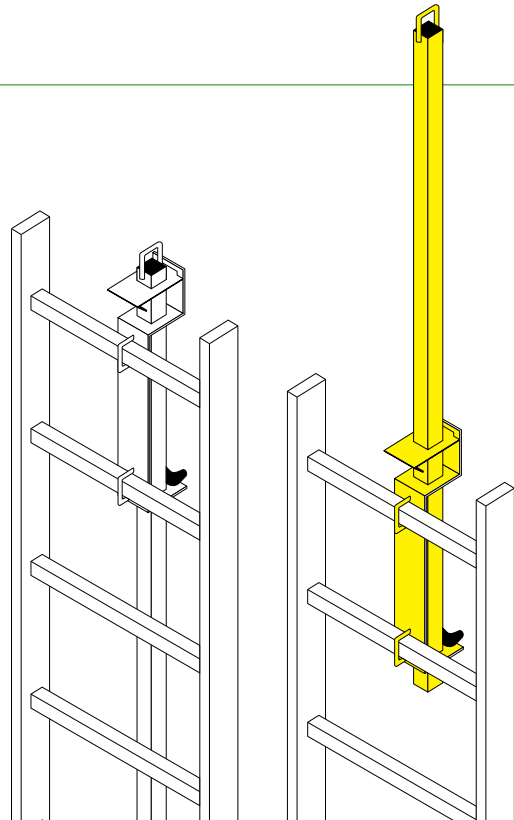

SAFETY POST—RETRACTABLE: LP-6

The LP-6 Safety Post has a patent-pending **curb-mount design** that is easily installed and stows inside the existing roof hatch curb. The post can be easily retracted and the roof hatch closed for safety while the user is on the roof. Complies with OSHA, CFR 29-1910.232 and CFR29 of 1910.27.

Installation: Mounts to top of curb with six self-tapping screws.

Ease of Use: After the user opens the roof hatch, the post is raised with one hand and locked into an upright position. The user can then climb from the ladder the rooftop using the post for a handhold.

Safety Features: Allows the roof hatch to be closed while user is on the roof. We recommend a Saf-T-Hatch rail system in addition to the LP-6 Safety Post for greater safety.

Weight: 6 lbs

Finish : Safety Yellow Powder Coat



ACCESSORIES



OPTIONAL GATE FOR SAF-T-HATCH RAILINGS: STHG

Increase rooftop safety with a self-closing, rigid galvanized steel gate with spring hinge for JL's Saf-T-Hatch railings. Fits both stand-alone STH and integrated RHG-STH models. Safety yellow painted. Galvanized steel clamps.

Saf-T-Hatch	Gate	Weight
STH-1	STHG-24	17 lbs.
STH-2	STHG-24	17 lbs.
STH-3	STHG-24	17 lbs.
STH-4	STHG-36	20 lbs.
STH-5	STHG-36	20 lbs.

Custom Sizes Available Upon Request



ROOF HATCH WARNING LIGHT – RHWL

The warning light is designed to alert personnel that the roof top opening or hatch is in the open position. A very bright, red, xenon strobe light emitting 60 double flashes per minute is activated as soon as the hatch is lifted upward 30 degrees. The strobe automatically turns "Off" when the hatch is in the closed position. Installation & Operation: Mounted on the inside surface of the hatch with its magnetic base, the Model RHM-2P-R-S features a built-in tilt switch that is located in its battery compartment. This switch automatically triggers the strobe to its flashing mode when the hatch is lifted upward. Two (2) new D-Cell alkaline batteries provide 50-60 flashing hours. The "Hatch Alert" is not intended to replace roof top safety initiatives or Saf-T-Hatch rail systems but rather to be used in conjunction with them. The flashing signal is an additional alert that the hatch is open.



WARRANTY—All products carry a one year warranty after date of shipment against defects in materials and workmanship. We will replace or repair any product found defective within this period at our discretion. No other warranty express or implied is valid.

MANUFACTURING/WAREHOUSING LOCATIONS

VISA **MasterCard**

ACPG WEST COAST WAREHOUSE
RENTON, WASHINGTON

ACPG HEADQUARTERS
JL INDUSTRIES
4450 W. 78TH STREET CIRCLE, BLOOMINGTON, MN 55435
PHONE: 800-554-6077 FAX: 952-835-2218
E-MAIL: SALES@JLINDUSTRIES.COM
WEB SITE: WWW.JLINDUSTRIES.COM

ACPG CHICAGO WAREHOUSE
WOOD DALE, ILLINOIS

ACPG EAST COAST WAREHOUSE
LANCASTER, PENNSYLVANIA

ACPG ATLANTA WAREHOUSE
ATLANTA, GEORGIA

ACPG SOUTH WAREHOUSE
GRAND PRAIRIE, TEXAS

ACPG WEST COAST SAMSON PRODUCTS
6285 RANDOLPH STREET, COMMERCE, CA 90040
PHONE: 800-554-6077 FAX: 952-835-2218
E-MAIL: SALES@SAMSONPRODUCTS.COM
WEB SITE: WWW.SAMSONPRODUCTS.COM

ACPG SOUTHEAST THOMAS ENTERPRISES
5765 CORPORATION CIRCLE, FORT MYERS, FL 33905
PHONE: 800-780-7501 FAX: 239-693-7501
E-MAIL: SALES@THOMASE.COM
WEB SITE: WWW.THOMASE.COM

The Activar Construction Products Group (ACPG) consists of 5 affiliated companies that serve the commercial construction industry. Our multiple product lines are a single source for architects and distributors. Air Louvers manufactures products for the openings market with door lites, louvers and rated-glass. Hiawatha is known for its quality architectural door hardware and frameless shower door products. JL Industries is an industry leader in fire protection, providing fire extinguishers, AEDs and cabinets, access panels, roof opening products and entrance flooring systems. Samson Products manufactures many of the products sold under the JL label and distributes JL products on the West Coast. Thomas Enterprises is our Southeast distributor for JL products and has a state-of-the-art aluminum fabrication facility for fire extinguisher cabinets sold under the Thomas and JL labels.