

SAFETY RAILING - RSHWC - COMPRESSION INSTALLATION & MAINTENANCE GUIDE | 14I-418

GENERAL:

Compression Safety Railings are designed to retrofit any roof hatch as they compress to the counterflash of the curb. The following installation guide is the manufacturers recommended steps for installation. Please install according to local building codes and practices.

TOOLS NEEDED:

(Provided by others)

- Power drill
- T30 Torx Bit (PN# TORX-T30-BIT)
- 1/4" Allen Wrench
- 1/4" Hex bit (for the set screws)
- (2) 3/4" wrench

INSTALLATION:

Note: It is preferable to install the safety rail with two people

1. Place the two compression side mount assemblies with the corner post brackets on the non-gate sides of the roof hatch. The corner post brackets should face outward, away from the hatch. (Fig. 1)
2. Put one conduit tube with threaded nut ends on gate side and the other conduit tube on the opposite side. Select the hole locations in the compression side mount assembly that best fit around the roof hatch. Loosely attach the conduit tubes and compression mount assemblies together with 1/2"- 13 x 4" hex bolts on each side. (Fig. 2 & 3)
3. Install four pieces of 2" x 2" grip tape to the four corners of the roof hatch counterflashing to provide additional friction to hold compression railing in place (Fig. 4). With two people, lift up the entire compression mount assembly onto the counterflash of the roof hatch and hand tighten the bolts. (Fig. 5)
Also, there may be multiple vertical posts with fittings to secure in place.

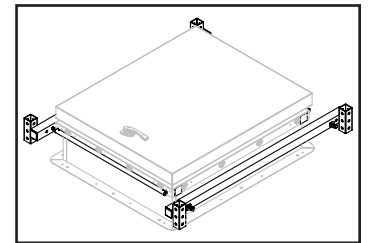
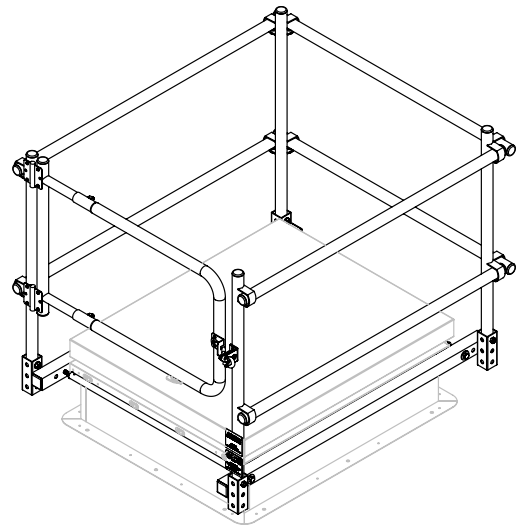

FIG. 1

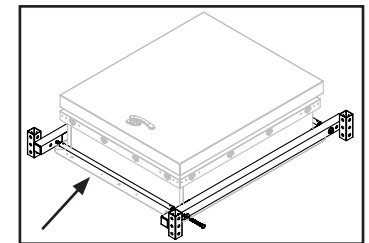

FIG. 2

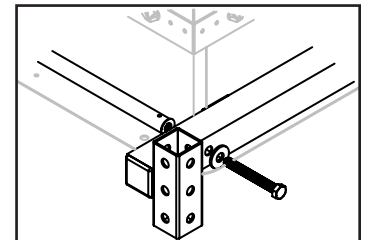

FIG. 3 - Close up view

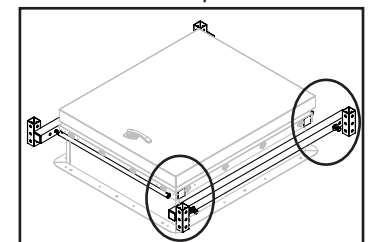

FIG. 4

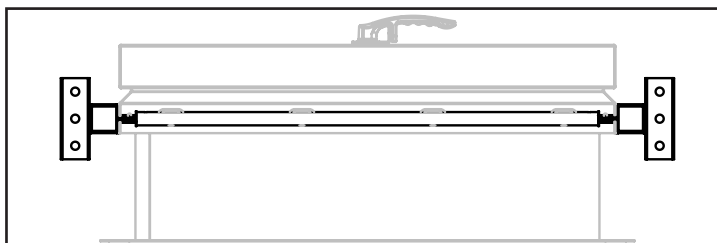

FIG. 5



JL INDUSTRIES



MAXAM
METAL PRODUCTS



DUR-RED
PRODUCTS

800-554-6077

sales@activarcpg.com

www.activarcpg.com

Installation &
Maintenance Guide

14I-418

REV A 8-9-2024

SAFETY RAILING - RSHWC - COMPRESSION - INSTALLATION & MAINTENANCE GUIDE

NOTE: Vertical posts have predrilled holes for mounting the gate hinges and latch. Confirm you have the correct vertical post in the right location. (Reference exact submittal with assembly)

4. Install vertical post into corner bracket, using $\frac{1}{2}$ "-13 x 2-1/2" bolts & $\frac{1}{2}$ "-13 flange nut. Select one of the three mounting positions in the corner bracket so that the top rail resides at 42" above the walking surface, to insure code compliance. Install all 4 vertical posts. (Fig. 6)

For larger safety railings there will be a swedged joint to combine the horizontal rails together. Then put the outside cap over it.

5. Install the horizontal rails, making sure they are correctly located. (Fig. 7)
 - a. Horizontal rails are secured in place using set screws. Be sure all set screws are backed out.
 - b. Slide horizontal rails into brackets along top and middle locations.
 - c. Use the $\frac{1}{4}$ " hex bit to tighten the $\frac{1}{2}$ "-13 x $\frac{3}{4}$ " set screws at the bottom of each bracket to tighten the horizontal rails.

NOTE FOR DOMED ROOF HATCHES: Remove back mid rail to ensure dome does not interfere.

6. Install the gate. Our standard gate opens left handed, with the hinges on the left hand side.
 - a. Disassemble telescoping gate into two pieces.
 - b. Install both hinges of the hinged piece to the left hand corner post (Fig. 8)
 - c. Install the latch catch assembly into the opposite corner post with the provided $\frac{1}{4}$ " -20 x $\frac{3}{4}$ " Torx screws using the T-30 Torx bit and drill. (Fig. 9, left side)
 - d. Screw the hook into the U bent gate piece using the $\frac{1}{4}$ "-20 x $\frac{3}{4}$ " Torx screws. (Fig. 9, right side)
 - e. Install telescoping side of the gate with installed hook onto the hinged piece to fit exit opening. Make sure the hook pin properly engages the latch catch and tighten set screws. (Fig. 10)
 - f. Open the gate 90 degrees and release to verify the gate will self close and self latch. If needed, use $\frac{5}{32}$ " Allen wrench (included) to adjust the hinge spring tension.

OPERATION:

Press the gravity latch catch up and pull open the gate. (Fig. 11) The gate automatically self-closes and self-latches with adjustable spring hinges.

NOTE: The standard gate opens left handed. If you need a right handed opening gate a special latch kit is required. (PN# RSH-KIT-LATCHPINL) .

MAINTENANCE:

Manually operate once a year to check functionality of moving parts such as latches and hinges. Periodically clean latches and strikes of old grease and dirt using a clean dry cloth. Reapply lubrication as needed. Inspection shall include checking frame alignment, check that all nuts, bolts, and clamps are tight, weight distribution, and improper installation causing damage or failure.

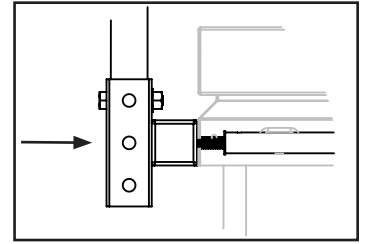

FIG. 6

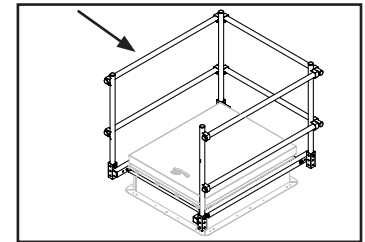

FIG. 7

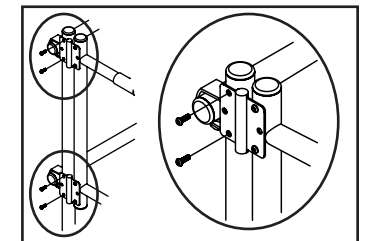

FIG. 8

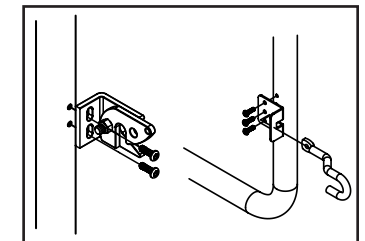

FIG. 9

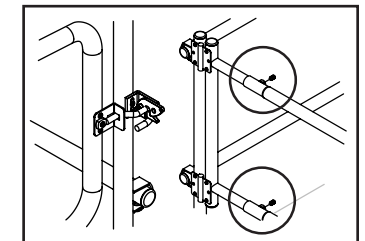

FIG. 10

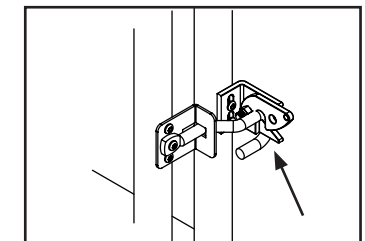

FIG. 11