



Cold Applied



Heat Weld



Mechanically
Fastened



APP Roofing Systems

Commercial Roofing Application Guide

Table of Contents

Section One

Roof Insulation Application Guide	1-1
Roof Insulation Fastener Placement	1-3
Roof Insulation Attachment Patterns	1-10

Section Two

APP Heat-Welded Application Guide	2-1
APP Modified Bitumen Cold-Applied Application Guide.....	2-21

Section Three

Mechanically Fastened Base Sheet Fastening Patterns.....	3-2
--	-----

Section Four

JM APP Flashing Details Introduction.....	4-1
Contents.....	4-6
JM PermaFlash® Flashing System Application Guide	4-8
JM PermaFlash® Flashing Details	4-12
Heat-Weld Flashing Details	4-33
Vapor Barriers	4-67



Download a free QR Reader app on your smart phone. When you see a QR code, use your phone to scan the code. It will then redirect your phone to a specific video or detail. These codes will allow you to view step by step instructional videos and will allow you to zoom in on details for better readability. If you are viewing this booklet online you can click on these codes to direct you to the online videos and details as well.

Disclaimer:

The Roofing Systems Commercial Roofing Application Guide is intended as a guide only; actual conditions encountered during installation may vary from jobsite to jobsite. By providing this guidance, Johns Manville assumes no responsibility for quality of installation, field workmanship, building code compliance, or job safety. Johns Manville Safety Data Sheets (MSDS) are available with specific product safety information. For information on other Johns Manville thermal insulations and systems, call (800) 922-5922 or visit JM.com.

1

Roof Insulation Application Guide, and Fastening Patterns

Insulation Installation Considerations

It is important to know that all Johns Manville polyiso boards are printed with installation directions of "This side down". This installation method is required for adhered systems and recommended when used under mechanically attached membranes. Foam insulation products are combustible and should be properly protected from exposure to fire during storage, transit, and application.

Storage

JM roof insulations (polyiso, Invinsa[®], and FESCO[®]) are shipped with plastic shrouds that are intended to temporarily protect the insulation while in transit. There are two packaging methods (plastic wrap or plastic bag) that are used depending upon the product and the manufacturing facility. No matter how packaged, JM insulation should not be stored in or around standing water. Since all packaging is 5-sided, the pallets should be elevated and stored on a finished surface rather than on dirt or grass. Exercise care during handling to prevent insulation damage; avoid pushing pallets off the truck, rolling pallets on the ground or roof, and removing the package support feet. No more insulation should be installed than can be completely covered with membrane on the same day.

- **Plastic Wrap Packaging** is shipped to the job site with tarps. At the job site this packaging is adequate for outside storage without tarps provided the insulation arrives intact with the original undamaged weather-tight plastic wrap, for two weeks or less. For storage greater than two weeks, JM recommends slitting the plastic shrink wrap prior to covering the pallet with a breathable tarpaulin, to allow for venting. For storage greater than one month, insulation should be stored indoors in a dry, well-ventilated warehouse.



- **Plastic Bag Packaging** is shipped to the job site without tarps as this packaging protects the insulation during shipment. For storage less than two weeks, the packaging is adequate for outside storage without tarps provided the insulation arrives intact with the original undamaged weather-tight plastic bag. For storage greater than two weeks, JM recommends slitting the plastic shrink bag prior to covering the pallet with a breathable tarpaulin, to allow for venting. For storage greater than one month, insulation should be stored indoors in a dry, well-ventilated warehouse.



Installation

Insulation must be independently fastened to the roof deck in mechanically attached and adhered systems. Adhering certain insulations in hot asphalt or cold adhesives is sometimes acceptable for adhered systems (only for 4'x4' boards). For specific requirements, contact the JM Technical Services Group.

Always cut insulation to fit closely around all roof penetrations. Around drains, and primary scuppers, taper insulation a minimum of 36" x 36" (91.44 cm x 91.44 cm) for proper drainage.

Apply rigid insulation directly over fluted steel decks to provide smooth, continuous membrane support. Insulation should be installed with long edges parallel to the direction of the deck and supported by the deck flange. When butting insulation layers, do not allow the edge of either board to overlap an open flute. Cut the

insulation so the edge of the board is about at the center of, and supported by, the flange. Any gaps between insulation greater than 1/4" should be filled.

Double Insulation Layers.

Installing roof insulation in multiple layers provides the designer with improved thermal performance. It also contributes to the overall performance of the roof system for the following reasons:

- Recent studies indicate that as much as 8% of the thermal efficiency of the insulation can be lost through the insulation joints and exposed insulation fasteners of single layer installations. Insulation joints that are staggered in multiple layer installations block the flow of heat.
- Multiple layer insulation installation reduces the stress accumulation of a thick, single insulation joint and distributes the stress more evenly over the multiple, thinner insulation joints.
- The bottom side of the membrane is protected from physical damage from insulation plates and fasteners by the second layer of insulation if the top layer is adhered.
- Roof decks may be stiffened.



Asphalt Temperatures

JM endorses the guidelines established by the NRCA and ARMA for heating asphalt for proper insulation applications. Asphalt should be applied at the Equiviscous Temperature (EVT), $\pm 25^{\circ}\text{F}$ ($\pm 14^{\circ}\text{C}$).

Cold Weather Application

Hot asphalt chills rapidly at 40°F (4°C). To avoid problems associated with "cold" asphalt application, insulation may be applied with mechanical fasteners. Another method when using hot asphalt may be the "mop and flop" method. The "mop and flop" method entails mopping the back of the insulation so that the asphalt retains its adhesive qualities for a longer period. When adhering insulation, including hot asphalt, board size shall not exceed $4' \times 4'$ ($1.22 \text{ m} \times 1.22 \text{ m}$). Care should be taken in any application below 40°F (4°C).

Mechanical Application to Steel Decks

Mechanical attachment of insulation to steel decks is the only acceptable attachment method. For current information regarding Factory Mutual requirements over insulated steel decks, please check with a JM Technical Services Specialist, or the current FM ApprovalsSM RoofNav[®].

Adhesive Application

JM insulations may be installed in Insulation Adhesives:

- Two-Part Urethane Insulation Adhesive (2P-UIA) Bead Application Only
- One-Step Foamable Adhesive
- Roofing Systems Urethane Adhesive

Board sizes shall not exceed $4' \times 4'$ ($1.22 \text{ m} \times 1.22 \text{ m}$). Refer to product data sheets for adhesive coverage rates.

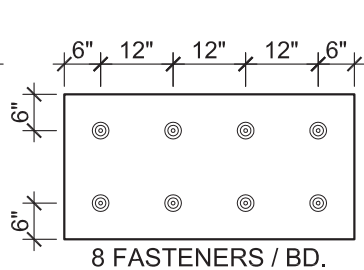
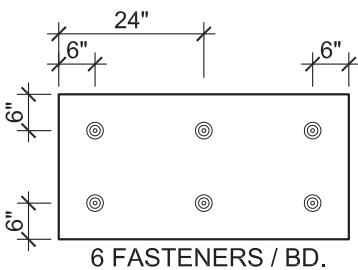
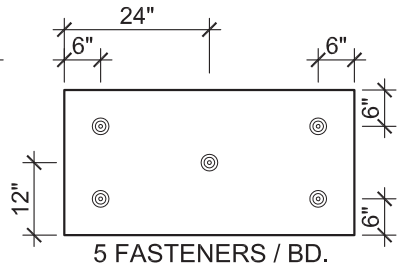
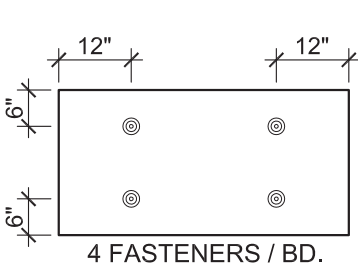
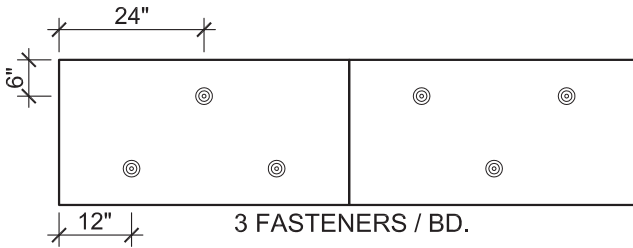
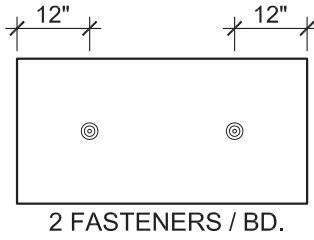

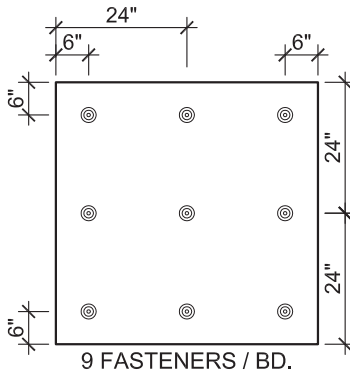
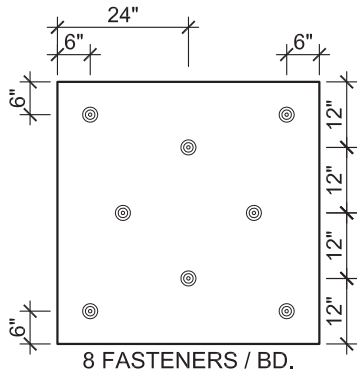
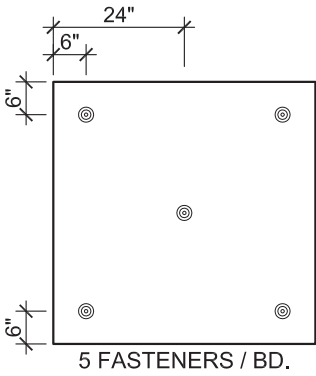
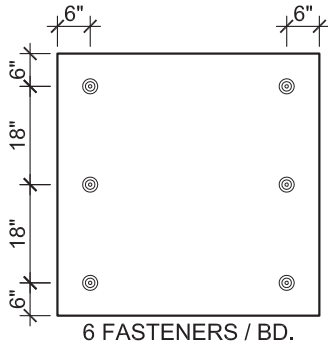
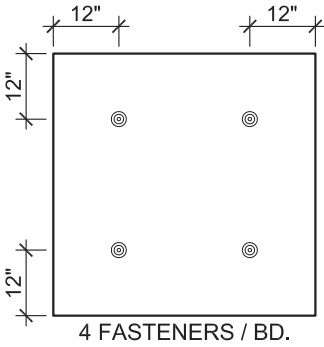

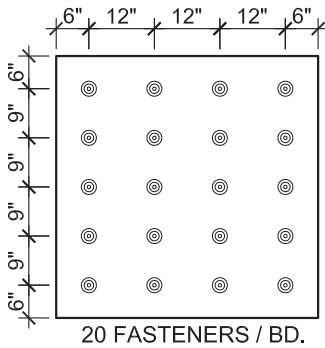
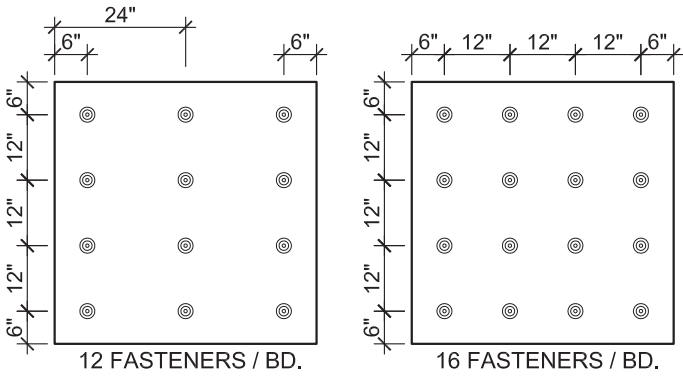
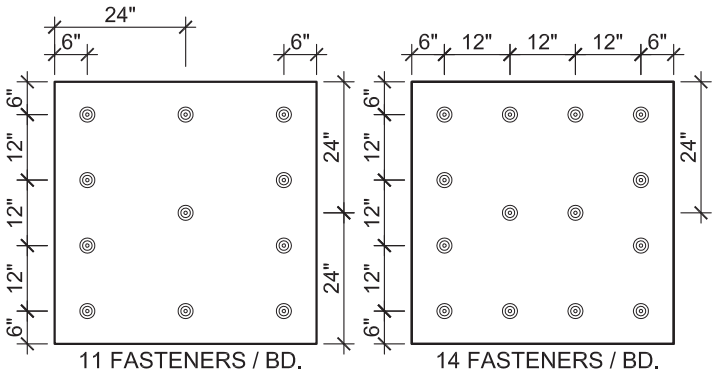

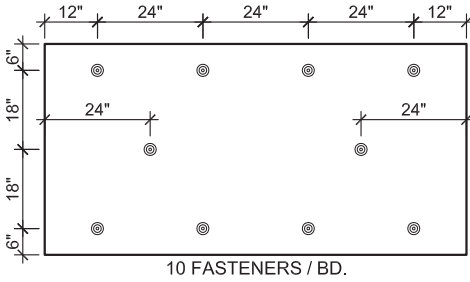
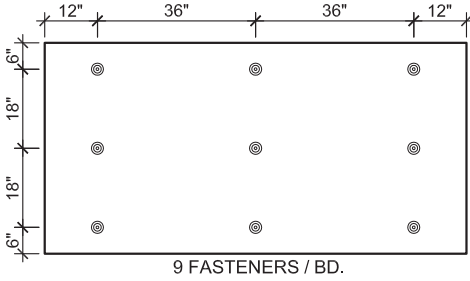
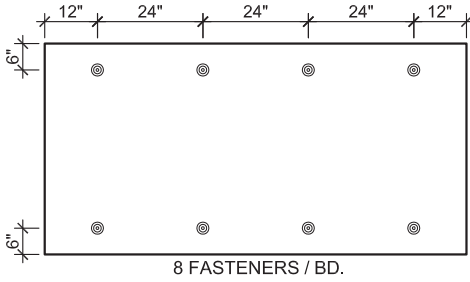
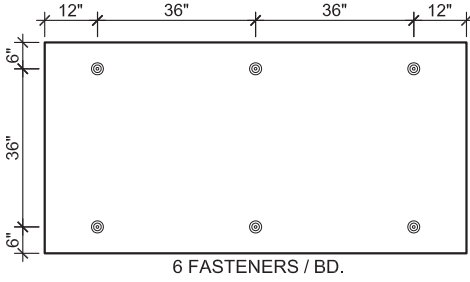
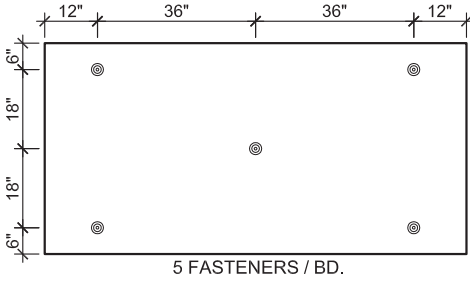

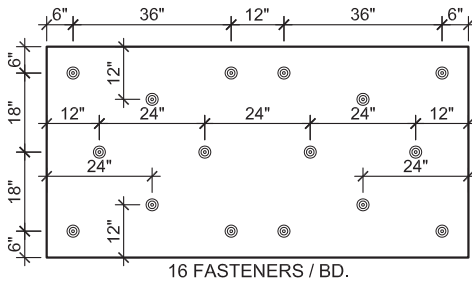
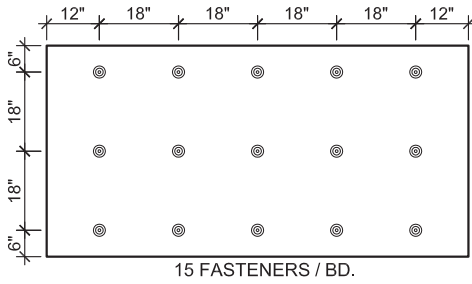
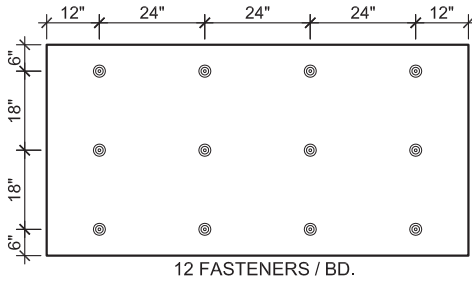
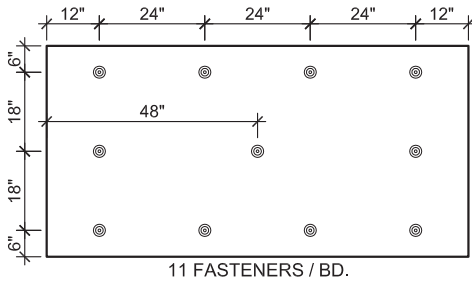

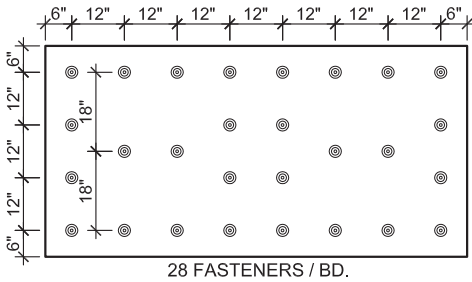
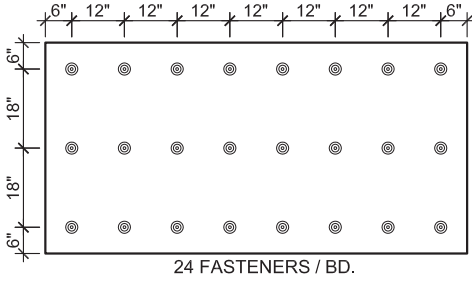
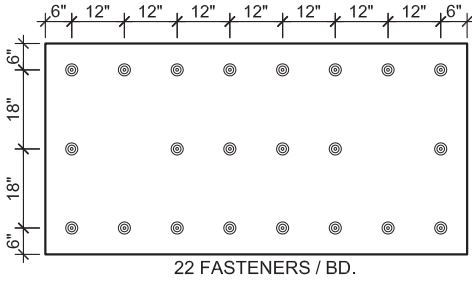
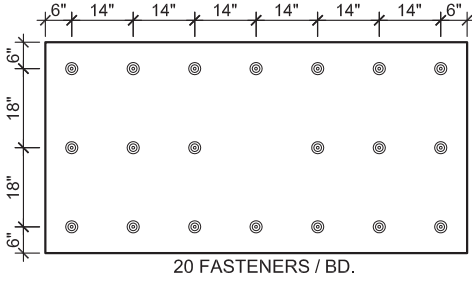
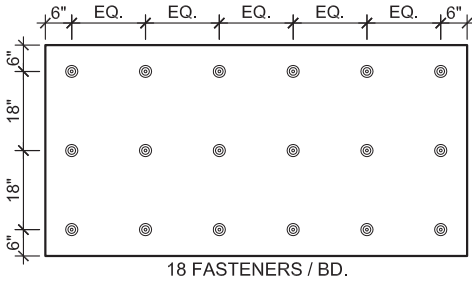

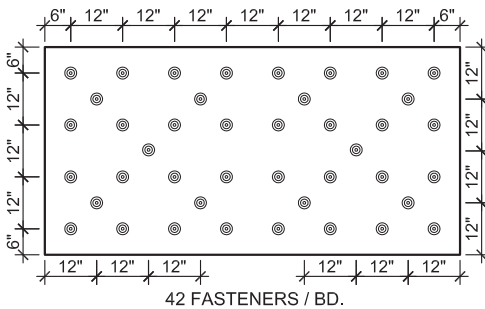
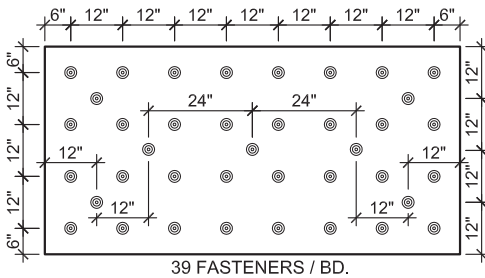
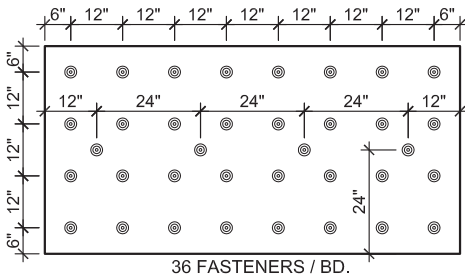
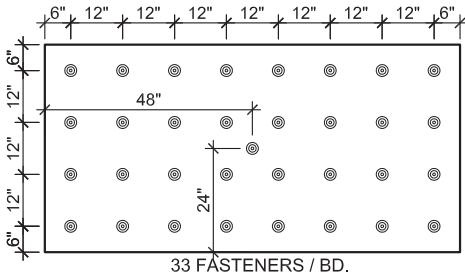
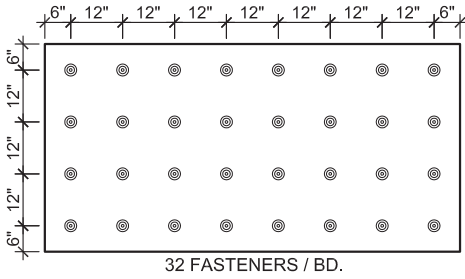

BOARD LAYOUT

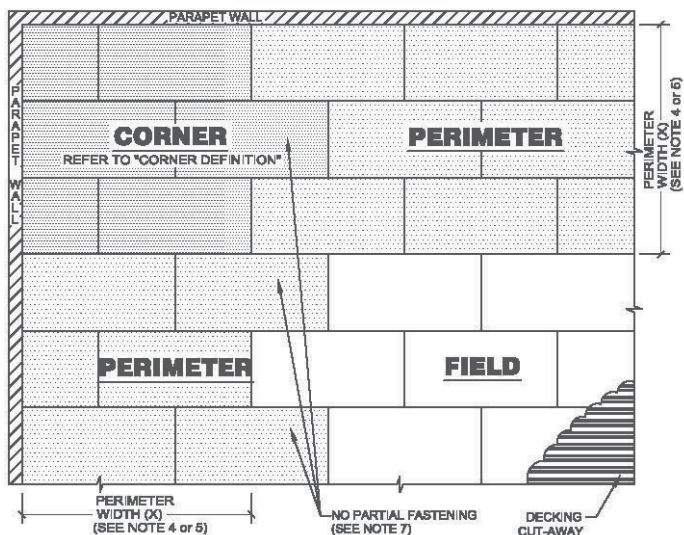

8 FASTENERS (1:4 FT²)

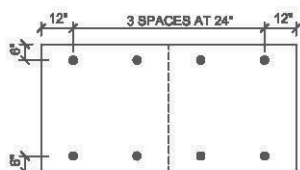

FIELD

16 FASTENERS (1:2 FT²)

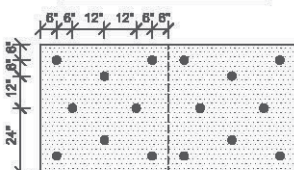

PERIMETER

32 FASTENERS (1:1 FT²)

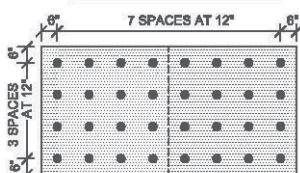

CORNER

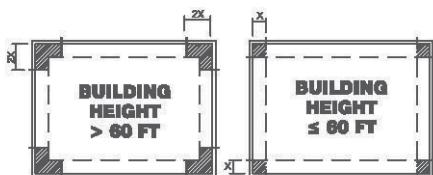

CORNER DEFINITION

(SEE NOTES 4, 5 & 6)

NOTES

1. CALCULATE UPLIFT DESIGN PRESSURES IN ACCORDANCE WITH ASCE-7.
2. INSTALL INSULATION WITH LONG JOINTS IN A CONTINUOUS STRAIGHT LINE WITH END JOINTS STAGGERED.
3. ROOF HEIGHT \leq 60 FT, THE PERIMETER (X) IS THE SMALLER DIMENSION OF:
 - 10% OF THE SHORTEST SIDE (PLAN VIEW)
 - OR
 - 40% OF THE ROOF HEIGHT,
 - BUT
 - NOT LESS THAN 4% OF THE SHORTEST SIDE (PLAN VIEW) OR 3 FT.
4. ROOF HEIGHT $>$ 60 FT, THE PERIMETER (X) IS:
 - 10% OF THE SHORTEST SIDE (PLAN VIEW) BUT NOT LESS THAN 3 FT.
5. THE CORNERS MAY BE TREATED AS PERIMETERS IF THE PARAPET IS GREATER THAN OR EQUAL TO 3 FT ON ALL SIDES ACCORDING TO ASCE-7.
6. IF ANY PORTION OF THE BOARD LIES IN A PERIMETER OR CORNER ZONE, ENHANCE THE FASTENING OF ENTIRE BOARD.

BOARD LAYOUT

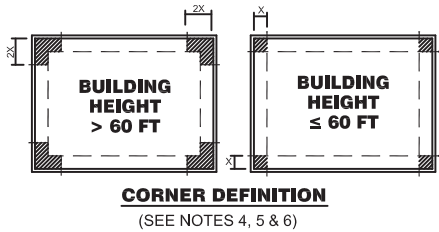
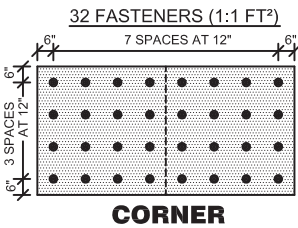
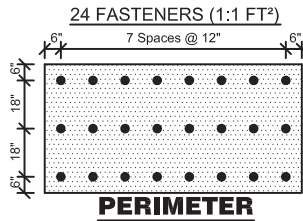
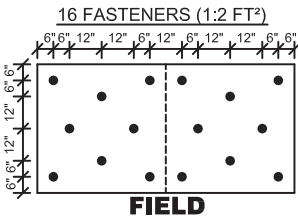
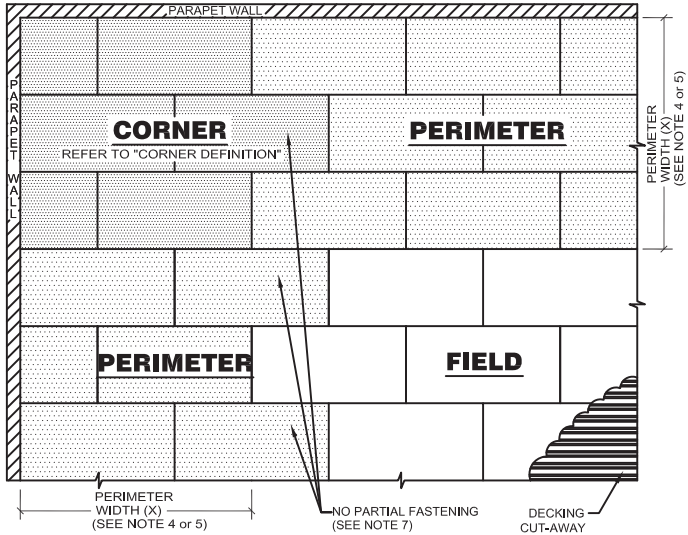

NOTES

- CALCULATE UPLIFT DESIGN PRESSURES IN ACCORDANCE WITH ASCE-7.
- INSTALL INSULATION WITH LONG JOINTS IN A CONTINUOUS STRAIGHT LINE WITH END JOINTS STAGGERED.
- ROOF HEIGHT \leq 60 FT, THE PERIMETER (X) IS THE SMALLER DIMENSION OF:
 - 10% OF THE SHORTEST SIDE (PLAN VIEW)
 - OR
 - 40% OF THE ROOF HEIGHT,
 - BUT
 - NOT LESS THAN 4% OF THE SHORTEST SIDE (PLAN VIEW) OR 3 FT.
- ROOF HEIGHT $>$ 60 FT, THE PERIMETER (X) IS:
 - 10% OF THE SHORTEST SIDE (PLAN VIEW) BUT NOT LESS THAN 3 FT.
- THE CORNERS MAY BE TREATED AS PERIMETERS IF THE PARAPET IS GREATER THAN OR EQUAL TO 3 FT ON ALL SIDES ACCORDING TO ASCE-7.
- IF ANY PORTION OF THE BOARD LIES IN A PERIMETER OR CORNER ZONE, ENHANCE THE FASTENING OF ENTIRE BOARD.

INSTALLATION NOTES:

- A. ALL INSULATION/COVER BOARDS SHOULD BE 4'-0" x 4'-0".
- B. WHEN APPLYING MULTIPLE LAYERS OF INSULATION, IT IS REQUIRED TO RUN THE BEADS PERPENDICULAR TO THE PRECEDING LAYER. IT IS OPTIONAL WHEN USING WITH JM 2-PART URETHANE ADHESIVE.

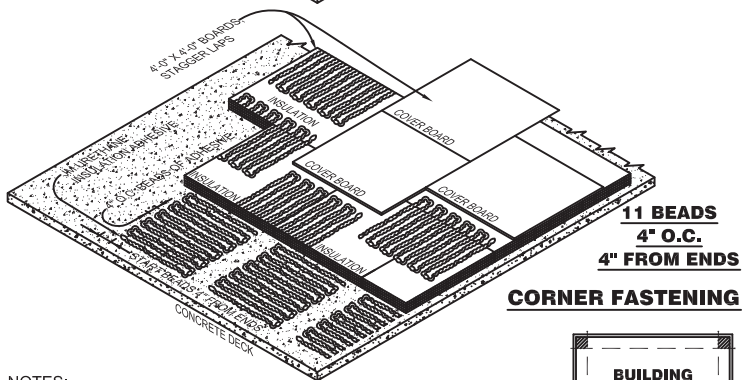
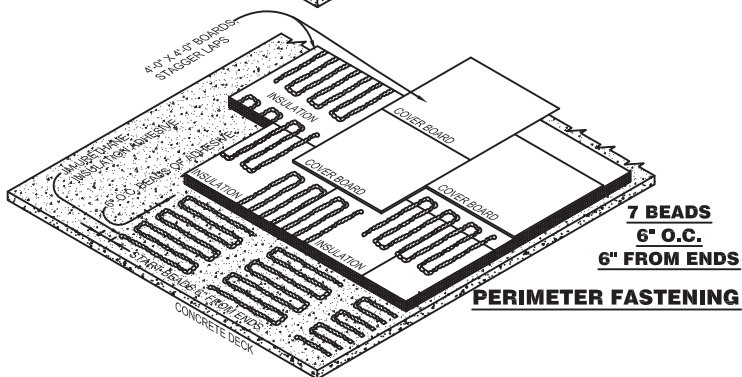
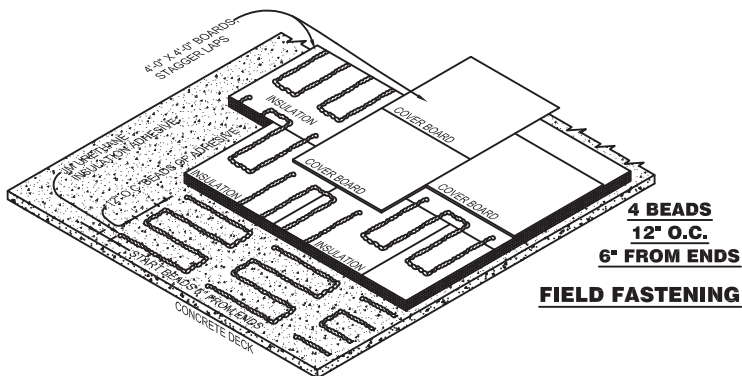

NOTES:

1. UPLIFT DESIGN SHOULD BE IN ACCORDANCE WITH ASCE-7.
2. UPLIFT RESISTANCE SHOWN IS BASED ON FMG 1-29 REQUIREMENTS AND RECOMMENDATIONS.
3. SYSTEM COMPONENTS AND DESIGN MUST BE VERIFIED TO BE IN ACCORDANCE WITH THIS LAYOUT.
4. ASCE-7 DEFINES THE PERIMETER (X) AS THE LESSER OF 10% OF LEAST HORIZONTAL DIMENSION OR .4 x THE HEIGHT, BUT NOT LESS THAN 4% OF LEAST HORIZONTAL DIMENSION OR 3 FEET FOR BUILDINGS UNDER 60 FT. IN HEIGHT. OVER 60 FEET IN HEIGHT, ASCE-7 DEFINES THE PERIMETER (X) AS THE LESSER OF 10% OF LEAST HORIZONTAL DIMENSION ONLY.
5. THE CORNERS MAY BE TREATED AS PERIMETERS IF THE PARAPET IS GREATER THAN OR EQUAL TO 3 FEET ACCORDING TO ASCE-7.

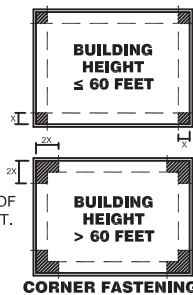

INSTALLATION NOTES:

- A. ALL INSULATION/COVER BOARDS SHOULD BE 4'-0" x 4'-0".
- B. WHEN APPLYING MULTIPLE LAYERS OF INSULATION, IT IS REQUIRED TO RUN THE BEADS PERPENDICULAR TO THE PRECEDING LAYER WHEN USING 1-PART JM URETHANE ADHESIVE. IT IS OPTIONAL WITH JM 2-PART URETHANE ADHESIVE.

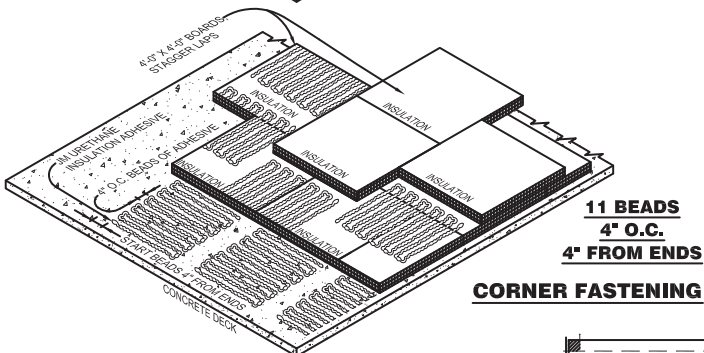
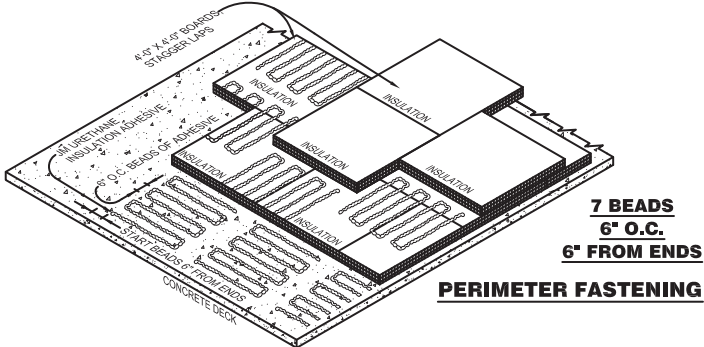
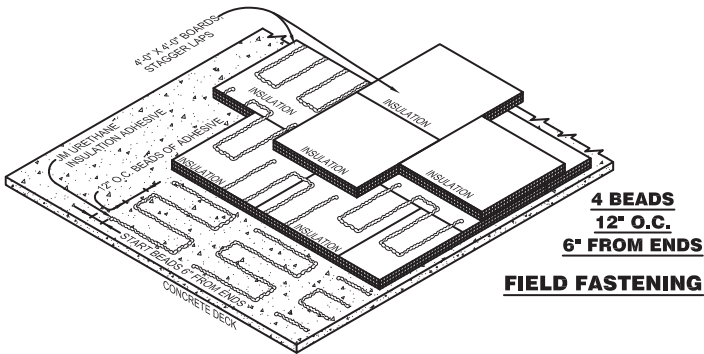

NOTES:

1. UPLIFT DESIGN SHOULD BE IN ACCORDANCE WITH ASCE-7.
2. UPLIFT RESISTANCE SHOWN IS BASED ON FMG 1-29 REQUIREMENTS AND RECOMMENDATIONS.
3. SYSTEM COMPONENTS AND DESIGN MUST BE VERIFIED TO BE IN ACCORDANCE WITH THIS LAYOUT.
4. ASCE-7 DEFINES THE PERIMETER (X) AS THE LESSER OF 10% OF LEAST HORIZONTAL DIMENSION OR .4 x THE HEIGHT, BUT NOT LESS THAN 4% OF LEAST HORIZONTAL DIMENSION OR 3 FEET FOR BUILDINGS UNDER 60 FT. IN HEIGHT. OVER 60 FEET IN HEIGHT, ASCE-7 DEFINES THE PERIMETER (X) AS THE LESSER OF 10% OF LEAST HORIZONTAL DIMENSION ONLY.
5. THE CORNERS MAY BE TREATED AS PERIMETERS IF THE PARAPET IS GREATER THAN OR EQUAL TO 3 FEET ACCORDING TO ASCE-7.

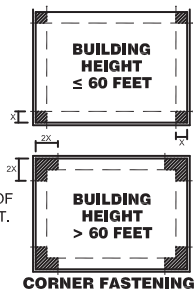

2A

APP Heat-Welded Application Guide

Section Two Contents

1.0	<i>General Information</i>	2-1
2.0	<i>Membrane Substrate</i>	2-2
3.0	<i>Roofing Over Non-nailable Decks</i>	2-2
4.0	<i>Roofing Over Nailable Decks</i>	2-2
5.0	<i>General Guidelines for Application of Materials</i>	2-2
6.0	<i>Roofing Felts</i>	2-3
7.0	<i>Heat-Weld Application</i>	2-3
8.0	<i>Health and Safety</i>	2-4
9.0	<i>Steep Slope Requirements – Heat Welded Systems</i>	2-4
10.0	<i>Phase Construction</i>	2-5
11.0	<i>Cold Weather Application</i>	2-5
12.0	<i>Temporary Roof Coverings</i>	2-6
13.0	<i>Protected Roofing Membrane Assemblies (PRMA)</i>	2-7
14.0	<i>Safety Guidelines for Heat-welded Modified Bitumen</i>	2-9

1.0 General Information

1.1 This section provides application information, and outlines specifications currently available from Johns Manville (JM) Roofing Systems, for APP (Atactic Polypropylene) modified bitumen roofing products. APP modified bitumen products may be installed by heat welding and select products in JM MBR Cold Application Adhesive.

Note: For the most current information on general guidelines, please refer to the **System Considerations** tab under **Systems Introduction & Selection** on the **JM Roofing Web site**. For specifications, flashing details and general installation information please refer to the **System Application** tab.

1.2 All general information contained in this section and the current Johns Manville Commercial/Industrial Roofing Systems Manual should be considered part of these specifications.

1.3 Specifications are available for systems installed over insulation, nailable, non-nailable and lightweight insulating fill substrates. JM offers systems that can be installed by heat welding or in JM MBR Cold Application Adhesive.

1.4 For heat-weld application, all safety procedures must be reviewed prior to application. **All contractors must understand, review and adhere to the information contained in the following sources:**

Johns Manville Safety Guidelines for Heat Weld Application

ARMA Guide to Torch Safety

ARMA Torch Safety Video

1.5 JM does not recommend the use of traditional asphalt cut-back mastics under any APP modified bitumen product. The use of cutback mastics over the modified bitumen product (e.g., to strip in the edges of a base flashing) is acceptable. JM has developed two adhesives — MBR Cold Application Adhesive and MBR Utility Cement — that are compatible with all of the JM APP bitumen products. They should be used whenever a cold adhesive application is necessary or preferred.

1.6 Each specification in this section is eligible to receive a JM Peak Advantage Guarantee. Refer to the information on guarantees in the current JM Commercial/Industrial Roofing Systems Manual, or contact a JM representative for additional information.

1.6.1 This manual clearly differentiates between **requirements** and **recommendations**. This manual has been written to assist the specifier to develop a comprehensive bid package. The information is presented in an explanatory fashion rather than the authoritative, instructive manner commonly utilized in construction specifications. When experience, technical knowledge or established testing procedures support a policy or position, it is clearly identified, (i.e., “**JM requires**” or “is not acceptable”). When the use of a particular product or practice is desirable, the reference is stated as an opinion rather than an absolute fact (i.e., “**JM recommends**” or JM suggests”). **It is mandatory that all requirements be complied with; however, it may not be necessary to follow all recommendations to qualify for a guarantee.**

1.7 Drainage of water off any roof membrane is necessary to prolong the service life of the system. JM, therefore, has the following policy:

Drainage: Design and installation of the deck and/or substrate must result in the roof draining freely and to outlets numerous enough and so located as to remove water promptly and completely. Areas where water ponds for more than 48 hours are unacceptable and will not be eligible for a JM Peak Advantage Guarantee.

1.8 Flashings: Refer to Section 4 of this book for Flashing Specifications and Details.

2.0 Membrane Substrate

2.1 The surface on which the APP modified bitumen roofing membrane is to be applied should be one of the following JM products: DuraBoard, JM APP Base Sheet, Ventsulation Felt, DuraFoam, PermaPly 28 or an approved structural substrate. GlasPly Premier and GlasPly IV may be used in selected specifications. (See “Roof Finder Index,” in Section 3 of this book.) The surface must be clean, smooth, flat and dry.

3.0 Roofing Over Non-Nailable Decks

3.1 These specifications are for use over any type of structural deck which is not nailable, and which offers a suitable surface to receive the roof. Poured and precast concrete decks require priming with Asphalt Primer prior to the application of hot asphalt.

3.2 These specifications are also for use over JM roof insulations – DuraBoard, Fesco Board, Tapered Fesco Board, DuraFoam, Fesco Foam, Tapered Fesco Foam, ENRGY 3, Tapered ENRGY 3 and ½” (13 mm) Retro-Fit Board or other insulations that offer a suitable surface to receive the roof. **For heat-weld application directly to the insulation, the top layer of insulation must be DuraBoard or DuraFoam.**

3.3 These specifications are denoted by an “I” as the third character in the specification designation (e.g., 3CIN-W). See the “Roof Finder Index” in Section 3 of this book for further information.

4.0 Roofing Over Nailable Decks

4.1 These specifications are for use over any type of structural deck (without insulation) which can receive and adequately retain nails or other types of mechanical fasteners recommended by the deck manufacturer. Examples of such decks are wood and plywood. Certain specifications are eligible for use over lightweight insulating concrete decks or over fill made of lightweight insulating concrete. Consult the “Roof Decks” section of the current JM Commercial/Industrial Roofing Systems Manual, or contact a JM Technical Services Specialist for approval of the lightweight concrete to be used.

4.2 Nailable specifications are denoted by an “N” or an “L” as the third character in the specification designation (e.g., 3CNN-W or 3PLN-W). See the “Roof Finder Index” in Section 3 of this book for more information.

4.3 Over wood board decks, one ply of sheathing paper must be used under the base felt, next to the deck. Sheathing paper is not required on plywood decks.

4.4 All of the specifications in this section require the use of a nailable base felt. Use nails or fasteners appropriate to the type of deck. See the “Roof Decks” section of the current JM Commercial/ Industrial Roofing Systems Manual.

5.0 General Guidelines for Application of Materials

5.1 The proper application of roofing materials is as important to the satisfactory performance of the roofing system as the materials themselves. JM strongly recommends the following guidelines for the application of APP modified bitumen roofing materials be followed. **Always follow all recommended safety procedures when applying any heat-welded product.**

- A. Never use wet or damaged materials.
- B. Never apply any roofing materials during rain or snow, or to wet surfaces. Moisture

trapped within the roofing system may cause severe damage to the roofing membrane, insulation and deck.

- C. Take special care when applying any APP modified bitumen in cold weather (below 40°F [4°C]). All rolls must be stored on end in a heated trailer or building. Only rolls needed for immediate application should be exposed to ambient conditions.
- D. Never throw or drop rolls of APP in cold weather; sudden shocks can cause cracking of the APP coating asphalt.
- E. Do not double stack (with or without pallets) in cold weather.
- F. Remove all packaging from product and dispose of properly. Be sure to have the appropriate side of the product in position to be heat welded (polyolefin side down).
- G. APP modified bitumen sheets shall be rolled or scrolled into place as they are heat welded.
- H. Do not use traditional cut-back asphalt cements under APP modified bitumen products. The use of these mastics over the top of APP products is acceptable; however, the MBR cement products are preferred.
- I. Install the entire roofing system at one time. Phased construction may result in blisters due to entrapment of moisture, as well as poor adhesion due to dust or foreign materials that have collected on the exposed felts of an incomplete roofing system.
- J. All smooth APP-surfaced products must be coated with a JM-approved coating. Acceptable roof coatings for APP systems may be found in the built-up roofing Paragraph 6.9 of Section 3b.
- K. **Always comply with published safety procedures for all products being used. See the "Introduction" section of the current JM Commercial/Industrial Roofing Systems Manual, MSDS and container labels for health and safety recommendations.**

6.0 Roofing Felts

6.1 JM manufactures different products for a variety of roofing needs: membranes, flashing, venting and vapor retarders.

6.2 Roofing felts are furnished in rolls consisting typically of one square. Flashing materials are sold in square feet.

7.0 Heat-Weld Application

7.1 The surface over which the APP membrane is to be installed must be firm, dry, smooth, flat and free of debris and loose material. All surfaces must be designed and installed in accordance with manufacturer's, industry and acceptable association standards.

7.2 Drainage: Design and installation of the deck and/or the substrate must result in the roof draining freely and to outlets numerous enough and so located as to remove water promptly and completely. Areas where water ponds for more than 48 hours are unacceptable and will not be eligible for a JM Peak Advantage Guarantee.

7.3 Roofing shall commence at the lowest point of the roof deck with laps installed so that water flows over and not against the lap. Align the roll in the course to be followed and unroll completely. Then reroll both ends to the middle of the roll (scrolling). Using the heat-welding apparatus, apply the heat to the surface of the coiled portion of the roll until the surface reaches the proper application temperature (approximately 330°F [166°C]). The flame should be moved from side to side and the membrane slowly unrolled while pressing the heated portion of the roll into the underlying surface.

Apply the heat across the full width of the roll and along the 4" (102 mm) side lap area of the previously installed roll, making an "L" shape. As the surface of the roll is heated, it will develop a sheen. The generation of smoke is an indication that the material is being overheated. Repeat the operation with subsequent rolls, while maintaining a 4"

(102 mm) side lap and a 6" (152 mm) end lap. On mineral-surfaced membranes, prior to seaming the 6" (152 mm) end lap, the granules must be embedded by heating the end lap area and then pressing the granules into the compound using a rounded-point trowel or an embedding tool. All laps should be rolled with a lap roller and a 1/8" (3 mm) to 3/8" (10 mm) bleed out of APP compound should extend beyond the lap. Check all laps for proper adhesion. Caution: Never adhere APP products with hot asphalt.

8.0 Health and Safety

8.1 J M develops and maintains Material Safety Data Sheets (MSDS) for all of its products. These MSDS contain health and safety information for development of appropriate product handling procedures to protect the users of our products. These sheets are available on the JM Web site (www.jm.com). They should be read and understood by all involved personnel prior to using and handling JM materials. In addition to the MSDS, JM products have health and safety precautions printed on the product label or packaging. The user is strongly urged to familiarize himself with this information prior to using the product, and observe certain precautions during use.

9.0 Steep Slope Requirements – Heat Welded Systems

9.1 Heat-welded APP roofing membranes can be applied on inclines up to 6" per ft (500 mm/m) when proper precautions are taken. On non-nailable decks, wood nailers must be used. Nailers act as insulation stops for the roof insulation and as a facility to back nail the membrane.

On slopes up to 2 1/2" per ft (208 mm/m), the roofing sheets may be installed either perpendicular or parallel to the roof incline.

9.2 Non-nailable Decks: On decks with a slope over 2 1/2" per ft (208 mm/m), the roofing felts must be installed parallel to the incline and must be back nailed. Pressure-treated wood nailers shall be attached to the deck, run perpendicular to the incline, be capable of retaining the nails securing the roofing sheets, have the same thickness as the insulation and be at least 3 1/2" (89 mm) wide. They should be securely attached to the deck with mechanical fasteners to resist a pullout force of 200 pounds (890 N). Wood nailers shall be provided at the ridge and at the following approximate intermediate points:

Incline (Inches/Foot)	Nailer Spacing (D) ¹
0" - 2 1/2" (0-208 mm/m)	Not required
2 1/2" - 6" (208-500 mm/m)	32" (9.8 m) (max.) face-to-face

9.3 Nail the modified bitumen cap sheet at the end lap across the width of the sheet, with the first nail spaced 3/4" (19 mm) from the leading edge of the sheet, and the remaining nails spaced approximately 8 1/2" (216 mm) o.c. The nails shall be staggered across the width of the nailer to reduce the risk of the sheet tearing along the nail line. Nails must have an integral 1" (25 mm) (min.) diameter cap. Where capped nails are not used, fasteners must be driven through caps having a 1" (25 mm) (min.) diameter. All nails are to be covered by the lap of the next sheet.

9.4 Nailers must also be used around the roof perimeter, openings and penetrations, for nailing felts, gravel stops, roof fixtures and fascia systems.

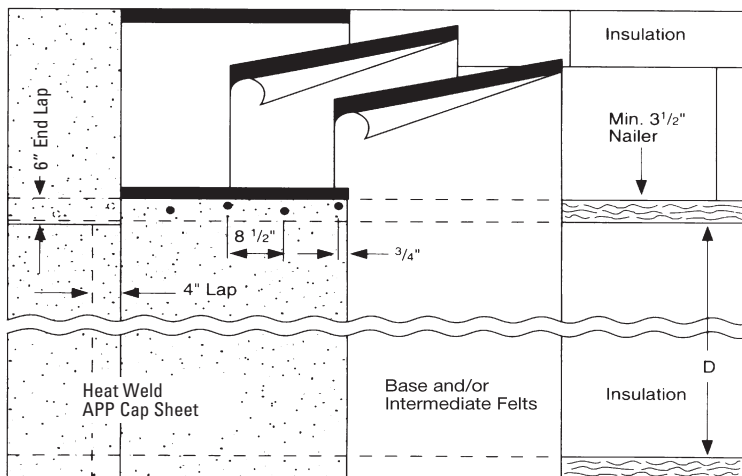

9.5 Nailable and Lightweight Concrete Decks: On decks with a slope over 2 1/2" per ft (208 mm/m), the roofing felts must be installed parallel to the incline. Nail the end laps of the modified bitumen cap sheet across the width of the sheet on 8 1/2" (216 mm) centers. All nails are to be covered by the lap of the next sheet.

10.0 Phase Construction

10.1 One of the greatest hazards of roof construction is the application of a roofing system in "phases," where a partially completed roof system is left exposed to the weather overnight or longer. This can lead to entrapped moisture which can cause premature failure of the membrane.

10.2 When the installation of the cap sheet is delayed for any reason, the following procedures should be followed:

- A. Prior to the application of the modified bitumen cap sheet, the surface of the membrane must be examined thoroughly for the presence of any moisture. If moisture is present, the application of the cap sheet is not to proceed until the moisture has been removed or evaporated and the surface is dry.
- B. The surface of the membrane must be properly cleaned and primed if contaminated by dirt, dust or debris. The primer must be completely dry prior to installation of the modified bitumen cap sheet.

10.3 Under no circumstances shall the installation of the modified bitumen cap sheet be delayed more than 5 days after completion of the intermediate plies of the roofing system.

10.4 Only multiple felt (two felts with modified cap sheet) should be considered for the delay in application of the modified bitumen cap sheet. Single ply felt or base felt systems must receive the modified bitumen cap sheet on the same day.

11.0 Cold Weather Application

11.1 APP modified bitumens require special application techniques when they are being installed in cold weather. The following precautions shall be taken when the ambient temperature drops below 50°F (10°C), and are mandatory below 40°F (4°C):

- A. Modified bitumen products shall be kept warm, or warmed prior to installation. Store these materials indoors or in heated storage units or warming boxes. If these facilities are not available, placing the materials in direct sunlight may help. Make certain that modified bitumen rolls are stored on end only; do not store rolls on their side.
- B. When the conditions are extreme (below 40°F [4°C]), the rolls must be heated or completely unwound and allowed to warm on the roof for 15 to 20 minutes. This shall be done with the darker side of the sheet up. The sheet may then be installed using conventional application techniques.
- C. When the ambient temperature is below 40°F (4°C), extra care must be used when handling and storing APP modified products. During cold weather, these modified bitumen products must be stored on end in a heated trailer or building, and only the rolls needed for immediate application should be outside. Materials must be kept dry. Never throw or drop rolls of modified bitumen products during cold weather. Sudden shocks can cause cracking of the asphalt. **DO NOT DOUBLE STACK** (with or without pallets). For heat-weld applied products, heat the substrate prior to rolling the molten modified bitumen into place. Special attention should be given to the lap area so proper adhesion can be obtained.
- D. The adhesive can be installed in temperatures between 40°F and 100°F (4°C and 38°C). However, when the temperature is below 50°F (10°C), the adhesive must be stored in a warm area (approximately 70°F [21°C]), for 24 hours before being used, to facilitate spreading. Note: Temperature affects the cure rate of the adhesive. Even in cooler weather, the product will develop bond strengths comparable to fully adhered single ply systems in a relatively short time. The membrane ultimately will develop adhesive bonds that exceed those of systems using asphalt as the adhesive.

12.0 Temporary Roof Coverings

12.1 At times, an owner or general contractor may require the building to be closed at a time when the weather is not conducive to good roof construction, or the roof area may have to be used as a work platform during construction. Historically, this situation has led to phase construction, which has resulted in premature roof failure.

12.2 When the complete roof cannot be installed in one operation, the following procedures are recommended:

A. Nailable Decks:

- 1. Apply one layer of an approved JM base felt, lapping the felt 2" (51 mm), and nailing 9" (229 mm) o.c. along the lap and 12" (305 mm) o.c. through the center of the sheet. (Sheathing paper should first be installed on wood board decks.)
- 2. Mop one ply of an approved JM ply felt in ASTM D 312, Type III asphalt and apply a glaze coat of 10 - 15 lb/100 ft² (0.49 - 0.73 kg/m²) of Type III asphalt.
- 3. An alternate would be to heat weld one layer of an APP modified bitumen cap sheet (smooth or mineral surfaced) over the base felt. No glaze coat of asphalt is applied.
- 4. When the permanent roof is to be installed, inspect the roof and remove all damaged and blistered areas. Apply a layer of approved JM base felt nailed through the temporary roof and into the deck as the first layer of the roofing system. As an alternate, a layer of approved JM roof insulation may be mechanically fastened (with appropriate fasteners) through the temporary roof into the deck.
- 5. Proceed with installing the appropriate permanent roof specification.

B. Steel Decks:

- 1. Apply a minimum layer of Fesco Board of adequate thickness to the steel deck using appropriate length UltraFast fasteners.
- 2. Install a ply of a JM ply or base felt and an additional ply of fiber glass felt, both in hot steep asphalt.

3. Finish with a 10 - 15 lb/100 ft² (0.49 - 0.73 kg/m²) glaze coat of hot steep asphalt.
 4. When the permanent roof is to be applied, inspect the roof area. If the insulation has not been damaged and is dry, remove any blistered or damaged felt. Prime the temporary roof with Asphalt Primer at the rate of 1 gal/100 ft² (0.4 l/m²) and then solid mop a layer of insulation board to the temporary roof with hot asphalt. Then apply the permanent roof system.
 5. If the membrane and/or roof insulation has been excessively damaged, remove all unusable material and replace.
- C. Non-nailable Decks, Other than Steel:
1. Prepare the deck as would be done for a permanent roof.
 2. Solid mop two plies of approved JM ply felt in hot Type III asphalt.
 3. Finish with a 10 - 15 lb/100 ft² (0.49 - 0.73 kg/m²) glaze coat of Type III asphalt.
 4. When the permanent roof is to be installed, inspect and repair all defects in the temporary roof. Clean the surface of the temporary roof and prime with Asphalt Primer if the surface is unusually worn. Proceed with the installation of the permanent roof.
 5. As an alternate to step 2, spot mop an approved JM base sheet using a mechanical spot mopping machine. Next, solid mop one ply of approved JM ply felt in hot Type III asphalt. When the permanent roof is to be installed, remove the entire temporary roof, prime the deck as required in the "Roof Decks" section of this manual, and proceed with the installation of the permanent roof.

12.3 The decision as to whether or not a temporary roof is to be left in place is a judgment factor that must be made by the building owner or his representative. Although a JM representative may make suggestions in this area, JM will not be responsible for any problems that may develop with the roofing system due to the fact that the temporary roof is left in place.

13.0 Protected Roofing Membrane Assemblies (PRMA)

13.1 General Information. All general information contained in this section and the current JM Commercial/Industrial Roofing Systems Manual shall be considered part of these specifications.

JM APP modified bitumen specifications are eligible for use with protected roofing membrane assemblies. When these specifications are modified, the last digit of the specification designation should be changed to a "P" to denote "Protected" (e.g., 3CIP-W).

Flashings: All flashings must conform to the requirements stated in this section and the current JM Commercial/Industrial Roofing Systems Manual. The flashing material must extend above the top of the extruded polystyrene insulation a minimum of 8" (203 mm). The standard flashing details for modified bitumen roofing can be found in Section 3.

Drainage: Design and installation of the deck and/or roof substrate must result in the roof draining freely, to outlets numerous enough and so located as to remove water promptly and completely. Areas where water ponds for more than 48 hours are unacceptable, and will not be eligible for a JM Roofing System Guarantee.

13.2 When designing a protected membrane roofing system, the designer must make sure that positive drainage exists on the roof. Even though some extruded polystyrene roof insulation products are designed with integral drainage channels, they will retard the flow of water due to the contact between the membrane and the insulation. JM recommends a minimum of ¼" per ft (20.8 mm/m) slope be obtained on the finished roof membrane. This will greatly reduce the amount of water that will be retained against the membrane after a rain.

13.3 Ballast Requirements (for use with extruded polystyrene roof insulation):

13.4 The ballast should be similar to ASTM D 448, Gradation #57. The following gradation is typical:

Passing ½" (13 mm)	10-60%
Passing ¾" (19 mm)	100%

13.5 Ballast is applied at a rate of approximately 10 to 12 lb/ft² (49 - 59 kg/m²) in the field of the roof over a layer of filter fabric. Twenty (20) lb/ft² (97.6 kg/m²) of ballast is required over a 4' (1.22 m) wide area at the roof perimeter and at all penetrations. The following fabrics have been found to be acceptable:

- A. Confil 689H – 3.0 oz./yd. (93.5 g/m) black polyester from International Paper Company.
- B. Rufon P3B – 3.0 oz./yd. (93.5 g/m) black polypropylene from Phillips Fiber Corporation.

13.6 JM makes no claims as to the quality of these products nor their performance when exposed on the roof. See the product warranty supplied by the fabric manufacturer.

13.7 When pavers are used as ballast, the pavers must be placed on supports or pedestals. These supports or pedestals can either be commercially available products or 6" (152 mm) square pieces of JM DynaTred Plus (to give a minimum ½" [13 mm] air space). These supports should be located at the intersection of the corners of the paver blocks, such that where the four corners come together, all rest on the same 6" (152 mm) square piece of DynaTred Plus or pedestal. The ½" (13 mm) air space between the pavers and the insulation will allow moisture vapor to vent to the atmosphere. If the moisture is not allowed to vent to the atmosphere, the top surface of the insulation will begin to absorb water and the thermal performance will be reduced. **ROOF AREAS THAT HAVE PAVERS IN DIRECT CONTACT WITH THE INSULATION ARE EXCLUDED FROM COVERAGE UNDER A JM PEAK ADVANTAGE GUARANTEE, INCLUDING THE THERMAL OVERLAY PORTION OF THE GUARANTEE.**

13.8 The use of pavers in high traffic areas, to and around equipment and other maintenance areas, is strongly recommended.

13.9 It is the owner's and/or specifier's responsibility to determine if the building structure can support the required amount of ballast and still meet the code design requirements for anticipated dead and live loads (including snow, wind, etc.).

13.10 Decks (PRMA)

13.11 Precast slabs and prestressed "T" or "TT" decks require a minimum of one layer of approved JM roof insulation as a leveling course prior to the installation of the roof membrane.

13.12 For lightweight insulating concrete, gypsum decks, etc., consult a JM Technical Services Specialist for specifications and guarantee information.

13.13 For information on roof deck requirements not mentioned here, refer to the "Roof Decks" section of the current JM Commercial/ Industrial Roofing Systems Manual, or contact a JM Technical Services Specialist.

13.14 Warning: Extruded polystyrene insulation is combustible and may constitute a fire hazard if improperly used or installed. It should be adequately protected. Use only as directed by the specific instructions for this product. This material should NEVER be exposed to an open flame or other source of ignition.

13.15 All roof deck systems over which the protected system is installed should provide an adequate fire barrier for the extruded polystyrene insulation.

13.16 For proper protection of plastic foam in storage, consult the National Fire Protection Association (NFPA) standards or the authority having jurisdiction.

13.17 Installing Ballasted PRMA Roof Insulation Over Modified Bitumen Roof Membranes

13.18 The following are general recommendations for installing ballasted PRMA roof insulation over modified bitumen roof membranes.

Materials per 100 ft ² (9.29 m ²) of membrane area	
Insulation	Extruded polystyrene roof insulation 100 ft ² (9.29 m ²) per layer
Fabric	12' wide, 105 ft ² (3.66 m wide, 9.75 m ²)
	10' wide, 106 ft ² (3.05 m wide, 9.84 m ²)
	8' wide, 107 ft ² (2.44 m wide, 9.94 m ²)
Ballast	³ / ₄ " (19 mm) stone or crushed rock, 1,000 - 1,200 lb/100 ft ² (48.8 - 58.6 kg/m ²)*

*Additional ballast is required at the perimeter and at penetrations.

13.19 Insulation: Place extruded polystyrene roof insulation directly on the membrane with channel side down. The insulation boards should be tightly butted together. The maximum allowable gap between boards is 3/8" (10 mm). The boards shall be installed to within approximately 3/4" (19 mm) of all projections and cant strips.

13.20 For multilayer installations, install subsequent layers, unattached over the first layer. Stagger all joints in relation to the underlying layer. The bottom layer in multi-layer applications must be at least 2" (51 mm) thick and as thick or thicker than the top layer.

13.21 Fabric: Loose lay an approved fabric over the extruded polystyrene roof insulation, with all joints lapped a minimum of 12" (305 mm). There should not be any end laps within 6' (1.83 m) of the perimeter. The fabric should extend 2" to 3" (51 - 76 mm) above the stone at the perimeter and at penetrations.

13.22 Wetting the fabric is helpful in holding it in place on the insulation until the ballast is installed.

13.23 Ballast: Apply the correct size ballast at the rate of 1,000 - 1,200 lb/100 ft² (10 - 12 lb/ft² [48.8 - 58.6 kg/m²]), over the fabric, as the fabric is being laid out in the field of the roof. For a width of 4' (1.22 m) at the roof perimeter or penetrations, install ballast at a rate of 20 lb/ft² (98 kg/m²) or pavers at a rate of 22 lb/lin ft (32.7 kg/lin m). If pavers are used, the fabric is not required. Pavers must be placed on pedestals. Pedestals can be either commercially available products or 6" (152 mm) square pieces of JM DynaTred Plus.

13.24 Ballast should be washed 3/4" (19 mm) gravel or crushed stone, with fines (smaller than 1/2" [13 mm]) accounting for not less than 10% or more than 60%. This gradation is similar to ASTM D 448, Gradation #57.

14.0 Safety Guidelines for Heat-welded Modified Bitumen

14.1 Heat-welded modified bitumen products require special safety precautions prior to, during and after installation. When working with an open flame, contractors must use extra care and extreme caution to prevent accidents. Carelessness can lead to loss of life, injury and loss of property. The following safety recommendations should be followed:

1. All contractors must be licensed and insured in the geographic area where they will conduct business. The work area must be properly prepared before the welding process begins and weather conditions must be favorable. Procedures and equipment must comply with all applicable code requirements including guidelines mandated by the Occupational Safety and Health Administration (OSHA).
2. The roofing contractor must ensure that all mechanics or applicators involved with

the application of heat welded modified bitumens are properly trained not only in application and equipment handling, but also safety measures. The contractor should verify that all roofing applicators involved with open flame application maintain and carry a valid **Certified Roofing Torch Applicator (CERTA)** card as evidence of proper training. Further, the general contractor, jobsite superintendents and the building owner or its representative must also be knowledgeable and/or advised of the proper and necessary safety precautions applicable to heat welded roofing products.

- All mechanics or applicators must carry, review, understand and adhere to the safety information and guidelines contained in "Torch Applied/Do's and Don'ts" as published and supplied by the Asphalt Roofing Manufacturers Association (ARMA) which may be supplemented or amended, as well as the ARMA/NRCA "Guide to Torch Safety on Modified Bitumen" videotape. These are available from ARMA at: ARMA, 4041 Powder Mill Road, Ste. 404, Calverton, MD 20705-3016 (Ph. 301-348-2002). Do not begin application procedures until you read and fully understand these safety procedures and installation practices.**
- Written notice must be given to the local fire department where required and any required or necessary permits must be obtained. Even if not required, it is always recommended to give notice to the fire department, particularly when using LP gas.
- Supervisors must ensure that all roofing applicators wear adequate protective equipment, including nonsynthetic long-sleeved shirts, boots, long pants with no cuffs that extend over the top of the boot, heat-resistant gloves, safety glasses and a face shield during application.
- Never heat weld directly to, or near (e.g., the 35' [10.67 m] rule) combustible materials or surfaces. Extra care must be taken to identify all potentially combustible and flammable material and similar combustible and flammable aspects of a building's use and design. Be aware of insulation type, parapet walls, curbs, cants, wood, edge strips, expansion joints, electrical wires and conduits, gas lines, chemicals, grease, oil, vapors, exhausts, spills or other materials that could ignite. Combustible materials present on a roof must be moved and materials that are not moveable must be protected from the heat-weld process and other fire hazards with fire blankets or shields. Be sure to identify similar materials on adjoining buildings and exercise proper precautions. A fiber glass base sheet should be installed to minimize the risk of fire. Always use combustion-resistant cant strips or other fire-resistant materials.
- Never heat weld near or into vents, openings or cracks around edges, corners, voids or other penetrations in the building or near any rooftop equipment. Shut off fans and cover openings.
- Never leave lighted torches unattended.
- Use only equipment that is specifically designed for heat-welded roofing applications, and be sure the equipment is listed by a nationally recognized independent testing laboratory. The equipment must be operated in accordance with the manufacturer's instructions and in accordance with all applicable codes and regulations. All mechanics must be properly trained and familiar with all safety precautions in the use and handling of tanks, regulators and LP gas. Be familiar with National Fire Protection Association (NFPA) 58 "**Standard for the Storage and Handling of Liquefied Petroleum Gases**" and appropriate publications of the National Propane Gas Association, (NPGA) 1600 Eisenhower Lane, Ste. 100, Lisle, IL 60532 (Ph. 630-515-0600), and the National Fire Protection Association, 11 Tracy Dr., Avon, MA 02322 (Ph. 800- 344-3555). Do not work in areas where LP gas can accumulate. Proper ventilation in accordance with OSHA and the National Institute for Occupational Safety and Health (NIOSH) is required. Ensure that all equipment is in good working condition and inspected daily.
- Maintain at least one fully charged 20 lb (9.1 kg) (min.) ABC-type dry chemical fire

extinguisher for each roofing mechanic on the project, and have more available near the application area (e.g. within 50' [15.24 m]) based on jobsite conditions. Roofing mechanics must have fire extinguisher use training at least annually per OSHA 29 CFR1910.157.

11. Follow fire protection and prevention procedures mandated or recommended by OSHA and/or the National Roofing Contractors Association (NRCA) and ensure compliance with all other federal, state and local regulations, including but not limited to those listed in OSHA 29 CFR1962.1 150, 152.1, 153 and 191-110 as they apply to heat-weld application.
12. A fire watch of sufficient length must be kept during and after all heat welding is completed. A fire watch is never shorter than 1 hour after all application has been completed for a given day. A fire watch may need to be longer depending on the size of the roofing project and the design or configuration of the building. Special attention should be given to potential hot spots or smoldering material, such as carts, wall flashings and around penetrations, rooftop equipment and the roof perimeter. The person performing the fire watch should use an infrared heat-sensing device to detect hot spots and smoldering materials. For more information, contact the NFPA. Should fire result, take immediate, appropriate action; notify the owner of fire response.
13. Remember, it is the contractor's responsibility to observe all fire prevention and safety policies and practices during the installation of the roof system, as well as provide training to their personnel for proper roofing and safety practices as well as responding to emergency situations at the job site. Always keep a first aid kit on the job site; individuals administering first aid must be properly qualified per OSHA 29 CFR1910.151(b).

JOHNS MANVILLE DOES NOT SUPERVISE BUILDING OWNERS, CONTRACTORS, MECHANICS OR ANY OTHER PERSON IN THE APPLICATION OF HEAT-WELDED APPLIED MODIFIED BITUMENS AND ASSUMES NO RESPONSIBILITY FOR FIRE DAMAGE OR ANY OTHER DAMAGES.

2B

APP Modified Bitumen Cold-Applied Application Guide

Section Two Contents

1.0	<i>General Information</i>	2-13
2.0	<i>Membrane Substrate</i>	2-14
3.0	<i>Roofing Over Non-nailable Decks</i>	2-14
4.0	<i>Roofing Over Nailable Decks</i>	2-14
5.0	<i>General Guidelines for Application of Materials</i>	2-14
6.0	<i>Roofing Felts</i>	2-15
7.0	<i>Cold Adhesive Application</i>	2-15
8.0	<i>Health and Safety</i>	2-16
9.0	<i>One-part Cold Adhesive Application</i>	2-16
10.0	<i>One-Part Cold Adhesive Membrane Specifications</i>	2-16
11.0	<i>Steep Slope Requirements – Systems Incorporating Asphalt or Adhesive</i>	2-16
12.0	<i>Phase Construction</i>	2-17
13.0	<i>Cold Weather Application</i>	2-18
14.0	<i>Temporary Roof Coverings</i>	2-18
15.0	<i>Protected Roofing Membrane Assemblies (PRMA)</i>	2-19

1.0 General Information

1.1 This section provides application information, and outlines specifications currently available from Johns Manville (JM) Roofing Systems, for APP (Atactic Polypropylene) modified bitumen roofing products. APP modified bitumen products may be installed by heat welding and select products in JM MBR Cold Application Adhesive.

Note: For the most current information on general guidelines, please refer to the **System Considerations** tab under **Systems Introduction & Selection** on the **JM Roofing Web site**. For specifications, flashing details and general installation information please refer to the **System Application** tab.

1.2 All general instructions contained in this guide book and in the current JM Commercial Roofing Product Manual should be considered part of this specification.

1.3 Specifications are available for systems installed over insulation, nailable, non-nailable and lightweight insulating fill substrates. JM offers systems that can be installed by heat welding or in JM MBR Cold Application Adhesive.

1.4 For heat-weld application, all safety procedures must be reviewed prior to application. **All contractors must understand, review and adhere to the information contained in the following sources:**

Johns Manville Safety Guidelines for Heat Weld Application

ARMA Guide to Torch Safety

ARMA Torch Safety Video

1.5 JM does not recommend the use of traditional asphalt cut-back mastics under any APP modified bitumen product. The use of cutback mastics over the modified bitumen product (e.g., to strip in the edges of a base flashing) is acceptable. JM has developed two adhesives — MBR Cold Application Adhesive and MBR Utility Cement — that are compatible with all of the JM APP bitumen products. They should be used whenever a cold adhesive application is necessary or preferred.

1.6 Each specification in this section is eligible to receive a JM Peak Advantage Guarantee. Refer to the information on guarantees in the current JM Commercial Roofing Product Manual, or contact a JM representative for additional information.

1.6.1 This manual clearly differentiates between **requirements** and **recommendations**. This manual has been written to assist the specifier to develop a comprehensive bid package. The information is presented in an explanatory fashion rather than the authoritative, instructive manner commonly utilized in construction specifications. When experience, technical knowledge or established testing procedures support a policy or position, it is clearly identified, (i.e., “**JM requires**” or “is not acceptable”). When the use of a particular product or practice is desirable, the reference is stated as an opinion rather than an absolute fact (i.e., “**JM recommends**” or JM suggests”). **It is mandatory that all requirements be complied with; however, it may not be necessary to follow all recommendations to qualify for a guarantee.**

1.7 Drainage of water off any roof membrane is necessary to prolong the service life of the system. JM, therefore, has the following policy:

Drainage: Design and installation of the deck and/or substrate must result in the roof draining freely and to outlets numerous enough and so located as to remove water promptly and completely. Areas where water ponds for more than 48 hours are unacceptable and will not be eligible for a JM Peak Advantage Guarantee.

1.8 Flashings: Refer to Section 3 of this book for Flashing Specifications and Details.

2.0 Membrane Substrate

2.1 The surface on which the APP modified bitumen roofing membrane is to be applied should be one of the following JM products: DuraBoard, JM APP Base Sheet, Ventsulation Felt, DuraFoam, PermaPly 28 or an approved structural substrate. GlasPly Premier and GlasPly IV may be used in selected specifications. (See “Roof Finder Index,” in Section 3 of this book.) The surface must be clean, smooth, flat and dry.

3.0 Roofing Over Non-Nailable Decks

3.1 These specifications are for use over any type of structural deck which is not nailable, and which offers a suitable surface to receive the roof. Poured and precast concrete decks require priming with Asphalt Primer prior to the application of hot asphalt.

3.2 These specifications are also for use over JM roof insulations – DuraBoard, Fesco Board, Tapered Fesco Board, DuraFoam, Fesco Foam, Tapered Fesco Foam, ENRGY 3, Tapered ENRGY 3 and ½” (13 mm) Retro-Fit Board or other insulations that offer a suitable surface to receive the roof. **For heat-weld application directly to the insulation, the top layer of insulation must be DuraBoard or DuraFoam. See Book 2 of the JM Commercial Roofing Application Guide for more information.**

3.3 These specifications are denoted by an “I” as the third character in the specification designation (e.g., 2CIN-CA). See the “Roof Finder Index” on page 2-213 of this book for further information.

4.0 Roofing Over Nailable Decks

4.1 These specifications are for use over any type of structural deck (without insulation) which can receive and adequately retain nails or other types of mechanical fasteners recommended by the deck manufacturer. Examples of such decks are wood and plywood. Certain specifications are eligible for use over lightweight insulating concrete decks or over fill made of lightweight insulating concrete. Consult the “Roof Decks” section of the current JM Commercial Roofing Product Manual, or contact a JM Technical Services Specialist for approval of the lightweight concrete to be used.

4.2 Nailable specifications are denoted by an “N” or an “L” as the third character in the specification designation (e.g., 3CLN-CA or 2CNN-CA). See the “Roof Finder Index” on page 2-213 of this book for more information.

4.3 Over wood board decks, one ply of sheathing paper must be used under the base felt, next to the deck. Sheathing paper is not required on plywood decks.

4.4 All of the specifications in this section require the use of a nailable base felt. Use nails or fasteners appropriate to the type of deck. See the “Roof Decks” section of the current JM Commercial Roofing Product Manual.

5.0 General Guidelines for Application of Materials

5.1 The proper application of roofing materials is as important to the satisfactory performance of the roofing system as the materials themselves. JM strongly recommends the following guidelines for the application of APP modified bitumen roofing materials be followed. **Always follow all recommended safety procedures when applying any heat-welded product.**

A. Never use wet or damaged materials.

B. Never apply any roofing materials during rain or snow, or to wet surfaces. Moisture

trapped within the roofing system may cause severe damage to the roofing membrane, insulation and deck.

- C. Take special care when applying any APP modified bitumen in cold weather (below 40°F [4°C]). All rolls must be stored on end in a heated trailer or building. Only rolls needed for immediate application should be exposed to ambient conditions.
- D. Never throw or drop rolls of APP in cold weather; sudden shocks can cause cracking of the APP coating asphalt.
- E. Do not double stack (with or without pallets) in cold weather.
- F. Remove all packaging from product and dispose of properly. Be sure to have the appropriate side of the product in position to be heat welded (polyolefin side down).
- G. APP modified bitumen sheets shall be rolled or scrolled into place as they are heat welded.
- H. Do not use traditional cut-back asphalt cements under APP modified bitumen products. The use of these mastics over the top of APP products is acceptable; however, the MBR cement products are preferred.
- I. Install the entire roofing system at one time. Phased construction may result in blisters due to entrapment of moisture, as well as poor adhesion due to dust or foreign materials that have collected on the exposed felts of an incomplete roofing system.
- J. All smooth APP-surfaced products must be coated with a JM-approved coating. Acceptable roof coatings for APP systems may be found in the built-up roofing Paragraph 6.9 of Section 3b.
- K. **Always comply with published safety procedures for all products being used. See the "Introduction" section of the current JM Commercial Roofing Product Manual, SDS and container labels for health and safety recommendations.**

6.0 Roofing Felts

6.1 JM manufactures different products for a variety of roofing needs: membranes, flashing, venting and vapor retarders.

6.2 Roofing felts are furnished in rolls consisting typically of one square. Flashing materials are sold in square feet.

7.0 Cold Adhesive Application

7.1 There are situations where the use of heat welding and hot asphalt are undesirable or prohibited. In such cases, it may be necessary to use alternative materials such as cold adhesives (typically referred to as "cold process cements" or "cold application cements/adhesives"). JM research and development staff has determined that traditional cut-back asphalt mastics, as well as some of the newer "modified bitumen adhesives," can have an adverse effect on APP modified bitumen products. This is due to the very high levels of solvent used in most of these cements. Softening, blisters and excessive granule loss can occur as the solvent from the cement passes through the membrane. This can cause accelerated aging of the underlying waterproofing with the potential for premature membrane failure.

7.2 Through the evaluation of numerous alternate adhesive systems, JM has developed a viable cold application system for use with APP modified bitumen products.

8.0 Health and Safety

8.1 JM develops and maintains Safety Data Sheets (SDS) for all of its products. These SDS contain health and safety information for development of appropriate product handling procedures to protect the users of our products. These sheets are available on the JM Web site (www.jm.com/roofing). They should be read and understood by all involved personnel prior to using and handling JM materials. In addition to the SDS, JM products have health and safety precautions printed on the product label or packaging. The user is strongly urged to familiarize himself with this information prior to using the product, and observe certain precautions during use.

9.0 One-Part Cold Adhesive Application

9.1 MBR Cold Application Adhesive and MBR Utility Cement are similar in consistency and application to traditional built-up roofing cold process cements. These adhesives form a durable, elastomeric and waterproof layer once cured.

9.2 MBR Cold Application Adhesive is used in the field of the roof and is used to adhere roofing plies, modified bitumen sheets and roof insulation. Fiber glass ply sheets, such as GlasPly Premier and GlasPly IV, cannot be used with this material. The adhesive is ready to use as shipped and does not require mixing. Do not thin with additional solvents.

9.3 The adhesive is applied at a nominal rate of 1½ gal/100 ft² (0.61 l/m²) over nonporous substrates, e.g., primed concrete or fiber glass base felts. If applied to porous materials, such as insulations, the application rate will increase, depending on the absorbency of the material.

9.4 Position several rolls, beginning at the low edge of the work area, and unroll completely. Once the material has had time to relax, reroll the material from both ends (scroll) prior to applying the MBR Cold Application Adhesive.

9.5 The simplest means of adhesive application is by pouring a 2" to 4" (51 mm - 102 mm) wide bead of the adhesive along the substrate, about 12" (305 mm) from the lower edge of the work area. The adhesive is spread with a ¼" (6 mm) (max.) saw-toothed rubber squeegee to obtain a uniform bed of adhesive. (The Roofer-Rite Brand squeegee has been found to work very well for these applications.) Spread the adhesive first toward the lower edge of the work area. Then, continue to spread the adhesive up the roof until the bed of adhesive is wide enough to receive several sheets.

10.0 One-part Cold Adhesive Membrane Specifications

10.1 Refer to page 2-113 of this book for membrane construction recommendations.

11.0 Steep Slope Requirements – Systems Incorporating Asphalt or Adhesive

11.1 APP roofing membranes that incorporate asphalt adhered base/ intermediate felts can be applied on inclines up to 3" per ft (250 mm/m) when proper precautions are taken. On non-nailable decks, wood nailers must be used. Nailers act as insulation stops for the roof insulation and as a facility to nail the membrane.

On slopes up to ½" per ft (42 mm/m), the roofing sheets may be installed either perpendicular or parallel to the roof incline.

11.2 Non-nailable Decks: On decks with a slope over ½" per ft (42 mm/m), the roofing felts must be installed parallel to the incline and must be back nailed. Pressure-treated

wood nailers shall be attached to the deck, run perpendicular to the incline, be capable of retaining the nails securing the roofing sheets, have the same thickness as the insulation and be at least 3½" (89 mm) wide. They should be securely attached to the deck with mechanical fasteners to resist a pullout force of 200 pounds (890 N). Wood nailers shall be provided at the ridge and at the following approximate intermediate points:

Incline (Inches/Foot)	Nailer Spacing (D) ¹	Type of Asphalt
0" -½" (0-41 mm/m)	Not required	Type III or IV*
½" -2" (41-167 mm/m)	32' (9.8 m) (max.) face to face	Type IV
2" -3" (167-250 mm/m)	10' (3.1m) (max.) face to face	Type IV

* Consult with a JM Technical Service Specialist regarding projects in hot climates as Type III asphalt

Nailers may also be laid out to conform to the roll length being used. For slopes between ½" to 2" per ft (42 to 167 mm/m), nailers should be spaced to accommodate full-length modified bitumen rolls. For slopes between 2" to 3" per ft (167 to 250 mm/m), the nailers should be spaced to accommodate half-length rolls.

11.3 Cut the modified bitumen cap sheet to conform to the nailer spacing. Nail the end lap across the width of the sheet, with the first nail spaced ¾" (19 mm) from the leading edge of the sheet, and the remaining nails spaced approximately 8½" (216 mm) o.c. The nails shall be staggered across the width of the nailer to reduce the risk of the sheet tearing along the nail line. Nails must have an integral 1" (25 mm) (min.) diameter cap. Where capped nails are not used, fasteners must be driven through caps having a 1" (25 mm) (min.) diameter. All nails are to be covered by the lap of the next sheet.

11.4 Nailers must also be used around the roof perimeter, openings and penetrations, for nailing felts, gravel stops, roof fixtures and fascia systems.

11.5 Nailable and Lightweight Concrete Decks: On decks with a slope over ½" per ft (42 mm/m), the roofing felts must be installed parallel to the incline. Nail the end laps of the modified bitumen cap sheet across the width of the sheet on 8½" (216 mm) centers. All nails are to be covered by the lap of the next sheet. For slopes from ½" to 2" per ft (42 to 167 mm/m), a full-length sheet can be used. For slopes from 2" to 3" per ft (167 to 250 mm/m), a half-length sheet should be used.

Incline (Inches/Foot)	Type of Asphalt
0" -½" (0-41 mm/m)	Type III or IV*
½" -2" (41-167 mm/m)	Type IV
2" -3" (167-250 mm/m)	Type IV

* Consult with a JM Technical Services Specialist regarding projects in hot climates as Type III asphalt may not be permitted in some areas.

12.0 Phase Construction

12.1 One of the greatest hazards of roof construction is the application of a roofing system in "phases," where a partially completed roof system is left exposed to the weather overnight or longer. This can lead to entrapped moisture which can cause premature failure of the membrane.

12.2 When the installation of the cap sheet is delayed for any reason, the following procedures should be followed:

- A. Prior to the application of the modified bitumen cap sheet, the surface of the membrane must be examined thoroughly for the presence of any moisture. If moisture is present, the application of the cap sheet is not to proceed until the moisture has been removed or evaporated and the surface is dry.

B. The surface of the membrane must be properly cleaned and primed if contaminated by dirt, dust or debris. The primer must be completely dry prior to installation of the modified bitumen cap sheet.

12.3 Under no circumstances shall the installation of the modified bitumen cap sheet be delayed more than 5 days after completion of the intermediate plies of the roofing system.

12.4 Only multiple felt (two felts with modified cap sheet) should be considered for the delay in application of the modified bitumen cap sheet. Single ply felt or base felt systems must receive the modified bitumen cap sheet on the same day.

13.0 Cold Weather Application

13.1 APP modified bitumens require special application techniques when they are being installed in cold weather. The following precautions shall be taken when the ambient temperature drops below 50°F (10°C), and are mandatory below 40°F (4°C):

- A. Modified bitumen products shall be kept warm, or warmed prior to installation. Store these materials indoors or in heated storage units or warming boxes. If these facilities are not available, placing the materials in direct sunlight may help. Make certain that modified bitumen rolls are stored on end only; do not store rolls on their side.
- B. When the conditions are extreme (below 40°F [4°C]), the rolls must be heated or completely unwound and allowed to warm on the roof for 15 to 20 minutes. This shall be done with the darker side of the sheet up. The sheet may then be installed using conventional application techniques.
- C. When the ambient temperature is below 40°F (4°C), extra care must be used when handling and storing APP modified products. During cold weather, these modified bitumen products must be stored on end in a heated trailer or building, and only the rolls needed for immediate application should be outside. Materials must be kept dry. Never throw or drop rolls of modified bitumen products during cold weather. Sudden shocks can cause cracking of the asphalt. **DO NOT DOUBLE STACK** (with or without pallets). For heat-weld applied products, heat the substrate prior to rolling the molten modified bitumen into place. Special attention should be given to the lap area so proper adhesion can be obtained.
- D. The adhesive can be installed in temperatures between 40°F and 100°F (4°C and 38°C). However, when the temperature is below 50°F (10°C), the adhesive must be stored in a warm area (approximately 70°F [21°C]), for 24 hours before being used, to facilitate spreading. Note: Temperature affects the cure rate of the adhesive. Even in cooler weather, the product will develop bond strengths comparable to fully adhered single ply systems in a relatively short time. The membrane ultimately will develop adhesive bonds that exceed those of systems using asphalt as the adhesive.

14.0 Temporary Roof Coverings

14.1 At times, an owner or general contractor may require the building to be closed at a time when the weather is not conducive to good roof construction, or the roof area may have to be used as a work platform during construction. Historically, this situation has led to phase construction, which has resulted in premature roof failure.

14.2 When the complete roof cannot be installed in one operation, the following procedures are recommended:

A. Nailable Decks:

1. Apply one layer of an approved JM base felt, lapping the felt 2" (51 mm), and nailing 9" (229 mm) o.c. along the lap and 12" (305 mm) o.c. through the center of the sheet. (Sheathing paper should first be installed on wood board decks.)
2. Mop one ply of an approved JM ply felt in ASTM D 312, Type III asphalt and apply a glaze coat of 10 - 15 lb/100 ft² (0.49 - 0.73 kg/m²) of Type III asphalt.

3. An alternate would be to heat weld one layer of an APP modified bitumen cap sheet (smooth or mineral surfaced) over the base felt. No glaze coat of asphalt is applied.
 4. When the permanent roof is to be installed, inspect the roof and remove all damaged and blistered areas. Apply a layer of approved JM base felt nailed through the temporary roof and into the deck as the first layer of the roofing system. As an alternate, a layer of approved JM roof insulation may be mechanically fastened (with appropriate fasteners) through the temporary roof into the deck.
 5. Proceed with installing the appropriate permanent roof specification.
- B. Steel Decks:**
1. Apply a minimum layer of Fesco Board of adequate thickness to the steel deck using appropriate length UltraFast fasteners.
 2. Install a ply of a JM ply or base felt and an additional ply of fiber glass felt, both in hot steep asphalt.
 3. Finish with a 10 - 15 lb/100 ft² (0.49 - 0.73 kg/m²) glaze coat of hot steep asphalt.
 4. When the permanent roof is to be applied, inspect the roof area. If the insulation has not been damaged and is dry, remove any blistered or damaged felt. Prime the temporary roof with Asphalt Primer at the rate of 1 gal/100 ft² (0.4 l/m²) and then solid mop a layer of insulation board to the temporary roof with hot asphalt. Then apply the permanent roof system.
 5. If the membrane and/or roof insulation has been excessively damaged, remove all unusable material and replace.
- C. Non-nailable Decks, Other than Steel:**
1. Prepare the deck as would be done for a permanent roof.
 2. Solid mop two plies of approved JM ply felt in hot Type III asphalt.
 3. Finish with a 10 - 15 lb/100 ft² (0.49 - 0.73 kg/m²) glaze coat of Type III asphalt.
 4. When the permanent roof is to be installed, inspect and repair all defects in the temporary roof. Clean the surface of the temporary roof and prime with Asphalt Primer if the surface is unusually worn. Proceed with the installation of the permanent roof.
 5. As an alternate to step 2, spot mop an approved JM base sheet using a mechanical spot mopping machine. Next, solid mop one ply of approved JM ply felt in hot Type III asphalt. When the permanent roof is to be installed, remove the entire temporary roof, prime the deck as required in the "Roof Decks" section of this manual, and proceed with the installation of the permanent roof.

14.3 The decision as to whether or not a temporary roof is to be left in place is a judgment factor that must be made by the building owner or his representative. Although a JM representative may make suggestions in this area, JM will not be responsible for any problems that may develop with the roofing system due to the fact that the temporary roof is left in place.

15.0 Protected Roofing Membrane Assemblies (PRMA)

15.1 General Information. All general information contained in this section and in the current JM Commercial Roofing Product Manual shall be considered part of these specifications.

JM APP modified bitumen specifications are eligible for use with protected roofing membrane assemblies. When these specifications are modified, the last digit of the specification designation should be changed to a "P" to denote "Protected" (e.g., 3CIP-W).

Flashings: All flashings must conform to the requirements stated in this section and in Section 3 of this guide book. The flashing material must extend above the top of the extruded polystyrene insulation a minimum of 8" (203 mm). The standard flashing details for modified bitumen roofing can be found in Section 3.

Drainage: Design and installation of the deck and/or roof substrate must result in the roof draining freely, to outlets numerous enough and so located as to remove water promptly and completely. Areas where water ponds for more than 48 hours are unacceptable, and will not be eligible for a JM Roofing System Guarantee.

15.2 When designing a protected membrane roofing system, the designer must make sure that positive drainage exists on the roof. Even though some extruded polystyrene roof insulation products are designed with integral drainage channels, they will retard the flow of water due to the contact between the membrane and the insulation. JM recommends a minimum of ¼" per ft (20.8 mm/m) slope be obtained on the finished roof membrane. This will greatly reduce the amount of water that will be retained against the membrane after a rain.

15.3 Ballast Requirements (for use with extruded polystyrene roof insulation):

15.4 The ballast should be similar to ASTM D 448, Gradation #57. The following gradation is typical:

Passing ½" (13 mm)	10-60%
Passing ¾" (19 mm)	100%

15.5 Ballast is applied at a rate of approximately 10 to 12 lb/ft² (49 - 59 kg/m²) in the field of the roof over a layer of filter fabric. Twenty (20) lb/ft² (97.6 kg/m²) of ballast is required over a 4' (1.22 m) wide area at the roof perimeter and at all penetrations. The following fabrics have been found to be acceptable:

- A. Confil 689H – 3.0 oz./yd. (93.5 g/m) black polyester from International Paper Company.
- B. Rufon P3B – 3.0 oz./yd. (93.5 g/m) black polypropylene from Phillips Fiber Corporation.

15.6 JM makes no claims as to the quality of these products nor their performance when exposed on the roof. See the product warranty supplied by the fabric manufacturer.

15.7 When pavers are used as ballast, the pavers must be placed on supports or pedestals. These supports or pedestals can either be commercially available products or 6" (152 mm) square pieces of JM DynaTred Plus (to give a minimum ½" [13 mm] air space). These supports should be located at the intersection of the corners of the paver blocks, such that where the four corners come together, all rest on the same 6" (152 mm) square piece of DynaTred Plus or pedestal. The ½" (13 mm) air space between the pavers and the insulation will allow moisture vapor to vent to the atmosphere. If the moisture is not allowed to vent to the atmosphere, the top surface of the insulation will begin to absorb water and the thermal performance will be reduced. **ROOF AREAS THAT HAVE PAVERS IN DIRECT CONTACT WITH THE INSULATION ARE EXCLUDED FROM COVERAGE UNDER A JM PEAK ADVANTAGE GUARANTEE, INCLUDING THE THERMAL OVERLAY PORTION OF THE GUARANTEE.**

15.8 The use of pavers in high traffic areas, to and around equipment and other maintenance areas, is strongly recommended.

15.9 It is the owner's and/or specifier's responsibility to determine if the building structure can support the required amount of ballast and still meet the code design requirements for anticipated dead and live loads (including snow, wind, etc.).

15.10 Decks (PRMA)

15.11 Precast slabs and prestressed "T" or "TT" decks require a minimum of one layer of approved JM roof insulation as a leveling course prior to the installation of the roof membrane.

15.12 For lightweight insulating concrete, gypsum decks, etc., consult a JM Technical Services Specialist for specifications and guarantee information.

15.13 For information on roof deck requirements not mentioned here, refer to the "Roof Decks" section of the current JM Commercial Roofing Product Manual, or contact a

JM Technical Services Specialist.

15.14 Warning: Extruded polystyrene insulation is combustible and may constitute a fire hazard if improperly used or installed. It should be adequately protected. Use only as directed by the specific instructions for this product. This material should NEVER be exposed to an open flame or other source of ignition.

15.15 All roof deck systems over which the protected system is installed should provide an adequate fire barrier for the extruded polystyrene insulation.

15.16 For proper protection of plastic foam in storage, consult the National Fire Protection Association (NFPA) standards or the authority having jurisdiction.

15.17 Installing Ballasted PRMA Roof Insulation Over Modified Bitumen Roof Membranes

15.18 The following are general recommendations for installing ballasted PRMA roof insulation over modified bitumen roof membranes.

Materials per 100 ft ² (9.29 m ²) of membrane area	
Insulation	Extruded polystyrene roof insulation 100 ft ² (9.29 m ²) per layer
Fabric	12' wide, 105 ft ² (3.66 m wide, 9.75 m ²)
	10' wide, 106 ft ² (3.05 m wide, 9.84 m ²) 8' wide, 107 ft ² (2.44 m wide, 9.94 m ²)
Ballast	³ / ₄ " (19 mm) stone or crushed rock, 1,000 - 1,200 lb/100 ft ² (48.8 - 58.6 kg/m ²)*

*Additional ballast is required at the perimeter and at penetrations.

15.19 Insulation: Place extruded polystyrene roof insulation directly on the membrane with channel side down. The insulation boards should be tightly butted together. The maximum allowable gap between boards is ³/₈" (10 mm). The boards shall be installed to within approximately ³/₄" (19 mm) of all projections and cant strips.

15.20 For multilayer installations, install subsequent layers, unattached over the first layer. Stagger all joints in relation to the underlying layer. The bottom layer in multi-layer applications must be at least 2" (51 mm) thick and as thick or thicker than the top layer.

15.21 Fabric: Loose lay an approved fabric over the extruded polystyrene roof insulation, with all joints lapped a minimum of 12" (305 mm). There should not be any end laps within 6' (1.83 m) of the perimeter. The fabric should extend 2" to 3" (51 - 76 mm) above the stone at the perimeter and at penetrations.

15.22 Wetting the fabric is helpful in holding it in place on the insulation until the ballast is installed.

15.23 Ballast: Apply the correct size ballast at the rate of 1,000 - 1,200 lb/100 ft² (10 - 12 lb/ft² [48.8 - 58.6 kg/m²]), over the fabric, as the fabric is being laid out in the field of the roof. For a width of 4' (1.22 m) at the roof perimeter or penetrations, install ballast at a rate of 20 lb/ft² (98 kg/m²) or pavers at a rate of 22 lb/lin ft (32.7 kg/lin m). If pavers are used, the fabric is not required. Pavers must be placed on pedestals. Pedestals can be either commercially available products or 6" (152 mm) square pieces of JM DynaTred Plus.

15.24 Ballast should be washed ³/₄" (19 mm) gravel or crushed stone, with fines (smaller than ¹/₂" [13 mm]) accounting for not less than 10% or more than 60%. This gradation is similar to ASTM D 448, Gradation #57.

3

Mechanically Fastened Base Sheet Fastening Patterns

Fastening Patterns Compatibility Guide and Contents

Description	Pattern Number	APP		BUR		SBS		Page
		CA	HA	CA	HA	CA	HA	
4x2 Ft. Roof Insulation Fastener Placement	-	X	X	X	X	X	X	1-3
4x4 Ft. Roof Insulation Fastener Placement	-	X	X	X	X	X	X	1-4
4x8 Ft. Roof Insulation Fastener Placement	-	X	X	X	X	X	X	1-6
Fully Adhered Cover (8-16-32)	AD-8	X	X	X	X	X	X	1-10
Fully Adhered Cover (16-24-32)	AD-16	X	X	X	X	X	X	1-11
Mechanically Fastened Base Sheet (6" o.c.)	BM-6		X		X		X	3-2
Mechanically Fastened Base Sheet (7", 7" o.c.)	BM-7,7,7	X	X	X	X	X	X	3-3
Mechanically Fastened Base Sheet (7", 9", 9" o.c.)	BM-7,9,9	X	X	X	X	X	X	3-4
Mechanically Fastened Base Sheet (7.5", 7.5", 7.5" o.c.)	BM-7.5,7.5,7.5	X	X	X	X	X	X	3-5
Mechanically Fastened Base Sheet (9", 9", 9" o.c.)	BM-9,9,9	X	X	X	X	X	X	3-6
Mechanically Fastened Base Sheet (9", 12", 12" o.c.)	BM-9,12,12	X	X	X	X			3-7
Mechanically Fastened Base Sheet (9", 18", 18" o.c.)	BM-9,18,18	X	X	X	X	X	X	3-8
Mechanically Fastened Base Sheet (12" o.c.)	BM-12		X		X			3-9
Mechanically Fastened Base Sheet (12", 12", 12" o.c.)	BM-12,12,12	X	X	X	X	X	X	3-10
Mechanically Fastened Base Sheet (18" o.c.)	BM-18		X		X		X	3-11
Mechanically Fastened DynaFast® Base Sheet (18", 12", 6" o.c.)	BM-18, 12, 6					X	X	3-12

Key: HA = Hot Applied CA = Cold Applied MF = Mechanically Fastened FA = Fully Adhered

Note: For the most current information on general guidelines, please refer to the System Considerations tab under Commercial Roofing Products on the JM Roofing Web site. For specifications, flashing details and general installation information please refer to the Application Tools tab.

Refer to the Safe Use Instructions and product label prior to using this product.

Mechanically Fastened Base Sheet Fastening Pattern BM-6

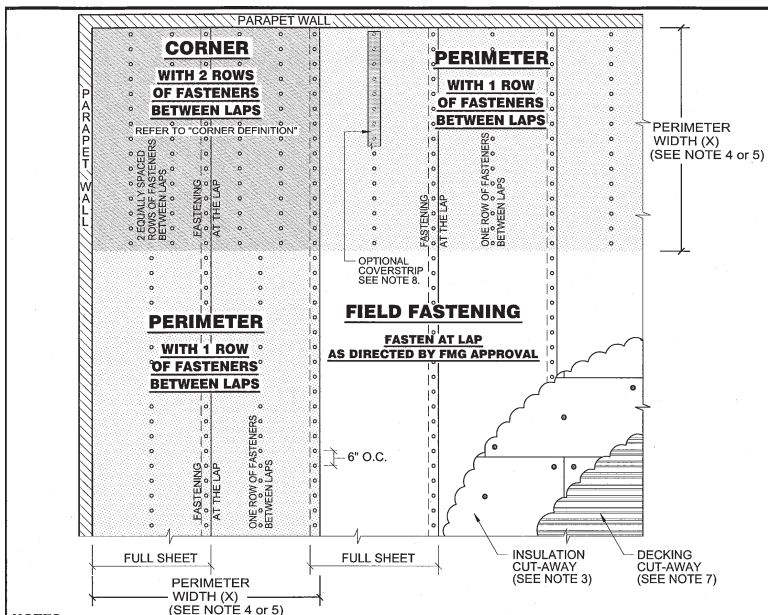

NOTES

- CALCULATE UPLIFT DESIGN PRESSURES IN ACCORDANCE WITH ASCE-7.
- FASTENING DIAGRAM IS BASED ON FM GLOBAL DATA SHEET 1-29.
- INSTALL INSULATION WITH LONG JOINTS IN A CONTINUOUS STRAIGHT LINE WITH END JOINTS STAGGERED.
- ROOF HEIGHT \leq 60 FT, THE PERIMETER (X) IS THE SMALLER DIMENSION OF: 10% OF THE SHORTEST SIDE (PLAN VIEW) OR 40% OF THE ROOF HEIGHT, BUT NOT LESS THAN 4% OF THE SHORTEST SIDE (PLAN VIEW) OR 3 FEET.
- ROOF HEIGHT $>$ 60 FT, THE PERIMETER (X) IS: 10% OF THE SHORTEST SIDE (PLAN VIEW) BUT NOT LESS THAN 3 FEET.
- THE CORNERS MAY BE TREATED AS PERIMETERS IF THE PARAPET IS GREATER THAN OR EQUAL TO 3 FT ON ALL SIDES ACCORDING TO ASCE-7.
- MEMBRANE SIDE LAPS MUST RUN PERPENDICULAR TO METAL DECK FLUTES.
- THE USE OF COVERSTRIPS OVER EXPOSED FASTENERS ALLOW THE FASTENED BASE SHEET TO BE CONSIDERED A WATERPROOFING LAYER.

INSULATION FASTENING

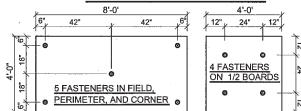

CORNER DEFINITION

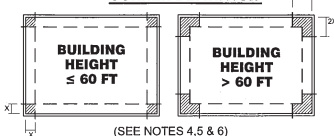

MECHANICALLY ATTACHED BASESHEET (6" O.C.)

DRAWING NO. BM-6	SCALE N.T.S.	ISSUE DATE 1st Sept 09	REV. NO. 1
----------------------------	-----------------	---------------------------	---------------

CAD FILE:
BM_6.dwg

Johns Manville is a Manufacturer of commercial roofing products and offers this general conceptual information to you as a courtesy. This complimentary assistance is not to be used or relied upon by anyone as a substitute for professional engineering design and documentation required by building code, contract, or applicable law. By accepting these comments you agree they do not constitute any representation, endorsement, or an assumption by Johns Manville of any liability for either the adequacy of the design of this building or any other material not supplied by Johns Manville.



Mechanically Fastened Base Sheet Fastening Patterns

SECTION THREE

Note: For the most current information on general guidelines, please refer to the System Considerations tab under Commercial Roofing Products on the JM Roofing Web site. For specifications, flashing details and general installation information please refer to the Application Tools tab.

Refer to the Safe Use Instructions and product label prior to using this product.

Mechanically Fastened Base Sheet Fastening Pattern BM-7,7,7

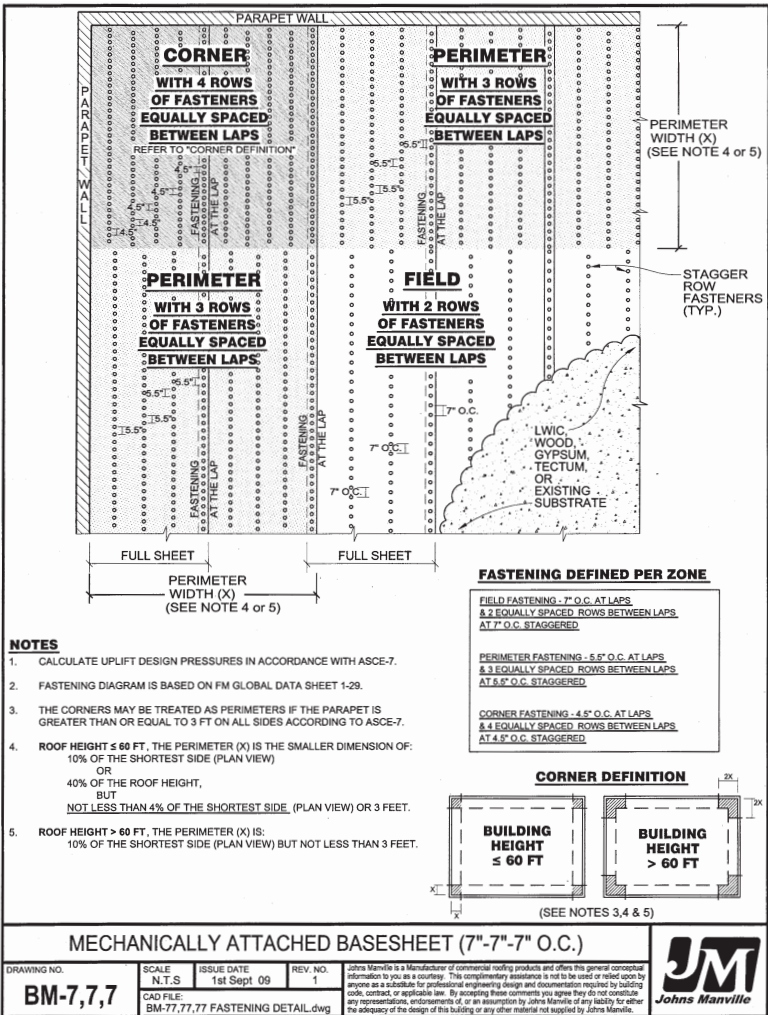

- NOTES**
- CALCULATE UPLIFT DESIGN PRESSURES IN ACCORDANCE WITH ASCE-7.
 - FASTENING DIAGRAM IS BASED ON FM GLOBAL DATA SHEET 1-29.
 - THE CORNERS MAY BE TREATED AS PERIMETERS IF THE PARAPET IS GREATER THAN OR EQUAL TO 3 FT ON ALL SIDES ACCORDING TO ASCE-7.
 - ROOF HEIGHT ≤ 60 FT, THE PERIMETER (X) IS THE SMALLER DIMENSION OF: 10% OF THE SHORTEST SIDE (PLAN VIEW) OR 40% OF THE ROOF HEIGHT, BUT NOT LESS THAN 4% OF THE SHORTEST SIDE, (PLAN VIEW) OR 3 FEET.
 - ROOF HEIGHT > 60 FT, THE PERIMETER (X) IS: 10% OF THE SHORTEST SIDE (PLAN VIEW) BUT NOT LESS THAN 3 FEET.

Mechanically Fastened Base Sheet Fastening Patterns

SECTION THREE

Note: For the most current information on general guidelines, please refer to the System Considerations tab under Commercial Roofing Products on the JM Roofing Web site. For specifications, flashing details and general installation information please refer to the Application Tools tab.

Refer to the Safe Use Instructions and product label prior to using this product.

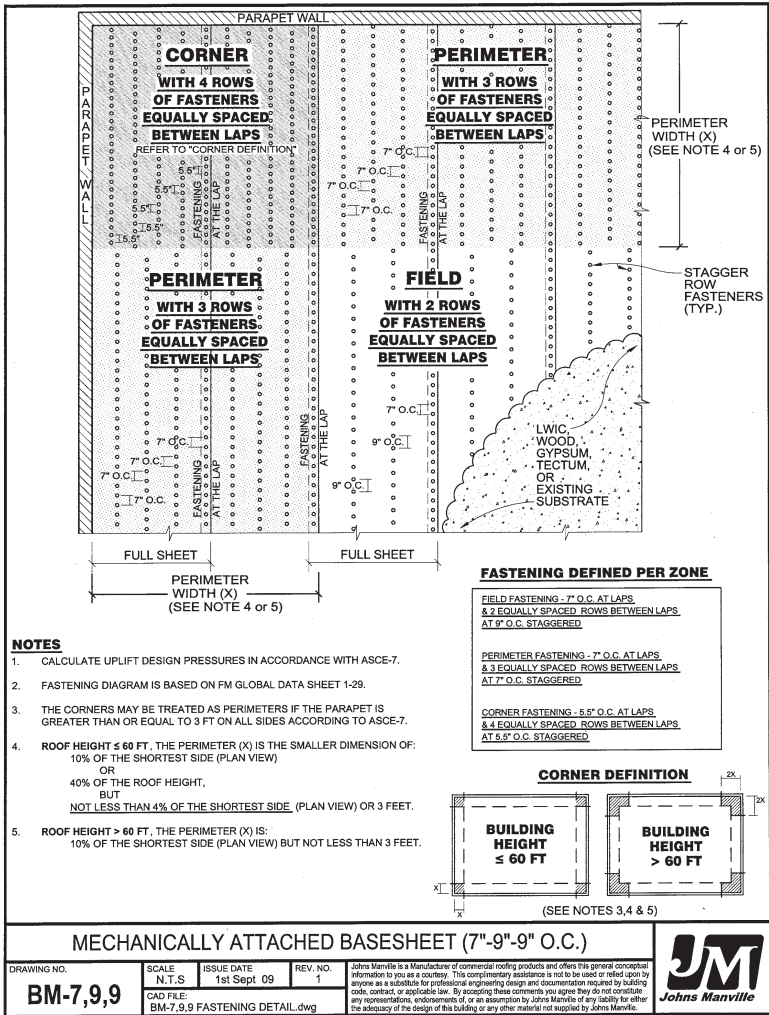

Mechanically Fastened Base Sheet Fastening Patterns

SECTION THREE

Note: For the most current information on general guidelines, please refer to the System Considerations tab under Commercial Roofing Products on the JM Roofing Web site. For specifications, flashing details and general installation information please refer to the Application Tools tab.

Refer to the Safe Use Instructions and product label prior to using this product.

Mechanically Fastened Base Sheet Fastening Pattern BM-75,75,75

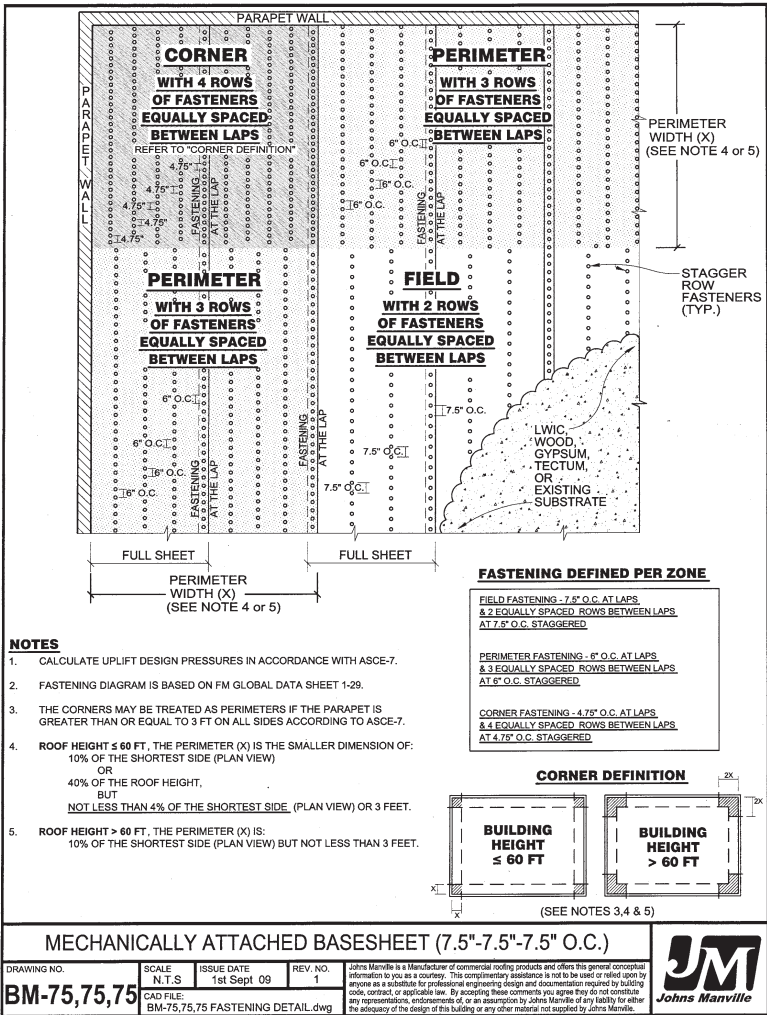

Mechanically Fastened Base Sheet Fastening Patterns

SECTION THREE

Note: For the most current information on general guidelines, please refer to the System Considerations tab under Commercial Roofing Products on the JM Roofing Web site. For specifications, flashing details and general installation information please refer to the Application Tools tab.

Refer to the Safe Use Instructions and product label prior to using this product.

Mechanically Fastened Base Sheet Fastening Pattern BM-9,9,9

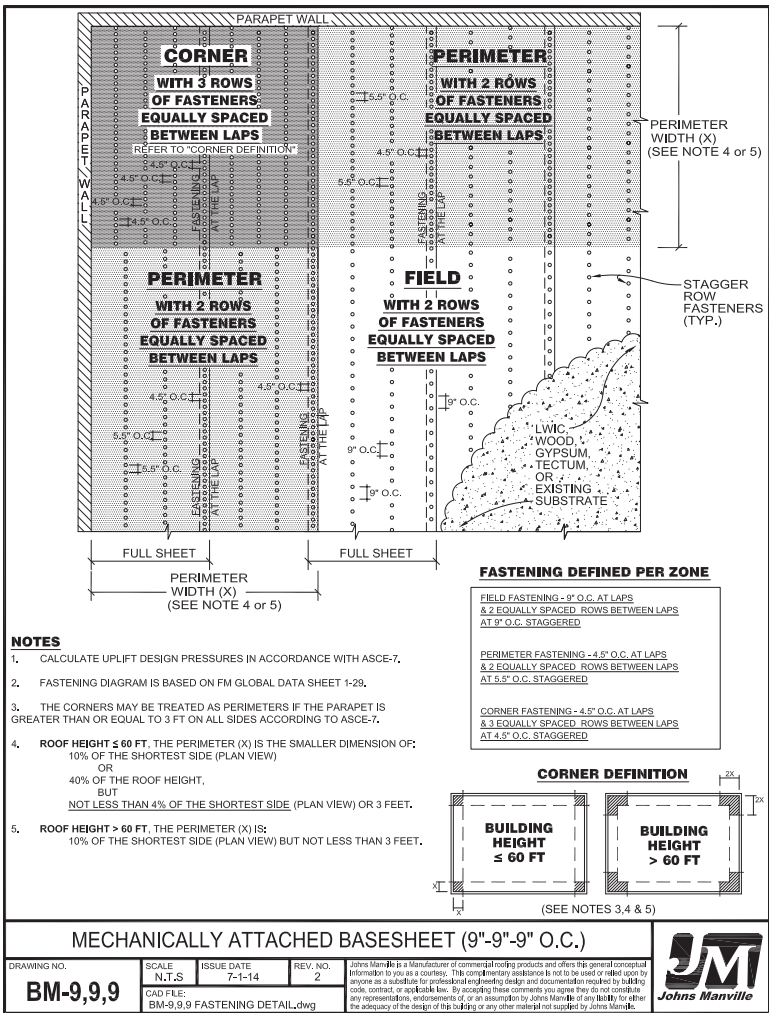

NOTES

- CALCULATE UPLIFT DESIGN PRESSURES IN ACCORDANCE WITH ASCE-7.
- FASTENING DIAGRAM IS BASED ON FM GLOBAL DATA SHEET 1-29.
- THE CORNERS MAY BE TREATED AS PERIMETERS IF THE PARAPET IS GREATER THAN OR EQUAL TO 3 FT ON ALL SIDES ACCORDING TO ASCE-7.
- ROOF HEIGHT ≤ 60 FT, THE PERIMETER (X) IS THE SMALLER DIMENSION OF: 10% OF THE SHORTEST SIDE (PLAN VIEW) OR 40% OF THE ROOF HEIGHT, BUT NOT LESS THAN 4% OF THE SHORTEST SIDE (PLAN VIEW) OR 3 FEET.
- ROOF HEIGHT > 60 FT, THE PERIMETER (X) IS: 10% OF THE SHORTEST SIDE (PLAN VIEW) BUT NOT LESS THAN 3 FEET.

Mechanically Fastened Base Sheet Fastening Patterns

SECTION THREE

Note: For the most current information on general guidelines, please refer to the System Considerations tab under Commercial Roofing Products on the JM Roofing Web site. For specifications, flashing details and general installation information please refer to the Application Tools tab.

Refer to the Safe Use Instructions and product label prior to using this product.

Mechanically Fastened Base Sheet Fastening Pattern BM-9,12,12

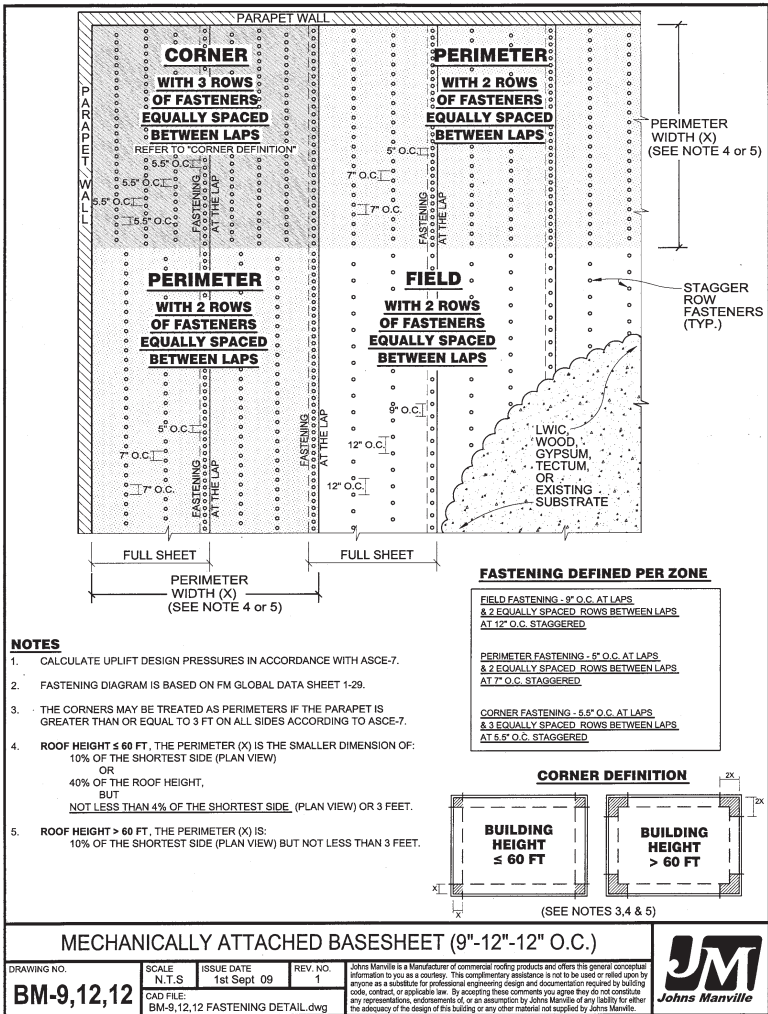

- NOTES**
- CALCULATE UPLIFT DESIGN PRESSURES IN ACCORDANCE WITH ASCE-7.
 - FASTENING DIAGRAM IS BASED ON FM GLOBAL DATA SHEET 1-29.
 - THE CORNERS MAY BE TREATED AS PERIMETERS IF THE PARAPET IS GREATER THAN OR EQUAL TO 3 FT ON ALL SIDES ACCORDING TO ASCE-7.
 - ROOF HEIGHT \leq 60 FT. THE PERIMETER (X) IS THE SMALLER DIMENSION OF:
 - 10% OF THE SHORTEST SIDE (PLAN VIEW) OR
 - 40% OF THE ROOF HEIGHT, BUT
 - NOT LESS THAN 4% OF THE SHORTEST SIDE, (PLAN VIEW) OR 3 FEET.
 - ROOF HEIGHT $>$ 60 FT. THE PERIMETER (X) IS:
 - 10% OF THE SHORTEST SIDE (PLAN VIEW) BUT NOT LESS THAN 3 FEET.

Mechanically Fastened Base Sheet Fastening Patterns

SECTION THREE

Note: For the most current information on general guidelines, please refer to the System Considerations tab under Commercial Roofing Products on the JM Roofing Web site. For specifications, flashing details and general installation information please refer to the Application Tools tab.

Refer to the Safe Use Instructions and product label prior to using this product.

Mechanically Fastened Base Sheet Fastening Pattern BM-9,18,18

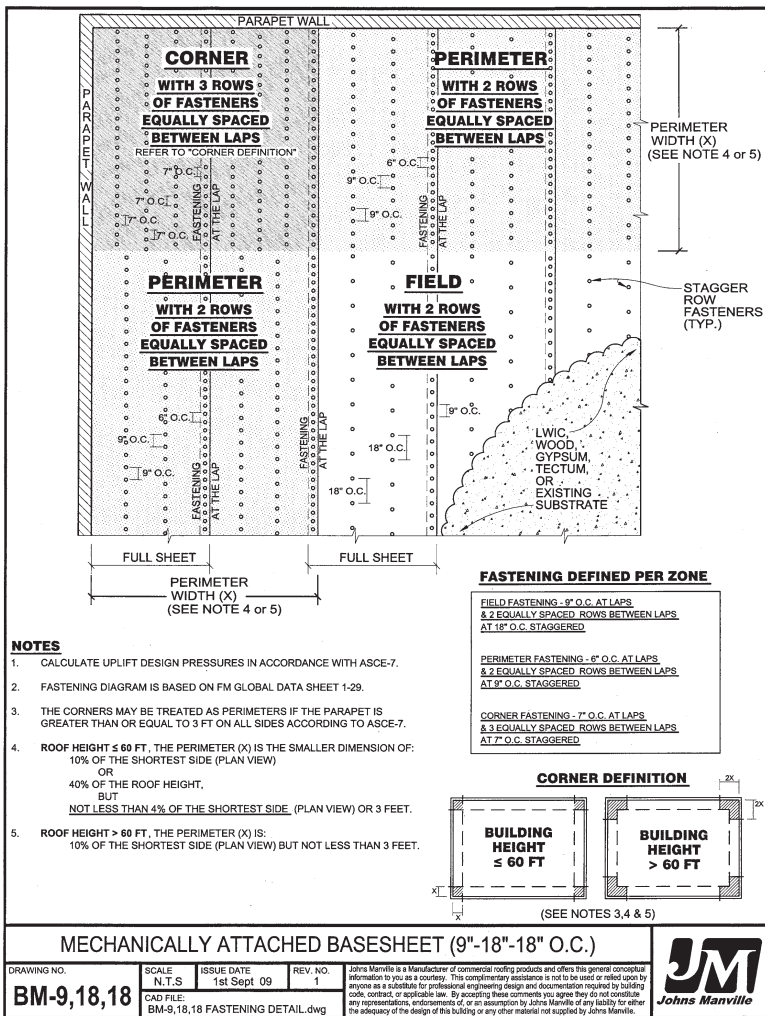

Mechanically Fastened Base Sheet Fastening Patterns

SECTION THREE

Note: For the most current information on general guidelines, please refer to the System Considerations tab under Commercial Roofing Products on the JM Roofing Web site. For specifications, flashing details and general installation information please refer to the Application Tools tab.

Refer to the Safe Use Instructions and product label prior to using this product.

Mechanically Fastened Base Sheet Fastening Pattern BM-12

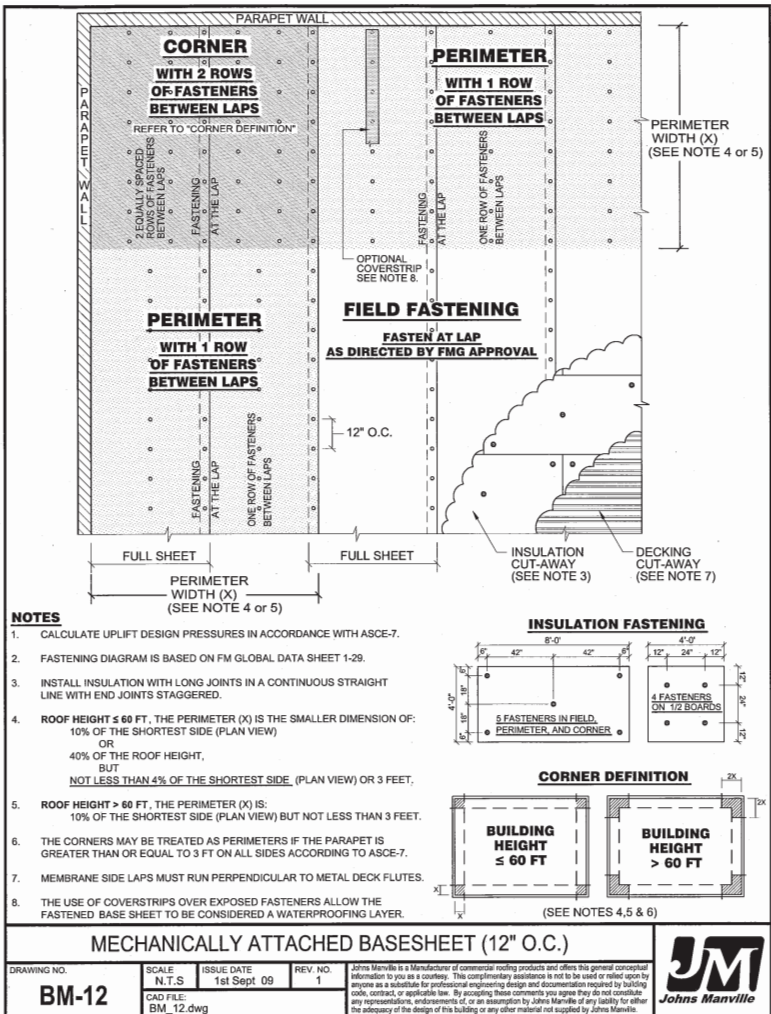

Mechanically Fastened Base Sheet Fastening Patterns

SECTION THREE

Note: For the most current information on general guidelines, please refer to the System Considerations tab under Commercial Roofing Products on the JM Roofing Web site. For specifications, flashing details and general installation information please refer to the Application Tools tab.

Refer to the Safe Use Instructions and product label prior to using this product.

Mechanically Fastened Base Sheet Fastening Pattern BM-12,12,12

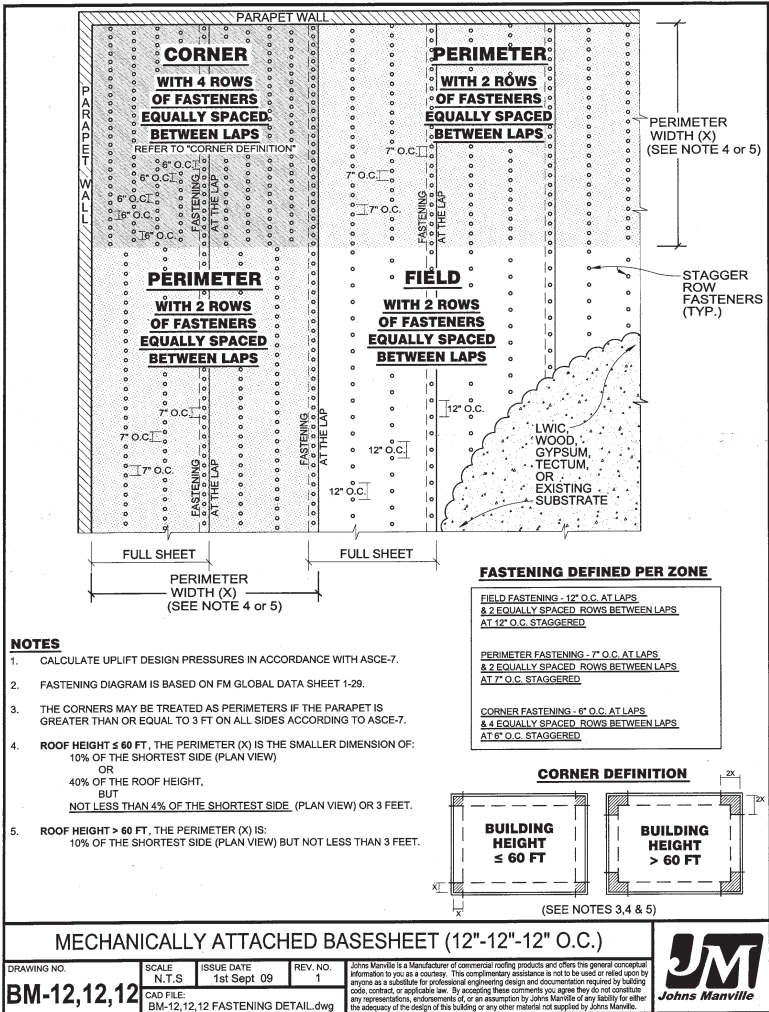

Mechanically Fastened Base Sheet Fastening Patterns

SECTION THREE

Note: For the most current information on general guidelines, please refer to the System Considerations tab under Commercial Roofing Products on the JM Roofing Web site. For specifications, flashing details and general installation information please refer to the Application Tools tab.

Refer to the Safe Use Instructions and product label prior to using this product.

Mechanically Fastened Base Sheet Fastening Pattern BM-18, 12, 6

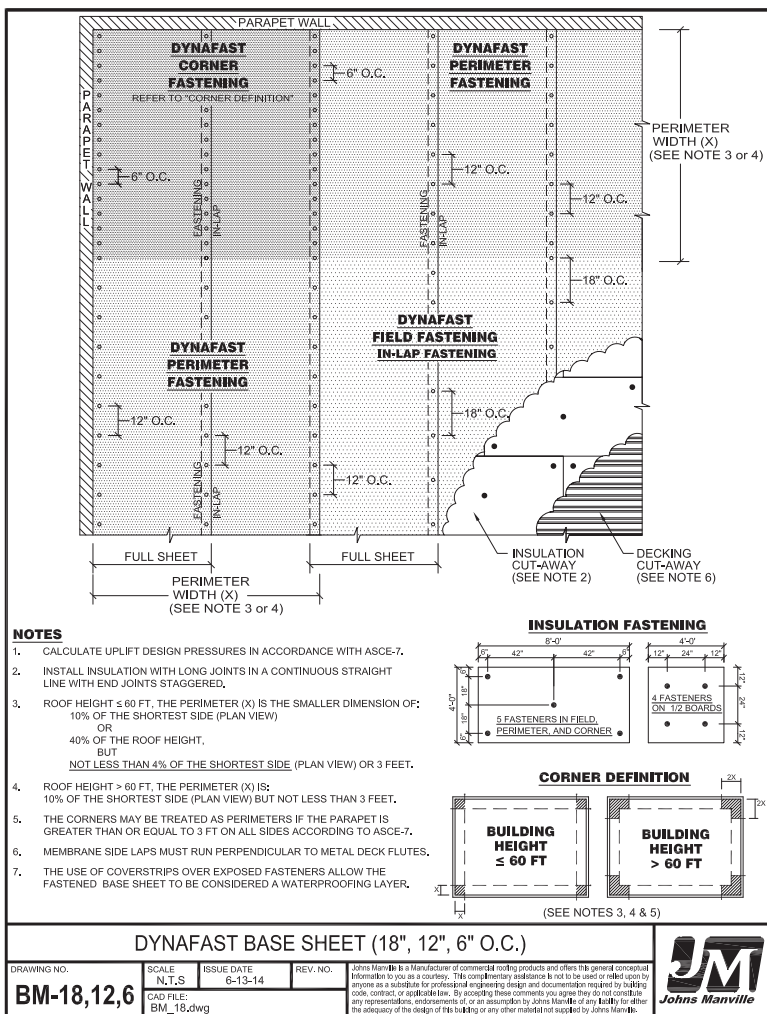

Mechanically Fastened Base Sheet Fastening Patterns

SECTION THREE

Note: For the most current information on general guidelines, please refer to the System Considerations tab under Commercial Roofing Products on the JM Roofing Web site. For specifications, flashing details and general installation information please refer to the Application Tools tab.

Refer to the Safe Use Instructions and product label prior to using this product.

4

APP Flashing Details

Section Four Contents

1.0	<i>General Information.....</i>	4-1
2.0	<i>Flashing Principles.....</i>	4-1
3.0	<i>Substrate/Flashing Preparation.....</i>	4-2
4.0	<i>Typical Flashing Conditions</i>	4-3
5.0	<i>Recommend JM SBS and JM APP.....</i>	4-5
	<i>Flashing Details Table of Contents</i>	4-6



Download a free QR Reader app on your smart phone. When you see a QR code, use your phone to scan the code. It will then redirect your phone to a specific video or detail. These codes will allow you to view step by step instructional videos and will allow you to zoom in on details for better readability. If you are viewing this booklet online you can click on these codes to direct you to the online videos and details as well.

1.0 General Information

1.1 Flashings are used to make watertight any roof area where the roof membrane terminates, is interrupted or intersects an area or projection having a marked change in slope or direction. This condition can occur at gravel stops, curbs, parapets, walls, built-in gutters, expansion joints, skylights, vents, drains, pipes and other penetrations.

1.2 Flashings are generally divided into several categories: bituminous flashing (base flashings and stripping), counterflashings/cap flashings, copings, perimeter edge metal and “flanged” metal flashings.

- A. Base flashings are, in a sense, a continuation of the membrane, turned up onto a surface that is in a different plane from the field of the roof, and installed as a separate operation. They are usually fabricated using a nonmetallic material, such as a bituminous-coated felt. Stripping is a bituminous flashing used to waterproof metal flanges.
- B. Perimeter edge metal (gravel stop, drip edge, gutter edge, fascia) is available in various configurations and is critical in sealing the roof membrane edges and roof system attachments.
- C. “Flanged” metal flashings are those metal flashings in which the horizontal deck flange is “sandwiched” between the primary roof membrane and bituminous stripping materials. Examples include vent stack leads, metal cone jacks, penetration pans, etc. JM recommends the use of better, more maintenance-free details for flashing roof projections. JM also recognizes that, at times, these types of flashings may be the best or only alternative.
- D. Counterflashings, or cap flashings, can be fabricated with metal, coated felt or other materials. They shield and seal the exposed edges of the base flashing.
- E. Copings also shield and seal the exposed edges of the base flashing. The vast majority of copings are fabricated from metal. Stone and tile are also common coping materials.

1.3 JM markets several different metal coping and perimeter edge metal systems. These systems are manufactured to meet stringent JM standards and, therefore, can be incorporated into the JM Peak Advantage Guarantee. It is permissible to incorporate “shop-fabricated” copings and perimeter edge metal into the roof system; however, these components are not generally covered under the JM guarantee. In some instances, JM will extend coverage on shop-fabricated metal if the request is made prior to job start. JM must review and approve all metal details. There may be additional fees for this service

1.4 All general instructions contained in the current JM Roofing Solutions Product Manual are to be considered part of this specification.

1.5 All health, safety and environmental procedures involving the storage, use and disposal of roofing materials should be followed. These precautions are outlined in the “Introduction” section of the current Johns Manville Roofing Systems Product Manual.

2.0 Flashing Principles

2.1 The performance of any flashing system is ultimately dependent on proper design, attachment and preparation.

2.2 Flashings must allow for differential movement in the flashing system, particularly when the deck and wall are not directly tied to each other (non-load-bearing construction). Differential movement between the roof deck and the wall is usually evidenced by diagonal wrinkles in the base flashing. Continued movement can cause tears in the flashing, particularly at the most restricted areas. Use roof-to-wall expansion joint details if the movement cannot be handled by standard base flashing systems. Expansion joints are typically installed at changes in the structural deck type,

changes in the direction of metal decking, at the base, transition of non-wall-supported decks and/or any area where significant differential movement is anticipated.

2.3 Avoid sharp bends in built-up and modified bitumen base flashings. Right-angle bends in bituminous flashings create high stress areas and can result in premature aging of the flashing material. To alleviate this condition and to provide solid backing, which protects the flashing from impact, the use of cant strips is necessary.

2.4 The combined use of nonmetallic materials for base flashings and metal for counterflashings brings out the best in each material. Bituminous base flashing materials have the same coefficient of expansion and contraction as the roof membrane, and they work together as a unit. They are the only type of material acceptable for use in constructing base flashings in bituminous systems.

2.5 Because of the rigidity of metal and its extreme movement with temperature changes, its use is not acceptable for base flashings. Cap flashings or counter flashings made of metal, removed from any area of possible standing water are acceptable, provided they are properly installed in accordance with industry-accepted sheet metal details.

3.0 Substrate/Flashing Preparation

3.1 All surfaces to be flashed/stripped should be inspected before any flashing work is started. Surfaces must be sound, dry and free of any loose materials or contaminants. Fins, sharp ridges, metal rods, etc., or any other circumstance that would puncture or cut the bituminous flashing/stripping or prevent proper adhesion of the same must be corrected.

3.2 Provide wood blocking (pressure treated with a salt preservative) to serve as a base for attaching the flanges of metal edging and “flanged” metal flashings. Treatment of the nailers with creosote or asphaltic preservatives is not acceptable. Extend the wood nailers horizontally beyond the flanges of the metal edgings and flashings. All new and existing wood nailers must be firmly attached to the structure with the appropriate fasteners at a rate sufficient for the project as required by the local building code. Information on nailer attachment can be found in FM Global Loss Prevention Data Sheet 1-49, entitled “Perimeter Flashing,” found on www.roofnav.com.

3.3 Any sheet metal flanges that are to be “sandwiched” between the primary roof membrane and bituminous flashing materials shall be properly cleaned and primed with JM Asphalt Primer on both top and bottom surfaces. Allow the primer to dry thoroughly prior to application.

3.4 Masonry Construction: Walls should be built with hard-burned brick, sound-reinforced concrete or waterproof concrete block construction. Common faults encountered are:

1. Soft or scaling brick or concrete.
2. Poor mortar or faulty pointing of joints.
3. Broken copings and inadequate pointing of joints between copings. Walls of ordinary hollow tile, or other materials that in themselves are not waterproof, are not suitable to receive flashings unless they are properly waterproofed. Prime all masonry surfaces that are to receive bituminous flashing with JM Asphalt Primer. Allow the primer to dry thoroughly prior to application of flashing.

3.5 Frame Construction: Frame walls are not acceptable to receive flashing unless suitable solid backing for the flashing is provided. A bituminous base sheet is typically mechanically attached over the surface prior to flashing installation. Gypsum wallboard is not acceptable as a substrate for bituminous flashings. Suitable stops and sheet metal flashing should be provided in EIFS and stucco construction to seal the top of the base flashing.

3.6 Any previously installed metal coping or counterflashing must be lifted or removed, to permit application of the base flashing.

4.0 Typical Flashing Conditions

4.1 Bituminous Base Flashing

- A. Install all layers comprising the primary roof membrane to the top of the cant before installing the base flashing. Do not carry the roofing membrane all the way up a wall, parapet or curb to act as a base flashing.
- B. The completed base flashing should extend between 8" (203 mm) and 24" (610mm) above the level of the roof and onto the roof membrane a minimum of 4" (102 mm). In multiple-layer flashings, all layers shall be offset a minimum of 6" (152 mm) from each other. All vertical joints are to be overlapped a minimum of 4" (102 mm) and well sealed.
- C. Good roofing practice dictates that the top edge of all base flashings must be carried a minimum of 8" (203 mm) above the roof. Certain project conditions may necessitate lower base flashing heights. The decision to incorporate base flashing heights less than 8" (203 mm) into a roof system rests solely with the building owner and the design professional. Typically, this decision is made as an initial cost-saving initiative on behalf of the owner. The building owner and design professional take full responsibility for this decision and acknowledge that the guarantee effectively stops at the top of the membrane base flashing.
- D. Secure all base flashings at the top edge with appropriate mechanical fasteners, spaced 6" (152 mm) o.c. maximum. The fasteners shall have a minimum 1" (25 mm) diameter head or plate. Fasteners shall be placed 1.5" (38 mm) from the top edge of the base flashing.
- E. Never install new base flashing above or over the top of existing thru-wall flashing. If the existing thru-wall flashing prohibits proper flashing height, the building owner and the design professional must be notified promptly. The decision to incorporate base flashing heights less than 8" (203 mm) into a roof system rests solely with the building owner and the design professional. Both the building owner and design professional take full responsibility for this decision and acknowledge that the guarantee effectively stops at the top of the membrane base flashing.

4.2 Perimeter Edge Metal (drip edge, gravel stop, etc.)

- A. Install all layers of the primary roof membrane so that it fully covers the perimeter wood blocking.
- B. All perimeter edge metal must be securely anchored over the top of the primary roof membrane. The solid attachment of all edge-metal-to-wood nailers is critical. The wood nailers must extend horizontally beyond the metal flange. Perimeter edge metal shall be attached at a rate sufficient for the project as required by the local building code. Information on perimeter edge metal attachment can be found in FM Global Loss Prevention Data Sheet 1-49, entitled "Perimeter Flashing," found on www.roofnav.com. Movement due to poor securement will result in abnormal stress on the membrane and flashing, which can cause leaks.
- C. Locate metal flanges (drip edge, gravel stop, etc.) that will be flashed or "stripped in" above the highest water level on the roof. Good roofing practice dictates that roof edges should be raised above the plane of the roof, whenever possible.
- D. All edge metal flanges (drip edge, gravel stop, etc.) that will be flashed or "stripped in" should be thoroughly cleaned to remove oil, oxidation or other contaminants, and then primed on both sides with JM Asphalt Primer. Set the metal sections on top of the primary roof membrane and into a 1/8" (3 mm) thick bed of MBR Flashing Cement or MBR Utility Cement, and fasten 3" (76 mm) o.c. on the horizontal flange, staggering the fasteners. Strip in the horizontal flange with the appropriate flashing material.

4.3 “Flanged” Metal Flashings (pipe jacks, cone jacks, penetration pans, etc.)

- A. Install all layers of the primary roof membrane so that it fully covers the wood blocking around the penetration.
- B. All “flanged” metal flashings must be securely anchored over the top of the primary roof membrane. The solid attachment of all metal flanges to wood nailers is critical. The wood nailers must extend horizontally beyond the metal flanges. Movement due to poor securement will result in abnormal stress on the membrane and flashing, which can cause leaks.
- C. Locate metal flanges that will be flashed or “stripped in” above the highest water level on the roof. Good roofing practice dictates that “sandwiched” metal flanges should be raised above the plane of the roof whenever possible.
- D. All metal flashing flanges that will be flashed or “stripped in” should be thoroughly cleaned to remove oil, oxidation or other contaminants and then primed on both sides with JM Asphalt Primer. Set the metal sections on top of the primary roof membrane and into a $\frac{1}{8}$ " (3 mm) thick bed of MBR Flashing Cement or MBR Utility Cement, and fasten 3" (76 mm) o.c. on the horizontal flange, staggering the fasteners. Flash the horizontal flange with the appropriate flashing material.
- E. JM does not recommend the use of penetration pan details, as by definition they require regular maintenance on the part of the owner.

4.4 High Wall Flashings

- A. High wall flashings or wall coverings are defined as membrane flashings on a vertical element in excess of 24" (610 mm) above the roof level. Bituminous flashings are very durable, but are also comparatively heavy. Two different flashing approaches are provided below.
- B. EPDM membrane: Apply base flashing, as outlined above. The completed base flashing should extend between 8" (203 mm) and 24" (610 mm) above the level of the roof membrane. Terminate the base flashing with an approved surface-mounted metal counterflashing, fastened 6" (152 mm) o.c. maximum with the appropriate fasteners. Apply JM EPDM membrane over the top of the wall and extending down over the metal counterflashing, using JM EPDM Bonding Cement. The EPDM wall cover should cover the metal counterflashing to the top of its drip edge, and must cover the fasteners in the metal counterflashing by a minimum of 2" (51 mm). The JM EPDM membrane shall be bonded to the properly primed sheet metal counter flashing with JM EPDM Seam Tape. Terminate the top of the EPDM membrane wall cover as required.
- C. Self-adhering flashings are not acceptable for this application.

4.5 Sheet Metal: All sheet metal (counterflashing, cap flashing, coping, edge metal, etc.) shall be installed in accordance with and conform to SMACNA guidelines and the manufacturer’s requirements. All counterflashing and coping should overlap the base flashing by a minimum of 4" (102 mm).

4.6 Coping: All copings, regardless of their makeup, should be set/installed on top of a waterproofing membrane, metal flashing, or both, so as to prevent any moisture originating from the coping entering the roof system.

4.7 Surfacing of Bituminous Flashing: Granule, “CR” and foil-surfaced flashings do not require additional surfacing. Unsurfaced flashing materials may be surfaced with any one of the appropriate coating materials provided by JM.

5.0 Recommend JM SBS and JM APP

5.1 Products for use in heat-weld installations:

SBS – Cap Sheets	SBS – Base Sheets
DynaWeld Cap FR DynaWeld Cap FR CR DynaWeld Cap 180 FR Dynaweld Cap 180 FR CR DynaWeld Cap 250 FR DynaWeld Cap 250 FR CR DynaWeld Cap DynaKap FR HW	DynaWeld Base DynaBase HW DynaWeld 180S DynaWeld 250S DynaPly HW
APP – Cap Sheets	APP – Base Sheets
APPeX 4.5M APPeX 4.5M FR Tricor M FR Bicolor M FR	APPeX 4S Tricor 2 Bicolor S

JM PermaFlash® Flashing Details

Roof Area Base Tie In Attachment

Corner

PMF-3	PermaFlash® Inside Corner Detail	4-12
PMF-3S	PermaFlash® Inside Corner Scrim Detail	4-13

Lap Angle Change

PMF-10	PermaFlash® Standard Base Flashing Detail	4-14
PMF-9	PermaFlash® Standard Canted Base Flashing Detail	4-15

Penetration, Equipment Support and Protection

Curb

PMF-4	PermaFlash® Curb Corner Detail	4-16
PMF-4Sa	PermaFlash® OS Corner Scrim Layout (Top)	4-17
PMF-4Sb	PermaFlash® OS Corner Scrim Layout (Bottom)	4-18

Drain

PMF-5	PermaFlash®-To-Drain-Detail	4-19
PMF-5S	PermaFlash® Drain Scrim Detail	4-20
PMF-7	PermaFlash® Through-Wall Scupper Detail	4-21
PMF-7S	PermaFlash® Through-Wall Scupper Scrim Detail	4-22
PMF-8	PermaFlash® Overflow Scupper Detail	4-23
PMF-8S	PermaFlash® Overflow Scupper Scrim Detail	4-24

Equipment Support

PMF-1	PermaFlash® I-Beam Detail	4-25
PMF-11	PermaFlash® Square Metal Tube Detail	4-26
PMF-11S	PermaFlash® Square Metal Tube Scrim Detail	4-27
PMF-1S	PermaFlash® I-Beam Scrim Detail	4-28
PMF-2	PermaFlash® Angle Iron Detail	4-29
PMF-2S	PermaFlash® Angle Iron Scrim Detail	4-30

Pipe & Vent

PMF-6	PermaFlash® Pipe Penetration Detail	4-31
PMF-6S	PermaFlash® Pipe Penetration Scrim Detail	4-32

JM APP Heat Weldable Flashing Details

Roof Area

Edge

HW-4 (GS)	Gravel Stop	4-33
HW-4 (GS-ALT)	Gravel Stop Alternate	4-34
HW-4 (GTR)	Gutter	4-35
HW-4 (PRESTO LOCK)	Presto Lock Fascia System	4-36
HW-4 (PRESTO-TITE)	Presto-Tite Edge Metal System	4-37
HW-4 (RMCF)	Raised Metal Cant Fascia	4-38

Expansion, Tie-In and Transition

HW-7	Curb Mounted Roof-to-Roof Expansion Joint Cover	4-39
HW-1 (NLB)	Curb to Wall E.J.	4-40

Penetration, Equipment Support and Protection

Curb

HW-26	Base Flashing at Outside Corner	4-41
HW-8	Prefabricated Curb	4-42

Drain

HW-12	JM Flex-I-Drain	4-43
HW-11	Metal Drain	4-44
HW-22	Overflow Metal Scupper	4-45
HW-21	Primary Metal Scupper in Sump	4-46

Equipment Support

HW-17	Lightning Rod on Roof Surface	4-47
HW-16	Penetration Pocket	4-48

Pipe & Vent

HW-10	FP-10 One Way® Roof Vent	4-49
HW-9	Plumbing Vent	4-50
HW-23	Vent Stack (Warm)	4-51

Wall Flashing

HW-27	Base Flashing at Inside Corner	4-52
HW-15 (E)	EPDM Wall Covering with Bituminous Base Flashing	4-53
HW-20 (WH)	Gypsum Wall on Metal Studs >24" w/ Coping	4-54
HW-20 (WL)	Gypsum Wall on Metal Studs <24" w/ Coping	4-55
HW-6 (TH)	Masonry Wall >24" with Coping	4-56
HW-6 (TL)	Masonry Wall <24" with Coping	4-57
HW-1 (LB)	Masonry Wall w/ Counterflashing	4-58
HW-25 (LB)	Optional Two-Ply Base Flashing for Load-Bearing Masonry Wall w/Counterflashing	4-59
HW-15 (T)	TPO Wall Covering with Bituminous Base Flashing	4-60
HW-15 (T-ALT)	TPO Wall Covering with Bituminous Base Flashing	4-61
HW-24	Venting Lightweight Concrete	4-62
HW-3 (WH)	Wood Wall >24" with Coping	4-63
HW-3 (WL)	Wood Wall <24" with Coping	4-64

Non Load Bearing

HW-1 (NLB)	Curb to Wall E.J.	4-65
HW-5 (NLB-ALT)	Metal E.J. Alternate	4-66

Vapor Barriers

VB-1	JM Vapor Barrier SA - Wall Base Detail	4-68
VB-1 (ALT)	JM Vapor Barrier SA - Wall Base Detail (Alt)	4-69
VB-2	JM Vapor Barrier SA - Pipe Penetration Detail	4-70
VB-3	JM Vapor Barrier SA - Drain Detail	4-71
VB-4	JM Vapor Barrier SA - Detail at Field Laps	4-72
VB-5	JM Vapor Barrier SA - Outside Curb Detail	4-73
VB-6	JM Vapor Barrier SA - Inside Curb Detail	4-74

Ensure all surfaces are clean, dry and free of any loose debris, dust, dirt and rust before coating.



1. Items you will need:

- MBR® Flashing Cement Cartridges
- Applicator (Gun), Nozzle and Restrictor
- PermaFlash Primer
- PermaFlash Scrim
- Scissors
- Masking Tape
- Brush or Roller
- Tape Measure or Ruler
- Clean Rag or Spray Bottle for Applying Primer
- Xylene* or other Cleaner
- Rubber Gloves

* Caution: Xylene may cause skin, eye and respiratory irritation. Review the manufacturer's Safety Data Sheet for safety and personal protective equipment information for the cleaning product used.



- ## 2. Where necessary, prepare surfaces using a grinder or other suitable means.



- ## 3. Prime the penetration with a light coating of PermaFlash Primer. A rag or spray bottle works best; a brush may apply too liberally.



Note: For the most current information on general guidelines, please refer to the System Considerations tab under Commercial Roofing Products on the JM Roofing Web site. For specifications, flashing details and general installation information please refer to the Application Tools tab.

Refer to the Safe Use Instructions and product label prior to using this product.



4. Use tape to mask off the top of the detail 8" (203 mm) above the roof and an 8" (203 mm) perimeter surrounding the detail.



5. Precut the first piece of PermaFlash Scream. Start 6" (152 mm) above the roof surface and extend fingers 6" (152 mm) onto the roof surface. PermaFlash Scream is 12" (305 mm) wide for ease of application.



6. Precut the second piece of PermaFlash Scream to serve as a target piece laying flat on the roof surrounding the penetration. Extend a minimum of 6" (152 mm) on the roof surface in all directions. (This will be 2" (51 mm) inside the masked off perimeter.)

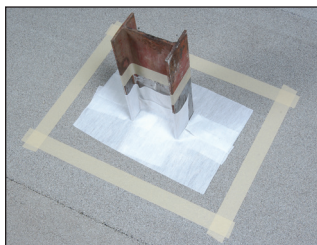

Note: For the most current information on general guidelines, please refer to the System Considerations tab under Commercial Roofing Products on the JM Roofing Web site. For specifications, flashing details and general installation information please refer to the Application Tools tab.

Refer to the Safe Use Instructions and product label prior to using this product.



7. Coat the masked off area with a very thin coating [30 mil (0.76 mm)] of MBR Flashing Cement. A brush works best.



8. Embed the first piece of PermaFlash Scrim.



9. Apply a light coating of MBR Flashing Cement.



10. Embed the second piece of PermaFlash Scrim.

Note: For the most current information on general guidelines, please refer to the System Considerations tab under Commercial Roofing Products on the JM Roofing Web site. For specifications, flashing details and general installation information please refer to the Application Tools tab.

Refer to the Safe Use Instructions and product label prior to using this product.



- 11.** Re-coat the entire masked off area with a thicker [60 mil (1.52 mm)] coating of MBR Flashing Cement.



- 12.** After drying, remove masking tape.

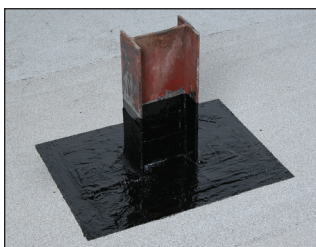

Completed Detail. ½ cartridge of MBR Flashing Cement used to complete detail.

Note: For the most current information on general guidelines, please refer to the System Considerations tab under Commercial Roofing Products on the JM Roofing Web site. For specifications, flashing details and general installation information please refer to the Application Tools tab.

Refer to the Safe Use Instructions and product label prior to using this product.



PermaFlash® Inside Corner Detail

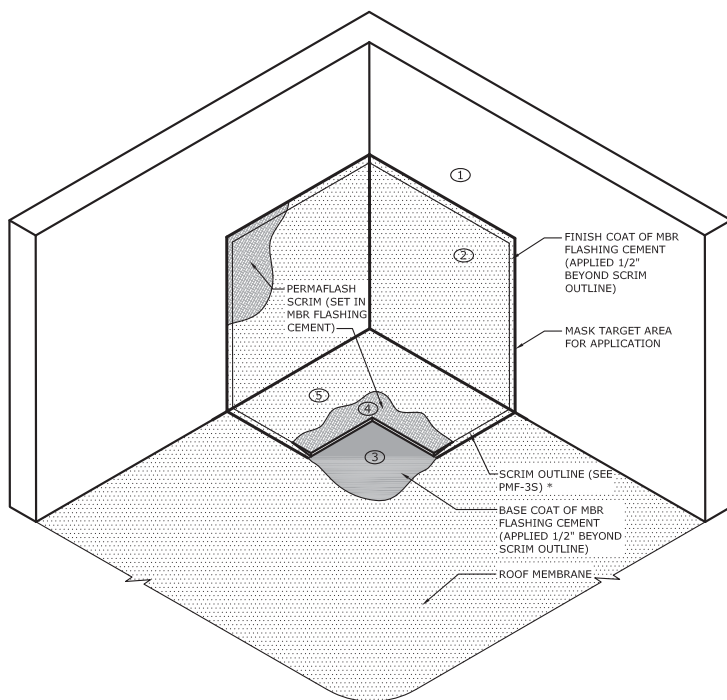

NOTES:

- A. USE THIS DETAIL IN CONJUNCTION WITH THE PERMAFLASH INSIDE CORNER SCRIM LAYOUT, DRAWING PMF-3S.
- B. ENSURE TOTAL TARGET AREA OF FLASHING IS NO LESS THAN 16" x 16".
- C. AN EXTRA COAT OF MBR FLASHING CEMENT MUST BE PLACED BETWEEN SCRIM LAYERS WHERE THEY OVERLAP TO ENSURE A PROPER BOND.
- D. REFER TO PERMAFLASH APPLICATION INSTRUCTIONS FOR GENERAL GUIDELINES REGARDING THE PERMAFLASH SYSTEM.
- E. JM RECOMMENDS DIMENSION "x" TO BE AT LEAST 8", BUT VARIATION IS ALLOWED FOR LOWER THRESHOLDS.
* SEE PMF-3S IF DETAIL UTILIZES CANT STRIP

ASSEMBLY

- ① MASK TARGET AREA ON ROOF MEMBRANE AND PENETRATION.
- ② CLEAN & PRIME ALL NON-POROUS AREAS (METAL, ETC...) REQUIRING LIQUID MEMBRANE WITH PERMAFLASH PRIMER.
- ③ APPLY 30 MIL. BASE COAT OF MBR FLASHING CEMENT WITHIN TARGET AREA. (A BRUSH WORKS BEST).
- ④ EMBED SCRIM(S) INTO WET BASE COAT OF MBR FLASHING CEMENT, 1/2" SHORT OF TARGET AREA.
- ⑤ IMMEDIATELY AFTER EMBEDDING THE SCRIM, APPLY 60 MIL. FINISH COAT OF MBR FLASHING CEMENT OVER SCRIM AND 1/2" BEYOND, ENSURING SCRIM IS COMPLETELY EMBEDDED.
- ⑥ REMOVE MASKING TAPE IMMEDIATELY AFTER APPLICATION OF FINISH COAT.

Johns Manville is a manufacturer of commercial roofing products and offers this general conceptual information to you as a courtesy. This complimentary assistance is not to be used or relied upon by anyone as a substitute for professional engineering design and documentation required by building code, contract, or applicable law. By accepting these comments you agree they do not constitute any representations, endorsements of, or an assumption by Johns Manville of any liability for either the adequacy of design of this building or any other material not supplied by Johns Manville.

Note: For the most current information on general guidelines, please refer to the System Considerations tab under Commercial Roofing Products on the JM Roofing Web site. For specifications, flashing details and general installation information please refer to the Application Tools tab.

Refer to the Safe Use Instructions and product label prior to using this product.



PermaFlash® Inside Corner Scrim Detail

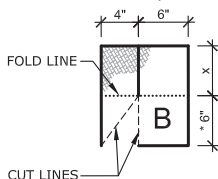
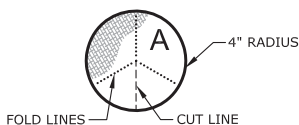
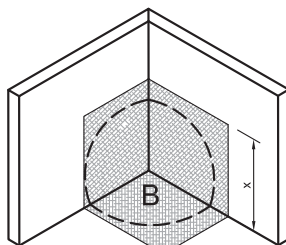
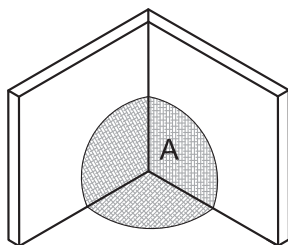

A CORNER REINFORCEMENT STEP A

B WALL TRANSITION STEP B

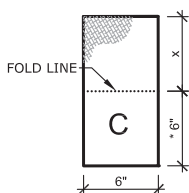
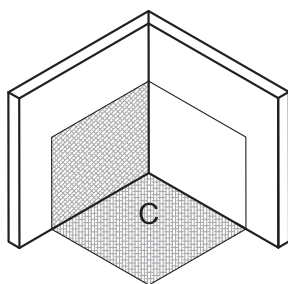

C WALL REINFORCEMENT STEP C

NOTES:

- A. USE SCRIM LAYOUT IN CONJUNCTION WITH THE PERMAFLASH INSIDE CORNER DETAIL DRAWING, PMF-3.
 - B. ALL FOLD LINES REPRESENTED AS ALL CUT LINES REPRESENTED AS - - - - -
 - C. AN EXTRA COAT OF MBR FLASHING CEMENT MUST BE PLACED BETWEEN SCRIM LAYERS WHERE THEY OVERLAP TO ENSURE A PROPER BOND.
 - D. JM RECOMMENDS DIMENSION "x" TO BE AT LEAST 6", BUT VARIATION IS ALLOWED FOR LOWER THRESHOLDS.
- * ADD 3 1/2" IF DETAIL UTILIZES CANT STRIP

Johns Manville is a manufacturer of commercial roofing products and offers this general conceptual information to you as a courtesy. This complimentary assistance is not to be used or relied upon by anyone as a substitute for professional engineering design and documentation required by building code, contract, or applicable law. By accepting these comments you agree they do not constitute any representations, endorsements of, or an assumption by Johns Manville of any liability for either the adequacy of design of this building or any other material not supplied by Johns Manville.

Note: For the most current information on general guidelines, please refer to the System Considerations tab under Commercial Roofing Products on the JM Roofing Web site. For specifications, flashing details and general installation information please refer to the Application Tools tab.

Refer to the Safe Use Instructions and product label prior to using this product.



PermaFlash® Standard Base Flashing Detail

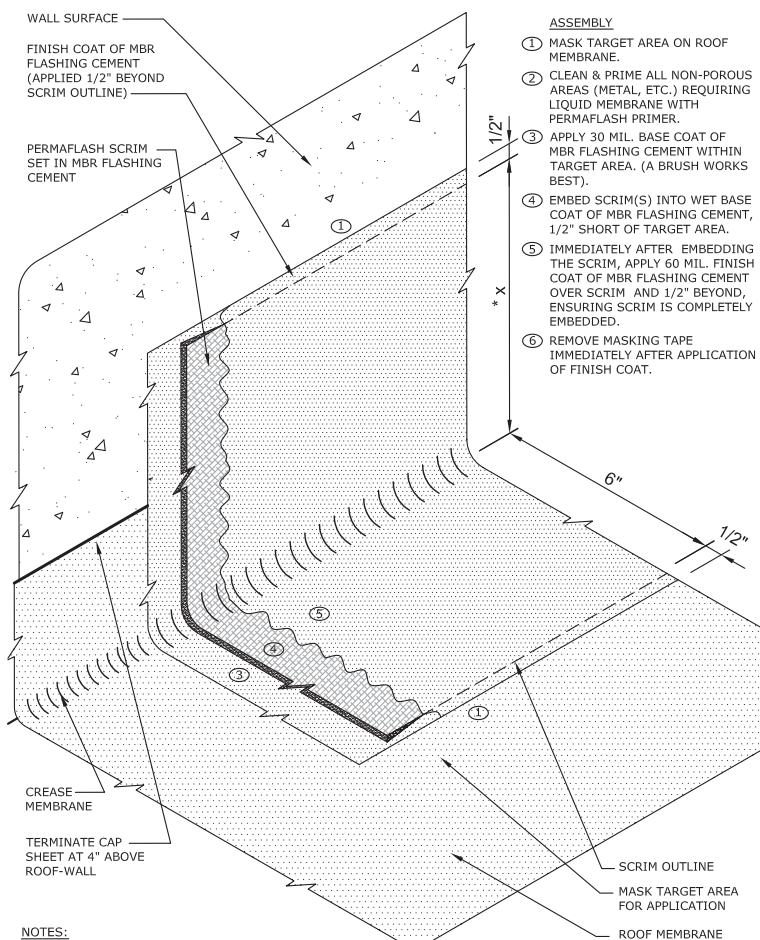

NOTES:

1. AN EXTRA COAT OF MBR FLASHING CEMENT MUST BE PLACED BETWEEN SCRIM LAYERS WHERE THEY OVERLAP TO ENSURE A PROPER BOND.
2. REFER TO PERMAFLASH APPLICATION INSTRUCTIONS FOR GENERAL GUIDELINES REGARDING THE PERMAFLASH SYSTEM.
3. * "X" DIMENSION DEPENDANT UPON APPLICATION.

ASSEMBLY

- 1 MASK TARGET AREA ON ROOF MEMBRANE.
- 2 CLEAN & PRIME ALL NON-POROUS AREAS (METAL, ETC.) REQUIRING LIQUID MEMBRANE WITH PERMAFLASH PRIMER.
- 3 APPLY 30 MIL. BASE COAT OF MBR FLASHING CEMENT WITHIN TARGET AREA. (A BRUSH WORKS BEST).
- 4 EMBED SCRIM(S) INTO WET BASE COAT OF MBR FLASHING CEMENT, 1/2" SHORT OF TARGET AREA.
- 5 IMMEDIATELY AFTER EMBEDDING THE SCRIM, APPLY 60 MIL. FINISH COAT OF MBR FLASHING CEMENT OVER SCRIM AND 1/2" BEYOND, ENSURING SCRIM IS COMPLETELY EMBEDDED.
- 6 REMOVE MASKING TAPE IMMEDIATELY AFTER APPLICATION OF FINISH COAT.

Johns Manville is a manufacturer of commercial roofing products and offers this general conceptual information to you as a courtesy. This complimentary assistance is not to be used or relied upon by anyone as a substitute for professional engineering design and documentation required by building code, contract, or applicable law. By accepting these comments you agree they do not constitute any representations, endorsements of, or an assumption by Johns Manville of any liability for either the adequacy of design of this building or any other material not supplied by Johns Manville.

Note: For the most current information on general guidelines, please refer to the System Considerations tab under Commercial Roofing Products on the JM Roofing Web site. For specifications, flashing details and general installation information please refer to the Application Tools tab.

Refer to the Safe Use Instructions and product label prior to using this product.



PermaFlash® Standard Canted Base Flashing Detail

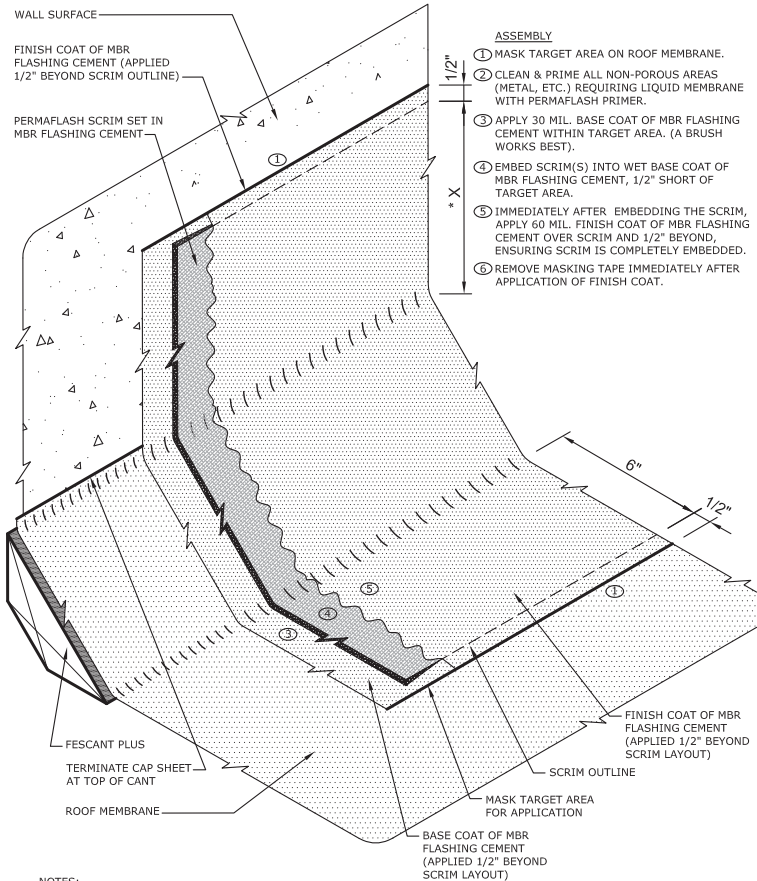

NOTES:

- A. AN EXTRA COAT OF MBR FLASHING CEMENT MUST BE PLACED BETWEEN SCRIM LAYERS WHERE THEY OVERLAP TO ENSURE A PROPER BOND.
- B. REFER TO PERMAFLASH APPLICATION INSTRUCTIONS FOR GENERAL GUIDELINES REGARDING THE PERMAFLASH SYSTEM.

* "x" DIMENSION DEPENDANT UPON APPLICATION.

Johns Manville is a manufacturer of commercial roofing products and offers this general conceptual information to you as a courtesy. This complimentary assistance is not to be used or relied upon by anyone as a substitute for professional engineering design and documentation required by building code, contract, or applicable law. By accepting these comments you agree they do not constitute any representations, endorsements of, or an assumption by Johns Manville of any liability for either the adequacy of design of this building or any other material not supplied by Johns Manville.

Note: For the most current information on general guidelines, please refer to the System Considerations tab under Commercial Roofing Products on the JM Roofing Web site. For specifications, flashing details and general installation information please refer to the Application Tools tab.

Refer to the Safe Use Instructions and product label prior to using this product.



PermaFlash® Curb Corner Detail

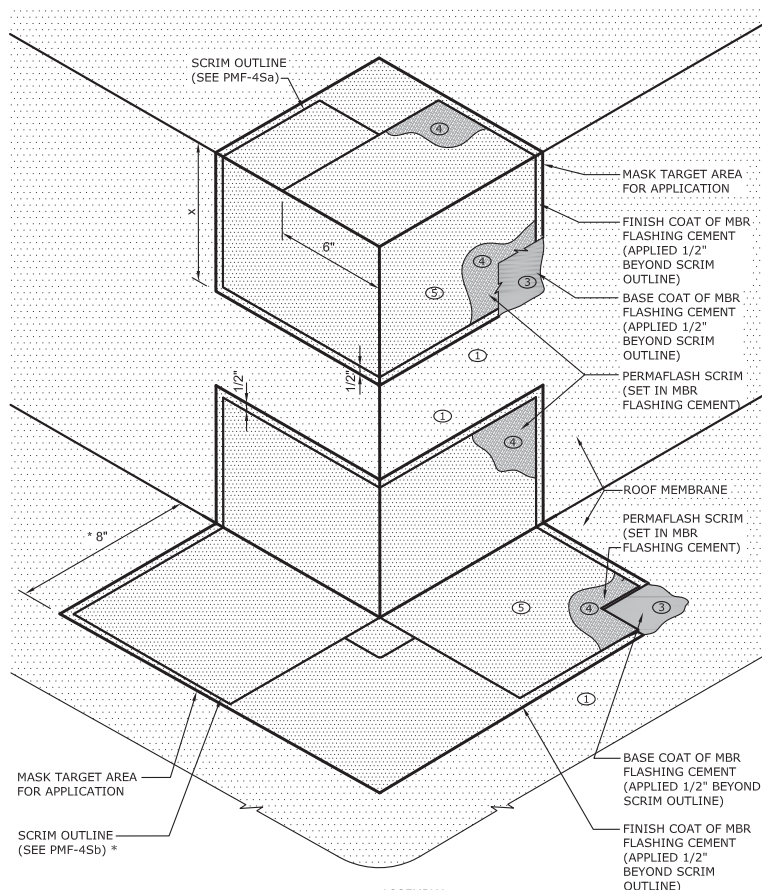

NOTES:

- A. USE THIS DETAIL IN CONJUNCTION WITH THE PERMAFLASH OUTSIDE CORNER SCRIM DETAILS PMF-4Sa & PMF-4Sb.
- B. ENSURE TOTAL TARGET AREA OF FLASHING IS NO LESS THAN 16" x 16".
- C. AN EXTRA COAT OF MBR FLASHING CEMENT MUST BE PLACED BETWEEN SCRIM LAYERS WHERE THEY OVERLAP TO ENSURE A PROPER BOND.
- D. REFER TO PERMAFLASH APPLICATION INSTRUCTIONS FOR GENERAL GUIDELINES REGARDING THE PERMAFLASH SYSTEM.
- E. JM RECOMMENDS DIMENSION "x" TO BE AT LEAST 8", BUT VARIATION IS ALLOWED FOR LOWER THRESHOLDS.

* SEE PMF-4Sb IF DETAIL UTILIZES CANT STRIP

ASSEMBLY

- ① MASK TARGET AREA ON ROOF MEMBRANE AND PENETRATION.
- ② CLEAN & PRIME ALL NON-POROUS AREAS (METAL, ETC...) REQUIRING LIQUID MEMBRANE WITH PERMAFLASH PRIMER.
- ③ APPLY 30 MIL. BASE COAT OF MBR FLASHING CEMENT WITHIN TARGET AREA. (A BRUSH WORKS BEST).
- ④ EMBED SCRIM(S) INTO WET BASE COAT OF MBR FLASHING CEMENT, 1/2" SHORT OF TARGET AREA.
- ⑤ IMMEDIATELY AFTER EMBEDDING THE SCRIM, APPLY 60 MIL. FINISH COAT OF MBR FLASHING CEMENT OVER SCRIM AND 1/2" BEYOND, ENSURING SCRIM IS COMPLETELY EMBEDDED.
- ⑥ REMOVE MASKING TAPE IMMEDIATELY AFTER APPLICATION OF FINISH COAT.

Johns Manville is a manufacturer of commercial roofing products and offers this general conceptual information to you as a courtesy. This complimentary assistance is not to be used or relied upon by anyone as a substitute for professional engineering design and documentation required by building code, contract, or applicable law. By accepting these comments you agree they do not constitute any representations, endorsements of, or an assumption by Johns Manville of any liability for either the adequacy of design of this building or any other material not supplied by Johns Manville.

Note: For the most current information on general guidelines, please refer to the System Considerations tab under Commercial Roofing Products on the JM Roofing Web site. For specifications, flashing details and general installation information please refer to the Application Tools tab.

Refer to the Safe Use Instructions and product label prior to using this product.



PermaFlash® OS Corner Scrim Layout (Top)

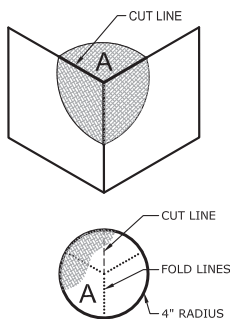

A CORNER REINFORCEMENT
STEP A

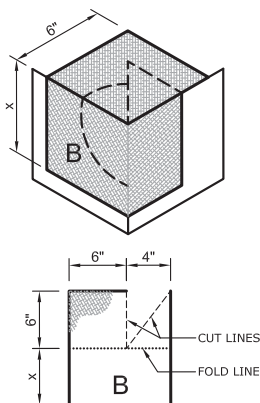

B WALL TRANSITION
STEP B

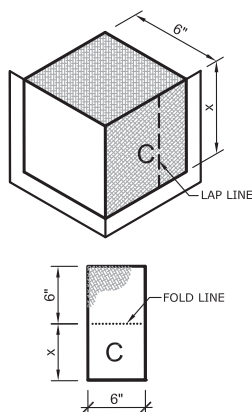

C WALL REINFORCEMENT
STEP C

NOTES:

- A. USE SCRIM LAYOUT IN CONJUNCTION WITH THE PERMAFLASH CURB CORNER DETAIL DRAWING, PMF-4.
- B. ALL FOLD LINES REPRESENTED AS ALL CUT LINES REPRESENTED AS - - - - -
- C. AN EXTRA COAT OF MBR FLASHING CEMENT MUST BE PLACED BETWEEN SCRIM LAYERS WHERE THEY OVERLAP TO ENSURE A PROPER BOND.
- D. JM RECOMMENDS DIMENSION "x" TO BE AT LEAST 6", BUT VARIATION IS ALLOWED FOR LOWER THRESHOLDS.

Johns Manville is a manufacturer of commercial roofing products and offers this general conceptual information to you as a courtesy. This complimentary assistance is not to be used or relied upon by anyone as a substitute for professional engineering design and documentation required by building code, contract, or applicable law. By accepting these comments you agree they do not constitute any representations, endorsements of, or an assumption by Johns Manville of any liability for either the adequacy of design of this building or any other material not supplied by Johns Manville.

Note: For the most current information on general guidelines, please refer to the System Considerations tab under Commercial Roofing Products on the JM Roofing Web site. For specifications, flashing details and general installation information please refer to the Application Tools tab.

Refer to the Safe Use Instructions and product label prior to using this product.



PermaFlash® OS Corner Scrim Layout (Bottom)

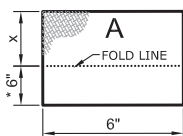
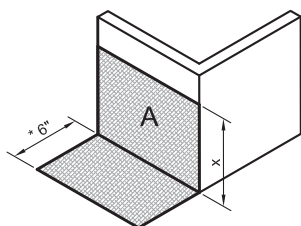

A WALL REINFORCEMENT STEP A

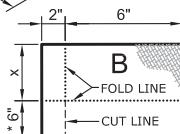
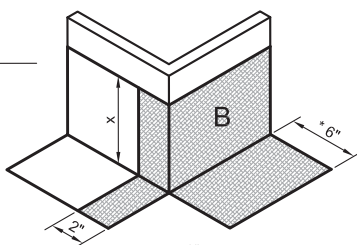

B WALL TRANSITION STEP B

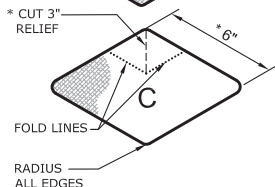
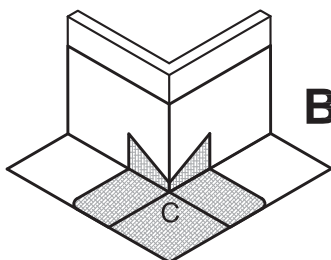

C CORNER REINFORCEMENT STEP C

NOTES:

- A. USE SCRIM LAYOUT IN CONJUNCTION WITH THE PERMAFLASH CURB CORNER DETAIL DRAWING, PMF-4.
- B. ALL FOLD LINES REPRESENTED AS ALL CUT LINES REPRESENTED AS -----
- C. AN EXTRA COAT OF MBR FLASHING CEMENT MUST BE PLACED BETWEEN SCRIM LAYERS WHERE THEY OVERLAP TO ENSURE A PROPER BOND.
- D. JM RECOMMENDS DIMENSION "x" TO BE AT LEAST 6", BUT VARIATION IS ALLOWED FOR LOWER THRESHOLDS.
- * ADD 3 1/2" IF DETAIL UTILIZES CANT STRIP

Johns Manville is a manufacturer of commercial roofing products and offers this general conceptual information to you as a courtesy. This complimentary assistance is not to be used or relied upon by anyone as a substitute for professional engineering design and documentation required by building code, contract, or applicable law. By accepting these comments you agree they do not constitute any representations, endorsements of, or an assumption by Johns Manville of any liability for either the adequacy of design of this building or any other material not supplied by Johns Manville.

Note: For the most current information on general guidelines, please refer to the System Considerations tab under Commercial Roofing Products on the JM Roofing Web site. For specifications, flashing details and general installation information please refer to the Application Tools tab.

Refer to the Safe Use Instructions and product label prior to using this product.



PermaFlash®-To-Drain-Detail

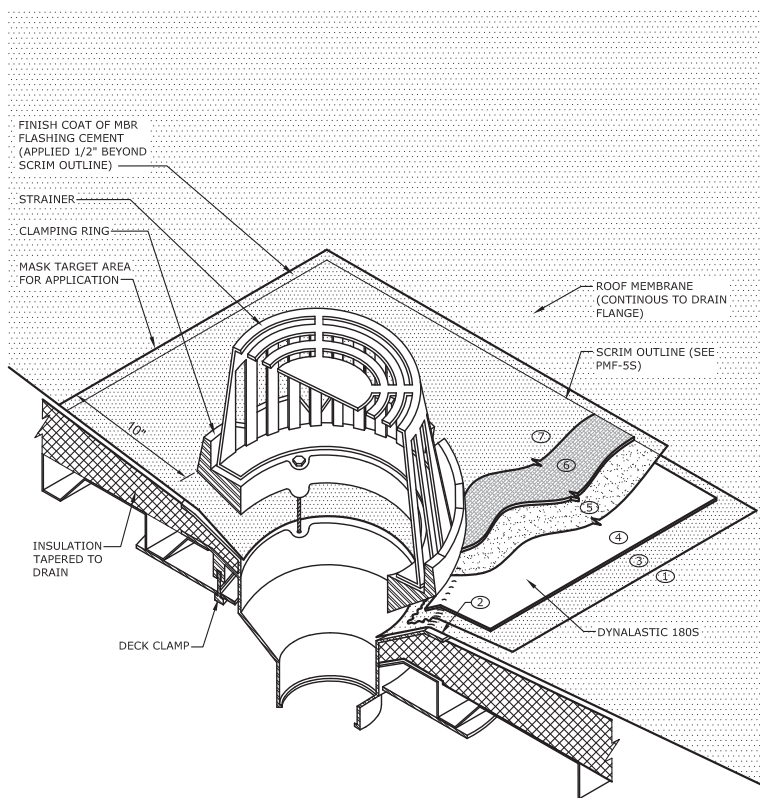

ASSEMBLY

- ① MASK TARGET AREA ON ROOF MEMBRANE.
- ② CLEAN & PRIME ALL NON-POROUS AREAS (METAL, ETC.) REQUIRING LIQUID MEMBRANE WITH PERMAFLASH PRIMER.
- ③ APPLY 30 MIL. COAT OF MBR FLASHING CEMENT WITHIN TARGET AREA AS SHOWN. (A BRUSH WORKS BEST).
- ④ EMBED DYNALASTIC 180S INTO WET COAT OF MBR FLASHING CEMENT, 1/2" SHORT OF TARGET AREA.
- ⑤ APPLY 30 MIL. BASE COAT OF PERMAFLASH OVER DYNALASTIC 180S AND 1/2" BEYOND, ENSURING IT IS COMPLETELY EMBEDDED.
- ⑥ EMBED SCRIM INTO WET BASE COAT OF MBR FLASHING CEMENT, 2" SHORT OF TARGET AREA.
- ⑦ IMMEDIATELY AFTER EMBEDDING THE SCRIM, APPLY 60 MIL. FINISH COAT OF MBR FLASHING CEMENT OVER SCRIM AND 1/2" BEYOND, ENSURING SCRIM IS COMPLETELY EMBEDDED.
- ⑧ REMOVE MASKING TAPE IMMEDIATELY AFTER APPLICATION OF FINISH COAT.

NOTES:

- A. USE THIS DETAIL IN CONJUNCTION WITH THE PERMAFLASH DRAIN SCRIM LAYOUT, DRAWING PMF-5S.
- B. ENSURE TOTAL TARGET AREA OF FLASHING IS NO LESS THAN 28"x28".
- C. AN EXTRA COAT OF MBR FLASHING CEMENT MUST BE PLACED BETWEEN SCRIM LAYERS WHERE THEY OVERLAP TO ENSURE A PROPER BOND.
- D. REFER TO PERMAFLASH APPLICATION INSTRUCTIONS FOR GENERAL GUIDELINES REGARDING THE PERMAFLASH SYSTEM.

Johns Manville is a manufacturer of commercial roofing products and offers this general conceptual information to you as a courtesy. This complimentary assistance is not to be used or relied upon by anyone as a substitute for professional engineering design and documentation required by building code, contract, or applicable law. By accepting these comments you agree they do not constitute any representations, endorsements of, or an assumption by Johns Manville of any liability for either the adequacy of design of this building or any other material not supplied by Johns Manville.

Note: For the most current information on general guidelines, please refer to the System Considerations tab under Commercial Roofing Products on the JM Roofing Web site. For specifications, flashing details and general installation information please refer to the Application Tools tab.

Refer to the Safe Use Instructions and product label prior to using this product.



PermaFlash® Drain Scrim Detail

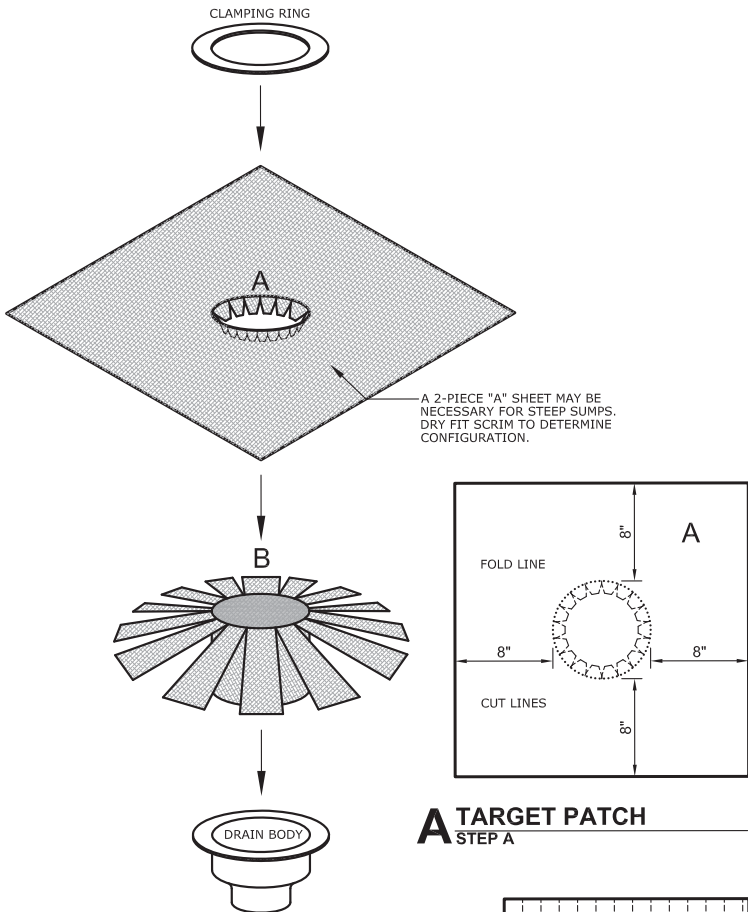

A TARGET PATCH
STEP A

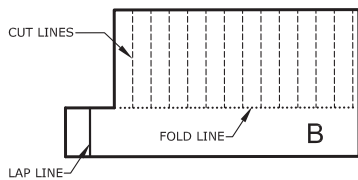

B DRAIN INSERT
STEP B

NOTES:

- A. USE SCRIM DETAIL IN CONJUNCTION WITH THE PERMAFLASH LAYOUT DRAWING, PMF-5.
- B. EMBED ALL PRE-CUT SCRIM INTO A FULL WET BASE COAT OF MBR FLASHING CEMENT. ALLOW EACH COAT TO FULLY CURE BEFORE APPLICATION OF SUBSEQUENT COATS.
- C. ENCAPSULATE ALL SCRIM COMPLETELY WITH A MINIMUM OF A 60 MIL COVERING.
- D. ALL FOLD LINES REPRESENTED AS ALL CUT LINES REPRESENTED AS - - - - -

Johns Manville is a manufacturer of commercial roofing products and offers this general conceptual information to you as a courtesy. This complimentary assistance is not to be used or relied upon by anyone as a substitute for professional engineering design and documentation required by building code, contract, or applicable law. By accepting these comments you agree they do not constitute any representations, endorsements of, or an assumption by Johns Manville of any liability for either the adequacy of design of this building or any other material not supplied by Johns Manville.

Note: For the most current information on general guidelines, please refer to the System Considerations tab under Commercial Roofing Products on the JM Roofing Web site. For specifications, flashing details and general installation information please refer to the Application Tools tab.

Refer to the Safe Use Instructions and product label prior to using this product.



PermaFlash® Through-Wall Scupper Detail

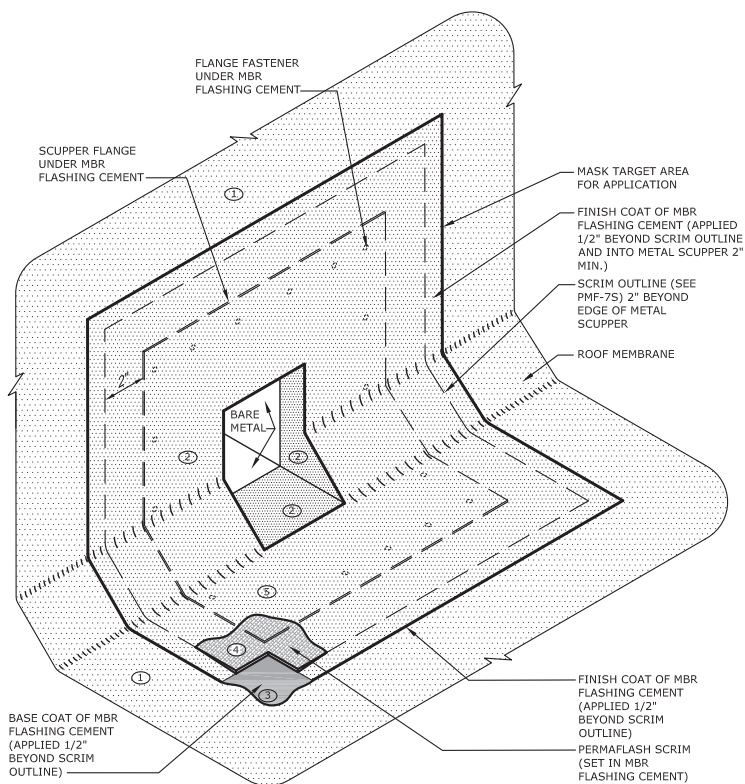

NOTES:

- A. USE THIS DETAIL IN CONJUNCTION WITH THE PERMAFLASH THROUGH WALL SCUPPER SCRIM LAYOUT, DRAWING PMF-7S.
- B. ENSURE TOTAL TARGET AREA OF FLASHING IS NO LESS THAN 16" x 16".
- C. AN EXTRA COAT OF MBR FLASHING CEMENT MUST BE PLACED BETWEEN SCRIM LAYERS WHERE THEY OVERLAP TO ENSURE A PROPER BOND.
- D. REFER TO PERMAFLASH APPLICATION INSTRUCTIONS FOR GENERAL GUIDELINES REGARDING THE PERMAFLASH SYSTEM.

ASSEMBLY

- ① MASK TARGET AREA ON ROOF MEMBRANE AND PENETRATION.
- ② CLEAN & PRIME ALL NON-POROUS AREAS (METAL, ETC.) REQUIRING LIQUID MEMBRANE WITH PERMAFLASH PRIMER.
- ③ APPLY 30 MIL. BASE COAT OF MBR FLASHING CEMENT WITHIN TARGET AREA. (A BRUSH WORKS BEST).
- ④ EMBED SCRIM(S) INTO WET BASE COAT OF MBR FLASHING CEMENT, 1/2" SHORT OF TARGET AREA.
- ⑤ IMMEDIATELY AFTER EMBEDDING THE SCRIM, APPLY 60 MIL. FINISH COAT OF MBR FLASHING CEMENT OVER SCRIM AND 1/2" BEYOND, ENSURING SCRIM IS COMPLETELY EMBEDDED.
- ⑥ REMOVE MASKING TAPE IMMEDIATELY AFTER APPLICATION OF FINISH COAT.

Johns Manville is a manufacturer of commercial roofing products and offers this general conceptual information to you as a courtesy. This complimentary assistance is not to be used or relied upon by anyone as a substitute for professional engineering design and documentation required by building code, contract, or applicable law. By accepting these comments you agree they do not constitute any representations, endorsements of, or an assumption by Johns Manville of any liability for either the adequacy of design of this building or any other material not supplied by Johns Manville.

Note: For the most current information on general guidelines, please refer to the System Considerations tab under Commercial Roofing Products on the JM Roofing Web site. For specifications, flashing details and general installation information please refer to the Application Tools tab.

Refer to the Safe Use Instructions and product label prior to using this product.



PermaFlash® Through-Wall Scupper Scrim Detail

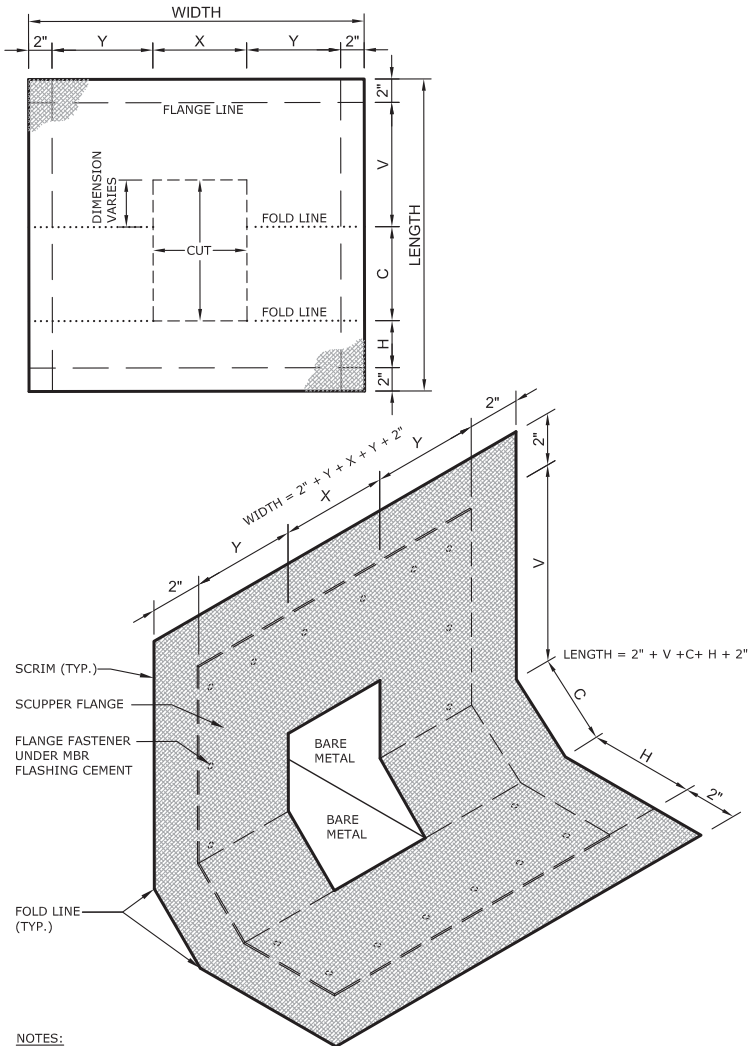

NOTES:

- A. USE SCRIM DETAIL IN CONJUNCTION WITH THE THROUGH WALL SCUPPER DETAIL DRAWING, PMF-7.
- B. ALL FOLD LINES REPRESENTED AS ALL CUT LINES REPRESENTED AS - - - - -
- C. AN EXTRA COAT OF MBR FLASHING CEMENT MUST BE PLACED BETWEEN SCRIM LAYERS WHERE THEY OVERLAP TO ENSURE A PROPER BOND.

Johns Manville is a manufacturer of commercial roofing products and offers this general conceptual information to you as a courtesy. This complimentary assistance is not to be used or relied upon by anyone as a substitute for professional engineering design and documentation required by building code, contract, or applicable law. By accepting these comments you agree they do not constitute any representations, endorsements of, or an assumption by Johns Manville of any liability for either the adequacy of design of this building or any other material not supplied by Johns Manville.

Note: For the most current information on general guidelines, please refer to the System Considerations tab under Commercial Roofing Products on the JM Roofing Web site. For specifications, flashing details and general installation information please refer to the Application Tools tab.

Refer to the Safe Use Instructions and product label prior to using this product.



PermaFlash® Overflow Scupper Scrim Detail

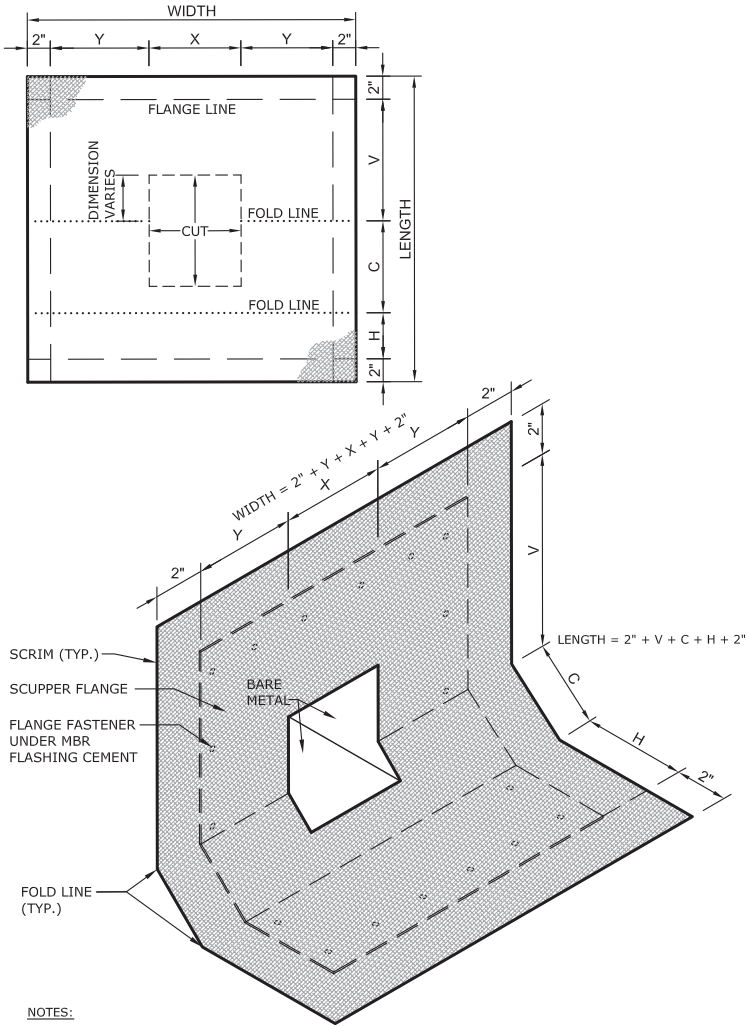

NOTES:

- A. USE SCRIM DETAIL IN CONJUNCTION WITH THE OVERFLOW SCUPPER DETAIL DRAWING, PMF-8.
- B. ALL FOLD LINES REPRESENTED AS ALL CUT LINES REPRESENTED AS
- C. AN EXTRA COAT OF MBR FLASHING CEMENT MUST BE PLACED BETWEEN SCRIM LAYERS WHERE THEY OVERLAP TO ENSURE A PROPER BOND.

Johns Manville is a manufacturer of commercial roofing products and offers this general conceptual information to you as a courtesy. This complimentary assistance is not to be used or relied upon by anyone as a substitute for professional engineering design and documentation required by building code, contract, or applicable law. By accepting these comments you agree they do not constitute any representations, endorsements of, or an assumption by Johns Manville of any liability for either the adequacy of design of this building or any other material not supplied by Johns Manville.

Note: For the most current information on general guidelines, please refer to the System Considerations tab under Commercial Roofing Products on the JM Roofing Web site. For specifications, flashing details and general installation information please refer to the Application Tools tab.

Refer to the Safe Use Instructions and product label prior to using this product.



PermaFlash® I-Beam Detail

ASSEMBLY

- ① MASK TARGET AREA ON ROOF MEMBRANE AND PENETRATION.
- ② CLEAN & PRIME ALL NON-POROUS AREAS (METAL, ETC.) REQUIRING LIQUID MEMBRANE WITH PERMAFLASH PRIMER.
- ③ APPLY 30 MIL. BASE COAT OF MBR FLASHING CEMENT WITHIN TARGET AREA. (A BRUSH WORKS BEST).
- ④ EMBED SCRIM(S) INTO WET BASE COAT OF MBR FLASHING CEMENT, 1/2" SHORT OF TARGET AREA.
- ⑤ IMMEDIATELY AFTER EMBEDDING THE SCRIM, APPLY 60 MIL. FINISH COAT OF MBR FLASHING CEMENT OVER SCRIM AND 1/2" BEYOND, ENSURING SCRIM IS COMPLETELY EMBEDDED.
- ⑥ REMOVE MASKING TAPE IMMEDIATELY AFTER APPLICATION OF FINISH COAT.

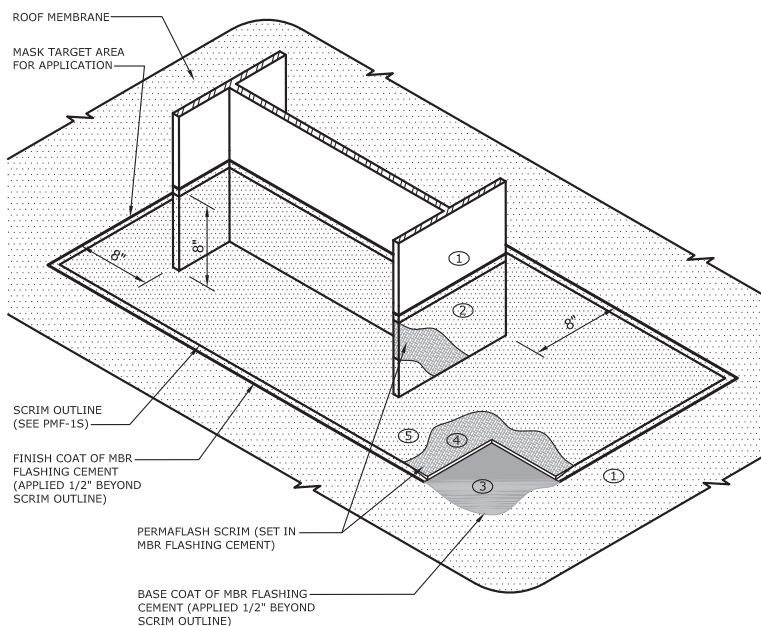

NOTES:

1. USE THIS DETAIL IN CONJUNCTION WITH THE PERMAFLASH I-BEAM SCRIM LAYOUT, DRAWING PMF-1S.
2. ENSURE TOTAL TARGET AREA OF FLASHING IS NO LESS THAN 16' x 16'.
3. AN EXTRA COAT OF MBR FLASHING CEMENT MUST BE PLACED BETWEEN SCRIM LAYERS WHERE THEY OVERLAP TO ENSURE A PROPER BOND.
4. REFER TO PERMAFLASH APPLICATION INSTRUCTIONS FOR GENERAL GUIDELINES REGARDING THE PERMAFLASH SYSTEM.

Johns Manville is a manufacturer of commercial roofing products and offers this general conceptual information to you as a courtesy. This complimentary assistance is not to be used or relied upon by anyone as a substitute for professional engineering design and documentation required by building code, contract, or applicable law. By accepting these comments you agree they do not constitute any representations, endorsements of, or an assumption by Johns Manville of any liability for either the adequacy of design of this building or any other material not supplied by Johns Manville.

Note: For the most current information on general guidelines, please refer to the System Considerations tab under Commercial Roofing Products on the JM Roofing Web site. For specifications, flashing details and general installation information please refer to the Application Tools tab.

Refer to the Safe Use Instructions and product label prior to using this product.



PermaFlash® Square Metal Tube Detail

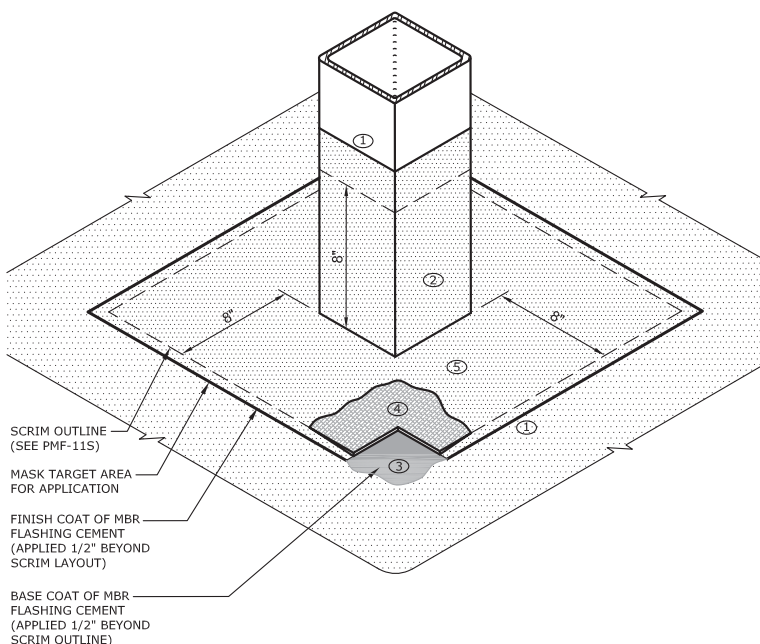

NOTES:

- A. USE THIS DETAIL IN CONJUNCTION WITH THE PERMAFLASH SQUARE METAL TUBE SCRIM LAYOUT, DRAWING PMF-11S.
- B. ENSURE TOTAL TARGET AREA OF FLASHING IS NO LESS THAN 16" x 16".
- C. AN EXTRA COAT OF MBR FLASHING CEMENT MUST BE PLACED BETWEEN SCRIM LAYERS WHERE THEY OVERLAP TO ENSURE A PROPER BOND.
- D. REFER TO PERMAFLASH APPLICATION INSTRUCTIONS FOR GENERAL GUIDELINES REGARDING THE PERMAFLASH SYSTEM.

ASSEMBLY

- ① MASK TARGET AREA ON ROOF MEMBRANE.
- ② CLEAN & PRIME ALL NON-POROUS AREAS (METAL, ETC.) REQUIRING LIQUID MEMBRANE WITH PERMAFLASH PRIMER.
- ③ APPLY 30 MIL. BASE COAT OF MBR FLASHING CEMENT WITHIN TARGET AREA. (A BRUSH WORKS BEST).
- ④ EMBED SCRIM(S) INTO WET BASE COAT OF MBR FLASHING CEMENT, 1/2" SHORT OF TARGET AREA.
- ⑤ IMMEDIATELY AFTER EMBEDDING THE SCRIM, APPLY 60 MIL. FINISH COAT OF MBR FLASHING CEMENT OVER SCRIM AND 1/2" BEYOND, ENSURING SCRIM IS COMPLETELY EMBEDDED.
- ⑥ REMOVE MASKING TAPE IMMEDIATELY AFTER APPLICATION OF FINISH COAT.

Johns Manville is a manufacturer of commercial roofing products and offers this general conceptual information to you as a courtesy. This complimentary assistance is not to be used or relied upon by anyone as a substitute for professional engineering design and documentation required by building code, contract, or applicable law. By accepting these comments you agree they do not constitute any representations, endorsements of, or an assumption by Johns Manville of any liability for either the adequacy of design of this building or any other material not supplied by Johns Manville.

Note: For the most current information on general guidelines, please refer to the System Considerations tab under Commercial Roofing Products on the JM Roofing Web site. For specifications, flashing details and general installation information please refer to the Application Tools tab.

Refer to the Safe Use Instructions and product label prior to using this product.



PermaFlash® Square Metal Tube Scrim Detail

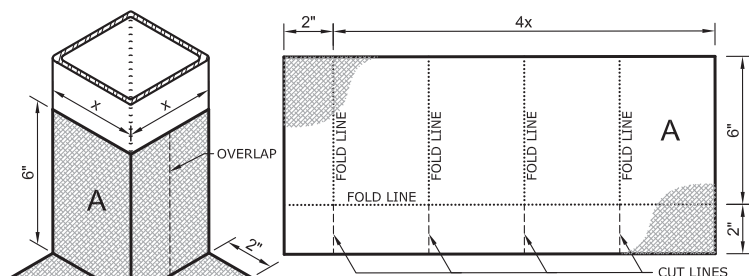

A VERTICAL SURFACES
STEP A

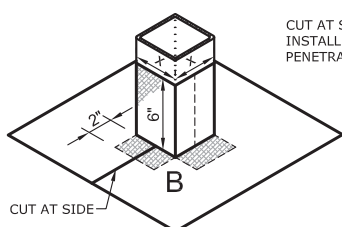

HALF SCALE

B HORIZONTAL SURFACE
STEP B

NOTES:

- A. USE SCRIM LAYOUT IN CONJUNCTION WITH THE PERMAFLASH SQUARE METAL TUBE DETAIL DRAWING, PMF-11.
- B. ALL FOLD LINES REPRESENTED AS
ALL CUT LINES REPRESENTED AS - - - - -
- C. AN EXTRA COAT OF MBR FLASHING CEMENT MUST BE PLACED BETWEEN SCRIM LAYERS WHERE THEY OVERLAP TO ENSURE A PROPER BOND.

Johns Manville is a manufacturer of commercial roofing products and offers this general conceptual information to you as a courtesy. This complimentary assistance is not to be used or relied upon by anyone as a substitute for professional engineering design and documentation required by building code, contract, or applicable law. By accepting these comments you agree they do not constitute any representations, endorsements of, or an assumption by Johns Manville of any liability for either the adequacy of design of this building or any other material not supplied by Johns Manville.

Note: For the most current information on general guidelines, please refer to the System Considerations tab under Commercial Roofing Products on the JM Roofing Web site. For specifications, flashing details and general installation information please refer to the Application Tools tab.

Refer to the Safe Use Instructions and product label prior to using this product.



PermaFlash® I-Beam Scrim Detail

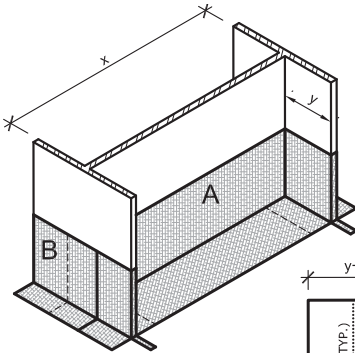

VERTICAL SURFACES STEPS A & B

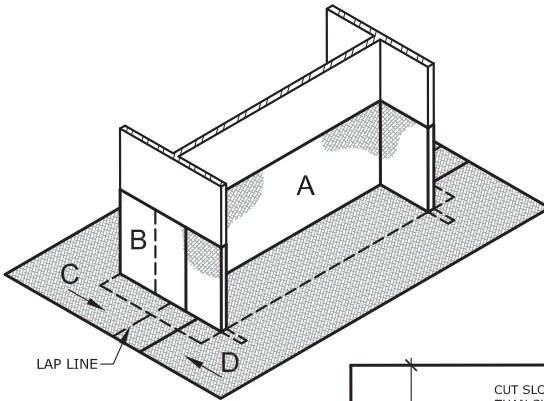
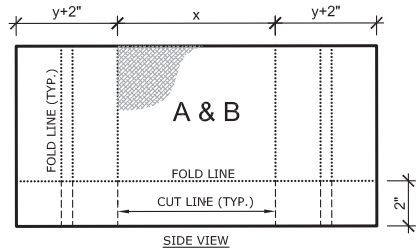

HORIZONTAL SURFACES STEPS C & D

NOTES:

- A. USE SCRIM LAYOUT IN CONJUNCTION WITH THE PERMAFLASH I-BEAM DETAIL DRAWING, PMF-1.
- B. ALL FOLD LINES SHOWN AS ALL CUT LINES SHOWN AS - - - - -
- C. AN EXTRA COAT OF MBR FLASHING CEMENT MUST BE PLACED BETWEEN SCRIM LAYERS WHERE THEY OVERLAP TO ENSURE A PROPER BOND.

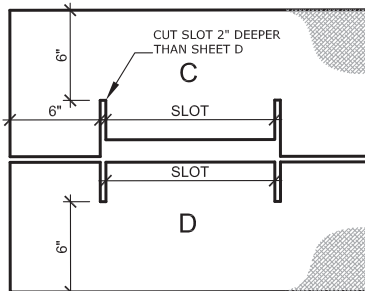

Johns Manville is a manufacturer of commercial roofing products and offers this general conceptual information to you as a courtesy. This complimentary assistance is not to be used or relied upon by anyone as a substitute for professional engineering design and documentation required by building code, contract, or applicable law. By accepting these comments you agree they do not constitute any representations, endorsements of, or an assumption by Johns Manville of any liability for either the adequacy of design of this building or any other material not supplied by Johns Manville.

Note: For the most current information on general guidelines, please refer to the System Considerations tab under Commercial Roofing Products on the JM Roofing Web site. For specifications, flashing details and general installation information please refer to the Application Tools tab.

Refer to the Safe Use Instructions and product label prior to using this product.



PermaFlash® Angle Iron Detail

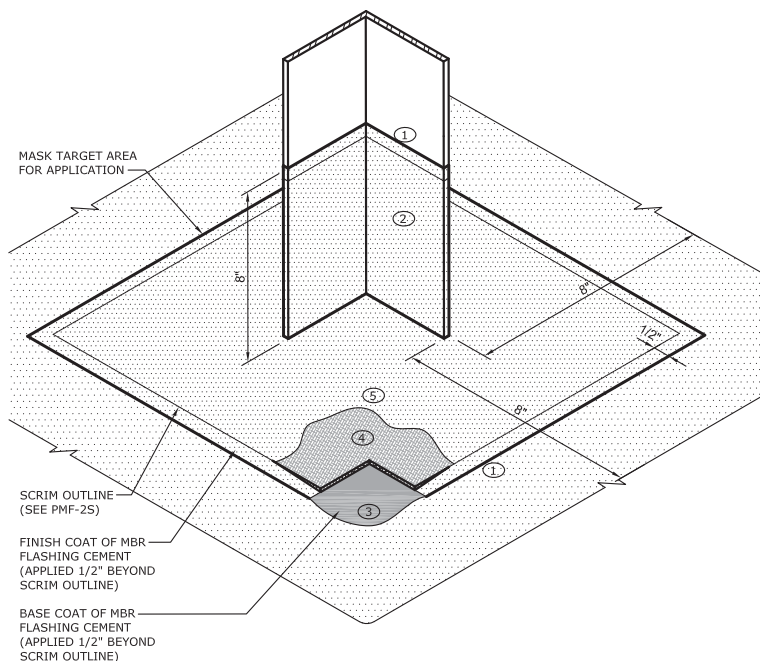

NOTES:

- A. USE THIS DETAIL IN CONJUNCTION WITH THE PERMAFLASH ANGLE IRON SCRIM LAYOUT, DRAWING PMF-2S.
- B. ENSURE TOTAL TARGET AREA OF FLASHING IS NO LESS THAN 16" x 16".
- C. AN EXTRA COAT OF MBR FLASHING CEMENT MUST BE PLACED BETWEEN SCRIM LAYERS WHERE THEY OVERLAP TO ENSURE A PROPER BOND.
- D. REFER TO PERMAFLASH APPLICATION INSTRUCTIONS FOR GENERAL GUIDELINES REGARDING THE PERMAFLASH SYSTEM.

ASSEMBLY

- ① MASK TARGET AREA ON ROOF MEMBRANE AND PENETRATION.
- ② CLEAN & PRIME ALL NON-POROUS AREAS (METAL, ETC...) REQUIRING LIQUID MEMBRANE WITH PERMAFLASH PRIMER.
- ③ APPLY 30 MIL. BASE COAT OF MBR FLASHING CEMENT WITHIN TARGET AREA. (A BRUSH WORKS BEST).
- ④ EMBED SCRIM(S) INTO WET BASE COAT OF MBR FLASHING CEMENT, 1/2" SHORT OF TARGET AREA.
- ⑤ IMMEDIATELY AFTER EMBEDDING THE SCRIM, APPLY 60 MIL. FINISH COAT OF MBR FLASHING CEMENT OVER SCRIM AND 1/2" BEYOND, ENSURING SCRIM IS COMPLETELY EMBEDDED.
- ⑥ REMOVE MASKING TAPE IMMEDIATELY AFTER APPLICATION OF FINISH COAT.

Johns Manville is a manufacturer of commercial roofing products and offers this general conceptual information to you as a courtesy. This complimentary assistance is not to be used or relied upon by anyone as a substitute for professional engineering design and documentation required by building code, contract, or applicable law. By accepting these comments you agree they do not constitute any representations, endorsements of, or an assumption by Johns Manville of any liability for either the adequacy of design of this building or any other material not supplied by Johns Manville.

Note: For the most current information on general guidelines, please refer to the System Considerations tab under Commercial Roofing Products on the JM Roofing Web site. For specifications, flashing details and general installation information please refer to the Application Tools tab.

Refer to the Safe Use Instructions and product label prior to using this product.



PermaFlash® Angle Iron Scrim Detail

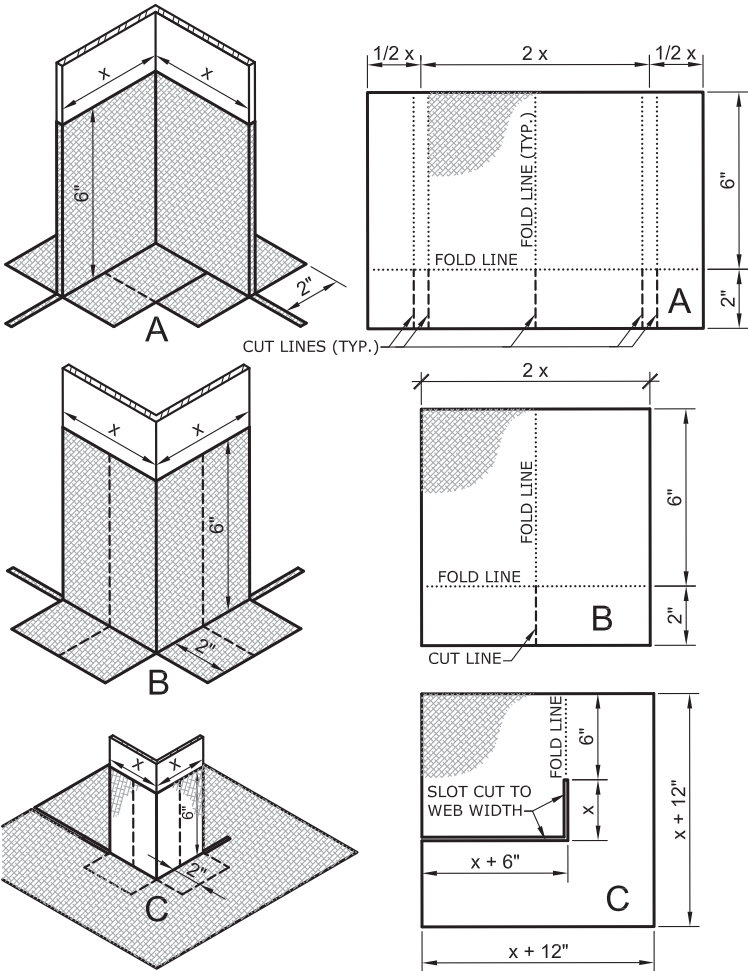

HALF SCALE

NOTES:

- A. USE SCRIM LAYOUT IN CONJUNCTION WITH THE PERMAFLASH ANGLE IRON DETAIL DRAWING, PMF-2.
- B. ALL FOLD LINES REPRESENTED AS ALL CUT LINES REPRESENTED AS - - - - -
- C. AN EXTRA COAT OF MBR FLASHING CEMENT MUST BE PLACED BETWEEN SCRIM LAYERS WHERE THEY OVERLAP TO ENSURE A PROPER BOND.

Johns Manville is a manufacturer of commercial roofing products and offers this general conceptual information to you as a courtesy. This complimentary assistance is not to be used or relied upon by anyone as a substitute for professional engineering design and documentation required by building code, contract, or applicable law. By accepting these comments you agree they do not constitute any representations, endorsements of, or an assumption by Johns Manville of any liability for either the adequacy of design of this building or any other material not supplied by Johns Manville.

Note: For the most current information on general guidelines, please refer to the System Considerations tab under Commercial Roofing Products on the JM Roofing Web site. For specifications, flashing details and general installation information please refer to the Application Tools tab.

Refer to the Safe Use Instructions and product label prior to using this product.



PermaFlash® Pipe Penetration Detail

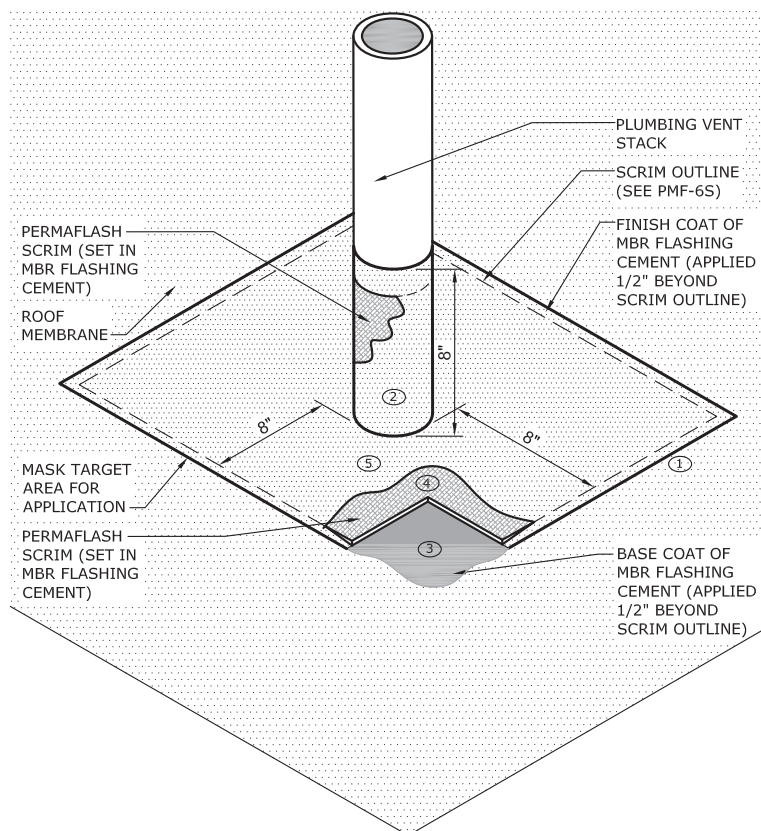

NOTES:

- A. USE THIS DETAIL IN CONJUNCTION WITH THE PERMAFLASH PIPE PENETRATION SCRIM LAYOUT, DRAWING PMF-6S.
- B. ENSURE TOTAL TARGET AREA OF FLASHING IS NO LESS THAN 16" x 16".
- C. AN EXTRA COAT OF MBR FLASHING CEMENT MUST BE PLACED BETWEEN SCRIM LAYERS WHERE THEY OVERLAP TO ENSURE A PROPER BOND.
- D. REFER TO PERMAFLASH APPLICATION INSTRUCTIONS FOR GENERAL GUIDELINES REGARDING THE PERMAFLASH SYSTEM.

ASSEMBLY

- ① MASK TARGET AREA ON ROOF MEMBRANE AND PENETRATION.
- ② CLEAN & PRIME ALL NON-POROUS AREAS (METAL, ETC.) REQUIRING LIQUID MEMBRANE WITH PERMAFLASH PRIMER.
- ③ APPLY 30 MIL. BASE COAT OF MBR FLASHING CEMENT WITHIN TARGET AREA. (A BRUSH WORKS BEST).
- ④ EMBED SCRIM(S) INTO WET BASE COAT OF MBR FLASHING CEMENT, 1/2" SHORT OF TARGET AREA.
- ⑤ IMMEDIATELY AFTER EMBEDDING THE SCRIM, APPLY 60 MIL. FINISH COAT OF MBR FLASHING CEMENT OVER SCRIM AND 1/2" BEYOND, ENSURING SCRIM IS COMPLETELY EMBEDDED.
- ⑥ REMOVE MASKING TAPE IMMEDIATELY AFTER

Johns Manville is a manufacturer of commercial roofing products and offers this general conceptual information to you as a courtesy. This complimentary assistance is not to be used or relied upon by anyone as a substitute for professional engineering design and documentation required by building code, contract, or applicable law. By accepting these comments you agree they do not constitute any representations, endorsements of, or an assumption by Johns Manville of any liability for either the adequacy of design of this building or any other material not supplied by Johns Manville.

Note: For the most current information on general guidelines, please refer to the System Considerations tab under Commercial Roofing Products on the JM Roofing Web site. For specifications, flashing details and general installation information please refer to the Application Tools tab.

Refer to the Safe Use Instructions and product label prior to using this product.



PermaFlash® Pipe Penetration Scrim Detail

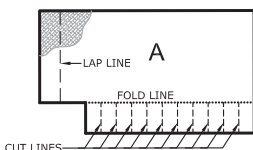
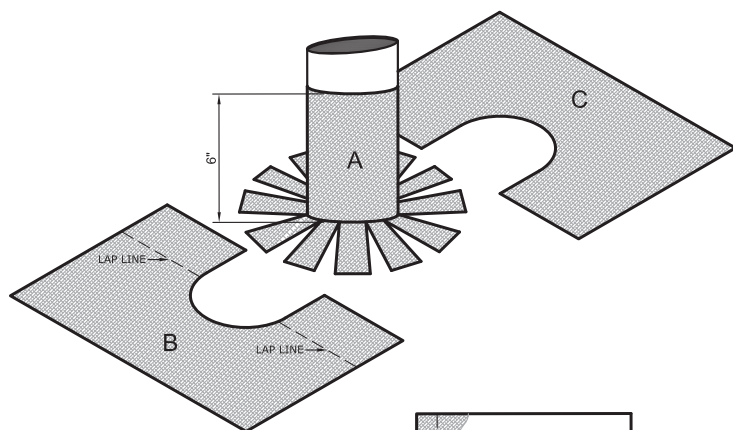

A FINGER CUTS
STEP A

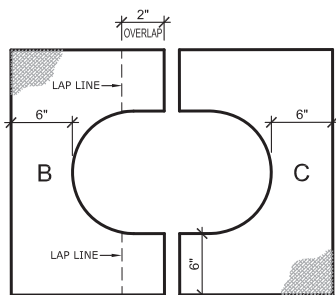

B & C TARGET REINFORCEMENT
STEP B & C

NOTES:

- A. USE SCRIM DETAIL IN CONJUNCTION WITH THE PERMAFLASH PIPE PENETRATION DETAIL DRAWING, PMF-6.
- B. ALL FOLD LINES REPRESENTED AS ALL CUT LINES REPRESENTED AS - - - - -
- C. AN EXTRA COAT OF MBR FLASHING CEMENT MUST BE PLACED BETWEEN SCRIM LAYERS WHERE THEY OVERLAP TO ENSURE A PROPER BOND.

Johns Manville is a manufacturer of commercial roofing products and offers this general conceptual information to you as a courtesy. This complimentary assistance is not to be used or relied upon by anyone as a substitute for professional engineering design and documentation required by building code, contract, or applicable law. By accepting these comments you agree they do not constitute any representations, endorsements of, or an assumption by Johns Manville of any liability for either the adequacy of design of this building or any other material not supplied by Johns Manville.

Note: For the most current information on general guidelines, please refer to the System Considerations tab under Commercial Roofing Products on the JM Roofing Web site. For specifications, flashing details and general installation information please refer to the Application Tools tab.

Refer to the Safe Use Instructions and product label prior to using this product.



Gravel Stop

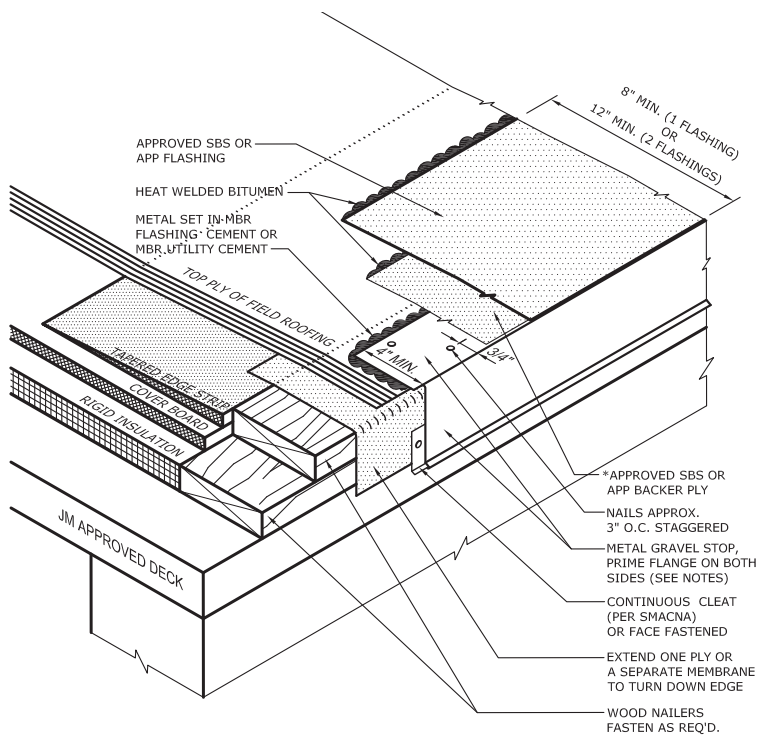

NOTES:

- SBS HEAT WELDED FLASHINGS CAN ONLY BE USED WITH SBS OR BUR SYSTEMS. APP HEAT WELDED FLASHINGS CAN ONLY BE USED WITH APP OR BUR SYSTEMS. (PLEASE REFER TO THE APPROPRIATE TABLE IN THE BITUMINOUS FLASHING SPECIFICATION INDICATING ACCEPTABLE FLASHING PRODUCTS FOR EACH OF THE SBS OR APP HEAT WELDED SYSTEMS.)
- *A BACKER PLY IS REQUIRED FOR EXTENDED TERM 25 AND 30 YEAR GUARANTEES.
- THE TAPERED EDGE STRIP (OPTIONAL), IS USED FOR NON-DRAINING EDGES TO KEEP PONDING WATER OFF THE FLASHING LAPS. IF THE EDGE IS DESIGNED TO EVACUATE WATER FROM THE ROOF, THE TAPERED EDGE STRIP IS ELIMINATED AND THE TOP OF THE WOOD NAILER WILL BE AT A HEIGHT FLUSH WITH THE TOP OF THE FLAT COVER BOARD OR SUBSTRATE.
- ANY CARPENTRY, METAL WORK, OR MASONRY CONSTRUCTION SHOULD BE DESIGNED AND CONSTRUCTED IN ACCORDANCE WITH LOCAL CODE REQUIREMENTS AND/OR PROJECT SPECIFICATIONS. THESE COMPONENTS SHOULD BE REVIEWED AND APPROVED BY A LICENSED DESIGN PROFESSIONAL.
- SHOP FABRICATED GRAVEL STOP SHOULD BE INSTALLED IN ACCORDANCE WITH SMACNA AND/OR NRCA GUIDELINES. LAPS SHALL UTILIZE EITHER APPROVED SPLICE PLATES OR 4" MINIMUM OVERLAPS WITH A APPROVED SEALANT.
- USE ASPHALT PRIMER ON GRAVEL STOP FLANGES WHEN USING MBR FLASHING CEMENT. USE PERMAFLASH PRIMER ON GRAVEL STOP FLANGES WHEN USING MBR FLASHING CEMENT.
- PLEASE SEE BITUMINOUS FLASHING SPECIFICATIONS FOR A FULL DESCRIPTION OF INSTALLATION INSTRUCTIONS AND REQUIREMENTS WHICH ARE CONSIDERED A PART OF THIS DETAIL.
- CAUTION: IMPROPER USE OF THESE MATERIALS AND APPLICATION EQUIPMENT CAN RESULT IN SEVERE BURNS, AND/ OR DAMAGE TO PROPERTY. THE MECHANIC MUST INSTALL THESE MATERIALS USING THE TECHNIQUES RECOMMENDED BY JM AND THOSE FOUND IN THE CERTIFIED ROOFING TORCH APPLICATOR (CERTA) PROGRAM AVAILABLE THROUGH THE NATIONAL ROOFING CONTRACTORS ASSOCIATION.

Johns Manville is a manufacturer of commercial roofing products and offers this general conceptual information to you as a courtesy. This complimentary assistance is not to be used or relied upon by anyone as a substitute for professional engineering design and documentation required by building code, contract, or applicable law. By accepting these comments you agree they do not constitute any representations, endorsements of, or an assumption by Johns Manville of any liability for either the adequacy of design of this building or any other material not supplied by Johns Manville.

Note: For the most current information on general guidelines, please refer to the System Considerations tab under Commercial Roofing Products on the JM Roofing Web site. For specifications, flashing details and general installation information please refer to the Application Tools tab.

Refer to the Safe Use Instructions and product label prior to using this product.



Gravel Stop Alternate

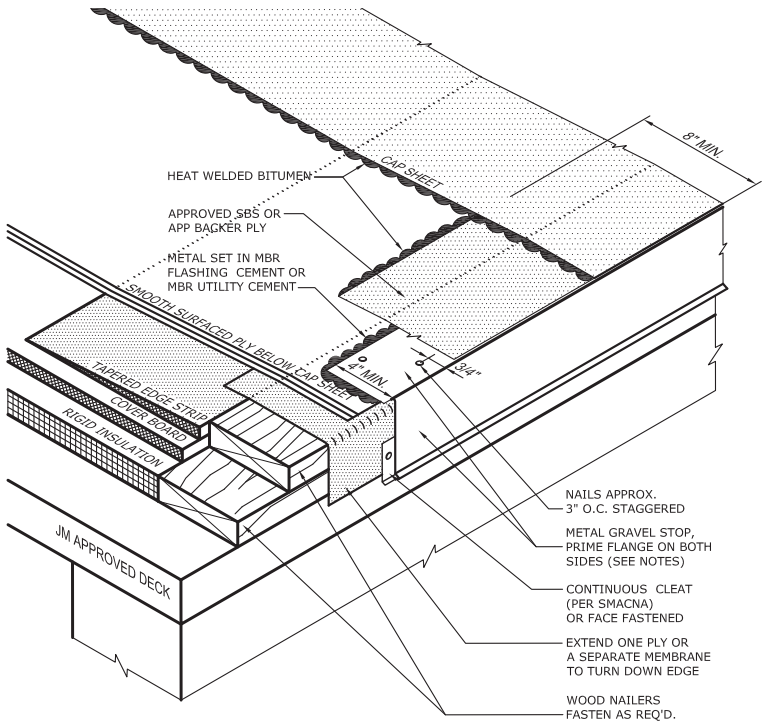

NOTES:

1. SBS HEAT WELDED FLASHINGS CAN ONLY BE USED WITH SBS OR BUR SYSTEMS. APP HEAT WELDED FLASHINGS CAN ONLY BE USED WITH APP OR BUR SYSTEMS. (PLEASE REFER TO THE APPROPRIATE TABLE IN THE BITUMINOUS FLASHING SPECIFICATION INDICATING ACCEPTABLE FLASHING PRODUCTS FOR EACH OF THE SBS OR APP HEAT WELDED SYSTEMS.)
2. THE TAPERED EDGE STRIP (OPTIONAL), IS USED FOR NON-DRAINING EDGES TO KEEP PONDING WATER OFF THE FLASHING LAPS. IF THE EDGE IS DESIGNED TO EVACUATE WATER FROM THE ROOF, THE TAPERED EDGE STRIP IS ELIMINATED AND THE TOP OF THE WOOD NAILER WILL BE AT A HEIGHT FLUSH WITH THE TOP OF THE FLAT COVER BOARD OR SUBSTRATE.
3. ANY CARPENTRY, METAL WORK, OR MASONRY CONSTRUCTION SHOULD BE DESIGNED AND CONSTRUCTED IN ACCORDANCE WITH LOCAL CODE REQUIREMENTS AND/OR PROJECT SPECIFICATIONS. THESE COMPONENTS SHOULD BE REVIEWED AND APPROVED BY A LICENSED DESIGN PROFESSIONAL.
4. SHOP FABRICATED GRAVEL STOP SHOULD BE INSTALLED IN ACCORDANCE WITH SMACNA AND/OR NRCA GUIDELINES. LAPS SHALL UTILIZE EITHER APPROVED SPLICE PLATES OR 4" MINIMUM OVERLAPS WITH A APPROVED SEALANT.
5. USE ASPHALT PRIMER ON GRAVEL STOP FLANGES WHEN USING MBR UTILITY CEMENT. USE PERMAFLASH PRIMER ON GRAVEL STOP FLANGES WHEN USING MBR FLASHING CEMENT.
6. PLEASE SEE BITUMINOUS FLASHING SPECIFICATIONS FOR A FULL DESCRIPTION OF INSTALLATION INSTRUCTIONS AND REQUIREMENTS WHICH ARE CONSIDERED A PART OF THIS DETAIL
7. CAUTION: IMPROPER USE OF THESE MATERIALS AND APPLICATION EQUIPMENT CAN RESULT IN SEVERE BURNS, AND/OR DAMAGE TO PROPERTY. THE MECHANIC MUST INSTALL THESE MATERIALS USING THE TECHNIQUES RECOMMENDED BY JM AND THOSE FOUND IN THE CERTIFIED ROOFING TORCH APPLICATOR (CERTA) PROGRAM AVAILABLE THROUGH THE NATIONAL ROOFING CONTRACTORS ASSOCIATION.

Johns Manville is a manufacturer of commercial roofing products and offers this general conceptual information to you as a courtesy. This complimentary assistance is not to be used or relied upon by anyone as a substitute for professional engineering design and documentation required by building code, contract, or applicable law. By accepting these comments you agree they do not constitute any representations, endorsements of, or an assumption by Johns Manville of any liability for either the adequacy of design of this building or any other material not supplied by Johns Manville.

Note: For the most current information on general guidelines, please refer to the System Considerations tab under Commercial Roofing Products on the JM Roofing Web site. For specifications, flashing details and general installation information please refer to the Application Tools tab.

Refer to the Safe Use Instructions and product label prior to using this product.



Gutter

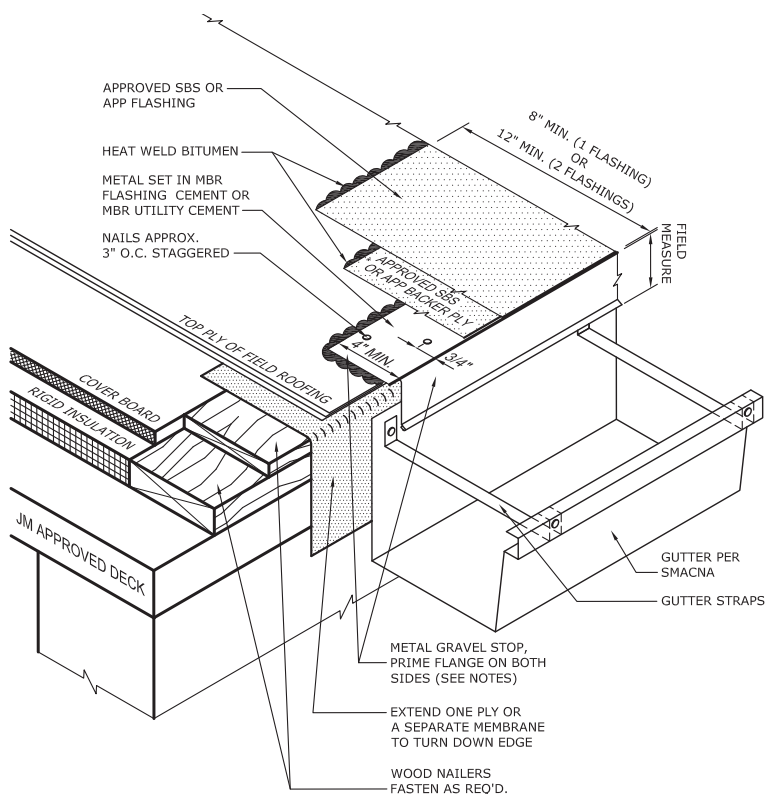

NOTES:

1. SBS HEAT WELDED FLASHINGS CAN ONLY BE USED WITH SBS OR BUR SYSTEMS. APP HEAT WELDED FLASHINGS CAN ONLY BE USED WITH APP OR BUR SYSTEMS. (PLEASE REFER TO THE APPROPRIATE TABLE IN THE BITUMINOUS FLASHING SPECIFICATION INDICATING ACCEPTABLE FLASHING PRODUCTS FOR EACH OF THE SBS OR APP HEAT WELDED SYSTEMS.)
2. *A BACKER PLY IS REQUIRED FOR EXTENDED TERM 25 AND 30 YEAR GUARANTEES.
3. ANY CARPENTRY, METAL WORK, OR MASONRY CONSTRUCTION SHOULD BE DESIGNED AND CONSTRUCTED IN ACCORDANCE WITH LOCAL CODE REQUIREMENTS AND/OR PROJECT SPECIFICATIONS. THESE COMPONENTS SHOULD BE REVIEWED AND APPROVED BY A LICENSED DESIGN PROFESSIONAL.
4. SHOP FABRICATED GRAVEL STOP SHOULD BE INSTALLED IN ACCORDANCE WITH SMACNA AND/OR NRCA GUIDELINES. LAPS SHALL UTILIZE EITHER APPROVED SPLICE PLATES OR 4" MINIMUM OVERLAPS WITH A APPROVED SEALANT.
5. USE ASPHALT PRIMER ON GRAVEL STOP FLANGES WHEN USING MBR UTILITY CEMENT. USE PERMAFLASH PRIMER ON GRAVEL STOP FLANGES WHEN USING MBR FLASHING CEMENT.
6. PLEASE SEE BITUMINOUS FLASHING SPECIFICATIONS FOR A FULL DESCRIPTION OF INSTALLATION INSTRUCTIONS AND REQUIREMENTS WHICH ARE CONSIDERED A PART OF THIS DETAIL.
7. CAUTION: IMPROPER USE OF THESE MATERIALS AND APPLICATION EQUIPMENT CAN RESULT IN SEVERE BURNS, AND/ OR DAMAGE TO PROPERTY. THE MECHANIC MUST INSTALL THESE MATERIALS USING THE TECHNIQUES RECOMMENDED BY JM AND THOSE FOUND IN THE CERTIFIED ROOFING TORCH APPLICATOR (CERTA) PROGRAM AVAILABLE THROUGH THE NATIONAL ROOFING CONTRACTORS ASSOCIATION.

Johns Manville is a manufacturer of commercial roofing products and offers this general conceptual information to you as a courtesy. This complimentary assistance is not to be used or relied upon by anyone as a substitute for professional engineering design and documentation required by building code, contract, or applicable law. By accepting these comments you agree they do not constitute any representations, endorsements of, or an assumption by Johns Manville of any liability for either the adequacy of design of this building or any other material not supplied by Johns Manville.

Note: For the most current information on general guidelines, please refer to the System Considerations tab under Commercial Roofing Products on the JM Roofing Web site. For specifications, flashing details and general installation information please refer to the Application Tools tab.

Refer to the Safe Use Instructions and product label prior to using this product.



Presto Lock Fascia System

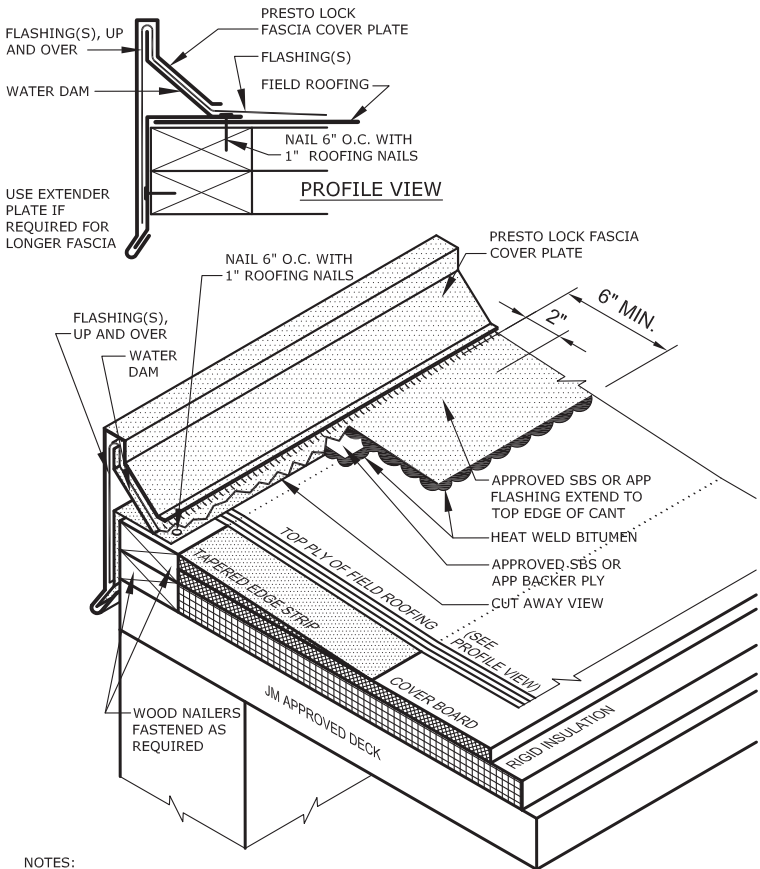

NOTES:

1. SBS HEAT WELDED FLASHINGS CAN ONLY BE USED WITH SBS OR BUR SYSTEMS. APP HEAT WELDED FLASHINGS CAN ONLY BE USED WITH APP OR BUR SYSTEMS. (PLEASE REFER TO THE APPROPRIATE TABLE IN THE BITUMINOUS FLASHING SPECIFICATION INDICATING ACCEPTABLE FLASHING PRODUCTS FOR EACH OF THE SBS OR APP HEAT WELDED SYSTEMS.)
2. THE TAPERED EDGE STRIP (OPTIONAL), IS USED FOR NON-DRAINING EDGES TO KEEP PONDING WATER OFF THE FLASHING LAPS OR TO TRANSITION SUBSTRATE FLUSH WITH PERIMETER NAILER HEIGHT.
3. ANY CARPENTRY, METAL WORK, OR MASONRY CONSTRUCTION SHOULD BE DESIGNED AND CONSTRUCTED IN ACCORDANCE WITH LOCAL CODE REQUIREMENTS AND/OR PROJECT SPECIFICATIONS. THESE COMPONENTS SHOULD BE REVIEWED AND APPROVED BY A LICENSED DESIGN PROFESSIONAL.
4. PRESTO LOCK GRAVEL STOP SHOULD BE INSTALLED IN ACCORDANCE WITH INSTALLATION INSTRUCTIONS INCLUDED WITH THE PRODUCT. PREFABRICATED INSIDE/OUTSIDE CORNERS ARE AVAILABLE TO COMPLETE THE INSTALLATION.
5. PLEASE SEE BITUMINOUS FLASHING SPECIFICATIONS FOR A FULL DESCRIPTION OF INSTALLATION INSTRUCTIONS AND REQUIREMENTS WHICH ARE CONSIDERED A PART OF THIS DETAIL
6. CAUTION: IMPROPER USE OF THESE MATERIALS AND APPLICATION EQUIPMENT CAN RESULT IN SEVERE BURNS, AND/ OR DAMAGE TO PROPERTY. THE MECHANIC MUST INSTALL THESE MATERIALS USING THE TECHNIQUES RECOMMENDED BY JM AND THOSE FOUND IN THE CERTIFIED ROOFING TORCH APPLICATOR (CERTA) PROGRAM AVAILABLE THROUGH THE NATIONAL ROOFING CONTRACTORS ASSOCIATION.

Johns Manville is a manufacturer of commercial roofing products and offers this general conceptual information to you as a courtesy. This complimentary assistance is not to be used or relied upon by anyone as a substitute for professional engineering design and documentation required by building code, contract, or applicable law. By accepting these comments you agree they do not constitute any representations, endorsements of, or an assumption by Johns Manville of any liability for either the adequacy of design of this building or any other material not supplied by Johns Manville.

Note: For the most current information on general guidelines, please refer to the System Considerations tab under Commercial Roofing Products on the JM Roofing Web site. For specifications, flashing details and general installation information please refer to the Application Tools tab.

Refer to the Safe Use Instructions and product label prior to using this product.



Presto-Tite Edge Metal System

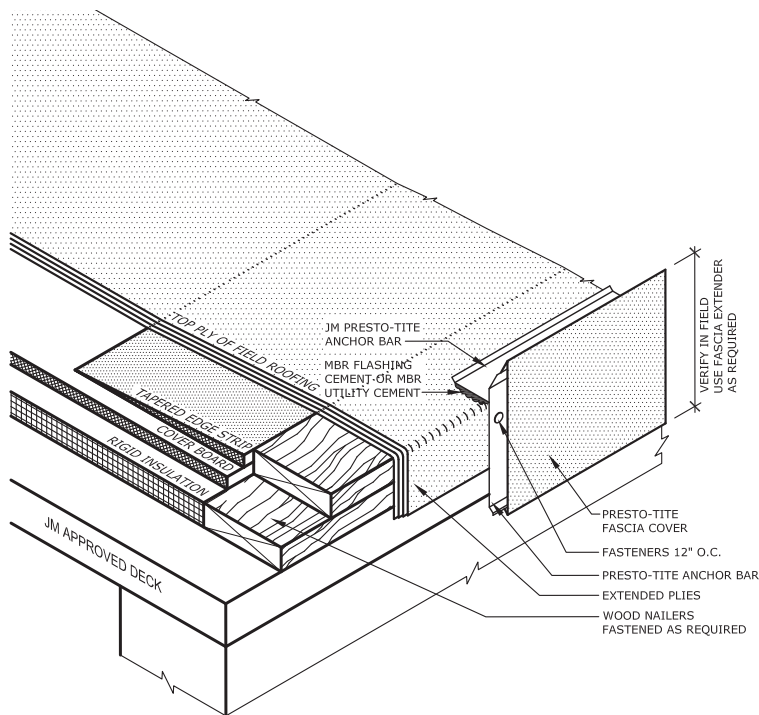

NOTES:

1. THE TAPERED EDGE STRIP (OPTIONAL), IS USED FOR NON-DRAINING EDGES TO KEEP PONDING WATER OFF THE FLASHING SEAL OR TO TRANSITION SUBSTRATE FLUSH WITH PERIMETER NAILER HEIGHT.
2. ANY CARPENTRY, METAL WORK, OR MASONRY CONSTRUCTION SHOULD BE DESIGNED AND CONSTRUCTED IN ACCORDANCE WITH LOCAL CODE REQUIREMENTS AND/OR PROJECT SPECIFICATIONS. THESE COMPONENTS SHOULD BE REVIEWED AND APPROVED BY A LICENSED DESIGN PROFESSIONAL.
3. PRESTO TITE GRAVEL STOP SHOULD BE INSTALLED IN ACCORDANCE WITH INSTALLATION INSTRUCTIONS INCLUDED WITH THE PRODUCT. PREFABRICATED INSIDE/OUTSIDE CORNERS ARE AVAILABLE TO COMPLETE THE INSTALLATION.
4. PLEASE SEE BITUMINOUS FLASHING SPECIFICATIONS FOR A FULL DESCRIPTION OF INSTALLATION INSTRUCTIONS AND REQUIREMENTS WHICH ARE CONSIDERED A PART OF THIS DETAIL
5. CAUTION: IMPROPER USE OF THESE MATERIALS AND APPLICATION EQUIPMENT CAN RESULT IN SEVERE BURNS, AND/ OR DAMAGE TO PROPERTY. THE MECHANIC MUST INSTALL THESE MATERIALS USING THE TECHNIQUES RECOMMENDED BY JM AND THOSE FOUND IN THE CERTIFIED ROOFING TORCH APPLICATOR (CERTA) PROGRAM AVAILABLE THROUGH THE NATIONAL ROOFING CONTRACTORS ASSOCIATION.

Johns Manville is a manufacturer of commercial roofing products and offers this general conceptual information to you as a courtesy. This complimentary assistance is not to be used or relied upon by anyone as a substitute for professional engineering design and documentation required by building code, contract, or applicable law. By accepting these comments you agree they do not constitute any representations, endorsements of, or an assumption by Johns Manville of any liability for either the adequacy of design of this building or any other material not supplied by Johns Manville.

Note: For the most current information on general guidelines, please refer to the System Considerations tab under Commercial Roofing Products on the JM Roofing Web site. For specifications, flashing details and general installation information please refer to the Application Tools tab.

Refer to the Safe Use Instructions and product label prior to using this product.



Raised Metal Cant Fascia

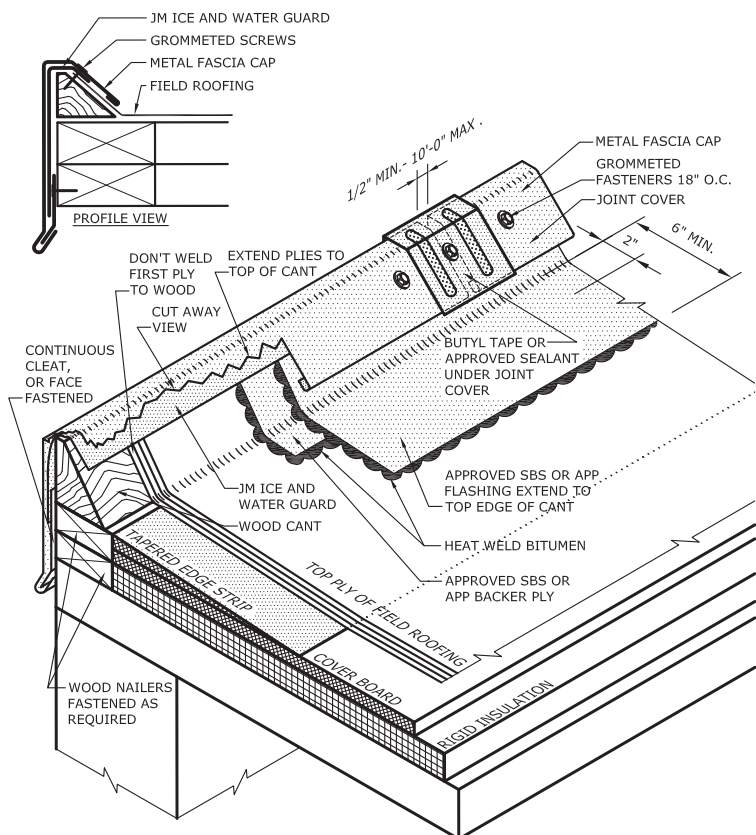

NOTES:

1. SBS HEAT WELDED FLASHINGS CAN ONLY BE USED WITH SBS OR BUR SYSTEMS. APP HEAT WELDED FLASHINGS CAN ONLY BE USED WITH APP OR BUR SYSTEMS. (PLEASE REFER TO THE APPROPRIATE TABLE IN THE BITUMINOUS FLASHING SPECIFICATION INDICATING ACCEPTABLE FLASHING PRODUCTS FOR EACH OF THE SBS OR APP HEAT WELDED SYSTEMS.)
2. THE TAPERED EDGE STRIP (OPTIONAL), IS USED FOR NON-DRAINING EDGES TO KEEP PONDING WATER OFF THE FLASHING LAPS OR TO TRANSITION SUBSTRATE FLUSH WITH PERIMETER NAILER HEIGHT.
3. ANY CARPENTRY, METAL WORK, OR MASONRY CONSTRUCTION SHOULD BE DESIGNED AND CONSTRUCTED IN ACCORDANCE WITH LOCAL CODE REQUIREMENTS AND/OR PROJECT SPECIFICATIONS. THESE COMPONENTS SHOULD BE REVIEWED AND APPROVED BY A LICENSED DESIGN PROFESSIONAL.
4. SHOP FABRICATED GRAVEL STOP SHOULD BE INSTALLED IN ACCORDANCE WITH SMACNA AND/OR NRCA GUIDELINES. LAPS SHALL UTILIZE EITHER APPROVED SPLICE PLATES OR 4" MINIMUM OVERLAPS WITH APPROVED SEALANT.
5. PLEASE SEE BITUMINOUS FLASHING SPECIFICATIONS FOR A FULL DESCRIPTION OF INSTALLATION INSTRUCTIONS AND REQUIREMENTS WHICH ARE CONSIDERED A PART OF THIS DETAIL
6. CAUTION: IMPROPER USE OF THESE MATERIALS AND APPLICATION EQUIPMENT CAN RESULT IN SEVERE BURNS, AND/OR DAMAGE TO PROPERTY. THE MECHANIC MUST INSTALL THESE MATERIALS USING THE TECHNIQUES RECOMMENDED BY JM AND THOSE FOUND IN THE CERTIFIED ROOFING TORCH APPLICATOR (CERTA) PROGRAM AVAILABLE THROUGH THE NATIONAL ROOFING CONTRACTORS ASSOCIATION.

Johns Manville is a manufacturer of commercial roofing products and offers this general conceptual information to you as a courtesy. This complimentary assistance is not to be used or relied upon by anyone as a substitute for professional engineering design and documentation required by building code, contract, or applicable law. By accepting these comments you agree they do not constitute any representations, endorsements of, or an assumption by Johns Manville of any liability for either the adequacy of design of this building or any other material not supplied by Johns Manville.

Note: For the most current information on general guidelines, please refer to the System Considerations tab under Commercial Roofing Products on the JM Roofing Web site. For specifications, flashing details and general installation information please refer to the Application Tools tab.

Refer to the Safe Use Instructions and product label prior to using this product.



Curb Mounted Roof-to-Roof Expansion Joint Cover

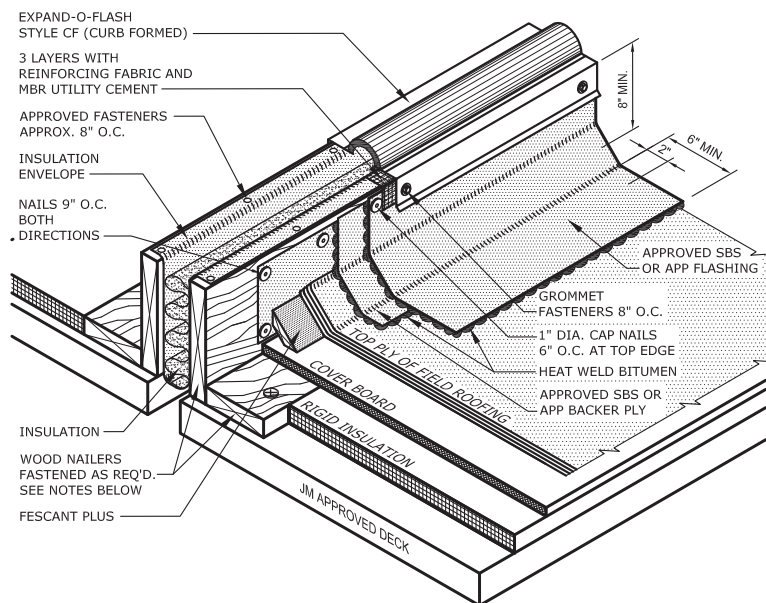

NOTES:

1. SBS HEAT WELDED FLASHINGS CAN ONLY BE USED WITH SBS OR BUR SYSTEMS. APP HEAT WELDED FLASHINGS CAN ONLY BE USED WITH APP OR BUR SYSTEMS. (PLEASE REFER TO THE APPROPRIATE TABLE IN THE BITUMINOUS FLASHING SPECIFICATION INDICATING ACCEPTABLE FLASHING PRODUCTS FOR EACH OF THE SBS OR APP HEAT WELDED SYSTEMS.)
2. THE VERTICAL WOOD CURB SHOULD BE FASTENED TO THE DECK ONLY.
3. INSTALL EXPAND-O-FLASH IN ACCORDANCE WITH APPLICATION INSTRUCTIONS INCLUDED WITH THE PRODUCT. PREFABRICATED TRANSITIONS, INSIDE/OUTSIDE CORNERS, ETC. ARE AVAILABLE TO COMPLETE THE INSTALLATION.
4. INSTALL PRESTO LOCK COPING IN ACCORDANCE WITH INSTALLATION INSTRUCTIONS INCLUDED WITH THE PRODUCT. PREFABRICATED INSIDE/OUTSIDE CORNERS AND END CAPS ARE AVAILABLE TO COMPLETE THE INSTALLATION. SHOP FABRICATED COPINGS SHOULD BE INSTALLED IN ACCORDANCE WITH SMACNA GUIDELINES.
5. ANY CARPENTRY, METAL WORK, OR MASONRY CONSTRUCTION SHOULD BE DESIGNED AND CONSTRUCTED IN ACCORDANCE WITH LOCAL CODE REQUIREMENTS AND/OR PROJECT SPECIFICATIONS. THESE COMPONENTS SHOULD BE REVIEWED AND APPROVED BY A LICENSED DESIGN PROFESSIONAL.
6. PLEASE SEE BITUMINOUS FLASHING SPECIFICATIONS FOR A FULL DESCRIPTION OF INSTALLATION INSTRUCTIONS AND REQUIREMENTS WHICH ARE CONSIDERED A PART OF THIS DETAIL
7. CAUTION: IMPROPER USE OF THESE MATERIALS AND APPLICATION EQUIPMENT CAN RESULT IN SEVERE BURNS, AND/ OR DAMAGE TO PROPERTY. THE MECHANIC MUST INSTALL THESE MATERIALS USING THE TECHNIQUES RECOMMENDED BY JM AND THOSE FOUND IN THE CERTIFIED ROOFING TORCH APPLICATOR (CERTA) PROGRAM AVAILABLE THROUGH THE NATIONAL ROOFING CONTRACTORS ASSOCIATION.

Johns Manville is a manufacturer of commercial roofing products and offers this general conceptual information to you as a courtesy. This complimentary assistance is not to be used or relied upon by anyone as a substitute for professional engineering design and documentation required by building code, contract, or applicable law. By accepting these comments you agree they do not constitute any representations, endorsements of, or an assumption by Johns Manville of any liability for either the adequacy of design of this building or any other material not supplied by Johns Manville.

Note: For the most current information on general guidelines, please refer to the System Considerations tab under Commercial Roofing Products on the JM Roofing Web site. For specifications, flashing details and general installation information please refer to the Application Tools tab.

Refer to the Safe Use Instructions and product label prior to using this product.



Curb to Wall E.J.

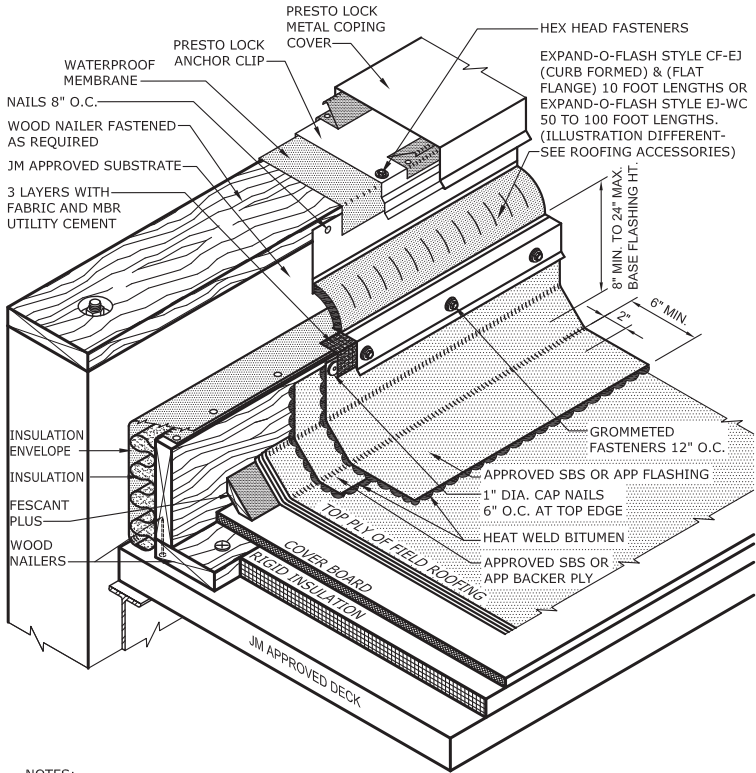

NOTES:

- SBS HEAT WELDED FLASHINGS CAN ONLY BE USED WITH SBS OR BUR SYSTEMS. APP HEAT WELDED FLASHINGS CAN ONLY BE USED WITH APP OR BUR SYSTEMS. (PLEASE REFER TO THE APPROPRIATE TABLE IN THE BITUMINOUS FLASHING SPECIFICATION INDICATING ACCEPTABLE FLASHING PRODUCTS FOR EACH OF THE SBS OR APP HEAT WELDED SYSTEMS.)
- VERTICAL JOINTS ARE TO BE OVERLAPPED 4" MINIMUM FOR ALL APPLICATIONS. 3 COURSING WITH MBR UTILITY CEMENT AND FABRIC OR JM MBR FLASHING CEMENT IS REQUIRED ON ALL VERTICAL FLASHING LAPS AND INSIDE/OUTSIDE CORNERS EXTENDING PAST LEADING EDGE OF CANT STRIP.
- ANY CARPENTRY, METAL WORK, OR MASONRY CONSTRUCTION SHOULD BE DESIGNED AND CONSTRUCTED IN ACCORDANCE WITH LOCAL CODE REQUIREMENTS AND/OR PROJECT SPECIFICATIONS. THESE COMPONENTS SHOULD BE REVIEWED AND APPROVED BY A LICENSED DESIGN PROFESSIONAL.
- INSTALL EXPAND-O-FLASH IN ACCORDANCE WITH APPLICATION INSTRUCTIONS INCLUDED WITH THE PRODUCT. PREFABRICATED TRANSITIONS, INSIDE/OUTSIDE CORNERS, ETC. ARE AVAILABLE TO COMPLETE THE INSTALLATION.
- INSTALL PRESTO LOCK COPING IN ACCORDANCE WITH INSTALLATION INSTRUCTIONS INCLUDED WITH THE PRODUCT. PREFABRICATED INSIDE/OUTSIDE CORNERS AND END CAPS ARE AVAILABLE TO COMPLETE THE INSTALLATION. SHOP FABRICATED COPINGS SHOULD BE INSTALLED IN ACCORDANCE WITH SMACNA GUIDELINES.
- PLEASE SEE BITUMINOUS FLASHING SPECIFICATIONS FOR A FULL DESCRIPTION OF INSTALLATION INSTRUCTIONS AND REQUIREMENTS WHICH ARE CONSIDERED A PART OF THIS DETAIL
- CAUTION: IMPROPER USE OF THESE MATERIALS AND APPLICATION EQUIPMENT CAN RESULT IN SEVERE BURNS, AND/ OR DAMAGE TO PROPERTY. THE MECHANIC MUST INSTALL THESE MATERIALS USING THE TECHNIQUES RECOMMENDED BY JM AND THOSE FOUND IN THE CERTIFIED ROOFING TORCH APPLICATOR (CERTA) PROGRAM AVAILABLE THROUGH THE NATIONAL ROOFING CONTRACTORS ASSOCIATION.

Johns Manville is a manufacturer of commercial roofing products and offers this general conceptual information to you as a courtesy. This complimentary assistance is not to be used or relied upon by anyone as a substitute for professional engineering design and documentation required by building code, contract, or applicable law. By accepting these comments you agree they do not constitute any representations, endorsements of, or an assumption by Johns Manville of any liability for either the adequacy of design of this building or any other material not supplied by Johns Manville.

Note: For the most current information on general guidelines, please refer to the System Considerations tab under Commercial Roofing Products on the JM Roofing Web site. For specifications, flashing details and general installation information please refer to the Application Tools tab.

Refer to the Safe Use Instructions and product label prior to using this product.



Base Flashing at Outside Corner

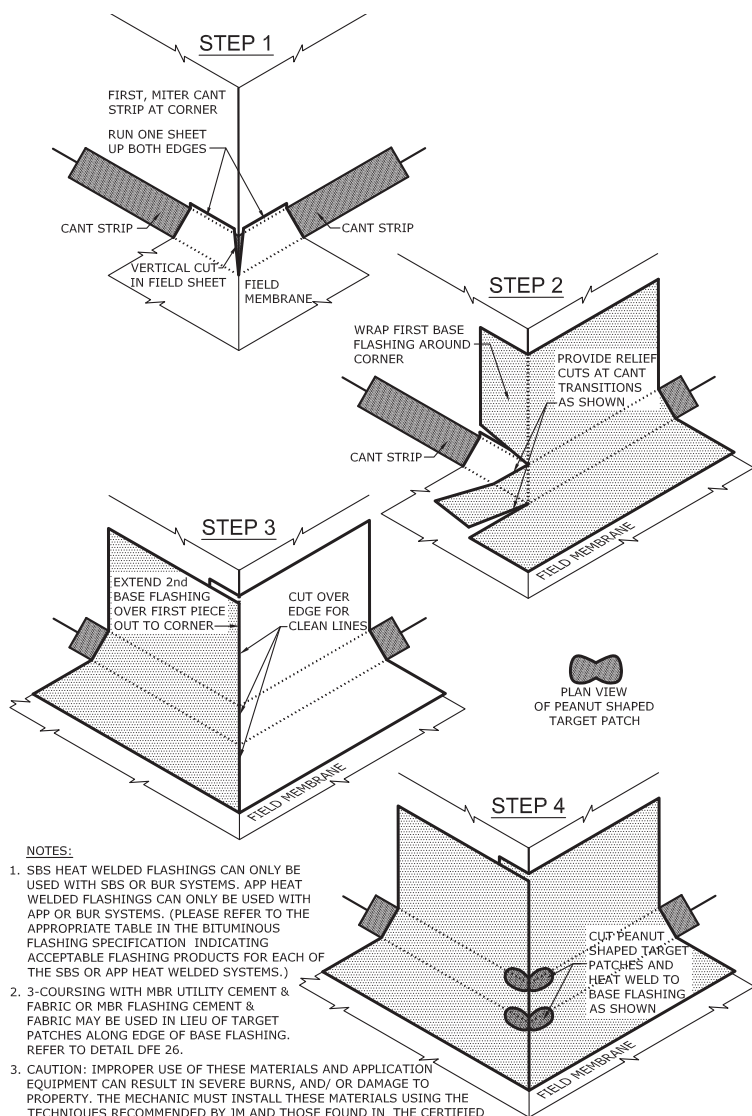

NOTES:

1. SBS HEAT WELDED FLASHINGS CAN ONLY BE USED WITH SBS OR BUR SYSTEMS. APP HEAT WELDED FLASHINGS CAN ONLY BE USED WITH APP OR BUR SYSTEMS. (PLEASE REFER TO THE APPROPRIATE TABLE IN THE BITUMINOUS FLASHING SPECIFICATION INDICATING ACCEPTABLE FLASHING PRODUCTS FOR EACH OF THE SBS OR APP HEAT WELDED SYSTEMS.)
2. 3-COURSUING WITH MBR UTILITY CEMENT & FABRIC OR MBR FLASHING CEMENT & FABRIC MAY BE USED IN LIEU OF TARGET PATCHES ALONG EDGE OF BASE FLASHING. REFER TO DETAIL DFE 26.
3. CAUTION: IMPROPER USE OF THESE MATERIALS AND APPLICATION EQUIPMENT CAN RESULT IN SEVERE BURNS, AND/ OR DAMAGE TO PROPERTY. THE MECHANIC MUST INSTALL THESE MATERIALS USING THE TECHNIQUES RECOMMENDED BY JM AND THOSE FOUND IN THE CERTIFIED ROOFING TORCH APPLICATOR (CERTA) PROGRAM AVAILABLE THROUGH THE NATIONAL ROOFING CONTRACTORS ASSOCIATION.
4. PLEASE SEE BITUMINOUS FLASHING SPECIFICATIONS FOR A FULL DESCRIPTION OF INSTALLATION INSTRUCTIONS AND REQUIREMENTS WHICH ARE CONSIDERED A PART OF THIS DETAIL.

Johns Manville is a manufacturer of commercial roofing products and offers this general conceptual information to you as a courtesy. This complimentary assistance is not to be used or relied upon by anyone as a substitute for professional engineering design and documentation required by building code, contract, or applicable law. By accepting these comments you agree they do not constitute any representations, endorsements of, or an assumption by Johns Manville of any liability for either the adequacy of design of this building or any other material not supplied by Johns Manville.

Note: For the most current information on general guidelines, please refer to the System Considerations tab under Commercial Roofing Products on the JM Roofing Web site. For specifications, flashing details and general installation information please refer to the Application Tools tab.

Refer to the Safe Use Instructions and product label prior to using this product.



Prefabricated Curb

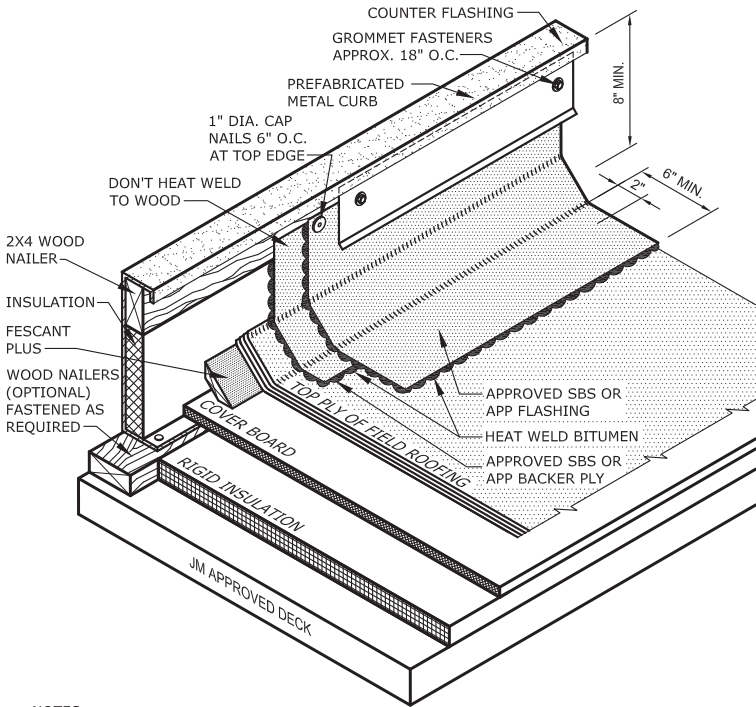

NOTES:

1. SBS HEAT WELDED FLASHINGS CAN ONLY BE USED WITH SBS OR BUR SYSTEMS. APP HEAT WELDED FLASHINGS CAN ONLY BE USED WITH APP OR BUR SYSTEMS. (PLEASE REFER TO THE APPROPRIATE TABLE IN THE BITUMINOUS FLASHING SPECIFICATION INDICATING ACCEPTABLE FLASHING PRODUCTS FOR EACH OF THE SBS OR APP HEAT WELDED SYSTEMS.)
2. CURB INSULATION MUST BE MECHANICALLY ATTACHED OR ADHERED SOLIDLY TO METAL CURB.
3. CURB MUST BE SET SO AS TO PROVIDE 8" MIN FLASHING HEIGHT.
4. METAL COUNTERFLASHING IS REQUIRED FOR ALL INSTALLATIONS.
5. HEIGHT OF CURB TO BE ADJUSTED WITH NAILERS. IT IS PREFERRED TO RAISE ROOF HATCH ONTO NAILERS TO EXTEND FLASHING HEIGHT.
6. VERTICAL JOINTS ARE TO BE OVERLAPPED 4" MINIMUM FOR ALL APPLICATIONS. 3 COURSING WITH MBR UTILITY CEMENT AND FABRIC OR JM MBR FLASHING CEMENT IS REQUIRED ON ALL VERTICAL FLASHING LAPS AND INSIDE/OUTSIDE CORNERS EXTENDING PAST LEADING EDGE OF CANT STRIP.
7. ANY CARPENTRY, METAL WORK, OR MASONRY CONSTRUCTION SHOULD BE DESIGNED AND CONSTRUCTED IN ACCORDANCE WITH LOCAL CODE REQUIREMENTS AND/OR PROJECT SPECIFICATIONS. THESE COMPONENTS SHOULD BE REVIEWED AND APPROVED BY A LICENSED DESIGN PROFESSIONAL.
8. PLEASE SEE BITUMINOUS FLASHING SPECIFICATIONS FOR A FULL DESCRIPTION OF INSTALLATION INSTRUCTIONS AND REQUIREMENTS WHICH ARE CONSIDERED A PART OF THIS DETAIL
9. CAUTION: IMPROPER USE OF THESE MATERIALS AND APPLICATION EQUIPMENT CAN RESULT IN SEVERE BURNS, AND/ OR DAMAGE TO PROPERTY. THE MECHANIC MUST INSTALL THESE MATERIALS USING THE TECHNIQUES RECOMMENDED BY JM AND THOSE FOUND IN THE CERTIFIED ROOFING TORCH APPLICATOR (CERTA) PROGRAM AVAILABLE THROUGH THE NATIONAL ROOFING CONTRACTORS ASSOCIATION.

Johns Manville is a manufacturer of commercial roofing products and offers this general conceptual information to you as a courtesy. This complimentary assistance is not to be used or relied upon by anyone as a substitute for professional engineering design and documentation required by building code, contract, or applicable law. By accepting these comments you agree they do not constitute any representations, endorsements of, or an assumption by Johns Manville of any liability for either the adequacy of design of this building or any other material not supplied by Johns Manville.

Note: For the most current information on general guidelines, please refer to the System Considerations tab under Commercial Roofing Products on the JM Roofing Web site. For specifications, flashing details and general installation information please refer to the Application Tools tab.

Refer to the Safe Use Instructions and product label prior to using this product.



JM Flex-I-Drain

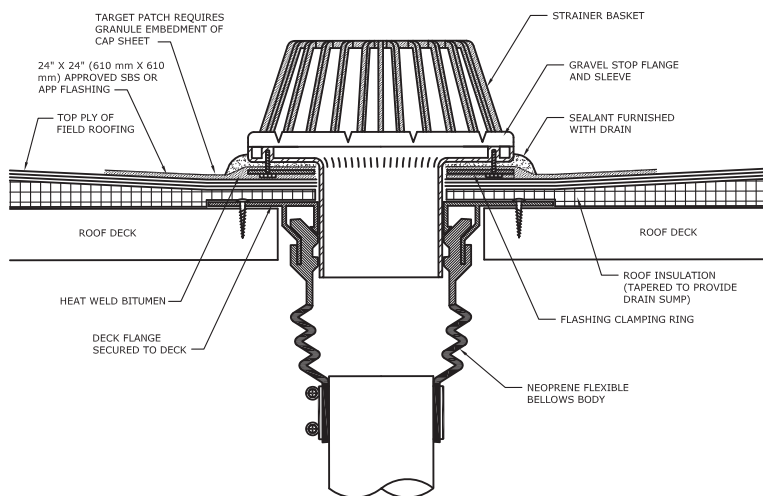

NOTES:

1. REFER TO JOHNS MANVILLE WEBSITE (www.jm.com) FOR MOST UP-TO-DATE INFORMATION.
2. SEE JM FLEX-I-DRAIN INSTALLATION INSTRUCTIONS FOR FURTHER INFORMATION.
3. ANY CARPENTRY, METAL WORK, OR MASONRY CONSTRUCTION SHOULD BE DESIGNED AND CONSTRUCTED IN ACCORDANCE WITH LOCAL CODE REQUIREMENTS AND/OR PROJECT SPECIFICATIONS. THESE COMPONENTS SHOULD BE REVIEWED AND APPROVED BY A LICENSED DESIGN PROFESSIONAL.
4. PLEASE SEE BITUMINOUS FLASHING SPECIFICATIONS FOR A FULL DESCRIPTION OF INSTALLATION INSTRUCTIONS AND REQUIREMENTS WHICH ARE CONSIDERED A PART OF THIS DETAIL.
7. SBS HEAT WELDED FLASHINGS CAN ONLY BE USED WITH SBS OR BUR SYSTEMS. APP HEAT WELDED FLASHINGS CAN ONLY BE USED WITH APP OR BUR SYSTEMS. (PLEASE REFER TO THE APPROPRIATE TABLE IN THE BITUMINOUS FLASHING SPECIFICATION INDICATING ACCEPTABLE FLASHING PRODUCTS FOR EACH OF THE SBS OR APP HEAT WELDED SYSTEMS.)
8. CAUTION: IMPROPER USE OF THESE MATERIALS AND APPLICATION EQUIPMENT CAN RESULT IN SEVERE BURNS, AND/ OR DAMAGE TO PROPERTY. THE MECHANIC MUST INSTALL THESE MATERIALS USING THE TECHNIQUES RECOMMENDED BY JM AND THOSE FOUND IN THE CERTIFIED ROOFING TORCH APPLICATOR (CERTA) PROGRAM AVAILABLE THROUGH THE NATIONAL ROOFING CONTRACTORS ASSOCIATION.

Johns Manville is a manufacturer of commercial roofing products and offers this general conceptual information to you as a courtesy. This complimentary assistance is not to be used or relied upon by anyone as a substitute for professional engineering design and documentation required by building code, contract, or applicable law. By accepting these comments you agree they do not constitute any representations, endorsements of, or an assumption by Johns Manville of any liability for either the adequacy of design of this building or any other material not supplied by Johns Manville.

Note: For the most current information on general guidelines, please refer to the System Considerations tab under Commercial Roofing Products on the JM Roofing Web site. For specifications, flashing details and general installation information please refer to the Application Tools tab.

Refer to the Safe Use Instructions and product label prior to using this product.



Metal Drain

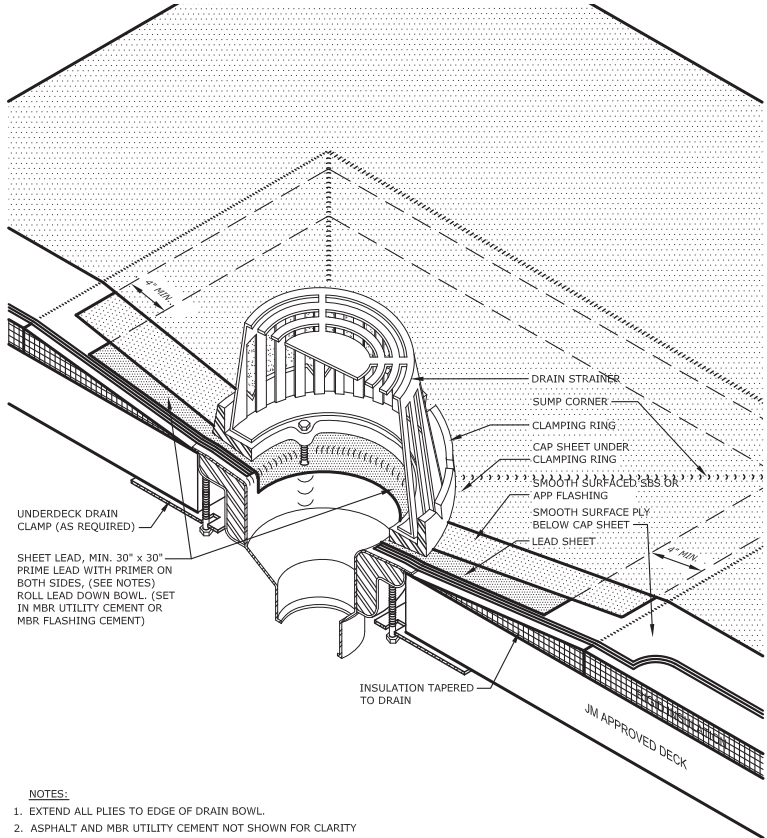

NOTES:

1. EXTEND ALL PLIES TO EDGE OF DRAIN BOWL.
2. ASPHALT AND MBR UTILITY CEMENT NOT SHOWN FOR CLARITY
3. LEAD FLASHING SHALL BE 2.5 LBS. PER SQUARE FOOT MINIMUM.
4. IT IS ACCEPTABLE TO RUN FIELD MEMBRANE PLY THROUGH DRAIN CENTER AND OMIT TARGET SHEET IF DRAIN SUMP IS SHALLOW ENOUGH TO ALLOW INSTALLATION WITHOUT WRINKLES OR FISHMOUTHS. STEEP SUMPS WILL REQUIRE THE INSTALLATION OF A TARGET PATCH WITHIN DRAIN SUMP.
5. USE ASPHALT PRIMER ON LEAD FLANGES WHEN USING MBR UTILITY CEMENT. USE PERMAFLASH PRIMER ON LEAD FLANGES WHEN USING MBR FLASHING CEMENT.
6. PLEASE SEE BITUMINOUS FLASHING SPECIFICATIONS FOR A FULL DESCRIPTION OF INSTALLATION INSTRUCTIONS AND REQUIREMENTS WHICH ARE CONSIDERED A PART OF THIS DETAIL
7. SBS HEAT WELDED FLASHINGS CAN ONLY BE USED WITH SBS OR BUR SYSTEMS. APP HEAT WELDED FLASHINGS CAN ONLY BE USED WITH APP OR BUR SYSTEMS. (PLEASE REFER TO THE APPROPRIATE TABLE IN THE BITUMINOUS FLASHING SPECIFICATION INDICATING ACCEPTABLE FLASHING PRODUCTS FOR EACH OF THE SBS OR APP HEAT WELDED SYSTEMS.)
8. CAUTION: IMPROPER USE OF THESE MATERIALS AND APPLICATION EQUIPMENT CAN RESULT IN SEVERE BURNS, AND/ OR DAMAGE TO PROPERTY. THE MECHANIC MUST INSTALL THESE MATERIALS USING THE TECHNIQUES RECOMMENDED BY JM AND THOSE FOUND IN THE CERTIFIED ROOFING TORCH APPLICATOR (CERTA) PROGRAM AVAILABLE THROUGH THE NATIONAL ROOFING CONTRACTORS ASSOCIATION.

Johns Manville is a manufacturer of commercial roofing products and offers this general conceptual information to you as a courtesy. This complimentary assistance is not to be used or relied upon by anyone as a substitute for professional engineering design and documentation required by building code, contract, or applicable law. By accepting these comments you agree they do not constitute any representations, endorsements of, or an assumption by Johns Manville of any liability for either the adequacy of design of this building or any other material not supplied by Johns Manville.

Note: For the most current information on general guidelines, please refer to the System Considerations tab under Commercial Roofing Products on the JM Roofing Web site. For specifications, flashing details and general installation information please refer to the Application Tools tab.

Refer to the Safe Use Instructions and product label prior to using this product.



Overflow Metal Scupper

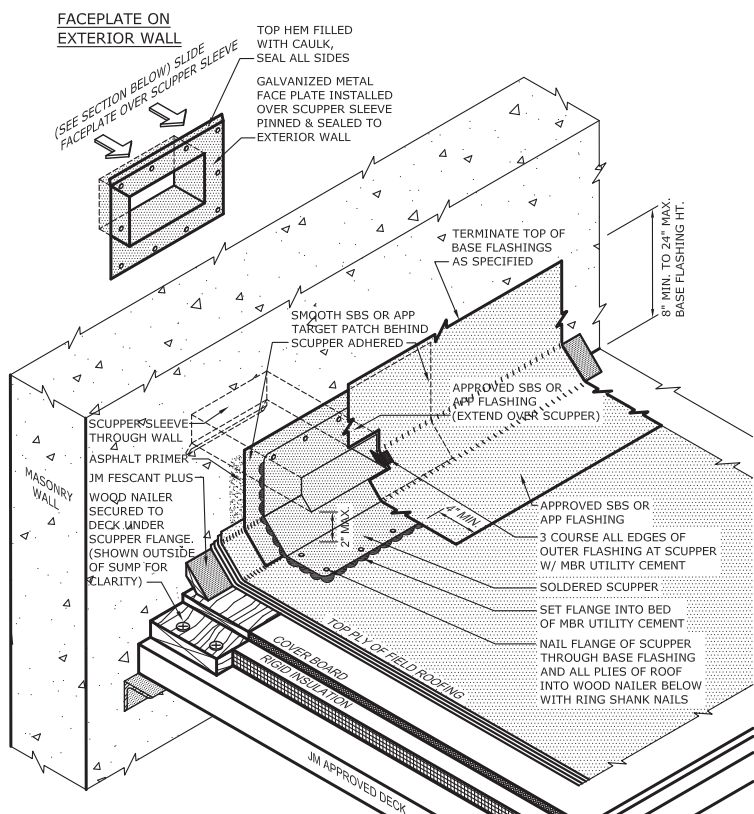

NOTES:

- ADHESIVE NOT SHOWN UNDER PLYS FOR CLARITY.
- SCUPPER FACEPLATE ON EXTERIOR SHOWN AS AN EXAMPLE.
- PRIME ALL SCUPPER FLANGES ON BOTH SIDES WITH ASPHALT PRIMER.
- ALL SCUPPER FLANGES SHALL BE 4" WIDE. PLEASE REFER TO LOCAL CODES AND SMACNA FOR METAL SCUPPER AND CONDUCTOR HEAD FABRICATION REQUIREMENTS.
- ANY CARPENTRY, METAL WORK, OR MASONRY CONSTRUCTION SHOULD BE DESIGNED AND CONSTRUCTED IN ACCORDANCE WITH LOCAL CODE REQUIREMENTS AND/OR PROJECT SPECIFICATIONS. THESE COMPONENTS SHOULD BE REVIEWED AND APPROVED BY A LICENSED DESIGN PROFESSIONAL.
- PLEASE SEE BITUMINOUS FLASHING SPECIFICATIONS FOR A FULL DESCRIPTION OF INSTALLATION INSTRUCTIONS AND REQUIREMENTS WHICH ARE CONSIDERED A PART OF THIS DETAIL.
- SBS HEAT WELDED FLASHINGS CAN ONLY BE USED WITH SBS OR BUR SYSTEMS. APP HEAT WELDED FLASHINGS CAN ONLY BE USED WITH APP OR BUR SYSTEMS. (PLEASE REFER TO THE APPROPRIATE TABLE IN THE BITUMINOUS FLASHING SPECIFICATION INDICATING ACCEPTABLE FLASHING PRODUCTS FOR EACH OF THE SBS OR APP HEAT WELDED SYSTEMS.)
- CAUTION: IMPROPER USE OF THESE MATERIALS AND APPLICATION EQUIPMENT CAN RESULT IN SEVERE BURNS, AND/OR DAMAGE TO PROPERTY. THE MECHANIC MUST INSTALL THESE MATERIALS USING THE TECHNIQUES RECOMMENDED BY JM AND THOSE FOUND IN THE CERTIFIED ROOFING TORCH APPLICATOR (CERTA) PROGRAM AVAILABLE THROUGH THE NATIONAL ROOFING CONTRACTORS ASSOCIATION.

Johns Manville is a manufacturer of commercial roofing products and offers this general conceptual information to you as a courtesy. This complimentary assistance is not to be used or relied upon by anyone as a substitute for professional engineering design and documentation required by building code, contract, or applicable law. By accepting these comments you agree they do not constitute any representations, endorsements of, or an assumption by Johns Manville of any liability for either the adequacy of design of this building or any other material not supplied by Johns Manville.

Note: For the most current information on general guidelines, please refer to the System Considerations tab under Commercial Roofing Products on the JM Roofing Web site. For specifications, flashing details and general installation information please refer to the Application Tools tab.

Refer to the Safe Use Instructions and product label prior to using this product.



Primary Metal Scupper in Sump

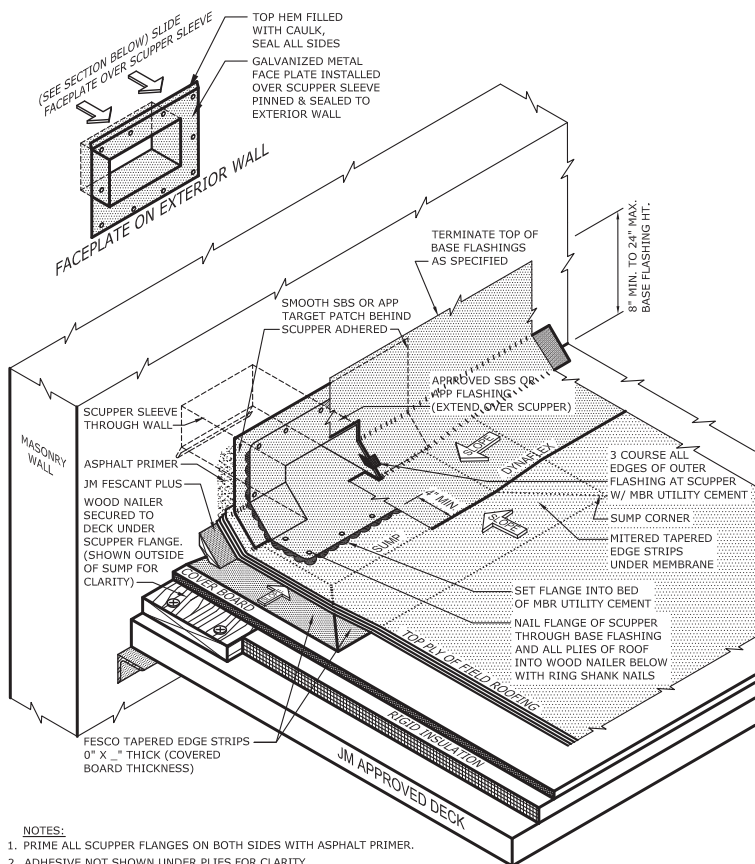

NOTES:

1. PRIME ALL SCUPPER FLANGES ON BOTH SIDES WITH ASPHALT PRIMER.
2. ADHESIVE NOT SHOWN UNDER PLYS FOR CLARITY.
3. SCUPPER FACEPLATE ON EXTERIOR SHOWN AS AN EXAMPLE.
4. ALL SCUPPER FLANGES SHALL BE 4" WIDE. PLEASE REFER TO LOCAL CODES AND SMACNA FOR METAL SCUPPER AND CONDUCTOR HEAD FABRICATION REQUIREMENTS.
5. ANY CARPENTRY, METAL WORK, OR MASONRY CONSTRUCTION SHOULD BE DESIGNED AND CONSTRUCTED IN ACCORDANCE WITH LOCAL CODE REQUIREMENTS AND/OR PROJECT SPECIFICATIONS. THESE COMPONENTS SHOULD BE REVIEWED AND APPROVED BY A LICENSED DESIGN PROFESSIONAL.
6. PLEASE SEE BITUMINOUS FLASHING SPECIFICATIONS FOR A FULL DESCRIPTION OF INSTALLATION INSTRUCTIONS AND REQUIREMENTS WHICH ARE CONSIDERED A PART OF THIS DETAIL.
7. SBS HEAT WELDED FLASHINGS CAN ONLY BE USED WITH SBS OR BUR SYSTEMS. APP HEAT WELDED FLASHINGS CAN ONLY BE USED WITH APP OR BUR SYSTEMS. (PLEASE REFER TO THE APPROPRIATE TABLE IN THE BITUMINOUS FLASHING SPECIFICATION INDICATING ACCEPTABLE FLASHING PRODUCTS FOR EACH OF THE SBS OR APP HEAT WELDED SYSTEMS.)
8. CAUTION: IMPROPER USE OF THESE MATERIALS AND APPLICATION EQUIPMENT CAN RESULT IN SEVERE BURNS, AND/OR DAMAGE TO PROPERTY. THE MECHANIC MUST INSTALL THESE MATERIALS USING THE TECHNIQUES RECOMMENDED BY JM AND THOSE FOUND IN THE CERTIFIED ROOFING TORCH APPLICATOR (CERTA) PROGRAM AVAILABLE THROUGH THE NATIONAL ROOFING CONTRACTORS ASSOCIATION.

Johns Manville is a manufacturer of commercial roofing products and offers this general conceptual information to you as a courtesy. This complimentary assistance is not to be used or relied upon by anyone as a substitute for professional engineering design and documentation required by building code, contract, or applicable law. By accepting these comments you agree they do not constitute any representations, endorsements of, or an assumption by Johns Manville of any liability for either the adequacy of design of this building or any other material not supplied by Johns Manville.

Note: For the most current information on general guidelines, please refer to the System Considerations tab under Commercial Roofing Products on the JM Roofing Web site. For specifications, flashing details and general installation information please refer to the Application Tools tab.

Refer to the Safe Use Instructions and product label prior to using this product.



Lightning Rod on Roof Surface

JM DOES NOT EVALUATE OR RECOMMEND ANY LIGHTNING PROTECTION MANUFACTURERS PRODUCTS. THE LIGHTNING PROTECTION DEVICES SHOWN ARE FOR GRAPHIC REPRESENTATION ONLY AND ARE NOT COVERED UNDER ANY JM GUARANTEE.

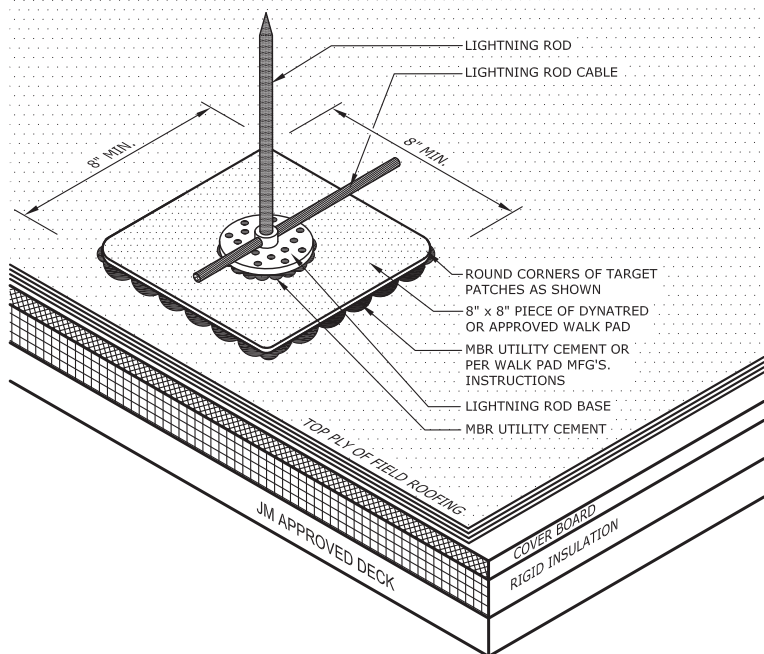

NOTES:

1. REFER TO JOHNS MANVILLE WEBSITE (www.jm.com) FOR MOST UP-TO-DATE INFORMATION.
2. ANY CARPENTRY, METAL WORK, OR MASONRY CONSTRUCTION SHOULD BE DESIGNED AND CONSTRUCTED IN ACCORDANCE WITH LOCAL CODE REQUIREMENTS AND/OR PROJECT SPECIFICATIONS. THESE COMPONENTS SHOULD BE REVIEWED AND APPROVED BY A LICENSED DESIGN PROFESSIONAL.
3. PLEASE SEE BITUMINOUS FLASHING SPECIFICATIONS FOR A FULL DESCRIPTION OF INSTALLATION INSTRUCTIONS AND REQUIREMENTS WHICH ARE CONSIDERED A PART OF THIS DETAIL.
4. LIGHTNING ROD GROUND WIRE MUST NOT COME IN CONTACT WITH THE ROOFING MATERIAL. A SACRIFICIAL LAYER OF MEMBRANE IS RECOMMENDED UNDER THE ENTIRE LENGTH OF GROUND WIRE(S).

Johns Manville is a manufacturer of commercial roofing products and offers this general conceptual information to you as a courtesy. This complimentary assistance is not to be used or relied upon by anyone as a substitute for professional engineering design and documentation required by building code, contract, or applicable law. By accepting these comments you agree they do not constitute any representations, endorsements of, or an assumption by Johns Manville of any liability for either the adequacy of design of this building or any other material not supplied by Johns Manville.

Note: For the most current information on general guidelines, please refer to the System Considerations tab under Commercial Roofing Products on the JM Roofing Web site. For specifications, flashing details and general installation information please refer to the Application Tools tab.

Refer to the Safe Use Instructions and product label prior to using this product.



Penetration Pocket

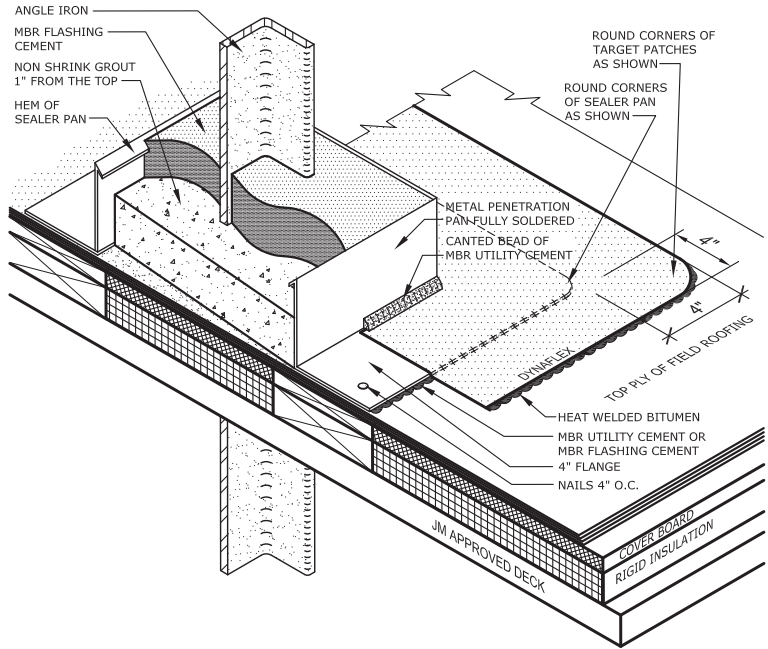

NOTES:

1. SBS HEAT WELDED FLASHINGS CAN ONLY BE USED WITH SBS OR BUR SYSTEMS. APP HEAT WELDED FLASHINGS CAN ONLY BE USED WITH APP OR BUR SYSTEMS. (PLEASE REFER TO THE APPROPRIATE TABLE IN THE BITUMINOUS FLASHING SPECIFICATION INDICATING ACCEPTABLE FLASHING PRODUCTS FOR EACH OF THE SBS OR APP HEAT WELDED SYSTEMS.)
2. MAINTAIN 2" MIN. CLEARANCE FROM PENETRATION TO EDGE OF METAL PAN.
3. ROUND FLANGE CORNERS ON METAL PAN.
4. PRIME INSIDE OF METAL PAN WITH PERMAFLASH PRIMER WHERE MBR FLASHING CEMENT WILL BE PLACED.
5. PENETRATION PANS ARE CONSIDERED MAINTENANCE ITEMS AND ARE NOT GUARANTEED BY JOHNS MANVILLE.
6. USE ASPHALT PRIMER ON FLANGES WHEN USING MBR UTILITY CEMENT. USE PERMAFLASH PRIMER ON FLANGES WHEN USING MBR FLASHING CEMENT.
7. ANY CARPENTRY, METAL WORK, OR MASONRY CONSTRUCTION SHOULD BE DESIGNED AND CONSTRUCTED IN ACCORDANCE WITH LOCAL CODE REQUIREMENTS AND/OR PROJECT SPECIFICATIONS. THESE COMPONENTS SHOULD BE REVIEWED AND APPROVED BY A LICENSED DESIGN PROFESSIONAL.
8. PLEASE SEE BITUMINOUS FLASHING SPECIFICATIONS FOR A FULL DESCRIPTION OF INSTALLATION INSTRUCTIONS AND REQUIREMENTS WHICH ARE CONSIDERED A PART OF THIS DETAIL
9. CAUTION: IMPROPER USE OF THESE MATERIALS AND APPLICATION EQUIPMENT CAN RESULT IN SEVERE BURNS, AND/OR DAMAGE TO PROPERTY. THE MECHANIC MUST INSTALL THESE MATERIALS USING THE TECHNIQUES RECOMMENDED BY JM AND THOSE FOUND IN THE CERTIFIED ROOFING TORCH APPLICATOR (CERTA) PROGRAM AVAILABLE THROUGH THE NATIONAL ROOFING CONTRACTORS ASSOCIATION.

Johns Manville is a manufacturer of commercial roofing products and offers this general conceptual information to you as a courtesy. This complimentary assistance is not to be used or relied upon by anyone as a substitute for professional engineering design and documentation required by building code, contract, or applicable law. By accepting these comments you agree they do not constitute any representations, endorsements of, or an assumption by Johns Manville of any liability for either the adequacy of design of this building or any other material not supplied by Johns Manville.

Note: For the most current information on general guidelines, please refer to the System Considerations tab under Commercial Roofing Products on the JM Roofing Web site. For specifications, flashing details and general installation information please refer to the Application Tools tab.

Refer to the Safe Use Instructions and product label prior to using this product.



FP-10 One Way® Roof Vent

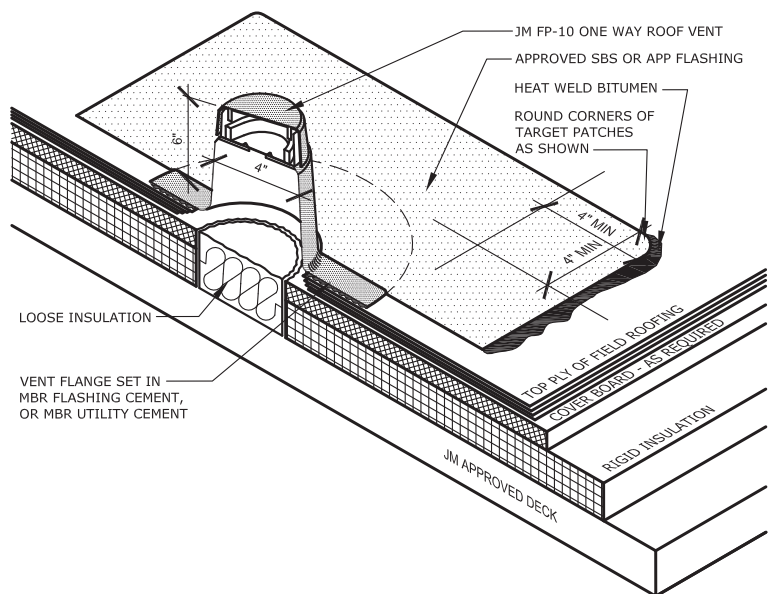

NOTES:

1. SBS HEAT WELDED FLASHINGS CAN ONLY BE USED WITH SBS OR BUR SYSTEMS. APP HEAT WELDED FLASHINGS CAN ONLY BE USED WITH APP OR BUR SYSTEMS. (PLEASE REFER TO THE APPROPRIATE TABLE IN THE BITUMINOUS FLASHING SPECIFICATION INDICATING ACCEPTABLE FLASHING PRODUCTS FOR EACH OF THE SBS OR APP HEAT WELDED SYSTEMS.)
2. CUT A 5" DIAMETER HOLE IN MEMBRANE PRIOR TO INSTALLATION. REMOVE ALL OR PART OF THE INSULATION TO FACILITATE VENTING. LOOSE INSULATION CAN REMAIN TO MAINTAIN R VALUE AND PREVENT CONDENSATION.
3. PLEASE SEE BITUMINOUS FLASHING SPECIFICATIONS FOR A FULL DESCRIPTION OF INSTALLATION INSTRUCTIONS AND REQUIREMENTS WHICH ARE CONSIDERED A PART OF THIS DETAIL.
4. CAUTION: IMPROPER USE OF THESE MATERIALS AND APPLICATION EQUIPMENT CAN RESULT IN SEVERE BURNS, AND/ OR DAMAGE TO PROPERTY. THE MECHANIC MUST INSTALL THESE MATERIALS USING THE TECHNIQUES RECOMMENDED BY JM AND THOSE FOUND IN THE CERTIFIED ROOFING TORCH APPLICATOR (CERTA) PROGRAM AVAILABLE THROUGH THE NATIONAL ROOFING CONTRACTORS ASSOCIATION.

Johns Manville is a manufacturer of commercial roofing products and offers this general conceptual information to you as a courtesy. This complimentary assistance is not to be used or relied upon by anyone as a substitute for professional engineering design and documentation required by building code, contract, or applicable law. By accepting these comments you agree they do not constitute any representations, endorsements of, or an assumption by Johns Manville of any liability for either the adequacy of design of this building or any other material not supplied by Johns Manville.

Note: For the most current information on general guidelines, please refer to the System Considerations tab under Commercial Roofing Products on the JM Roofing Web site. For specifications, flashing details and general installation information please refer to the Application Tools tab.

Refer to the Safe Use Instructions and product label prior to using this product.



Plumbing Vent

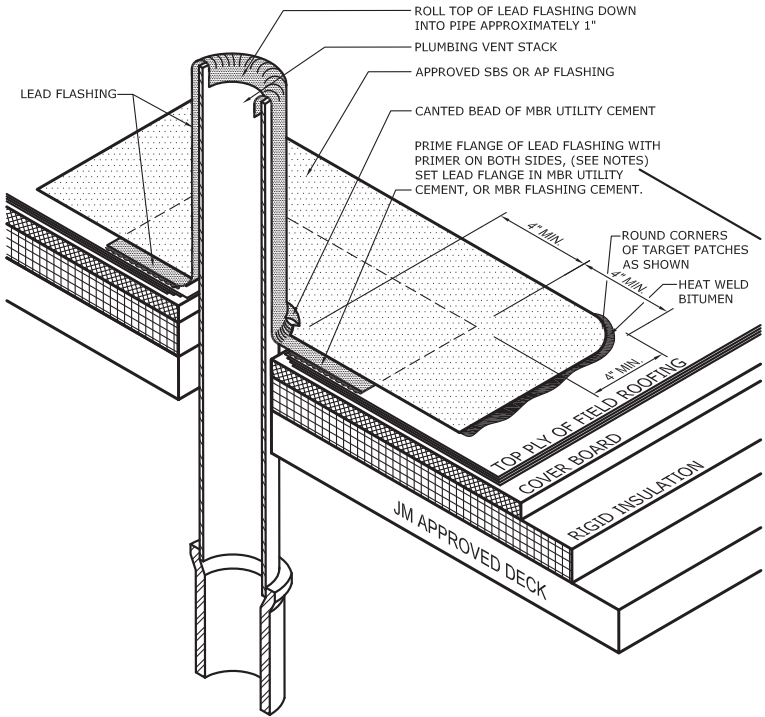

NOTES:

1. SBS HEAT WELDED FLASHINGS CAN ONLY BE USED WITH SBS OR BUR SYSTEMS. APP HEAT WELDED FLASHINGS CAN ONLY BE USED WITH APP OR BUR SYSTEMS. (PLEASE REFER TO THE APPROPRIATE TABLE IN THE BITUMINOUS FLASHING SPECIFICATION INDICATING ACCEPTABLE FLASHING PRODUCTS FOR EACH OF THE SBS OR APP HEAT WELDED SYSTEMS.)
2. LEAD FLASHING SHALL BE 2.5 LBS. PER SQUARE FOOT MINIMUM.
3. IF LEAD FLASHING IS NOT DESIRED OR PIPE IS TOO TALL, SEE PERMAFLASH DETAIL PMF-6 & PMF-6S FOR A SUITABLE ALTERNATIVE.
4. USE ASPHALT PRIMER ON LEAD FLANGES WHEN USING MBR UTILITY CEMENT. USE PERMAFLASH PRIMER ON LEAD FLANGES WHEN USING MBR FLASHING CEMENT.
5. PLEASE SEE BITUMINOUS FLASHING SPECIFICATIONS FOR A FULL DESCRIPTION OF INSTALLATION INSTRUCTIONS AND REQUIREMENTS WHICH ARE CONSIDERED A PART OF THIS DETAIL
6. CAUTION: IMPROPER USE OF THESE MATERIALS AND APPLICATION EQUIPMENT CAN RESULT IN SEVERE BURNS, AND/OR DAMAGE TO PROPERTY. THE MECHANIC MUST INSTALL THESE MATERIALS USING THE TECHNIQUES RECOMMENDED BY JM AND THOSE FOUND IN THE CERTIFIED ROOFING TORCH APPLICATOR (CERTA) PROGRAM AVAILABLE THROUGH THE NATIONAL ROOFING CONTRACTORS ASSOCIATION.

Johns Manville is a manufacturer of commercial roofing products and offers this general conceptual information to you as a courtesy. This complimentary assistance is not to be used or relied upon by anyone as a substitute for professional engineering design and documentation required by building code, contract, or applicable law. By accepting these comments you agree they do not constitute any representations, endorsements of, or an assumption by Johns Manville of any liability for either the adequacy of design of this building or any other material not supplied by Johns Manville.

Note: For the most current information on general guidelines, please refer to the System Considerations tab under Commercial Roofing Products on the JM Roofing Web site. For specifications, flashing details and general installation information please refer to the Application Tools tab.

Refer to the Safe Use Instructions and product label prior to using this product.



Base Flashing at Inside Corner

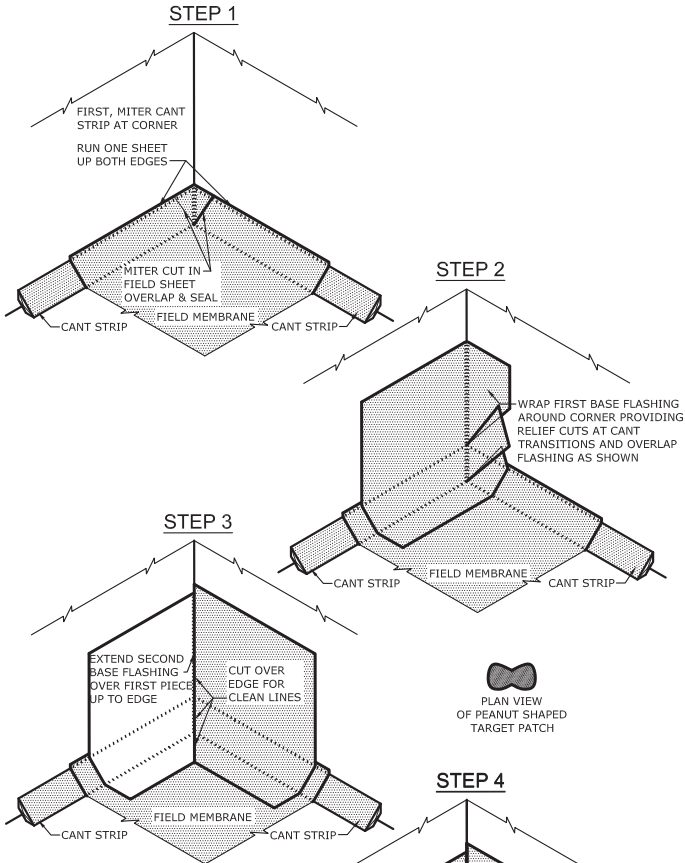

NOTES:

1. REFER TO JOHNS MANVILLE WEBSITE (www.jm.com) FOR MOST UP-TO-DATE INFORMATION.
2. SBS HEAT WELDED FLASHINGS CAN ONLY BE USED WITH SBS OR BUR SYSTEMS. APP HEAT WELDED FLASHINGS CAN ONLY BE USED WITH APP OR BUR SYSTEMS. (PLEASE REFER TO THE APPROPRIATE TABLE IN THE BITUMINOUS FLASHING SPECIFICATION INDICATING ACCEPTABLE FLASHING PRODUCTS FOR EACH OF THE SBS OR APP HEAT WELDED SYSTEMS.)
3. 3-COURSING WITH MBR UTILITY CEMENT & FABRIC OR MBR FLASHING CEMENT & FABRIC MAY BE USED IN LIEU OF TARGET PATCHES ALONG EDGE OF BASE FLASHING. REFER TO DETAIL DFE 26.
4. PLEASE SEE BITUMINOUS FLASHING SPECIFICATIONS FOR A FULL DESCRIPTION OF INSTALLATION INSTRUCTIONS AND REQUIREMENTS WHICH ARE CONSIDERED A PART OF THIS DETAIL.
5. CAUTION: IMPROPER USE OF THESE MATERIALS AND APPLICATION EQUIPMENT CAN RESULT IN SEVERE BURNS, AND/ OR DAMAGE TO PROPERTY. THE MECHANIC MUST INSTALL THESE MATERIALS USING THE TECHNIQUES RECOMMENDED BY JM AND THOSE FOUND IN THE CERTIFIED ROOFING TORCH APPLICATOR (CERTA) PROGRAM AVAILABLE THROUGH THE NATIONAL ROOFING CONTRACTORS ASSOCIATION.

Johns Manville is a manufacturer of commercial roofing products and offers this general conceptual information to you as a courtesy. This complimentary assistance is not to be used or relied upon by anyone as a substitute for professional engineering design and documentation required by building code, contract, or applicable law. By accepting these comments you agree they do not constitute any representations, endorsements of, or an assumption by Johns Manville of any liability for either the adequacy of design of this building or any other material not supplied by Johns Manville.

Note: For the most current information on general guidelines, please refer to the System Considerations tab under Commercial Roofing Products on the JM Roofing Web site. For specifications, flashing details and general installation information please refer to the Application Tools tab.

Refer to the Safe Use Instructions and product label prior to using this product.



EPDM Wall Covering with Bituminous Base Flashing

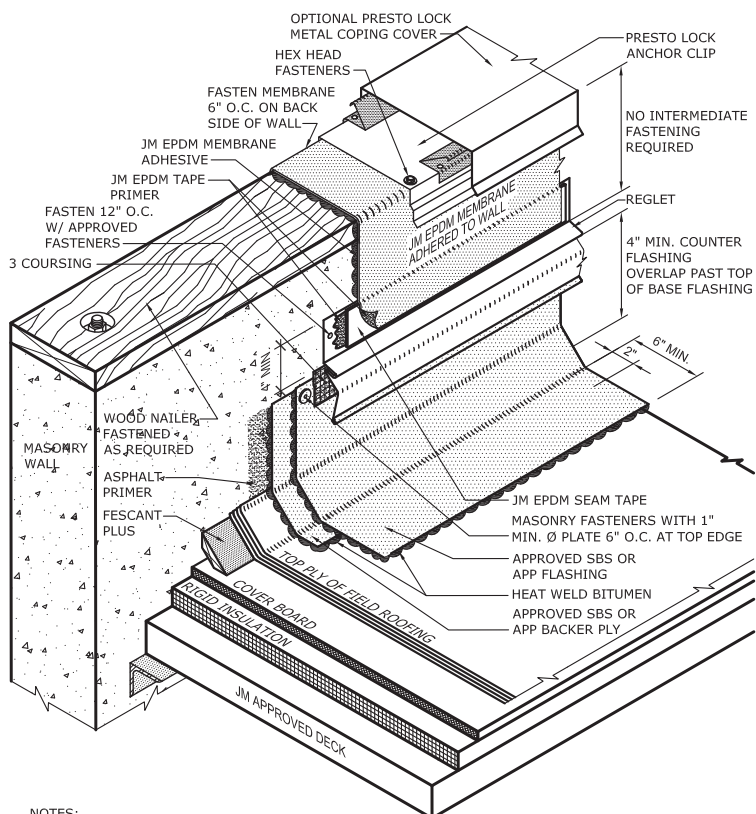

NOTES:

- SBS HEAT WELDED FLASHINGS CAN ONLY BE USED WITH SBS OR BUR SYSTEMS. APP HEAT WELDED FLASHINGS CAN ONLY BE USED WITH APP OR BUR SYSTEMS. (PLEASE REFER TO THE APPROPRIATE TABLE IN THE BITUMINOUS FLASHING SPECIFICATION INDICATING ACCEPTABLE FLASHING PRODUCTS FOR EACH OF THE SBS OR APP HEAT WELDED SYSTEMS.)
- VERTICAL JOINTS ARE TO BE OVERLAPPED 4" MINIMUM FOR ALL APPLICATIONS. 3 COURSING WITH MBR UTILITY CEMENT AND FABRIC OR JM MBR FLASHING CEMENT IS REQUIRED ON ALL VERTICAL FLASHING LAPS AND INSIDE/OUTSIDE CORNERS EXTENDING PAST LEADING EDGE OF CANT STRIP.
- ANY CARPENTRY, METAL WORK, OR MASONRY CONSTRUCTION SHOULD BE DESIGNED AND CONSTRUCTED IN ACCORDANCE WITH LOCAL CODE REQUIREMENTS AND/OR PROJECT SPECIFICATIONS. THESE COMPONENTS SHOULD BE REVIEWED AND APPROVED BY A LICENSED DESIGN PROFESSIONAL.
- INSTALL PRESTO LOCK COPING IN ACCORDANCE WITH INSTALLATION INSTRUCTIONS INCLUDED WITH THE PRODUCT. PREFABRICATED INSIDE/OUTSIDE CORNERS AND END CAPS ARE AVAILABLE TO COMPLETE THE INSTALLATION. SHOP FABRICATED COPINGS SHOULD BE INSTALLED IN ACCORDANCE WITH SMACNA GUIDELINES.
- PLEASE SEE BITUMINOUS FLASHING SPECIFICATIONS FOR A FULL DESCRIPTION OF INSTALLATION INSTRUCTIONS AND REQUIREMENTS WHICH ARE CONSIDERED A PART OF THIS DETAIL
- A TERMINATION BAR FASTENED 6" O.C. IS AN ACCEPTABLE SECUREMENT ALTERNATIVE ALONG THE TOP EDGE OF THE FLASHING.
- CAUTION: IMPROPER USE OF THESE MATERIALS AND APPLICATION EQUIPMENT CAN RESULT IN SEVERE BURNS, AND/OR DAMAGE TO PROPERTY. THE MECHANIC MUST INSTALL THESE MATERIALS USING THE TECHNIQUES RECOMMENDED BY JM AND THOSE FOUND IN THE CERTIFIED ROOFING TORCH APPLICATOR (CERTA) PROGRAM AVAILABLE THROUGH THE NATIONAL ROOFING CONTRACTORS ASSOCIATION.

Johns Manville is a manufacturer of commercial roofing products and offers this general conceptual information to you as a courtesy. This complimentary assistance is not to be used or relied upon by anyone as a substitute for professional engineering design and documentation required by building code, contract, or applicable law. By accepting these comments you agree they do not constitute any representations, endorsements of, or an assumption by Johns Manville of any liability for either the adequacy of design of this building or any other material not supplied by Johns Manville.

Note: For the most current information on general guidelines, please refer to the System Considerations tab under Commercial Roofing Products on the JM Roofing Web site. For specifications, flashing details and general installation information please refer to the Application Tools tab.

Refer to the Safe Use Instructions and product label prior to using this product.



Gypsum Wall on Metal Studs >24" w/ Coping

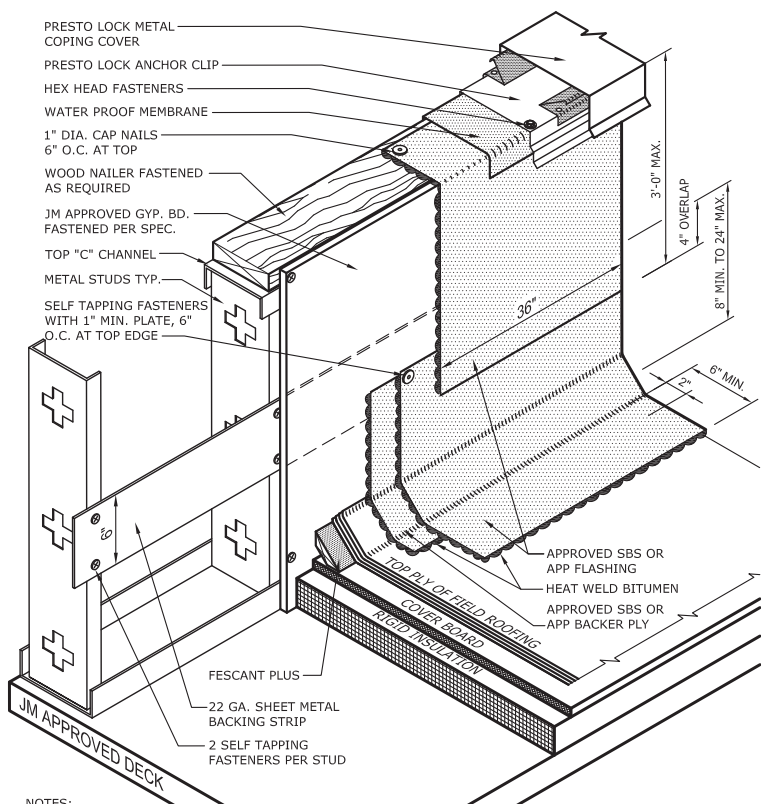

NOTES:

1. SBS HEAT WELDED FLASHINGS CAN ONLY BE USED WITH SBS OR BUR SYSTEMS. APP HEAT WELDED FLASHINGS CAN ONLY BE USED WITH APP OR BUR SYSTEMS. (PLEASE REFER TO THE APPROPRIATE TABLE IN THE BITUMINOUS FLASHING SPECIFICATION INDICATING ACCEPTABLE FLASHING PRODUCTS FOR EACH OF THE SBS OR APP HEAT WELDED SYSTEMS.)
2. VERTICAL JOINTS ARE TO BE OVERLAPPED 4" MINIMUM FOR ALL APPLICATIONS. 3 COURSING WITH MBR UTILITY CEMENT AND FABRIC OR JM MBR FLASHING CEMENT IS REQUIRED ON ALL VERTICAL FLASHING LAPS AND INSIDE/OUTSIDE CORNERS EXTENDING PAST LEADING EDGE OF CANT STRIP.
3. ANY CARPENTRY, METAL WORK, OR MASONRY CONSTRUCTION SHOULD BE DESIGNED AND CONSTRUCTED IN ACCORDANCE WITH LOCAL CODE REQUIREMENTS AND/OR PROJECT SPECIFICATIONS. THESE COMPONENTS SHOULD BE REVIEWED AND APPROVED BY A LICENSED DESIGN PROFESSIONAL.
4. INSTALL PRESTO LOCK COPING IN ACCORDANCE WITH INSTALLATION INSTRUCTIONS INCLUDED WITH THE PRODUCT. PREFABRICATED INSIDE/OUTSIDE CORNERS AND END CAPS ARE AVAILABLE TO COMPLETE THE INSTALLATION. SHOP FABRICATED COPINGS SHOULD BE INSTALLED IN ACCORDANCE WITH SMACNA GUIDELINES.
5. PLEASE SEE BITUMINOUS FLASHING SPECIFICATIONS FOR A FULL DESCRIPTION OF INSTALLATION INSTRUCTIONS AND REQUIREMENTS WHICH ARE CONSIDERED A PART OF THIS DETAIL
6. CAUTION: IMPROPER USE OF THESE MATERIALS AND APPLICATION EQUIPMENT CAN RESULT IN SEVERE BURNS, AND/OR DAMAGE TO PROPERTY. THE MECHANIC MUST INSTALL THESE MATERIALS USING THE TECHNIQUES RECOMMENDED BY JM AND THOSE FOUND IN THE CERTIFIED ROOFING TORCH APPLICATOR (CERTA) PROGRAM AVAILABLE THROUGH THE NATIONAL ROOFING CONTRACTORS ASSOCIATION.

Johns Manville is a manufacturer of commercial roofing products and offers this general conceptual information to you as a courtesy. This complimentary assistance is not to be used or relied upon by anyone as a substitute for professional engineering design and documentation required by building code, contract, or applicable law. By accepting these comments you agree they do not constitute any representations, endorsements of, or an assumption by Johns Manville of any liability for either the adequacy of design of this building or any other material not supplied by Johns Manville.

Note: For the most current information on general guidelines, please refer to the System Considerations tab under Commercial Roofing Products on the JM Roofing Web site. For specifications, flashing details and general installation information please refer to the Application Tools tab.

Refer to the Safe Use Instructions and product label prior to using this product.



Gypsum Wall on Metal Studs <24" w/ Coping

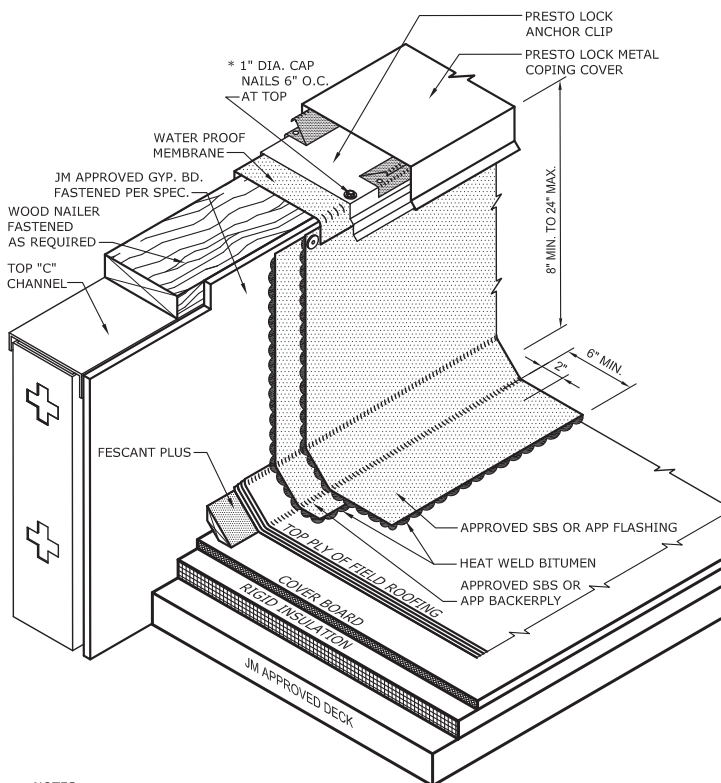

NOTES:

1. SBS HEAT WELDED FLASHINGS CAN ONLY BE USED WITH SBS OR BUR SYSTEMS. APP HEAT WELDED FLASHINGS CAN ONLY BE USED WITH APP OR BUR SYSTEMS. (PLEASE REFER TO THE APPROPRIATE TABLE IN THE BITUMINOUS FLASHING SPECIFICATION INDICATING ACCEPTABLE FLASHING PRODUCTS FOR EACH OF THE SBS OR APP HEAT WELDED SYSTEMS.)
2. VERTICAL JOINTS ARE TO BE OVERLAPPED 4" MINIMUM FOR ALL APPLICATIONS. 3 COURSING WITH MBR UTILITY CEMENT AND FABRIC OR JM MBR FLASHING CEMENT IS REQUIRED ON ALL VERTICAL FLASHING LAPS AND INSIDE/OUTSIDE CORNERS EXTENDING PAST LEADING EDGE OF CANT STRIP.
3. ANY CARPENTRY, METAL WORK, OR MASONRY CONSTRUCTION SHOULD BE DESIGNED AND CONSTRUCTED IN ACCORDANCE WITH LOCAL CODE REQUIREMENTS AND/OR PROJECT SPECIFICATIONS. THESE COMPONENTS SHOULD BE REVIEWED AND APPROVED BY A LICENSED DESIGN PROFESSIONAL.
4. INSTALL PRESTO LOCK COPING IN ACCORDANCE WITH INSTALLATION INSTRUCTIONS INCLUDED WITH THE PRODUCT. PREFABRICATED INSIDE/OUTSIDE CORNERS AND END CAPS ARE AVAILABLE TO COMPLETE THE INSTALLATION. SHOP FABRICATED COPINGS SHOULD BE INSTALLED IN ACCORDANCE WITH SMACNA GUIDELINES.
5. PLEASE SEE BITUMINOUS FLASHING SPECIFICATIONS FOR A FULL DESCRIPTION OF INSTALLATION INSTRUCTIONS AND REQUIREMENTS WHICH ARE CONSIDERED A PART OF THIS DETAIL
6. *A TERMINATION BAR FASTENED 6" O.C. IS AN ACCEPTABLE SECUREMENT ALTERNATIVE ALONG THE TOP EDGE OF FLASHING.
7. CAUTION: IMPROPER USE OF THESE MATERIALS AND APPLICATION EQUIPMENT CAN RESULT IN SEVERE BURNS, AND/ OR DAMAGE TO PROPERTY. THE MECHANIC MUST INSTALL THESE MATERIALS USING THE TECHNIQUES RECOMMENDED BY JM AND THOSE FOUND IN THE CERTIFIED ROOFING TORCH APPLICATOR (CERTA) PROGRAM AVAILABLE THROUGH THE NATIONAL ROOFING CONTRACTORS ASSOCIATION.

Johns Manville is a manufacturer of commercial roofing products and offers this general conceptual information to you as a courtesy. This complimentary assistance is not to be used or relied upon by anyone as a substitute for professional engineering design and documentation required by building code, contract, or applicable law. By accepting these comments you agree they do not constitute any representations, endorsements of, or an assumption by Johns Manville of any liability for either the adequacy of design of this building or any other material not supplied by Johns Manville.

Note: For the most current information on general guidelines, please refer to the System Considerations tab under Commercial Roofing Products on the JM Roofing Web site. For specifications, flashing details and general installation information please refer to the Application Tools tab.

Refer to the Safe Use Instructions and product label prior to using this product.



Masonry Wall >24" with Coping

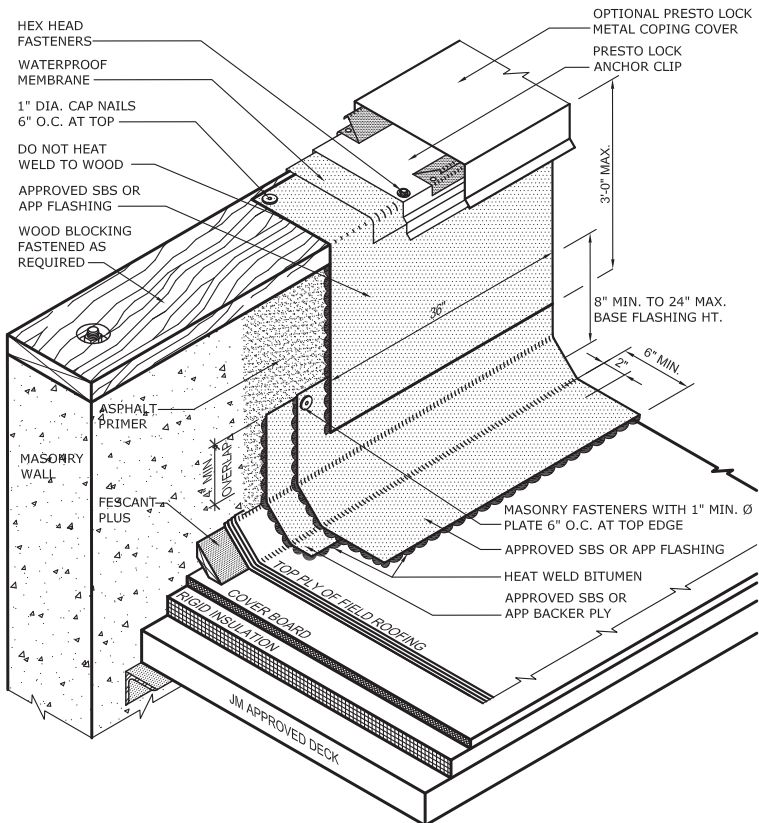

NOTES:

1. SBS HEAT WELDED FLASHINGS CAN ONLY BE USED WITH SBS OR BUR SYSTEMS. APP HEAT WELDED FLASHINGS CAN ONLY BE USED WITH APP OR BUR SYSTEMS. (PLEASE REFER TO THE APPROPRIATE TABLE IN THE BITUMINOUS FLASHING SPECIFICATION INDICATING ACCEPTABLE FLASHING PRODUCTS FOR EACH OF THE SBS OR APP HEAT WELDED SYSTEMS.)
2. VERTICAL JOINTS ARE TO BE OVERLAPPED 4" MINIMUM FOR ALL APPLICATIONS. 3 COURSING WITH MBR UTILITY CEMENT AND FABRIC OR JM MBR FLASHING CEMENT IS REQUIRED ON ALL VERTICAL FLASHING LAPS AND INSIDE/OUTSIDE CORNERS EXTENDING PAST LEADING EDGE OF CANT STRIP.
3. INSTALL PRESTO LOCK COPING IN ACCORDANCE WITH INSTALLATION INSTRUCTIONS INCLUDED WITH THE PRODUCT. PREFABRICATED INSIDE/OUTSIDE CORNERS AND END CAPS ARE AVAILABLE TO COMPLETE THE INSTALLATION. SHOP FABRICATED COPINGS SHOULD BE INSTALLED IN ACCORDANCE WITH SMACNA GUIDELINES.
4. ANY CARPENTRY, METAL WORK, OR MASONRY CONSTRUCTION SHOULD BE DESIGNED AND CONSTRUCTED IN ACCORDANCE WITH LOCAL CODE REQUIREMENTS AND/OR PROJECT SPECIFICATIONS. THESE COMPONENTS SHOULD BE REVIEWED AND APPROVED BY A LICENSED DESIGN PROFESSIONAL.
5. PLEASE SEE BITUMINOUS FLASHING SPECIFICATIONS FOR A FULL DESCRIPTION OF INSTALLATION INSTRUCTIONS AND REQUIREMENTS WHICH ARE CONSIDERED A PART OF THIS DETAIL
6. CAUTION: IMPROPER USE OF THESE MATERIALS AND APPLICATION EQUIPMENT CAN RESULT IN SEVERE BURNS, AND/ OR DAMAGE TO PROPERTY. THE MECHANIC MUST INSTALL THESE MATERIALS USING THE TECHNIQUES RECOMMENDED BY JM AND THOSE FOUND IN THE CERTIFIED ROOFING TORCH APPLICATOR (CERTA) PROGRAM AVAILABLE THROUGH THE NATIONAL ROOFING CONTRACTORS ASSOCIATION.

Johns Manville is a manufacturer of commercial roofing products and offers this general conceptual information to you as a courtesy. This complimentary assistance is not to be used or relied upon by anyone as a substitute for professional engineering design and documentation required by building code, contract, or applicable law. By accepting these comments you agree they do not constitute any representations, endorsements of, or an assumption by Johns Manville of any liability for either the adequacy of design of this building or any other material not supplied by Johns Manville.

Note: For the most current information on general guidelines, please refer to the System Considerations tab under Commercial Roofing Products on the JM Roofing Web site. For specifications, flashing details and general installation information please refer to the Application Tools tab.

Refer to the Safe Use Instructions and product label prior to using this product.



Masonry Wall <24" with Coping

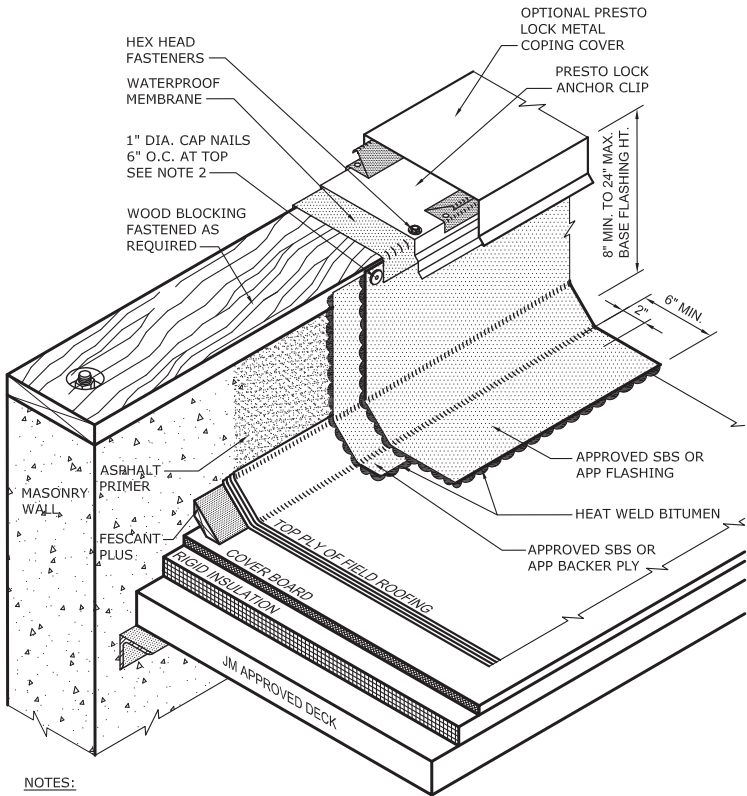

NOTES:

1. SBS HEAT WELDED FLASHINGS CAN ONLY BE USED WITH SBS OR BUR SYSTEMS. APP HEAT WELDED FLASHINGS CAN ONLY BE USED WITH APP OR BUR SYSTEMS. (PLEASE REFER TO THE APPROPRIATE TABLE IN THE BITUMINOUS FLASHING SPECIFICATION INDICATING ACCEPTABLE FLASHING PRODUCTS FOR EACH OF THE SBS OR APP HEAT WELDED SYSTEMS.)
- 2.*A TERMINATION BAR FASTENED 6" O.C. IS AN ACCEPTABLE SECUREMENT ALTERNATIVE ALONG THE TOP EDGE OF THE FLASHING.
3. VERTICAL JOINTS ARE TO BE OVERLAPPED 4" MINIMUM FOR ALL APPLICATIONS. 3 COURSING WITH MBR UTILITY CEMENT AND FABRIC OR JM MBR FLASHING CEMENT IS REQUIRED ON ALL VERTICAL FLASHING LAPS AND INSIDE/OUTSIDE CORNERS EXTENDING PAST LEADING EDGE OF CANT STRIP.
4. ANY CARPENTRY, METAL WORK, OR MASONRY CONSTRUCTION SHOULD BE DESIGNED AND CONSTRUCTED IN ACCORDANCE WITH LOCAL CODE REQUIREMENTS AND/OR PROJECT SPECIFICATIONS. THESE COMPONENTS SHOULD BE REVIEWED AND APPROVED BY A LICENSED DESIGN PROFESSIONAL.
5. INSTALL PRESTO LOCK COPING IN ACCORDANCE WITH INSTALLATION INSTRUCTIONS INCLUDED WITH THE PRODUCT. PREFABRICATED INSIDE/OUTSIDE CORNERS AND END CAPS ARE AVAILABLE TO COMPLETE THE INSTALLATION. SHOP FABRICATED COPINGS SHOULD BE INSTALLED IN ACCORDANCE WITH SMACNA GUIDELINES.
6. PLEASE SEE BITUMINOUS FLASHING SPECIFICATIONS FOR A FULL DESCRIPTION OF INSTALLATION INSTRUCTIONS AND REQUIREMENTS WHICH ARE CONSIDERED A PART OF THIS DETAIL
7. CAUTION: IMPROPER USE OF THESE MATERIALS AND APPLICATION EQUIPMENT CAN RESULT IN SEVERE BURNS, AND/ OR DAMAGE TO PROPERTY. THE MECHANIC MUST INSTALL THESE MATERIALS USING THE TECHNIQUES RECOMMENDED BY JM AND THOSE FOUND IN THE CERTIFIED ROOFING TORCH APPLICATOR (CERTA) PROGRAM AVAILABLE THROUGH THE NATIONAL ROOFING CONTRACTORS

Johns Manville is a manufacturer of commercial roofing products and offers this general conceptual information to you as a courtesy. This complimentary assistance is not to be used or relied upon by anyone as a substitute for professional engineering design and documentation required by building code, contract, or applicable law. By accepting these comments you agree they do not constitute any representations, endorsements of, or an assumption by Johns Manville of any liability for either the adequacy of design of this building or any other material not supplied by Johns Manville.

Note: For the most current information on general guidelines, please refer to the System Considerations tab under Commercial Roofing Products on the JM Roofing Web site. For specifications, flashing details and general installation information please refer to the Application Tools tab.

Refer to the Safe Use Instructions and product label prior to using this product.



Masonry Wall w/ Counterflashing

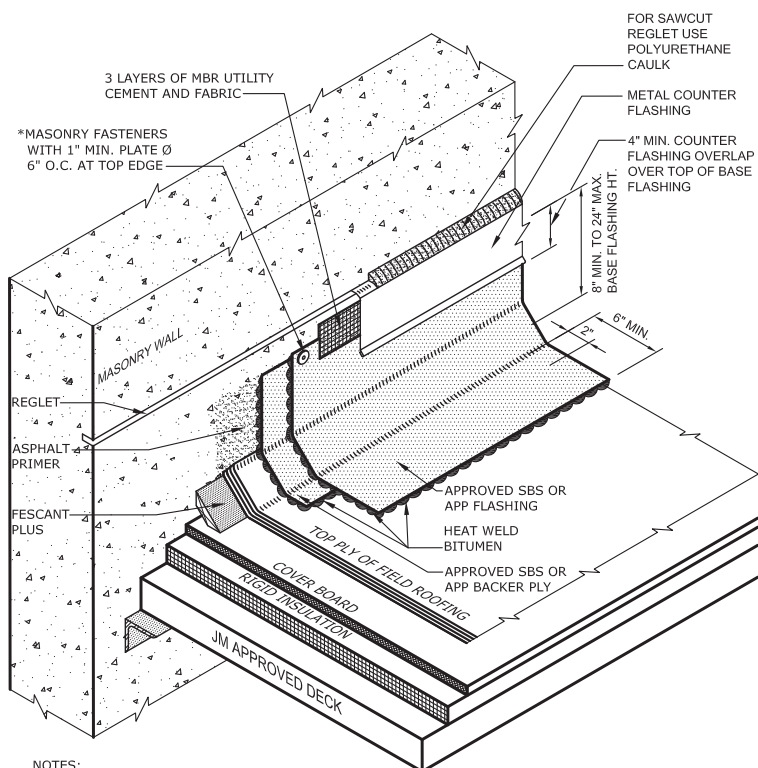

NOTES:

1. SBS HEAT WELDED FLASHINGS CAN ONLY BE USED WITH SBS OR BUR SYSTEMS. APP HEAT WELDED FLASHINGS CAN ONLY BE USED WITH APP OR BUR SYSTEMS. (PLEASE REFER TO THE APPROPRIATE TABLE IN THE BITUMINOUS FLASHING SPECIFICATION INDICATING ACCEPTABLE FLASHING PRODUCTS FOR EACH OF THE SBS OR APP HEAT WELDED SYSTEMS.)
2. *A TERMINATION BAR FASTENED 6" O.C. IS AN ACCEPTABLE SECUREMENT ALTERNATIVE ALONG THE TOP EDGE OF THE FLASHING.
3. METAL COUNTER FLASHING IS RECOMMENDED FOR ALL INSTALLATIONS AND IS REQUIRED FOR ALL GUARANTEES 15 YEARS OR LONGER. A 3 COURSING OF PERMAFLASH MAY BE USED TO SEAL THE TOP EDGE OF THE FLASHING ON 10 YEAR NDL'S IN LIEU OF METAL COUNTER FLASHING.
4. VERTICAL JOINTS ARE TO BE OVERLAPPED 4" MINIMUM FOR ALL APPLICATIONS. 3 COURSING WITH MBR UTILITY CEMENT AND FABRIC OR JM MBR FLASHING CEMENT IS REQUIRED ON ALL VERTICAL FLASHING LAPS AND INSIDE/OUTSIDE CORNERS EXTENDING PAST LEADING EDGE OF CANT STRIP.
5. ANY CARPENTRY, METAL WORK, OR MASONRY CONSTRUCTION SHOULD BE DESIGNED AND CONSTRUCTED IN ACCORDANCE WITH LOCAL CODE REQUIREMENTS AND/OR PROJECT SPECIFICATIONS. THESE COMPONENTS SHOULD BE REVIEWED AND APPROVED BY A LICENSED DESIGN PROFESSIONAL.
6. PLEASE SEE BITUMINOUS FLASHING SPECIFICATIONS FOR A FULL DESCRIPTION OF INSTALLATION INSTRUCTIONS AND REQUIREMENTS WHICH ARE CONSIDERED A PART OF THIS DETAIL
7. CAUTION: IMPROPER USE OF THESE MATERIALS AND APPLICATION EQUIPMENT CAN RESULT IN SEVERE BURNS, AND/ OR DAMAGE TO PROPERTY. THE MECHANIC MUST INSTALL THESE MATERIALS USING THE TECHNIQUES RECOMMENDED BY JM AND THOSE FOUND IN THE CERTIFIED ROOFING TORCH APPLICATOR (CERTA) PROGRAM AVAILABLE THROUGH THE NATIONAL ROOFING CONTRACTORS ASSOCIATION.

Johns Manville is a manufacturer of commercial roofing products and offers this general conceptual information to you as a courtesy. This complimentary assistance is not to be used or relied upon by anyone as a substitute for professional engineering design and documentation required by building code, contract, or applicable law. By accepting these comments you agree they do not constitute any representations, endorsements of, or an assumption by Johns Manville of any liability for either the adequacy of design of this building or any other material not supplied by Johns Manville.

Note: For the most current information on general guidelines, please refer to the System Considerations tab under Commercial Roofing Products on the JM Roofing Web site. For specifications, flashing details and general installation information please refer to the Application Tools tab.

Refer to the Safe Use Instructions and product label prior to using this product.



Optional Two-Ply Base Flashing for Load-Bearing Masonry Wall w/ Counterflashing

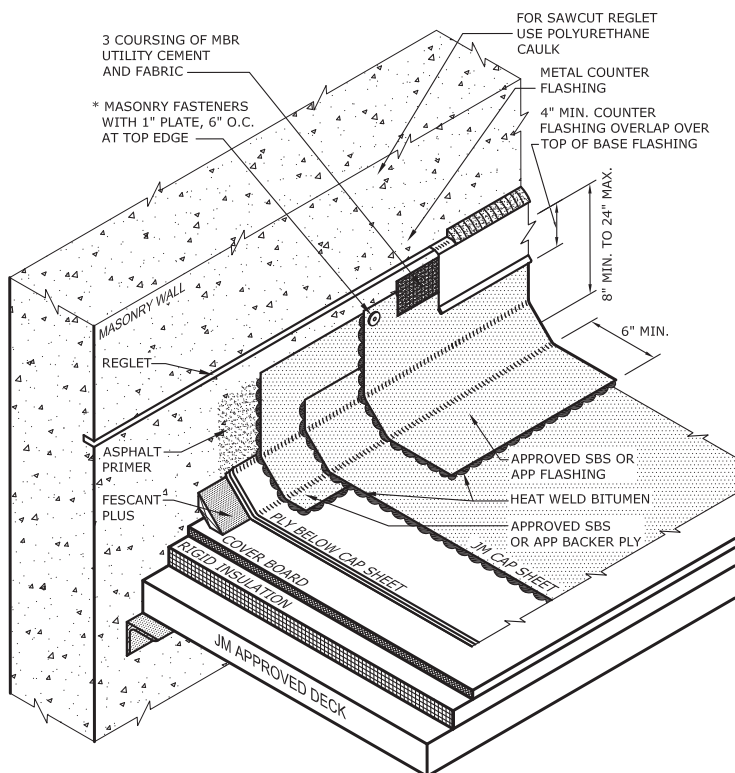

NOTES:

1. SBS HEAT WELDED FLASHINGS CAN ONLY BE USED WITH SBS OR BUR SYSTEMS. APP HEAT WELDED FLASHINGS CAN ONLY BE USED WITH APP OR BUR SYSTEMS. (PLEASE REFER TO THE APPROPRIATE TABLE IN THE BITUMINOUS FLASHING SPECIFICATION INDICATING ACCEPTABLE FLASHING PRODUCTS FOR EACH OF THE SBS OR APP HEAT WELDED SYSTEMS.)
2. EXTEND SMOOTH SURFACED SBS BACKER PLY 2" MIN. FROM TOE OF CANT.
3. *A TERMINATION BAR FASTENED 6" O.C. IS AN ACCEPTABLE SECUREMENT ALTERNATIVE ALONG THE TOP EDGE OF FLASHING.
4. METAL COUNTER FLASHING IS RECOMMENDED FOR ALL INSTALLATIONS AND IS REQUIRED FOR ALL GUARANTEES 15 YEARS OR LONGER. A 3 COURSING OF PERMAFLASH MAY BE USED TO SEAL THE TOP EDGE OF THE FLASHING ON 10 YEAR NDL'S IN LIEU OF METAL COUNTER FLASHING.
5. VERTICAL JOINTS ARE TO BE OVERLAPPED 4" MINIMUM FOR ALL APPLICATIONS. 3 COURSING WITH MBR UTILITY CEMENT AND FABRIC OR JM MBR FLASHING CEMENT IS REQUIRED ON ALL VERTICAL FLASHING LAPS AND INSIDE/OUTSIDE CORNERS EXTENDING PAST LEADING EDGE OF CANT STRIP.
6. ANY CARPENTRY, METAL WORK, OR MASONRY CONSTRUCTION SHOULD BE DESIGNED AND CONSTRUCTED IN ACCORDANCE WITH LOCAL CODE REQUIREMENTS AND/OR PROJECT SPECIFICATIONS. THESE COMPONENTS SHOULD BE REVIEWED AND APPROVED BY A LICENSED DESIGN PROFESSIONAL.
7. PLEASE SEE BITUMINOUS FLASHING SPECIFICATIONS FOR A FULL DESCRIPTION OF INSTALLATION INSTRUCTIONS AND REQUIREMENTS WHICH ARE CONSIDERED A PART OF THIS DETAIL
8. CAUTION: IMPROPER USE OF THESE MATERIALS AND APPLICATION EQUIPMENT CAN RESULT IN SEVERE BURNS, AND/ OR DAMAGE TO PROPERTY. THE MECHANIC MUST INSTALL THESE MATERIALS USING THE TECHNIQUES RECOMMENDED BY JM AND THOSE FOUND IN THE CERTIFIED ROOFING TORCH APPLICATOR (CERTA) PROGRAM AVAILABLE THROUGH THE NATIONAL ROOFING CONTRACTORS ASSOCIATION.

Johns Manville is a manufacturer of commercial roofing products and offers this general conceptual information to you as a courtesy. This complimentary assistance is not to be used or relied upon by anyone as a substitute for professional engineering design and documentation required by building code, contract, or applicable law. By accepting these comments you agree they do not constitute any representations, endorsements of, or an assumption by Johns Manville of any liability for either the adequacy of design of this building or any other material not supplied by Johns Manville.

Note: For the most current information on general guidelines, please refer to the System Considerations tab under Commercial Roofing Products on the JM Roofing Web site. For specifications, flashing details and general installation information please refer to the Application Tools tab.

Refer to the Safe Use Instructions and product label prior to using this product.



TPO Wall Covering with Bituminous Base Flashing

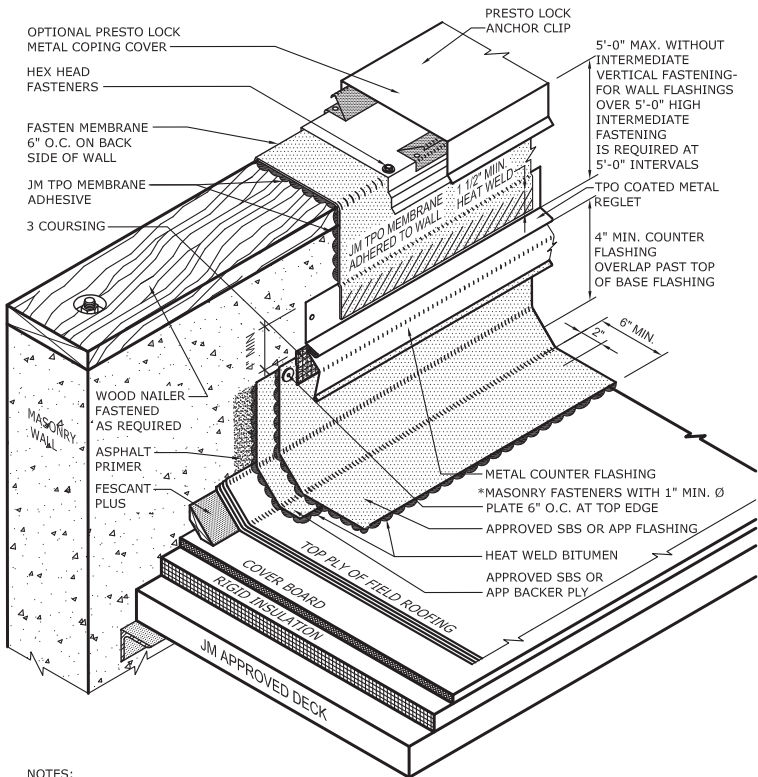

NOTES:

- SBS HEAT WELDED FLASHINGS CAN ONLY BE USED WITH SBS OR BUR SYSTEMS. APP HEAT WELDED FLASHINGS CAN ONLY BE USED WITH APP OR BUR SYSTEMS. (PLEASE REFER TO THE APPROPRIATE TABLE IN THE BITUMINOUS FLASHING SPECIFICATION INDICATING ACCEPTABLE FLASHING PRODUCTS FOR EACH OF THE SBS OR APP HEAT WELDED SYSTEMS.)
- VERTICAL JOINTS ARE TO BE OVERLAPPED 4" MINIMUM FOR ALL APPLICATIONS. 3 COURSING WITH MBR UTILITY CEMENT AND FABRIC OR JM MBR FLASHING CEMENT IS REQUIRED ON ALL VERTICAL FLASHING LAPS AND INSIDE/OUTSIDE CORNERS EXTENDING PAST LEADING EDGE OF CANT STRIP.
- ANY CARPENTRY, METAL WORK, OR MASONRY CONSTRUCTION SHOULD BE DESIGNED AND CONSTRUCTED IN ACCORDANCE WITH LOCAL CODE REQUIREMENTS AND/OR PROJECT SPECIFICATIONS. THESE COMPONENTS SHOULD BE REVIEWED AND APPROVED BY A LICENSED DESIGN PROFESSIONAL.
- INSTALL PRESTO LOCK COPING IN ACCORDANCE WITH INSTALLATION INSTRUCTIONS INCLUDED WITH THE PRODUCT. PREFABRICATED INSIDE/OUTSIDE CORNERS AND END CAPS ARE AVAILABLE TO COMPLETE THE INSTALLATION. SHOP FABRICATED COPINGS SHOULD BE INSTALLED IN ACCORDANCE WITH SMACNA GUIDELINES.
- PLEASE SEE BITUMINOUS FLASHING SPECIFICATIONS FOR A FULL DESCRIPTION OF INSTALLATION INSTRUCTIONS AND REQUIREMENTS WHICH ARE CONSIDERED A PART OF THIS DETAIL.
- *A TERMINATION BAR FASTENED 6" O.C. IS AN ACCEPTABLE SECUREMENT ALTERNATIVE ALONG THE TOP EDGE OF THE FLASHING.
- CAUTION: IMPROPER USE OF THESE MATERIALS AND APPLICATION EQUIPMENT CAN RESULT IN SEVERE BURNS, AND/OR DAMAGE TO PROPERTY. THE MECHANIC MUST INSTALL THESE MATERIALS USING THE TECHNIQUES RECOMMENDED BY JM AND THOSE FOUND IN THE CERTIFIED ROOFING TORCH APPLICATOR (CERTA) PROGRAM AVAILABLE THROUGH THE NATIONAL ROOFING CONTRACTORS ASSOCIATION.

Johns Manville is a manufacturer of commercial roofing products and offers this general conceptual information to you as a courtesy. This complimentary assistance is not to be used or relied upon by anyone as a substitute for professional engineering design and documentation required by building code, contract, or applicable law. By accepting these comments you agree they do not constitute any representations, endorsements of, or an assumption by Johns Manville of any liability for either the adequacy of design of this building or any other material not supplied by Johns Manville.

Note: For the most current information on general guidelines, please refer to the System Considerations tab under Commercial Roofing Products on the JM Roofing Web site. For specifications, flashing details and general installation information please refer to the Application Tools tab.

Refer to the Safe Use Instructions and product label prior to using this product.



TPO Wall Covering with Bituminous Base Flashing

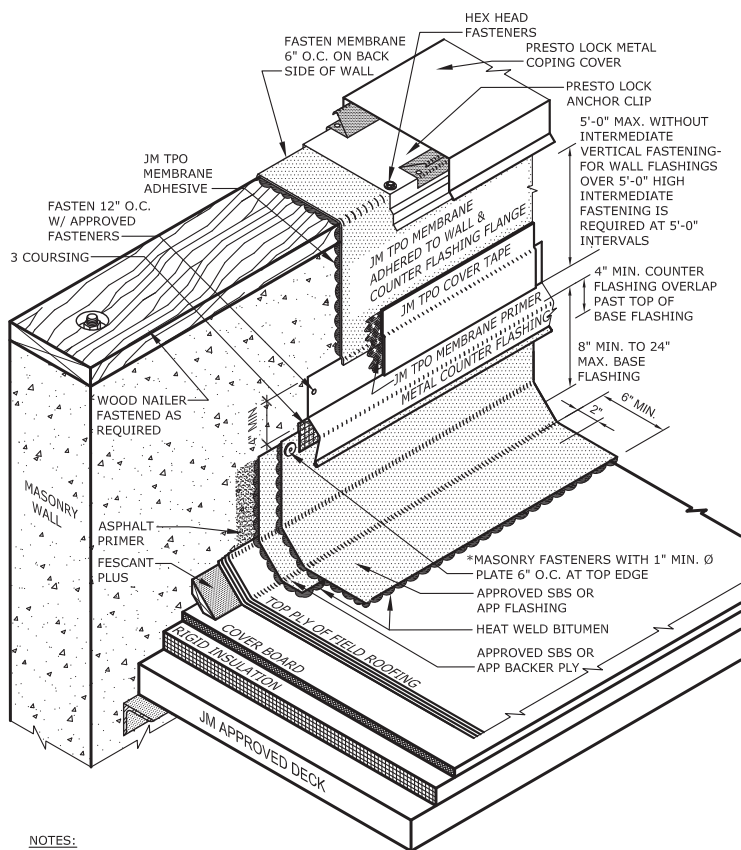

NOTES:

1. SBS HEAT WELDED FLASHINGS CAN ONLY BE USED WITH SBS OR BUR SYSTEMS. APP HEAT WELDED FLASHINGS CAN ONLY BE USED WITH APP OR BUR SYSTEMS. (PLEASE REFER TO THE APPROPRIATE TABLE IN THE BITUMINOUS FLASHING SPECIFICATION INDICATING ACCEPTABLE FLASHING PRODUCTS FOR EACH OF THE SBS OR APP HEAT WELDED SYSTEMS.)
2. VERTICAL JOINTS ARE TO BE OVERLAPPED 4" MINIMUM FOR ALL APPLICATIONS. 3 COURSING WITH MBR UTILITY CEMENT AND FABRIC OR JM MBR FLASHING CEMENT IS REQUIRED ON ALL VERTICAL FLASHING LAPS AND INSIDE/OUTSIDE CORNERS EXTENDING PAST LEADING EDGE OF CANT STRIP.
3. ANY CARPENTRY, METAL WORK, OR MASONRY CONSTRUCTION SHOULD BE DESIGNED AND CONSTRUCTED IN ACCORDANCE WITH LOCAL CODE REQUIREMENTS AND/OR PROJECT SPECIFICATIONS. THESE COMPONENTS SHOULD BE REVIEWED AND APPROVED BY A LICENSED DESIGN PROFESSIONAL.
4. INSTALL PRESTO LOCK COPING IN ACCORDANCE WITH INSTALLATION INSTRUCTIONS INCLUDED WITH THE PRODUCT. PREFABRICATED INSIDE/OUTSIDE CORNERS AND END CAPS ARE AVAILABLE TO COMPLETE THE INSTALLATION. SHOP FABRICATED COPINGS SHOULD BE INSTALLED IN ACCORDANCE WITH SMACNA GUIDELINES.
5. PLEASE SEE BITUMINOUS FLASHING SPECIFICATIONS FOR A FULL DESCRIPTION OF INSTALLATION INSTRUCTIONS AND REQUIREMENTS WHICH ARE CONSIDERED A PART OF THIS DETAIL
- 6.*A TERMINATION BAR FASTENED 6" O.C. IS AN ACCEPTABLE SECUREMENT ALTERNATIVE ALONG THE TOP EDGE OF THE FLASHING.
7. CAUTION: IMPROPER USE OF THESE MATERIALS AND APPLICATION EQUIPMENT CAN RESULT IN SEVERE BURNS, AND/OR DAMAGE TO PROPERTY. THE MECHANIC MUST INSTALL THESE MATERIALS USING THE TECHNIQUES RECOMMENDED BY JM AND THOSE FOUND IN THE CERTIFIED ROOFING TORCH APPLICATOR (CERTA) PROGRAM AVAILABLE THROUGH THE NATIONAL ROOFING CONTRACTORS ASSOCIATION.

Johns Manville is a manufacturer of commercial roofing products and offers this general conceptual information to you as a courtesy. This complimentary assistance is not to be used or relied upon by anyone as a substitute for professional engineering design and documentation required by building code, contract, or applicable law. By accepting these comments you agree they do not constitute any representations, endorsements of, or an assumption by Johns Manville of any liability for either the adequacy of design of this building or any other material not supplied by Johns Manville.

Note: For the most current information on general guidelines, please refer to the System Considerations tab under Commercial Roofing Products on the JM Roofing Web site. For specifications, flashing details and general installation information please refer to the Application Tools tab.

Refer to the Safe Use Instructions and product label prior to using this product.



Venting Lightweight Concrete

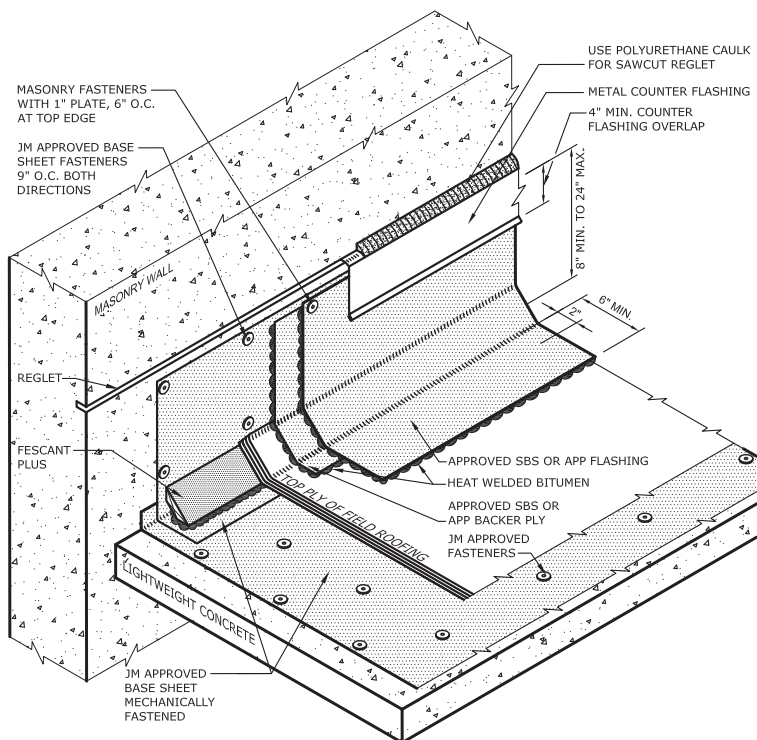

NOTES:

1. SBS HEAT WELDED FLASHINGS CAN ONLY BE USED WITH SBS OR BUR SYSTEMS. APP HEAT WELDED FLASHINGS CAN ONLY BE USED WITH APP OR BUR SYSTEMS. (PLEASE REFER TO THE APPROPRIATE TABLE IN THE BITUMINOUS FLASHING SPECIFICATION INDICATING ACCEPTABLE FLASHING PRODUCTS FOR EACH OF THE SBS OR APP HEAT WELDED SYSTEMS.)
2. EXTEND VENTILATION ONE INCH MIN. PAST TOP OF BASEFLASHING TO PROMOTE AIRFLOW.
3. A TERMINATION BAR FASTENED 6" O.C. IS AN ACCEPTABLE SECUREMENT ALTERNATIVE ALONG THE TOP EDGE OF THE FLASHING.*
4. METAL COUNTER FLASHING IS RECOMMENDED FOR ALL INSTALLATIONS AND IS REQUIRED FOR ALL GUARANTEES 15 YEARS OR LONGER. A 3 COURSING OF PERMAFLASH MAY BE USED TO SEAL THE TOP EDGE OF THE FLASHING ON 10 YEAR NDL'S IN LIEU OF METAL COUNTER FLASHING.
5. VERTICAL JOINTS ARE TO BE OVERLAPPED 4" MINIMUM FOR ALL APPLICATIONS. 3 COURSING WITH MBR UTILITY CEMENT AND FABRIC OR JM MBR FLASHING CEMENT IS REQUIRED ON ALL VERTICAL FLASHING LAPS AND INSIDE/OUTSIDE CORNERS EXTENDING PAST LEADING EDGE OF CANT STRIP.
6. ANY CARPENTRY, METAL WORK, OR MASONRY CONSTRUCTION SHOULD BE DESIGNED AND CONSTRUCTED IN ACCORDANCE WITH LOCAL CODE REQUIREMENTS AND/OR PROJECT SPECIFICATIONS. THESE COMPONENTS SHOULD BE REVIEWED AND APPROVED BY A LICENSED DESIGN PROFESSIONAL.
7. PLEASE SEE BITUMINOUS FLASHING SPECIFICATIONS FOR A FULL DESCRIPTION OF INSTALLATION INSTRUCTIONS AND REQUIREMENTS WHICH ARE CONSIDERED A PART OF THIS DETAIL.
8. CAUTION: IMPROPER USE OF THESE MATERIALS AND APPLICATION EQUIPMENT CAN RESULT IN SEVERE BURNS, AND/OR DAMAGE TO PROPERTY. THE MECHANIC MUST INSTALL THESE MATERIALS USING THE TECHNIQUES RECOMMENDED BY JM AND THOSE FOUND IN THE CERTIFIED ROOFING TORCH APPLICATOR (CERTA) PROGRAM AVAILABLE THROUGH THE NATIONAL ROOFING CONTRACTORS ASSOCIATION.

Johns Manville is a manufacturer of commercial roofing products and offers this general conceptual information to you as a courtesy. This complimentary assistance is not to be used or relied upon by anyone as a substitute for professional engineering design and documentation required by building code, contract, or applicable law. By accepting these comments you agree they do not constitute any representations, endorsements of, or an assumption by Johns Manville of any liability for either the adequacy of design of this building or any other material not supplied by Johns Manville.

Note: For the most current information on general guidelines, please refer to the System Considerations tab under Commercial Roofing Products on the JM Roofing Web site. For specifications, flashing details and general installation information please refer to the Application Tools tab.

Refer to the Safe Use Instructions and product label prior to using this product.



Wood Wall >24" with Coping

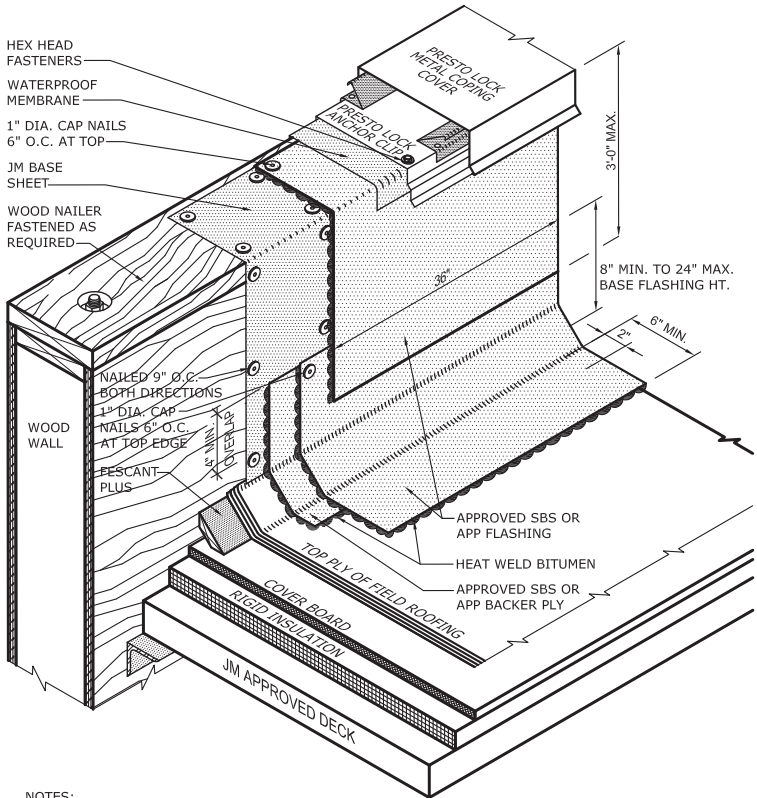

NOTES:

1. SBS HEAT WELDED FLASHINGS CAN ONLY BE USED WITH SBS OR BUR SYSTEMS. APP HEAT WELDED FLASHINGS CAN ONLY BE USED WITH APP OR BUR SYSTEMS. (PLEASE REFER TO THE APPROPRIATE TABLE IN THE BITUMINOUS FLASHING SPECIFICATION INDICATING ACCEPTABLE FLASHING PRODUCTS FOR EACH OF THE SBS OR APP HEAT WELDED SYSTEMS.)
2. VERTICAL JOINTS ARE TO BE OVERLAPPED 4" MINIMUM FOR ALL APPLICATIONS. 3 COURSING WITH MBR UTILITY CEMENT AND FABRIC OR JM MBR FLASHING CEMENT IS REQUIRED ON ALL VERTICAL FLASHING LAPS AND INSIDE/OUTSIDE CORNERS EXTENDING PAST LEADING EDGE OF CANT STRIP.
3. ANY CARPENTRY, METAL WORK, OR MASONRY CONSTRUCTION SHOULD BE DESIGNED AND CONSTRUCTED IN ACCORDANCE WITH LOCAL CODE REQUIREMENTS AND/OR PROJECT SPECIFICATIONS. THESE COMPONENTS SHOULD BE REVIEWED AND APPROVED BY A LICENSED DESIGN PROFESSIONAL.
4. INSTALL PRESTO LOCK COPING IN ACCORDANCE WITH INSTALLATION INSTRUCTIONS INCLUDED WITH THE PRODUCT. PREFABRICATED INSIDE/OUTSIDE CORNERS AND END CAPS ARE AVAILABLE TO COMPLETE THE INSTALLATION. SHOP FABRICATED COPINGS SHOULD BE INSTALLED IN ACCORDANCE WITH SMACNA GUIDELINES.
5. PLEASE SEE BITUMINOUS FLASHING SPECIFICATIONS FOR A FULL DESCRIPTION OF INSTALLATION INSTRUCTIONS AND REQUIREMENTS WHICH ARE CONSIDERED A PART OF THIS DETAIL.
6. CAUTION: IMPROPER USE OF THESE MATERIALS AND APPLICATION EQUIPMENT CAN RESULT IN SEVERE BURNS, AND/ OR DAMAGE TO PROPERTY. THE MECHANIC MUST INSTALL THESE MATERIALS USING THE TECHNIQUES RECOMMENDED BY JM AND THOSE FOUND IN THE CERTIFIED ROOFING TORCH APPLICATOR (CERTA) PROGRAM AVAILABLE THROUGH THE NATIONAL ROOFING CONTRACTORS ASSOCIATION.

Johns Manville is a manufacturer of commercial roofing products and offers this general conceptual information to you as a courtesy. This complimentary assistance is not to be used or relied upon by anyone as a substitute for professional engineering design and documentation required by building code, contract, or applicable law. By accepting these comments you agree they do not constitute any representations, endorsements of, or an assumption by Johns Manville of any liability for either the adequacy of design of this building or any other material not supplied by Johns Manville.

Note: For the most current information on general guidelines, please refer to the System Considerations tab under Commercial Roofing Products on the JM Roofing Web site. For specifications, flashing details and general installation information please refer to the Application Tools tab.

Refer to the Safe Use Instructions and product label prior to using this product.



Wood Wall <24" with Coping

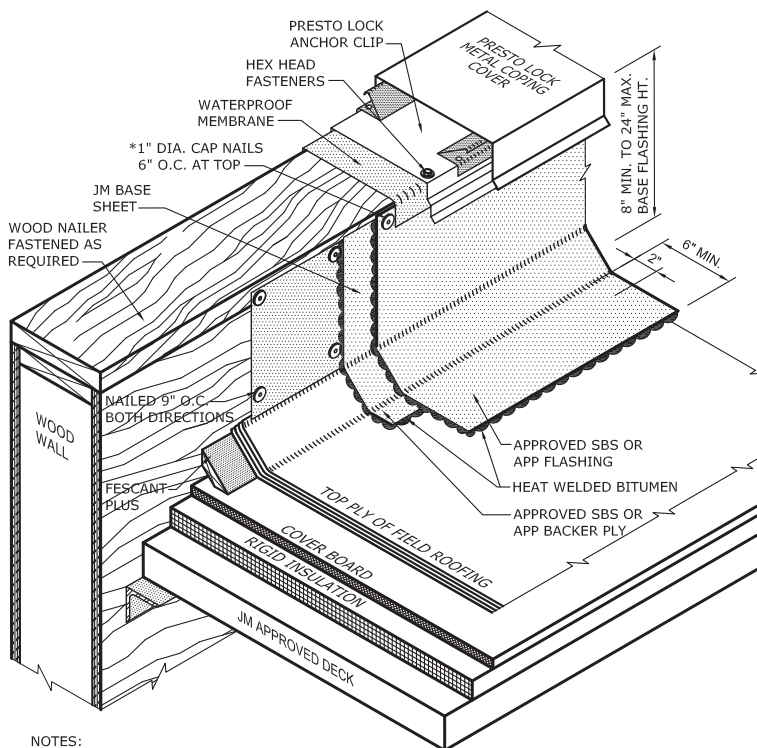

NOTES:

1. SBS HEAT WELDED FLASHINGS CAN ONLY BE USED WITH SBS OR BUR SYSTEMS. APP HEAT WELDED FLASHINGS CAN ONLY BE USED WITH APP OR BUR SYSTEMS. (PLEASE REFER TO THE APPROPRIATE TABLE IN THE BITUMINOUS FLASHING SPECIFICATION INDICATING ACCEPTABLE FLASHING PRODUCTS FOR EACH OF THE SBS OR APP HEAT WELDED SYSTEMS.)
2. A TERMINATION BAR FASTENED 6" O.C. IS AN ACCEPTABLE SECUREMENT ALTERNATIVE ALONG THE TOP EDGE OF THE CEILING.
3. VERTICAL JOINTS ARE TO BE OVERLAPPED 4" MINIMUM FOR ALL APPLICATIONS. 3 COURSING WITH MBR UTILITY CEMENT AND FABRIC OR JM MBR FLASHING CEMENT IS REQUIRED ON ALL VERTICAL FLASHING LAPS AND INSIDE/OUTSIDE CORNERS EXTENDING PAST LEADING EDGE OF CANT STRIP.
4. ANY CARPENTRY, METAL WORK, OR MASONRY CONSTRUCTION SHOULD BE DESIGNED AND CONSTRUCTED IN ACCORDANCE WITH LOCAL CODE REQUIREMENTS AND/OR PROJECT SPECIFICATIONS THESE COMPONENTS SHOULD BE REVIEWED AND APPROVED BY A LICENSED DESIGN PROFESSIONAL.
5. INSTALL PRESTO LOCK COPING IN ACCORDANCE WITH INSTALLATION INSTRUCTIONS INCLUDED WITH THE PRODUCT. PREFABRICATED INSIDE/OUTSIDE CORNERS AND END CAPS ARE AVAILABLE TO COMPLETE THE INSTALLATION. SHOP FABRICATED COPINGS SHOULD BE INSTALLED IN ACCORDANCE WITH SMACNA GUIDELINES.
6. PLEASE SEE BITUMINOUS FLASHING SPECIFICATIONS FOR A FULL DESCRIPTION OF INSTALLATION INSTRUCTIONS AND REQUIREMENTS WHICH ARE CONSIDERED A PART OF THIS DETAIL
7. CAUTION: IMPROPER USE OF THESE MATERIALS AND APPLICATION EQUIPMENT CAN RESULT IN SEVERE BURNS, AND/ OR DAMAGE TO PROPERTY. THE MECHANIC MUST INSTALL THESE MATERIALS USING THE TECHNIQUES RECOMMENDED BY JM AND THOSE FOUND IN THE CERTIFIED ROOFING TORCH APPLICATOR (CERTA) PROGRAM AVAILABLE THROUGH THE NATIONAL ROOFING CONTRACTORS ASSOCIATION.

Johns Manville is a manufacturer of commercial roofing products and offers this general conceptual information to you as a courtesy. This complimentary assistance is not to be used or relied upon by anyone as a substitute for professional engineering design and documentation required by building code, contract, or applicable law. By accepting these comments you agree they do not constitute any representations, endorsements of, or an assumption by Johns Manville of any liability for either the adequacy of design of this building or any other material not supplied by Johns Manville.

Note: For the most current information on general guidelines, please refer to the System Considerations tab under Commercial Roofing Products on the JM Roofing Web site. For specifications, flashing details and general installation information please refer to the Application Tools tab.

Refer to the Safe Use Instructions and product label prior to using this product.



Curb to Wall E.J.

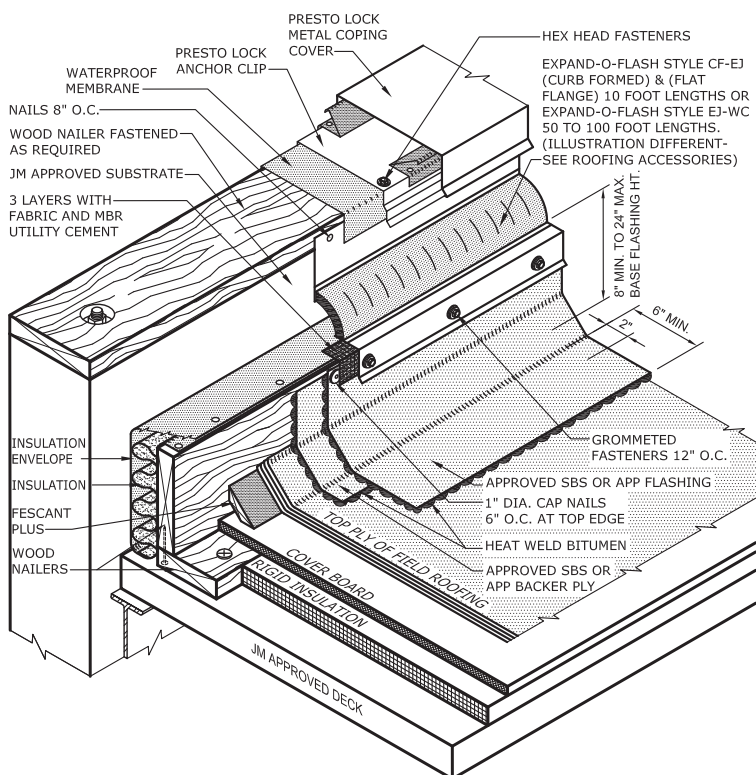

NOTES:

- SBS HEAT WELDED FLASHINGS CAN ONLY BE USED WITH SBS OR BUR SYSTEMS. APP HEAT WELDED FLASHINGS CAN ONLY BE USED WITH APP OR BUR SYSTEMS. (PLEASE REFER TO THE APPROPRIATE TABLE IN THE BITUMINOUS FLASHING SPECIFICATION INDICATING ACCEPTABLE FLASHING PRODUCTS FOR EACH OF THE SBS OR APP HEAT WELDED SYSTEMS.)
- VERTICAL JOINTS ARE TO BE OVERLAPPED 4" MINIMUM FOR ALL APPLICATIONS. 3 COURSING WITH MBR UTILITY CEMENT AND FABRIC OR JM MBR FLASHING CEMENT IS REQUIRED ON ALL VERTICAL FLASHING LAPS AND INSIDE/OUTSIDE CORNERS EXTENDING PAST LEADING EDGE OF CANT STRIP.
- ANY CARPENTRY, METAL WORK, OR MASONRY CONSTRUCTION SHOULD BE DESIGNED AND CONSTRUCTED IN ACCORDANCE WITH LOCAL CODE REQUIREMENTS AND/OR PROJECT SPECIFICATIONS. THESE COMPONENTS SHOULD BE REVIEWED AND APPROVED BY A LICENSED DESIGN PROFESSIONAL.
- INSTALL EXPAND-O-FLASH IN ACCORDANCE WITH APPLICATION INSTRUCTIONS INCLUDED WITH THE PRODUCT. PREFABRICATED TRANSITIONS, INSIDE/OUTSIDE CORNERS, ETC. ARE AVAILABLE TO COMPLETE THE INSTALLATION.
- INSTALL PRESTO LOCK COPING IN ACCORDANCE WITH INSTALLATION INSTRUCTIONS INCLUDED WITH THE PRODUCT. PREFABRICATED INSIDE/OUTSIDE CORNERS AND END CAPS ARE AVAILABLE TO COMPLETE THE INSTALLATION. SHOP FABRICATED COPINGS SHOULD BE INSTALLED IN ACCORDANCE WITH SMACNA GUIDELINES.
- PLEASE SEE BITUMINOUS FLASHING SPECIFICATIONS FOR A FULL DESCRIPTION OF INSTALLATION INSTRUCTIONS AND REQUIREMENTS WHICH ARE CONSIDERED A PART OF THIS DETAIL
- CAUTION: IMPROPER USE OF THESE MATERIALS AND APPLICATION EQUIPMENT CAN RESULT IN SEVERE BURNS, AND/ OR DAMAGE TO PROPERTY. THE MECHANIC MUST INSTALL THESE MATERIALS USING THE TECHNIQUES RECOMMENDED BY JM AND THOSE FOUND IN THE CERTIFIED ROOFING TORCH APPLICATOR (CERTA) PROGRAM AVAILABLE THROUGH THE NATIONAL ROOFING CONTRACTORS ASSOCIATION.

Johns Manville is a manufacturer of commercial roofing products and offers this general conceptual information to you as a courtesy. This complimentary assistance is not to be used or relied upon by anyone as a substitute for professional engineering design and documentation required by building code, contract, or applicable law. By accepting these comments you agree they do not constitute any representations, endorsements of, or an assumption by Johns Manville of any liability for either the adequacy of design of this building or any other material not supplied by Johns Manville.

Note: For the most current information on general guidelines, please refer to the System Considerations tab under Commercial Roofing Products on the JM Roofing Web site. For specifications, flashing details and general installation information please refer to the Application Tools tab.

Refer to the Safe Use Instructions and product label prior to using this product.



Metal E.J. Alternate

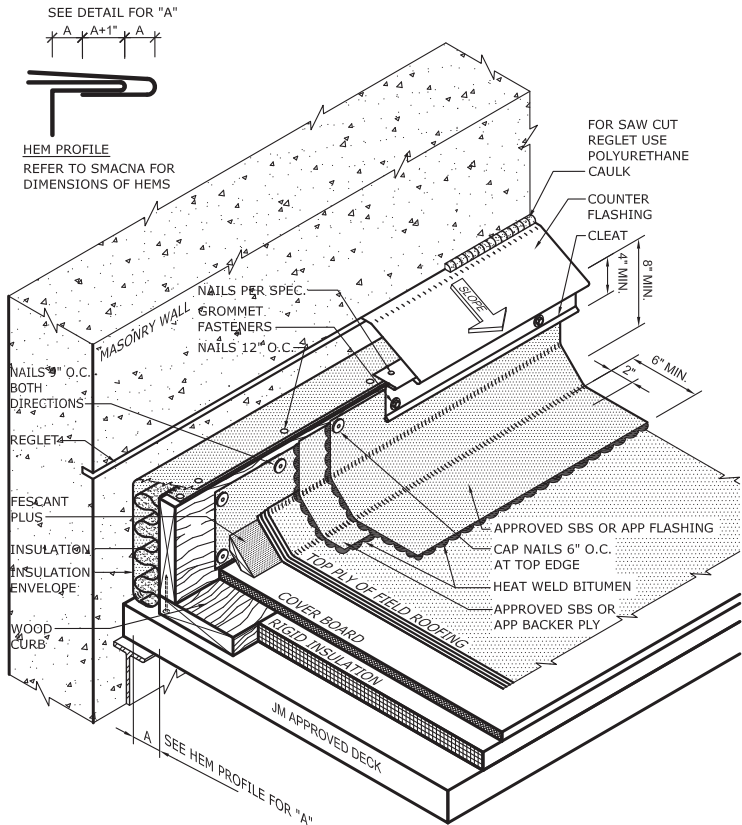

NOTES:

1. SBS HEAT WELDED FLASHINGS CAN ONLY BE USED WITH SBS OR BUR SYSTEMS. APP HEAT WELDED FLASHINGS CAN ONLY BE USED WITH APP OR BUR SYSTEMS. (PLEASE REFER TO THE APPROPRIATE TABLE IN THE BITUMINOUS FLASHING SPECIFICATION INDICATING ACCEPTABLE FLASHING PRODUCTS FOR EACH OF THE SBS OR APP HEAT WELDED SYSTEMS.)
2. THE VERTICAL WOOD CURB SHOULD BE FASTENED TO THE DECK ONLY.
3. VERTICAL JOINTS ARE TO BE OVERLAPPED 4" MINIMUM FOR ALL APPLICATIONS. 3 COURSING WITH MBR UTILITY CEMENT AND FABRIC OR JM MBR FLASHING CEMENT IS REQUIRED ON ALL VERTICAL FLASHING LAPS AND INSIDE/OUTSIDE CORNERS EXTENDING PAST LEADING EDGE OF CANT STRIP.
4. ANY CARPENTRY, METAL WORK, OR MASONRY CONSTRUCTION SHOULD BE DESIGNED AND CONSTRUCTED IN ACCORDANCE WITH LOCAL CODE REQUIREMENTS AND/OR PROJECT SPECIFICATIONS. THESE COMPONENTS SHOULD BE REVIEWED AND APPROVED BY A LICENSED DESIGN PROFESSIONAL.
5. SHOP FABRICATED GRAVEL STOP SHOULD BE INSTALLED IN ACCORDANCE WITH SMACNA AND/OR NRCA GUIDELINES. LAPS SHALL UTILIZE EITHER APPROVED SPLICE PLATES OR 4" MINIMUM OVERLAPS WITH APPROVED SEALANT.
6. PLEASE SEE BITUMINOUS FLASHING SPECIFICATIONS FOR A FULL DESCRIPTION OF INSTALLATION INSTRUCTIONS AND REQUIREMENTS WHICH ARE CONSIDERED A PART OF THIS DETAIL
7. CAUTION: IMPROPER USE OF THESE MATERIALS AND APPLICATION EQUIPMENT CAN RESULT IN SEVERE BURNS, AND/ OR DAMAGE TO PROPERTY. THE MECHANIC MUST INSTALL THESE MATERIALS USING THE TECHNIQUES RECOMMENDED BY JM AND THOSE FOUND IN THE CERTIFIED ROOFING TORCH APPLICATOR (CERTA) PROGRAM AVAILABLE THROUGH THE NATIONAL ROOFING CONTRACTORS ASSOCIATION.

Johns Manville is a manufacturer of commercial roofing products and offers this general conceptual information to you as a courtesy. This complimentary assistance is not to be used or relied upon by anyone as a substitute for professional engineering design and documentation required by building code, contract, or applicable law. By accepting these comments you agree they do not constitute any representations, endorsements of, or an assumption by Johns Manville of any liability for either the adequacy of design of this building or any other material not supplied by Johns Manville.

Note: For the most current information on general guidelines, please refer to the System Considerations tab under Commercial Roofing Products on the JM Roofing Web site. For specifications, flashing details and general installation information please refer to the Application Tools tab.

Refer to the Safe Use Instructions and product label prior to using this product.

Introduction

Vapor barriers can play an important role in the construction of a roof system and proper installation of these products are critical to their performance. Although many products can be used as a vapor barrier, this installation guide is specific to the JM Vapor Barrier SA product and the corresponding primers, SA Primer and SA Primer Low VOC.

General Application Instructions

Surface Preparation: All surfaces must be swept clean and free from oil, grease, rust, scale, loose paint and dirt. **NOTE:** If the material has been left exposed, the membrane must be free of dust, frost or any other debris prior to application of any adhesives to the top surface. The surface may need to be broomed or cleaned with a light rinse and allowed to dry prior to application of any adhesives. An adhesion test may need to be performed to determine if the polyethylene is a viable substrate.

Primer

SA Primer and SA Primer Low VOC must be mixed well before use. Do not thin. Please see data sheet for coverage information. Apply with a roller or a spray can. Primers should be applied uniform with no streaks or puddles. Allow to dry completely. Do not accelerate drying of primers by heating with a torch. Primer should be tacky but should not transfer to a clean dry finger.

Vapor Barrier SA

Roll out Vapor Barrier SA membrane over the areas that have received the SA Primer or SA Primer Low VOC. Be sure to stagger the end laps and overlap the side laps by a minimum of 3". Once the membrane is in the desired location, hold the membrane tight while peeling away the silicone release liner at an angle. Install additional rolls in the same way, with 3" side laps and 6" end laps. A minimum 75 lb split linoleum roller should be used over the entire surface and a 4" rubber roller should be used in the overlap areas.

Clean Up

Tools can be cleaned with petroleum solvents such as mineral spirits. Use care when handling solvents. Clean hands with waterless hand cleaner.



JM Vapor Barrier SA - Wall Base Detail

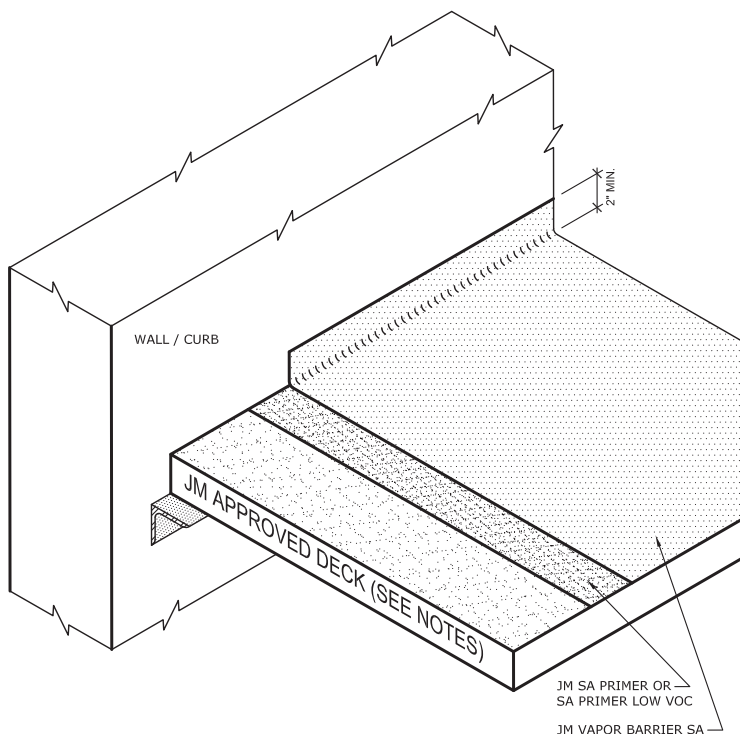

NOTES

1. USE DETAIL IN CONJUNCTION WITH THE STANDARD CURB DETAIL FOR APPROVED ROOF SYSTEM.
2. REFER TO JM VAPOR BARRIER AND PRIMER INSTALLATION INSTRUCTIONS FOR GENERAL GUIDELINES REGARDING THESE SYSTEMS.
3. FOR STEEL DECK SYSTEMS IT IS REQUIRED TO HAVE A MINIMUM OF 1/2" THERMAL BARRIER FASTENED TO STEEL DECK BEFORE JM VAPOR BARRIER IS ADHERED.

Johns Manville is a manufacturer of commercial roofing products and offers this general conceptual information to you as a courtesy. This complimentary assistance is not to be used or relied upon by anyone as a substitute for professional engineering design and documentation required by building code, contract, or applicable law. By accepting these comments you agree they do not constitute any representations, endorsements of, or an assumption by Johns Manville of any liability for either the adequacy of design of this building or any other material not supplied by Johns Manville.

Note: For the most current information on general guidelines, please refer to the System Considerations tab under Commercial Roofing Products on the JM Roofing Web site. For specifications, flashing details and general installation information please refer to the Application Tools tab.

Refer to the Safe Use Instructions and product label prior to using this product.



JM Vapor Barrier SA - Wall Base Detail (Alt)

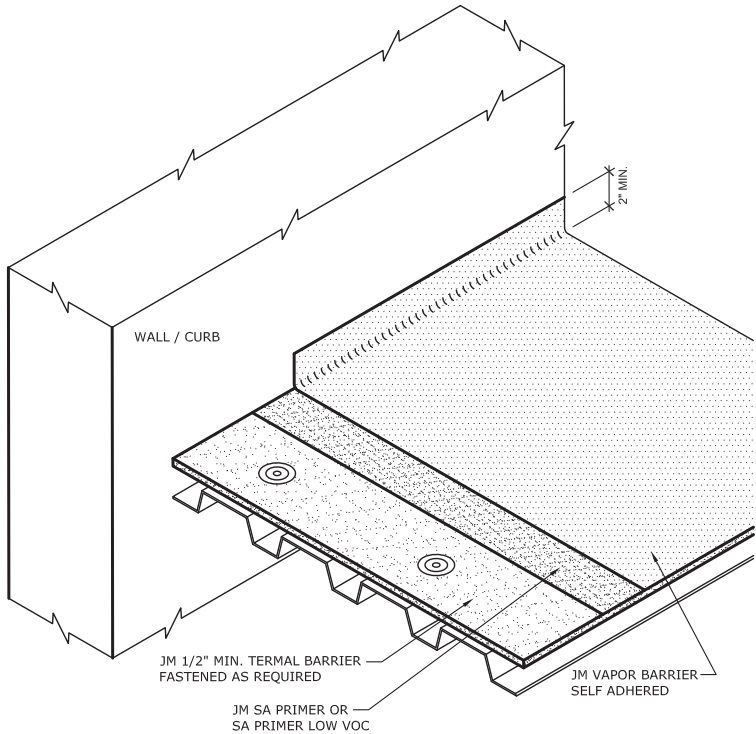

NOTES

1. USE DETAIL IN CONJUNCTION WITH THE STANDARD CURB DETAIL FOR APPROVED ROOF SYSTEM.
2. REFER TO JM VAPOR BARRIER AND PRIMER INSTALLATION INSTRUCTIONS FOR GENERAL GUIDELINES REGARDING THESE SYSTEMS.
3. FOR STEEL DECK SYSTEMS IT IS REQUIRED TO HAVE A MINIMUM OF 1/2" THERMAL BARRIER FASTENED TO STEEL DECK BEFORE JM VAPOR BARRIER IS ADHERED.

Johns Manville is a manufacturer of commercial roofing products and offers this general conceptual information to you as a courtesy. This complimentary assistance is not to be used or relied upon by anyone as a substitute for professional engineering design and documentation required by building code, contract, or applicable law. By accepting these comments you agree they do not constitute any representations, endorsements of, or an assumption by Johns Manville of any liability for either the adequacy of design of this building or any other material not supplied by Johns Manville.

Note: For the most current information on general guidelines, please refer to the System Considerations tab under Commercial Roofing Products on the JM Roofing Web site. For specifications, flashing details and general installation information please refer to the Application Tools tab.

Refer to the Safe Use Instructions and product label prior to using this product.



JM Vapor Barrier SA - Pipe Penetration Detail

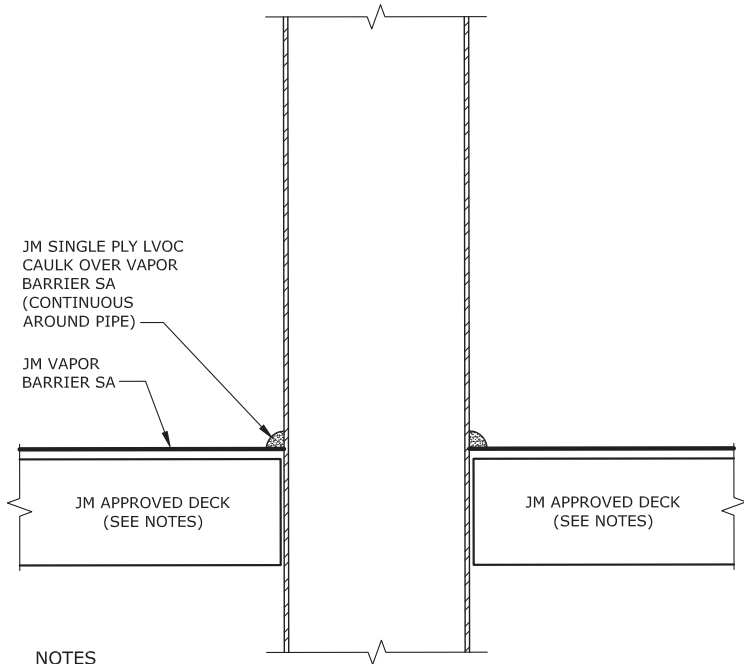

NOTES

1. USE DETAIL IN CONJUNCTION WITH THE STANDARD CURB DETAIL FOR APPROVED ROOF SYSTEM.
2. REFER TO JM VAPOR BARRIER AND PRIMER INSTALLATION INSTRUCTIONS FOR GENERAL GUIDELINES REGARDING THESE SYSTEMS.
3. FOR STEEL DECK SYSTEMS IT IS REQUIRED TO HAVE A MINIMUM OF 1/2" THERMAL BARRIER FASTENED TO STEEL DECK BEFORE JM VAPOR BARRIER IS ADHERED.

Johns Manville is a manufacturer of commercial roofing products and offers this general conceptual information to you as a courtesy. This complimentary assistance is not to be used or relied upon by anyone as a substitute for professional engineering design and documentation required by building code, contract, or applicable law. By accepting these comments you agree they do not constitute any representations, endorsements of, or an assumption by Johns Manville of any liability for either the adequacy of design of this building or any other material not supplied by Johns Manville.

Note: For the most current information on general guidelines, please refer to the System Considerations tab under Commercial Roofing Products on the JM Roofing Web site. For specifications, flashing details and general installation information please refer to the Application Tools tab.

Refer to the Safe Use Instructions and product label prior to using this product.



JM Vapor Barrier SA - Drain Detail

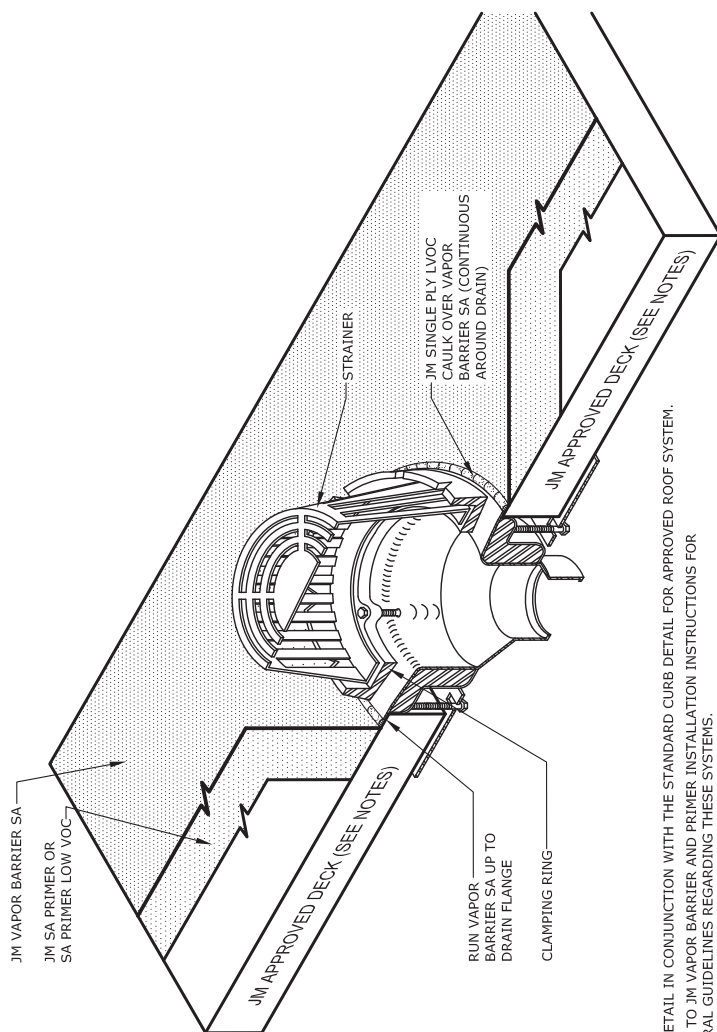

NOTES

1. USE DETAIL IN CONJUNCTION WITH THE STANDARD CURB DETAIL FOR APPROVED ROOF SYSTEM.
2. REFER TO JM VAPOR BARRIER AND PRIMER INSTALLATION INSTRUCTIONS FOR GENERAL GUIDELINES REGARDING THESE SYSTEMS.
3. FOR STEEL DECK SYSTEMS IT IS REQUIRED TO HAVE A MINIMUM OF 1/2" THERMAL BARRIER FASTENED TO STEEL DECK BEFORE JM VAPOR BARRIER IS ADHERED.

Johns Manville is a manufacturer of commercial roofing products and offers this general conceptual information to you as a courtesy. This complimentary assistance is not to be used or relied upon by anyone as a substitute for professional engineering design and documentation required by building code, contract, or applicable law. By accepting these comments you agree they do not constitute any representations, endorsements of, or an assumption by Johns Manville of any liability for either the adequacy of design of this building or any other material not supplied by Johns Manville.

Note: For the most current information on general guidelines, please refer to the System Considerations tab under Commercial Roofing Products on the JM Roofing Web site. For specifications, flashing details and general installation information please refer to the Application Tools tab.

Refer to the Safe Use Instructions and product label prior to using this product.



JM Vapor Barrier SA - Detail at Field Laps

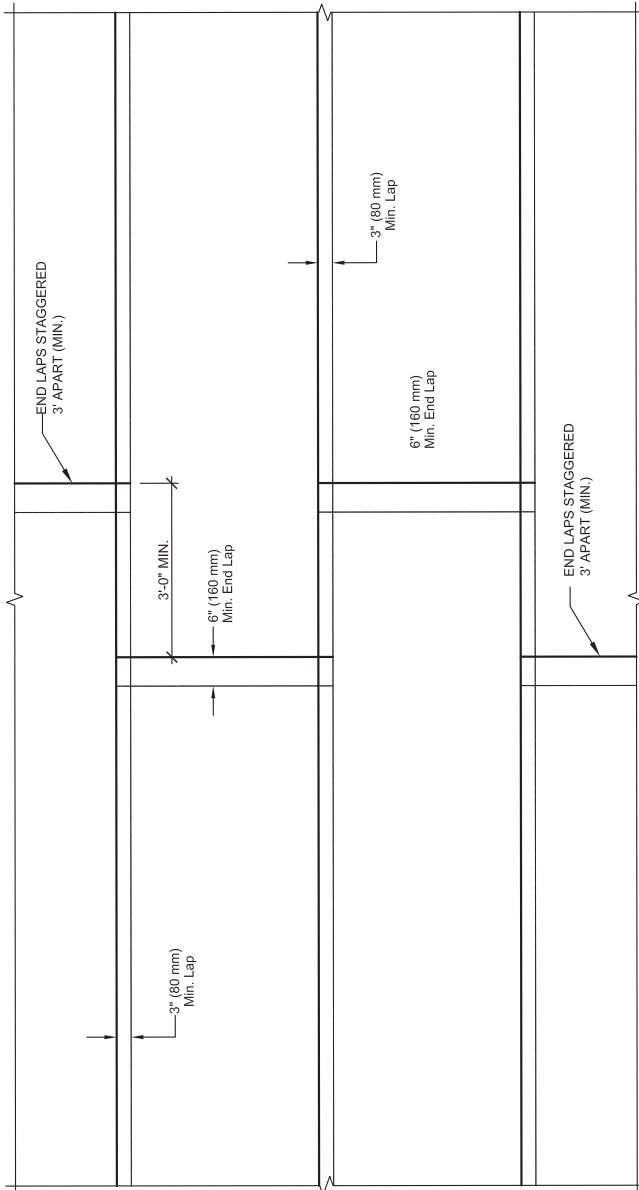

Johns Manville is a manufacturer of commercial roofing products and offers this general conceptual information to you as a courtesy. This complimentary assistance is not to be used or relied upon by anyone as a substitute for professional engineering design and documentation required by building code, contract, or applicable law. By accepting these comments you agree they do not constitute any representations, endorsements of, or an assumption by Johns Manville of any liability for either the adequacy of design of this building or any other material not supplied by Johns Manville.

Note: For the most current information on general guidelines, please refer to the System Considerations tab under Commercial Roofing Products on the JM Roofing Web site. For specifications, flashing details and general installation information please refer to the Application Tools tab.

Refer to the Safe Use Instructions and product label prior to using this product.



JM Vapor Barrier SA - Outside Curb Detail

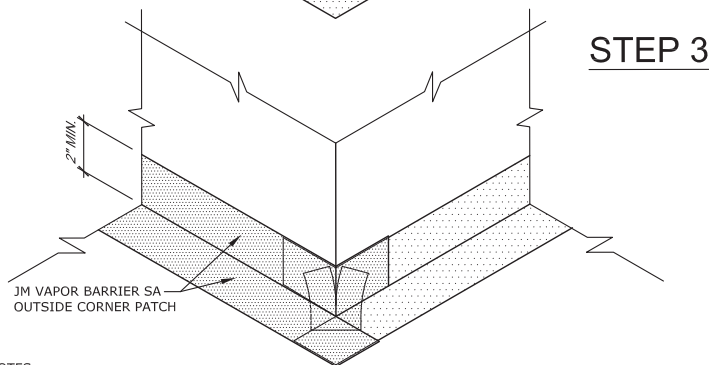
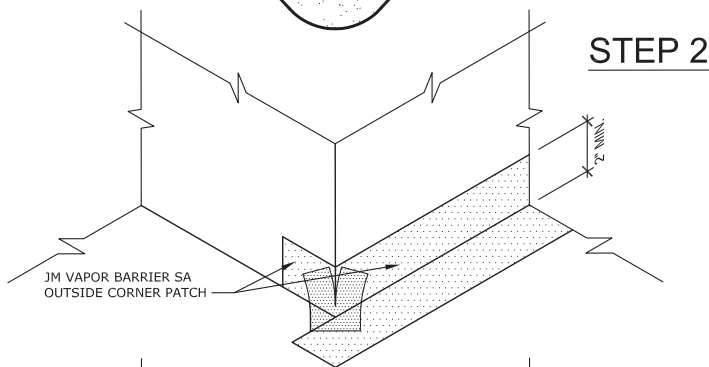
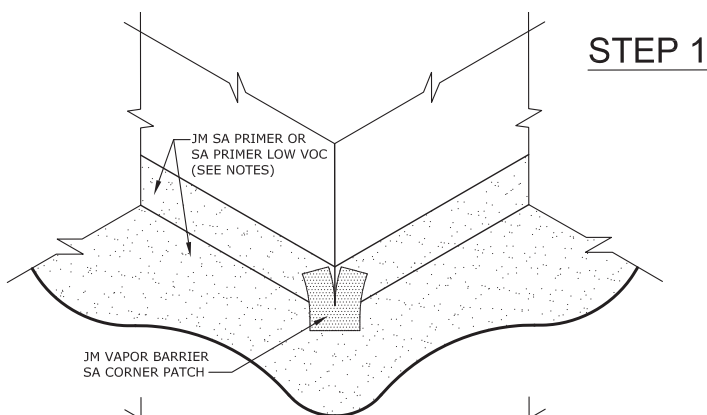

NOTES

1. USE DETAIL IN CONJUNCTION WITH THE STANDARD CURB DETAIL FOR APPROVED ROOF SYSTEM.
2. REFER TO JM VAPOR BARRIER AND PRIMER INSTALLATION INSTRUCTIONS FOR GENERAL GUIDELINES REGARDING THESE SYSTEMS.
3. FOR STEEL DECK SYSTEMS IT IS REQUIRED TO HAVE A MINIMUM OF 1/2" THERMAL BARRIER FASTENED TO STEEL DECK BEFORE JM VAPOR BARRIER IS ADHERED.

Johns Manville is a manufacturer of commercial roofing products and offers this general conceptual information to you as a courtesy. This complimentary assistance is not to be used or relied upon by anyone as a substitute for professional engineering design and documentation required by building code, contract, or applicable law. By accepting these comments you agree they do not constitute any representations, endorsements of, or an assumption by Johns Manville of any liability for either the adequacy of design of this building or any other material not supplied by Johns Manville.

Note: For the most current information on general guidelines, please refer to the System Considerations tab under Commercial Roofing Products on the JM Roofing Web site. For specifications, flashing details and general installation information please refer to the Application Tools tab.

Refer to the Safe Use Instructions and product label prior to using this product.



JM Vapor Barrier SA - Inside Curb Detail

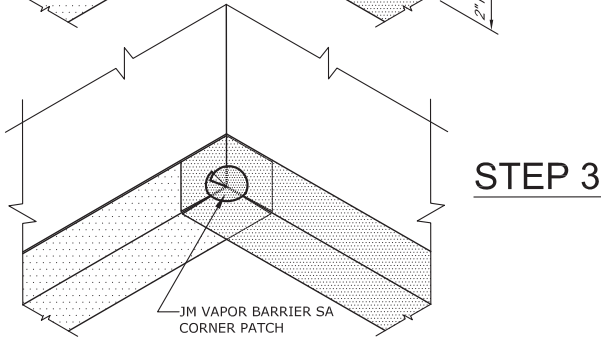
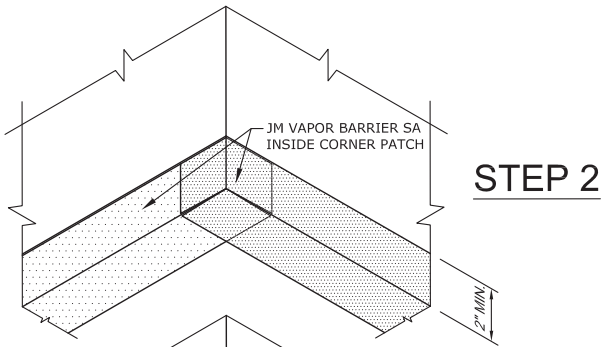
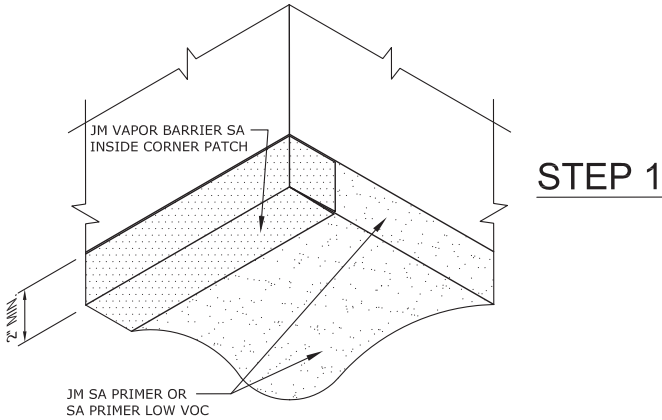

NOTES

1. USE DETAIL IN CONJUNCTION WITH THE STANDARD CURB DETAIL FOR APPROVED ROOF SYSTEM.
2. REFER TO JM VAPOR BARRIER AND PRIMER INSTALLATION INSTRUCTIONS FOR GENERAL GUIDELINES REGARDING THESE SYSTEMS.
3. FOR STEEL DECK SYSTEMS IT IS REQUIRED TO HAVE A MINIMUM OF 1/2" THERMAL BARRIER FASTENED TO STEEL DECK BEFORE JM VAPOR BARRIER IS ADHERED.

Johns Manville is a manufacturer of commercial roofing products and offers this general conceptual information to you as a courtesy. This complimentary assistance is not to be used or relied upon by anyone as a substitute for professional engineering design and documentation required by building code, contract, or applicable law. By accepting these comments you agree they do not constitute any representations, endorsements of, or an assumption by Johns Manville of any liability for either the adequacy of design of this building or any other material not supplied by Johns Manville.

Note: For the most current information on general guidelines, please refer to the System Considerations tab under Commercial Roofing Products on the JM Roofing Web site. For specifications, flashing details and general installation information please refer to the Application Tools tab.

Refer to the Safe Use Instructions and product label prior to using this product.

PEAK *Johns Manville* ADVANTAGE

One manufacturer, one full-system guarantee

Johns Manville offers one of the most comprehensive guarantees in the roofing industry. That's the advantage you can expect from a longtime, dependable leader with the financial backing of Berkshire Hathaway.



facebook.com/JohnsManville



[@JMRoofingSystem](https://twitter.com/JMRoofingSystem)



[JohnsManvillevideos](https://www.youtube.com/JohnsManvillevideos)



www.jmroofing.news



Johns Manville
A Berkshire Hathaway Company

717 17th St,
Denver, CO 80202
(800) 922-5922

www.jm.com/roofing