



# EARTH SHIELD®

## Waterstops for Chemical, Industrial, & Environmental Applications



All ribbed Earth Shield® Waterstop profiles are available with factory installed brass eyelets. The eyelets provide for a convenient and durable tie-off point for wire tying the waterstop to the steel reinforcement prior to the concrete pour.



Earth Shield® Retrofit Column and Pipe Fitting (part number JP320LC1.XX\* [\*XX is diameter in inches]) is manufactured with a flexible, chemical-resistant polymer and includes all stainless steel anchoring hardware.



Earth Shield® JP636 TPV Ribbed Centerbulb (6" width) is the industry standard, utilized on most jobs for its proven fluid-sealing properties.

See page 4 for more info

See page 14 for more info

Waterstops play a critical role in the integrity of concrete structures. They provide a fluid-tight diaphragm when embedded in, and running through concrete joints. Earth Shield® Thermoplastic Vulcanizate Waterstop (TPV), by J P Specialties, Inc., dramatically expands the scope of conventional waterstop by offering unmatched chemical resistance to a broad spectrum of aggressive chemicals, solvents, and hot petroleum oils. Manufactured NSF-certified, EPA-compliant waterstop profiles are available for new construction and retrofit, as well as the tools and accessories for proper field installation.

J P Specialties, Inc. is the leading manufacturer of chemical resistant waterstop and related concrete accessories. Our NSF 61 certified Earth Shield® line of chemical resistant waterstop is used throughout the world by major engineering firms and project owners for primary and secondary containment applications, as well as industrial wastewater treatment and ozone contactor structures. We invented the technology used to mechanically weld thermoplastic waterstops.

Services offered include free blueprint take-off and shop drawings, on-site welding certification, and individual corrosion resistance certification for the project owner.



Earth Shield® Thermoplastic Vulcanizate Waterstop is used as a fluid-tight diaphragm, embedded in concrete, across and along the joint, for primary and secondary containment structures. Earth Shield® TPV Chemical Resistant Waterstops are resistant to a wide range of oils, solvents, and aggressive chemicals. Alcohol, ketones, glycols, esters, and aqueous solutions



of acids, salts, and bases have little effect on Earth Shield® Thermoplastic Vulcanizate Waterstop.



Unlike polyvinyl chloride (PVC) waterstop, Earth Shield® TPV Waterstop contains no plasticizer, stabilizer, or filler to leach out when exposed to chemicals, fuels, and aggressive industrial fluids.



Also, unlike PVC waterstop, Earth Shield® can withstand prolonged exposure to high and low temperatures (-78°F to 275°F long term) without detrimental effect.

Earth Shield® TPV Waterstop is NSF Standard 61 Certified for use in drinking water and is a recyclable polymer, so it's good for health and the environment.



The superior chemical resistance of Earth Shield® Thermoplastic Vulcani-

zate Waterstop coupled with the use of a ribbed centerbulb configuration, which is available in a 4, 6, and 9-inch width, providing greater mechanical bonding with the concrete and a barrier against migration of liquid flow around the waterstop. The ribbed centerbulb style also allows for joint movement and may be used in above or below grade applications. Additional shapes are available for retrofit, extreme expansion, stainless steel, and base seal applications.

Earth Shield® has chosen a fully cross-linked TPV as our standard elastomer compound, which provides superior mechanical properties, retention, and chemical resistance. No competitive product is even close to achieving the physical properties of Earth Shield®.

### Earth Shield® Advantages

- Outstanding fluid resistance to a wide range of aqueous-based fluids, oils, and hydrocarbons
- Excellent retention of physical properties at elevated temperatures
- Superior ozone and weather resistance

Install Earth Shield® TPV Waterstop in all concrete joints. Waterstop should be centered in, and run the extent of the joint. All changes of directions should be prefabricated (see Shop Made Fittings), leaving only butt-welding for

## PH SCALE

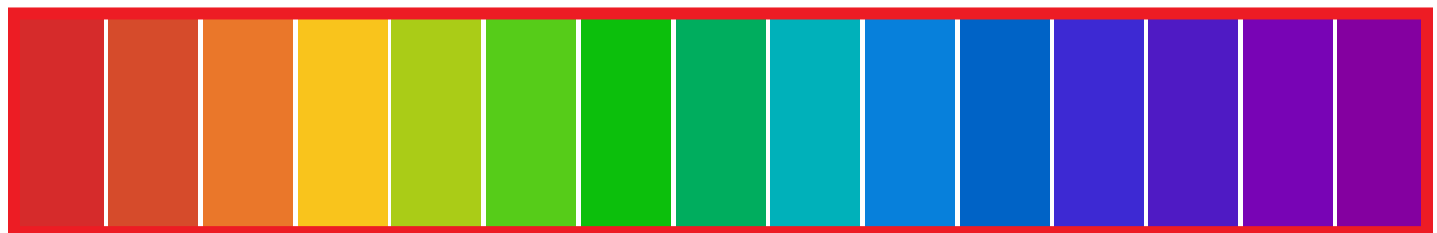

0 1 2 3 4 5 6 7 8 9 10 11 12 13 14  
 ACID ALKALI

the field. If installing in an expansion joint, keep center bulb unembedded to allow it to accommodate movement as designed. Use optional factory installed brass eyelets (or #3 hog rings) and tie wire to secure waterstop to reinforcing steel to avoid displacement during the concrete pour. Splice straight lengths of waterstop and Shop Made Fittings to straight lengths, with an ST-10® In-Line Waterstop Splicer with the iron temperature set to 410°F to 430°F.

More detailed installation instructions are in our Standard 3-part Specifications.

Qualified technical assistance is available during any phase of your construction project.

Standard 3-part Specifications are available at our website in Microsoft® Word and Adobe® PDF format, and upon request in printed and a variety of computer word processor formats. Call our Technical Sales Staff for additional help with your specification.

### TPV Chemical Resistant Waterstop

Waterstop indicated in drawings and specifications for contraction (control), expansion and construction joints shall be Earth Shield® TPV Chemical Resistant Waterstop Part No. ##### [Designer insert appropriate part number here] as manufactured by J P Specialties, Inc.; Murrieta, CA 92562; Phone 951-763-7077

1. Thermoplastic Vulcanizate (TPV) Waterstop shall conform to EPA Title 40 CFR Section 265.193. The suitability of the waterstop for a specific application should be determined by specific testing for that particular requirement per ASTM D471. Project-specific certification to be provided by the manufacturer.
2. Thermoplastic Vulcanizate (TPV) Waterstop shall be independently certified for use in potable water per NSF/ANSI Standard 61. Third-party certified documentation to be provided by the manufacturer.
3. No equals or substitutions allowed.



Property	Test Method	Required Results
Specific Gravity	ASTM D792	.96
Shore A Hardness (5 sec.)	ASTM D2240	90±3 at 25°C (77°F)
Tensile Strength	ASTM D412	2,300 psi
Ultimate Elongation	ASTM D412	530%
100% Modulus	ASTM D746	1,000 psi
Tear Strength	ASTM D624	278 pli at 25°C (77°F)
Compression Set	ASTM D395	29% at 25°C (77°F)
Brittle Point	ASTM D746	-61°C (-78°F)
Drinking Water Safe	NSF/ANSI 61 	Waterstop certified by NSF for use in potable water
Ozone Resistance	ASTM D1171	Passed, no cracking at 600 pphm
Chemical Resistance	ASTM D471	Meet or exceed specific testing standards for contained fluids as required by Owner and certified by Manufacturer
Green Certification	GreenSpec	Approved



## Ribbed Centerbulb for Moving and Non-Moving Joints

**R**ibbed centerbulb is the most versatile type of waterstop available. The centerbulb accommodates lateral, transverse, and shear movement. Ribbed centerbulb waterstops function in expansion, construction, and control joints.

They also provide superior anchoring abilities and a long fluid-flow path because of the multiple ribs on the exterior flanges. Under stress, the many ribs will distort less than a dumbbell type waterstop because the pressure is first applied to the inward-most anchoring rib, and decrease to the subsequent ribs.

The centerbulb allows for joint movement beyond the ultimate elongation of the material, without distorting the anchoring ribs. All of our ribbed centerbulb waterstops have large outer diameter centerbulb. This centerbulb, coupled with the outstanding mechanical properties of our elastomers (ultimate elongation, tensile strength, etc.), provides for unsurpassed joint movement and sealing abilities.

Like all our thermoplastic waterstops, Earth Shield® ribbed centerbulb waterstop can be

heat-welded using a standard waterstop splicing iron, allowing for easy field fabrications and allows the waterstop to function as a continuous, homogeneous, fluid-tight diaphragm. Waterstop directional changes are available along with straight roll stock. Custom, fit-to-print waterstop modules are produced to order. Prefabricated ells, tees, tank pads, column fittings, and many others are in stock and ready to ship.

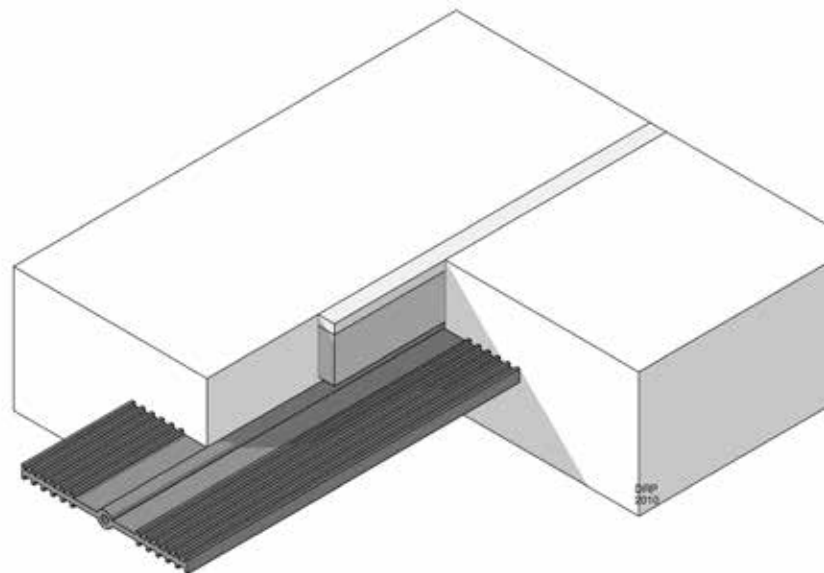

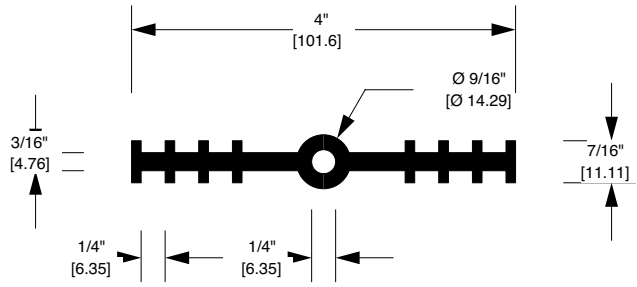

**JP436** (with eyelets: EYJP436)  
**4" Ribbed Centerbulb Waterstop**  
 75 ft Head of H<sub>2</sub>O • 50 lft/roll

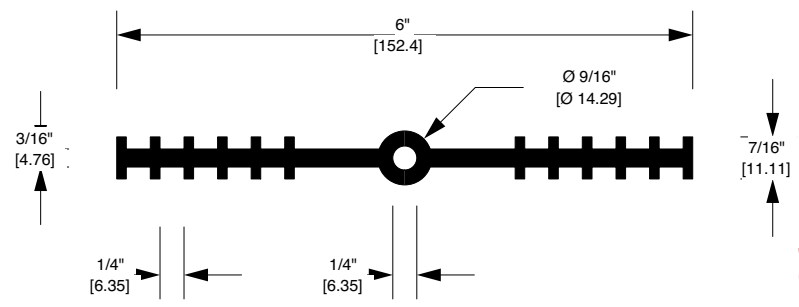

**JP636** (with eyelets: EYJP636)  
**6" Ribbed Centerbulb Waterstop**  
 125 ft Head of H<sub>2</sub>O • 50 lft/roll

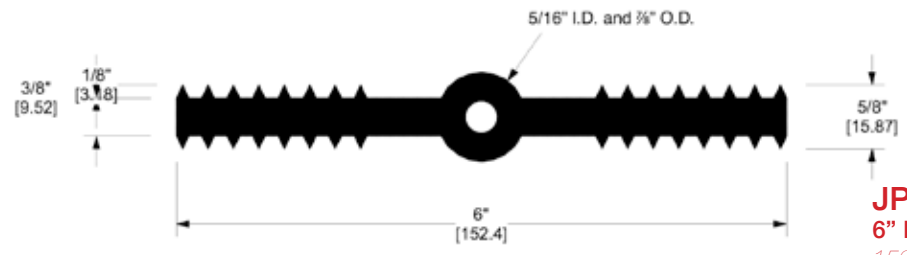

**JP638** (with eyelets: EYJP638)  
**6" Ribbed Centerbulb Waterstop**  
 150 ft Head of H<sub>2</sub>O • 50 lft/roll

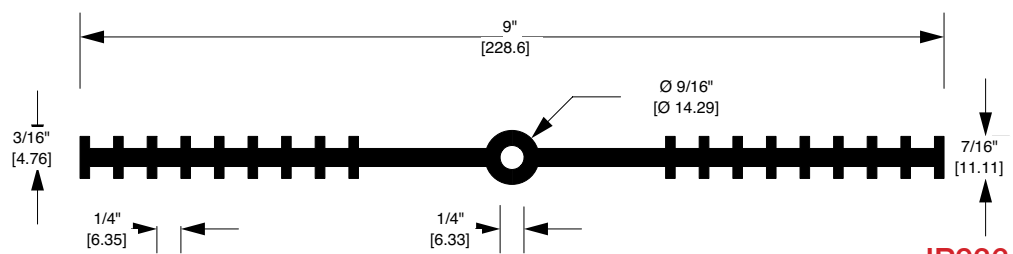

**JP936** (with eyelets: EYJP936)  
**9" Ribbed Centerbulb Waterstop**  
 175 ft Head of H<sub>2</sub>O • 50 lft/roll

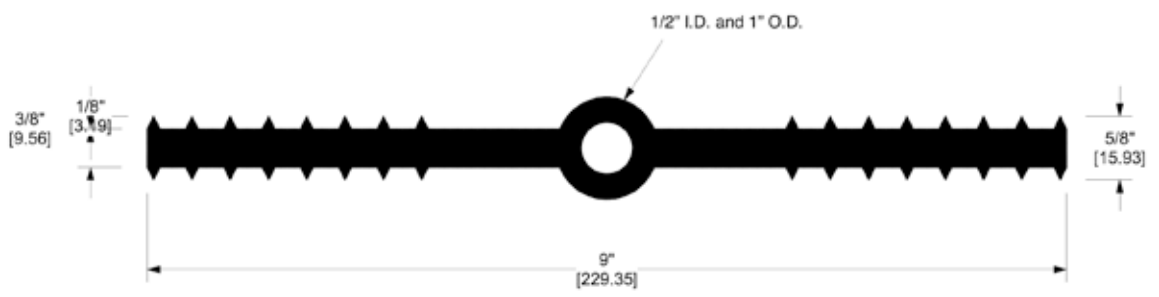

**JP938** (with eyelets: EYJP938)  
**9" Ribbed Centerbulb Waterstop**  
 200 ft Head of H<sub>2</sub>O • 50 lft/roll

# Retrofit Waterstop Systems

## for New to Existing Concrete Joints

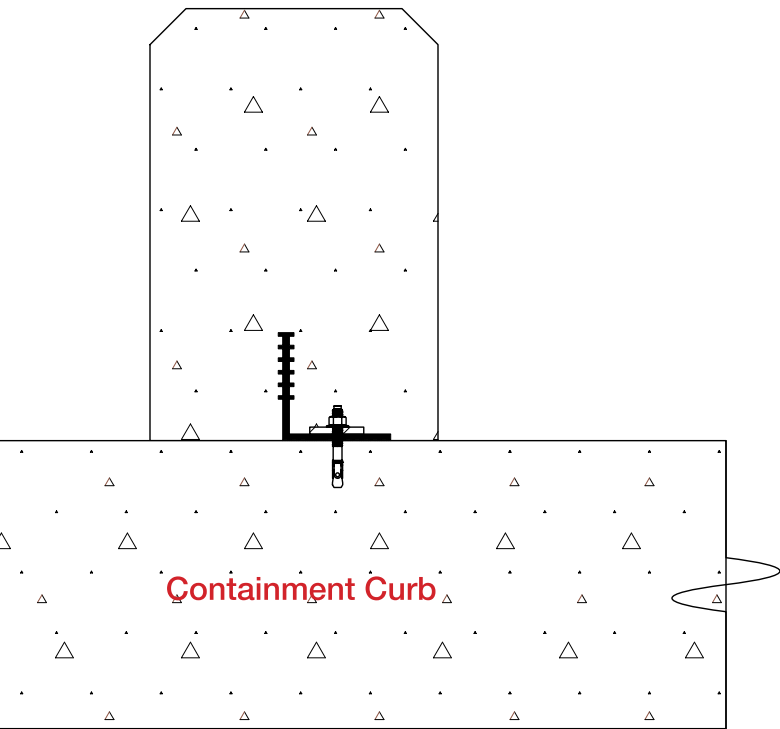

**R**etrofit waterstop is designed to provide a fluid-tight seal between existing and new concrete construction, without resorting to the labor-intensive and structurally destructive saw-cut-and-grout method. It is ideal for constructing a new containment curb or wall to an existing slab or joining a new slab to an existing wall. Special profile fabrications are available for columns and pipe penetrations.

All of our retrofit waterstops are sold as a complete system and include all the necessary stainless steel bars and bolts. We also offer a high-quality chemical resistant novolac epoxy — VEN 1000.

Like all our thermoplastic waterstops, Earth Shield® retrofit waterstop can be heat-welded using a standard waterstop splicing iron, allowing for easy field fabrications, and enable the waterstop to function as a continuous, homogeneous, fluid-

tight diaphragm. Waterstop change of directions can be available along with straight roll stock, and custom, fit-to-print waterstop modules are produced to order. Prefabricated ells, tees, tank pads, column fittings, and many others are in stock and ready to ship.

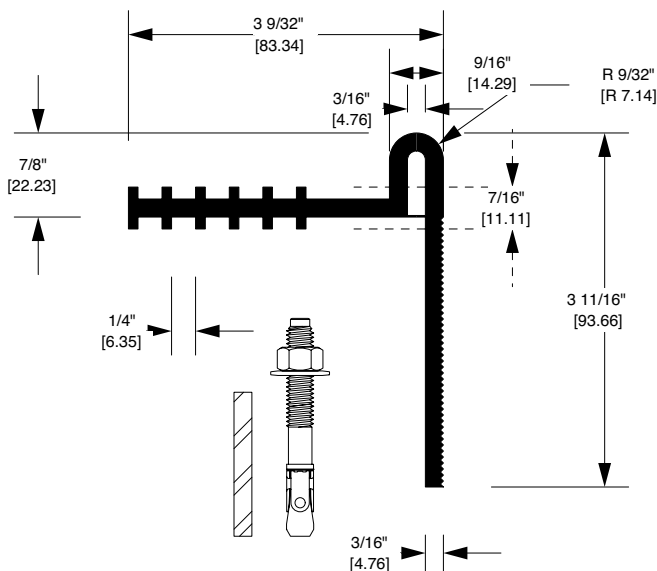

**JP320L** (with eyelets: EYJP320L)  
**Retrofit Waterstop System**  
*(Includes all batten bars and anchors)*  
 125 ft Head of H<sub>2</sub>O • 10 lft/length

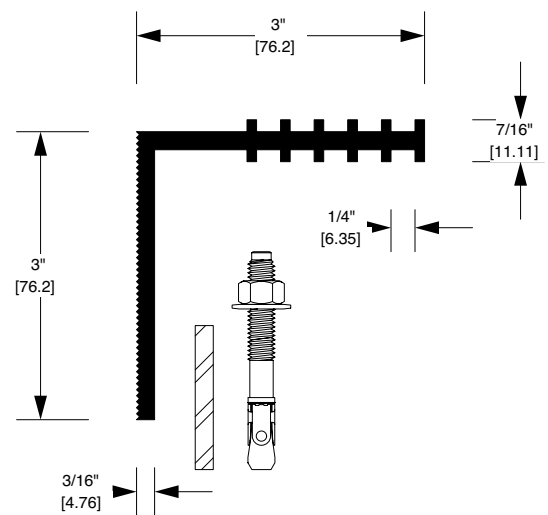

**JP336L** (with eyelets: EYJP336L)  
**Retrofit Waterstop System**  
*(Includes all batten bars and anchors)*  
 125 ft Head of H<sub>2</sub>O • 10 lft/length

**JP540L**

Exterior Applied Corner Retrofit Waterstop  
(Includes all batten bars and anchors)

50 ft Head of H<sub>2</sub>O • 10 lft/length

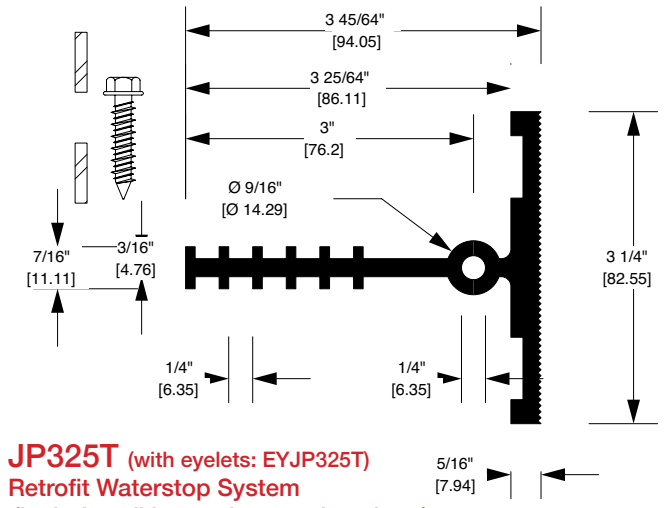
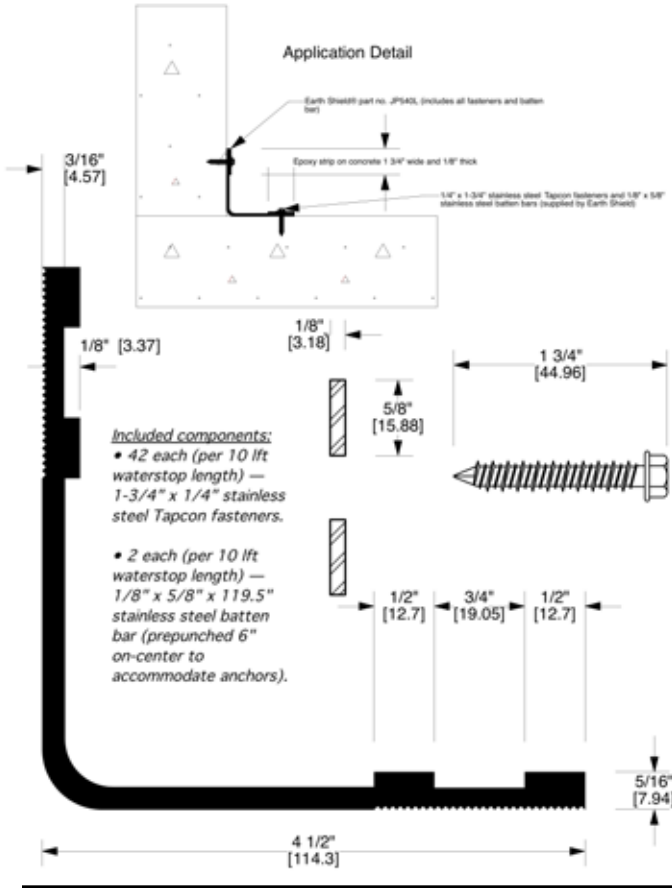

75 ft Head of H<sub>2</sub>O • 10 lft/length

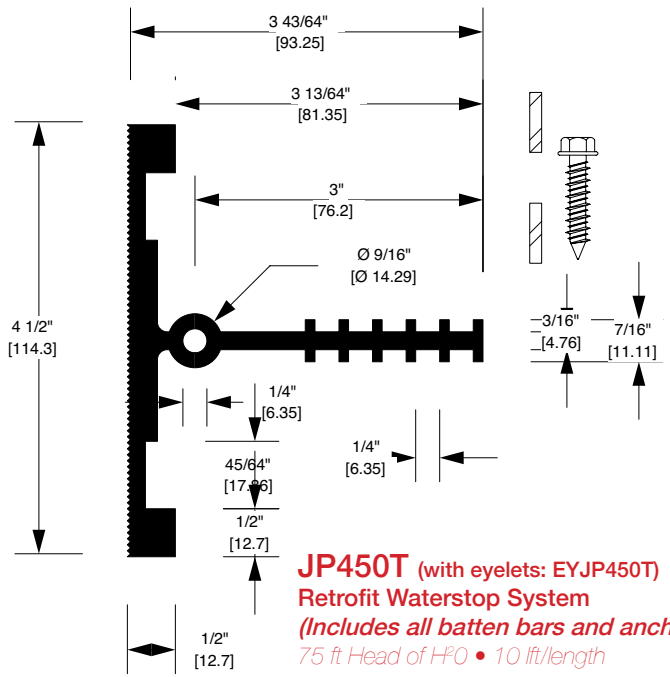

75 ft Head of H<sub>2</sub>O • 10 lft/length

**JP621L**

Large Movement Retrofit  
(Includes all batten bars and anchors)

75 ft Head of H<sub>2</sub>O • 10 lft/length

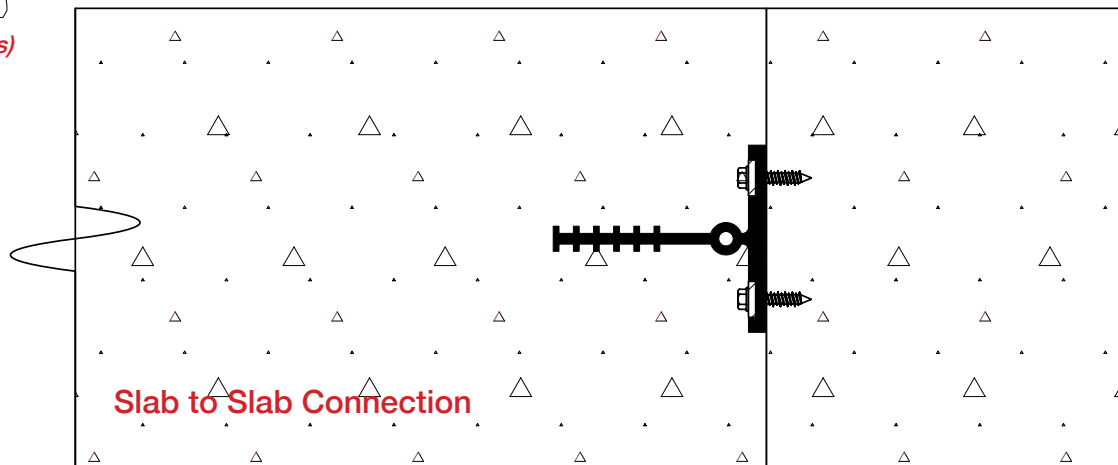
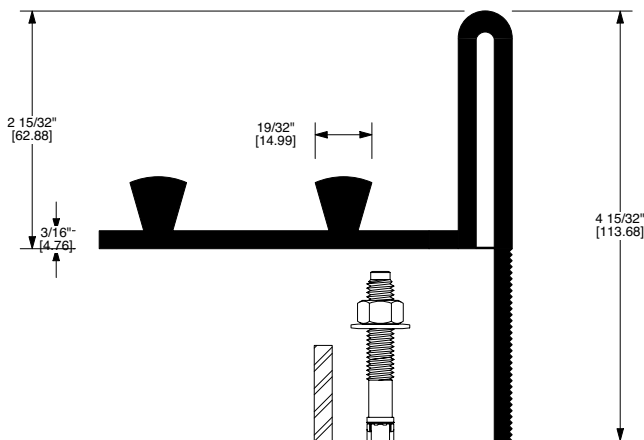

# Integrated Cap Systems

## Integrated Waterstop and Joint Sealant

Integrated expansion board cap waterstop systems are designed to replace post-applied joint sealant, and provide a fluid-tight internal seal like a traditional waterstop with a one-step, integrated unit.

Install Earth Shield® expansion board cap waterstop on top of conventional expansion board filler or Earth Shield's chemical resistant, plastic expansion board. The expansion board acts as the form; therefore, no form splitting is necessary, significantly accelerating the project schedule and provides a long-lasting, attractive finished concrete joint.

- No split forms
- Accelerated installation
- No sawcutting or sealant
- No joint finishing
- Long life
- UV and abrasion resistant

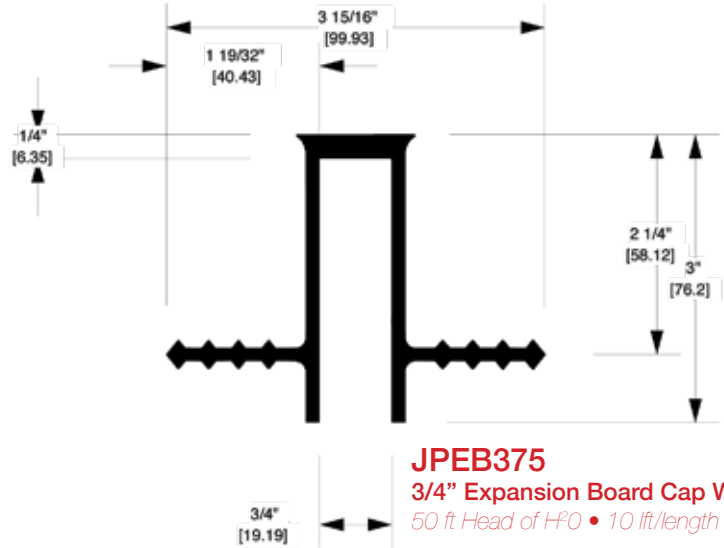

**JPEB375**  
**3/4" Expansion Board Cap Waterstop**  
 50 ft Head of H<sub>2</sub>O • 10 ft/length

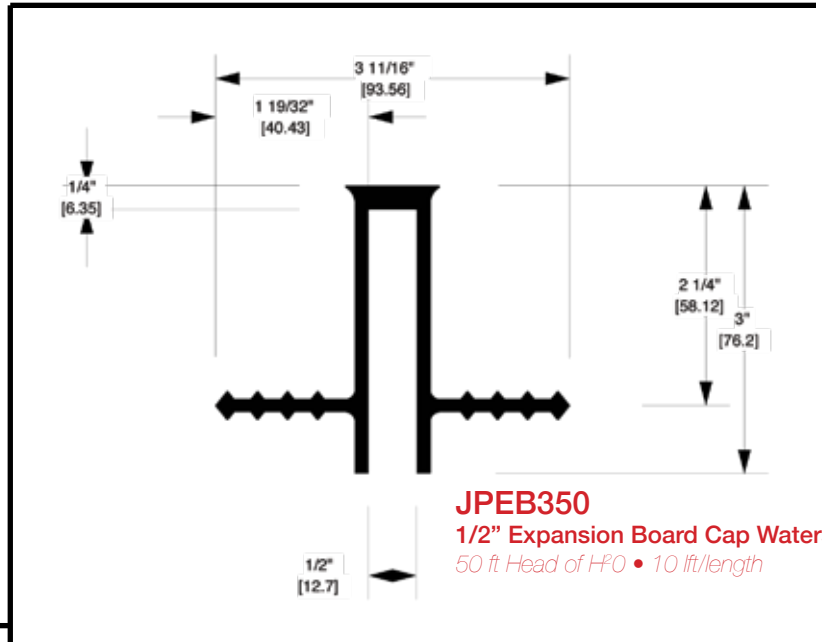

**JPEB350**  
**1/2" Expansion Board Cap Waterstop**  
 50 ft Head of H<sub>2</sub>O • 10 ft/length

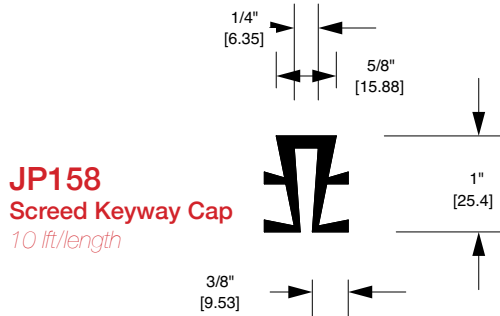

**JP158**  
**Screenshot Keyway Cap**  
 10 ft/length

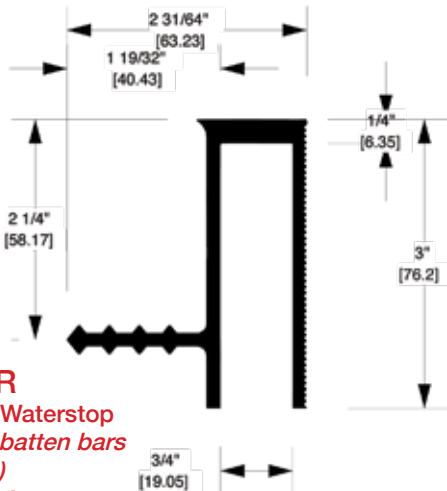

**JPEB375R**  
**Cap Retrofit Waterstop**  
 (Includes all batten bars and anchors)  
 50 ft Head of H<sub>2</sub>O  
 10 ft/length

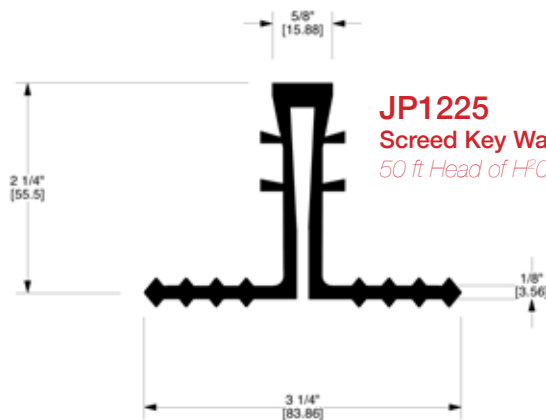

**JP1225**  
**Screenshot Key Waterstop**  
 50 ft Head of H<sub>2</sub>O • 10 ft/length



# Corner Seal

## Unique Problem-Solver, Integrates with Base Seal

Corner seal waterstop systems install on the footer at a slab/wall interface. Earth Shield® corner seal works well with our base seal profile (JP211).

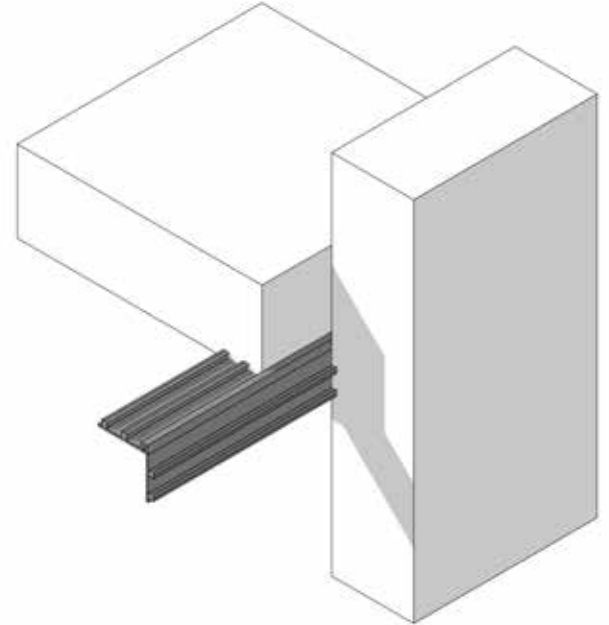
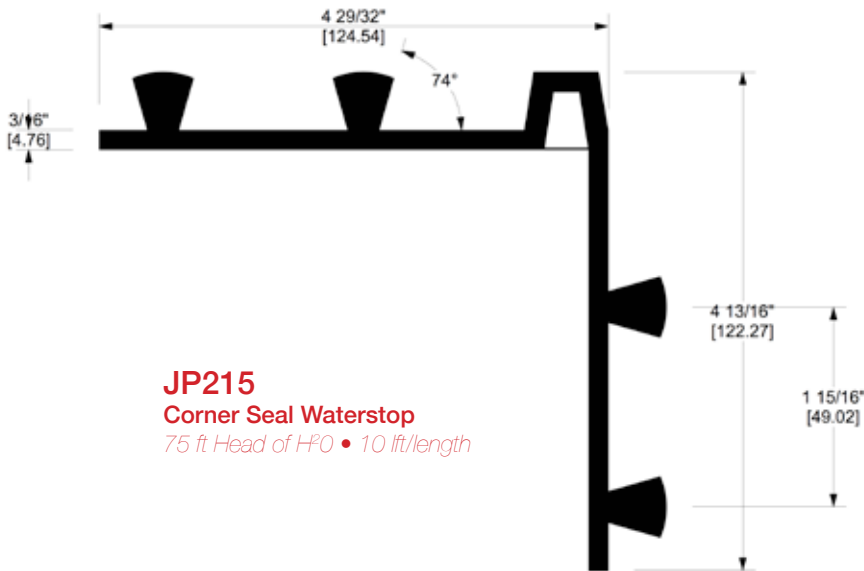

# Flat Strip (aka Ribbed)

## Resists High Head Pressure

Flat strip waterstop is installed most often in below grade applications, with limited movement. Flat strip waterstop functions in construction and contraction (control) joints.

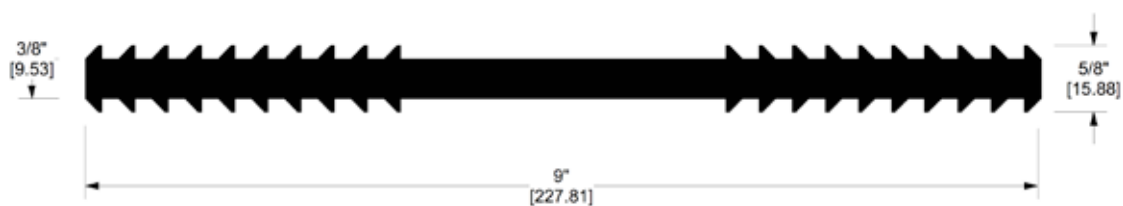
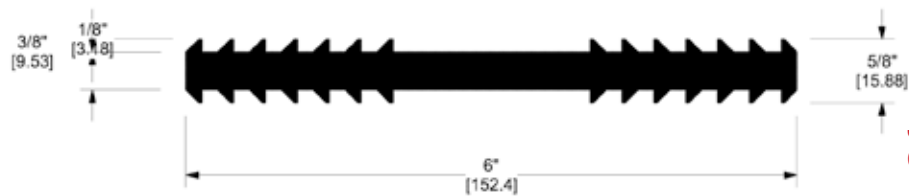

# Made in t

## Waterstop for Che & Environments

Manufactured  
with pride by



J P SPECIALTIES, INC.

# www

# the U.S.A.

J P Specialties, Inc. manufactures a wide range of high-quality waterstop and waterstop accessories for the concrete construction industry. Our Earth Shield® line of chemical resistant waterstop is designed to offer solutions for today's unique regulatory compliance needs. Our waterstop welding equipment is used industry-wide as the standard for quality, high tensile strength waterstop welds. Knowing that a waterstop will only offer a fluid-tight barrier if change of directions are done properly, J P Specialties has been a leader since 1954 in Prefabricated Waterstop Modules and Shop Made Fittings.

## Chemical, Industrial, and Residential Applications

# WWW.EARTHSHIELD.COM

# Special Shapes

## for Large Movement Joints

**E**arth Shield® tear web waterstops are for large joint movements such as tank foundations. Tear web is suitable for expansion joints. For construction and contraction (control) joints, install ribbed centerbulb instead.

**JP678** (with eyelets: EYJP678)  
**6" Tear Web Waterstop**  
 125 ft Head of H<sub>2</sub>O • 50 lft/roll

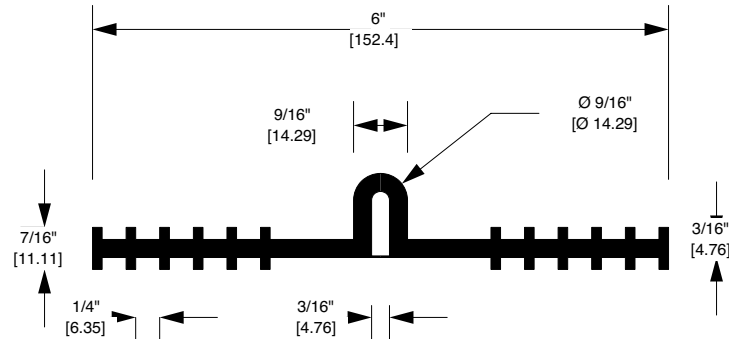

**JP978** (with eyelets: EYJP978)  
**9" Tear Web Waterstop**  
 175 ft Head of H<sub>2</sub>O • 50 lft/roll

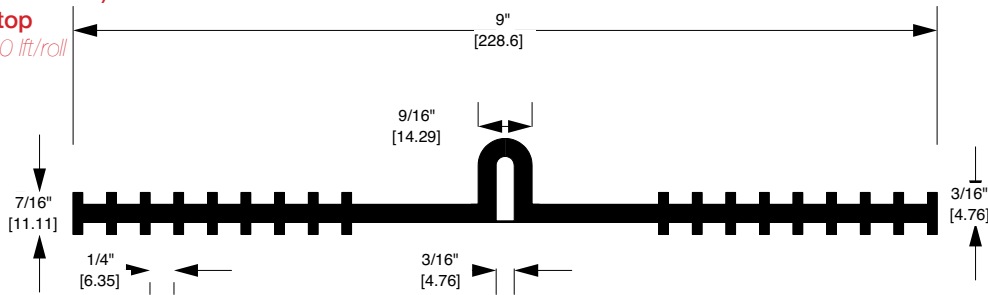

# Base Seal (aka Rearguard)

## for Flatwork and Bund Wall Applications

**B**ase seal waterstop is ideal for flat pavement jobs such as runways and large containment slabs. Base seal waterstop is by far the easiest waterstop to install... Simply lay the waterstop directly on the compacted subgrade, place and finish concrete, and create control joint using a saw cut or another method. The base seal provides a permanent, life-of-structure seal at the bottom of the joint. Base seal is suitable for construction, contraction (control), and expansion joints. For sizeable hydrostatic head pressures (>50 foot) ribbed centerbulb should be used instead.

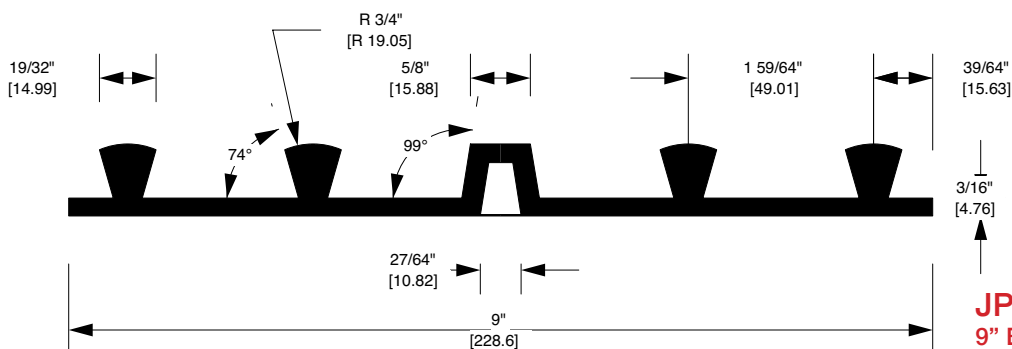

**JP211**  
**9" Base Seal Waterstop**  
 75 ft Head of H<sub>2</sub>O • 50 lft/roll

# Dumbbell

## Large Web Thickness for Heavy Concrete

**D**umbbell waterstop is installed most often in below grade applications, with limited movement. Dumbbell waterstop works well in construction and contraction (control) joints; whereas, dumbbell centerbulb accommodates construction, control, and expansion joints.

The large centerbulb (1-1/2" outer diameter) on the JP949 (and JP1149) waterstop profile, coupled with the outstanding mechanical properties of our thermoplastic elastomers and large endbulb anchors, enable the product to withstand large-scale joint movement (seismic or settlement).

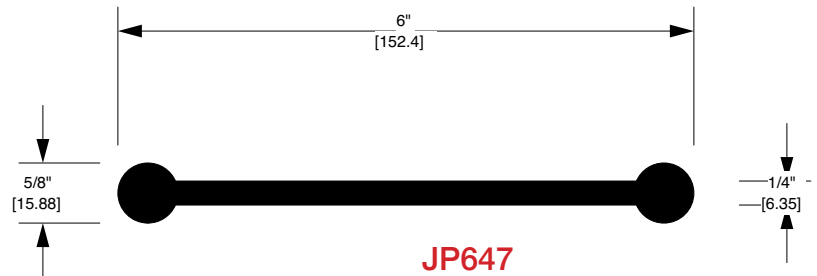

**JP647**  
**6" Dumbbell Waterstop**  
 125 ft Head of H<sub>2</sub>O • 50 lft/roll

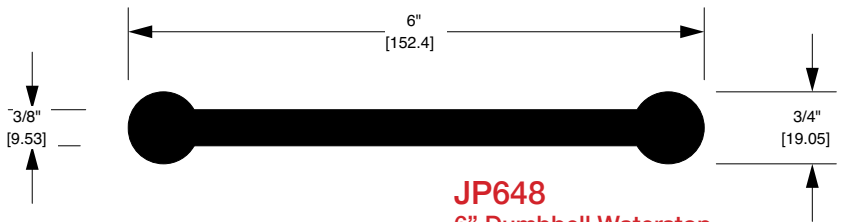

**JP648**  
**6" Dumbbell Waterstop**  
 125 ft Head of H<sub>2</sub>O • 50 lft/roll

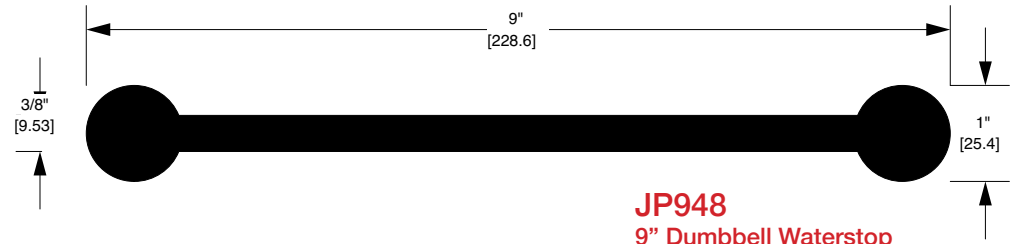

**JP948**  
**9" Dumbbell Waterstop**  
 150 ft Head of H<sub>2</sub>O • 50 lft/roll

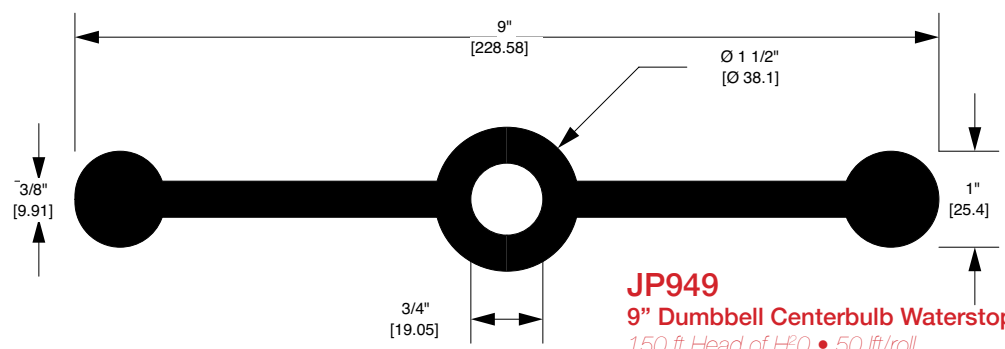

**JP949**  
**9" Dumbbell Centerbulb Waterstop**  
 150 ft Head of H<sub>2</sub>O • 50 lft/roll

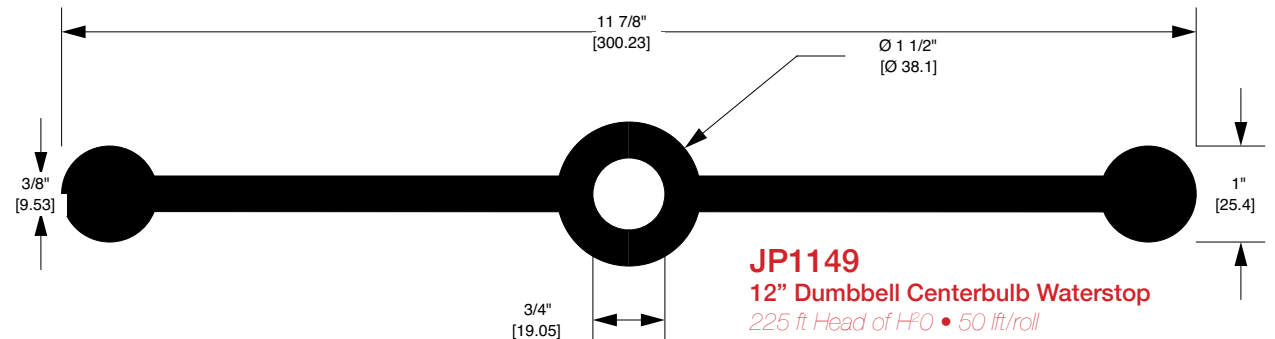

**JP1149**  
**12" Dumbbell Centerbulb Waterstop**  
 225 ft Head of H<sub>2</sub>O • 50 lft/roll

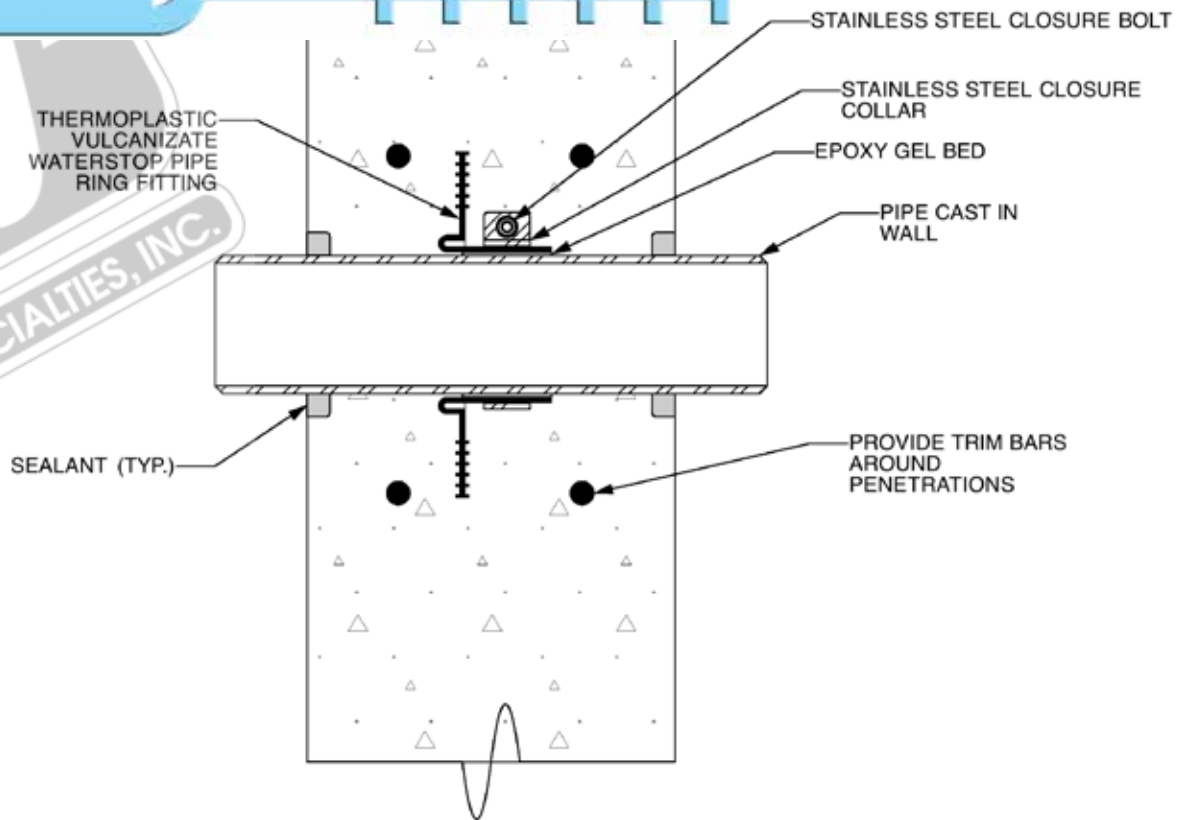

<b>JP Specialties, Inc. / Earth Shield®</b>		
551 Birch Street • Lake Elsinore, CA 92530 • <a href="http://www.jp-specialties.com">www.jp-specialties.com</a> phone 800-821-3859 • international 951-674-6869 • fax 951-674-1315		
TITLE <i>Waterstop Pipe Fitting</i>		
PART NUMBER <b>JP320LC1</b>	DRAWN BY <i>DRP</i>	DATE <i>11/09</i>
CAD FILE NAME ACI350_2R_Waterstop_Collar	APPROVALS	SIZE <b>A</b>

## Retrofit Column and Pipe Fitting

**E**arth Shield® has solved a long-standing problem for engineered concrete structures with circular protrusions, such as columns, pipes, piers, and pilasters. The problem: how to permanently seal the concrete joint when cast-in-place concrete is formed against an existing circular member. The solution: Earth Shield® Column & Pipe Fitting (part no. JP320LC1.XX\* [\*XX is the diameter in inches]) manufactured with a flexible, chemical-resistant polymer and stainless steel anchoring hardware. A single laborer on the job site can quickly install the column fitting and its associated hardware. Just apply an epoxy gel bed to the existing surface; place the polymer ring into the epoxy gel bed; heat weld the single opening on the polymer ring using a waterstop splicing iron; and finally, complete the system with the stainless steel closure ring.



The Earth Shield® system functions as an internal dam, centrally located within the cast concrete, to stop aggressive chemicals, solvents, and hot petroleum oils from penetrating the joint. By preventing the passage of hazardous liquids, the Earth Shield® Column Fitting provides facility owners, engineers, and contractors with the necessary EPA-mandated containment compliance (EPA Title 40 CFR 265.193). Of course, the system prevents the passage of water as well. The mechanical properties of the polymer, plus the tear-web design of the JP320L profile, enable the column fitting to function equally well in expansion (isolation) joints and construction joints.

# Standard Fabrications



JP436L1 Flat EII  
JP636L1 Flat EII  
JP936L1 Flat EII



JP436T1 Flat Tee  
JP636T1 Flat Tee  
JP936T1 Flat Tee



JP436X1 Flat Cross  
JP636X1 Flat Cross  
JP936X1 Flat Cross



JP436L2 Vert EII  
JP636L2 Vert EII  
JP936L2 Vert EII



JP436T2 Vert Tee  
JP636T2 Vert Tee  
JP936T2 Vert Tee



JP436X2 Vert Cross  
JP636X2 Vert Cross  
JP936X2 Vert Cross



JPEB350X1 Flat Cross  
JPEB375X1 Flat Cross  
JP1225X1 Flat Cross



JPEB350T1 Flat Tee  
JPEB375T1 Flat Tee  
JP1225T1 Flat Tee



JPEB350L1 Flat EII  
JPEB375L1 Flat EII  
JP1225L1 Flat EII



JPEB350L2 Inside Corner  
JPEB375L2 Inside Corner  
JP1225L2 Inside Corner



JPEB350L3 Outside Corner  
JPEB375L3 Outside Corner  
JP1225L3 Outside Corner

*Many other  
standard fittings  
are available*



J P SPECIALTIES, INC.

**Base/Corner Seal**

- JP211
- JP621L
- JP215

**Flat Strip**

- JP637
- JP937

**Retrofit**

- JP320L
- JP325T
- JP336L
- JP450T
- JP500
- JP540L
- JP621L
- JPEB375R

**Ribbed Centerbulb**

- JP436
- JP636
- JP638
- JP936
- JP938

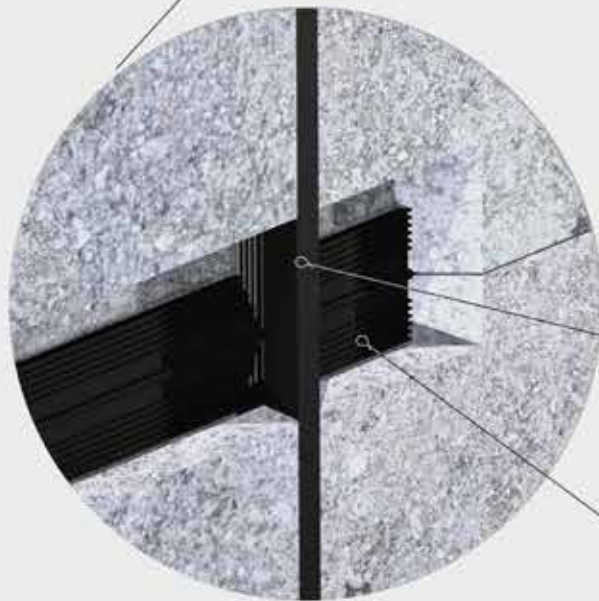

[EXPANSION JOINT]

**JP636**  
[6" RCB TPV WATERSTOP]

[9" BASE]



# TYPICAL TRENCH EXPANSION JOINT



**JPEB375**  
[EPOXY RESIN WATERSTOP]

**JP211**  
[SEAL TPV WATERSTOP]

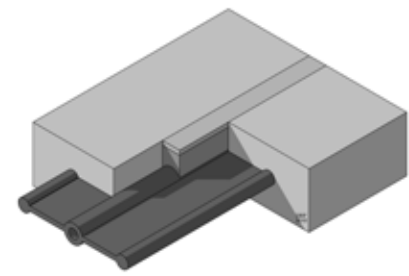

**Dumbbell**  
JP647  
JP648  
JP948  
JP949  
JP1149

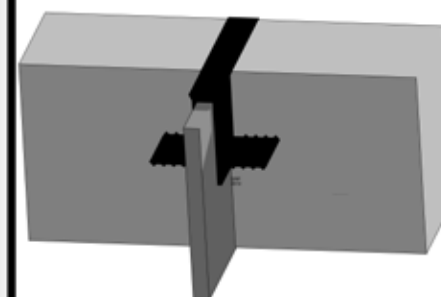

**Integrated Cap**  
JP158  
JPEB350  
JPEB375  
JPEB375R  
JP1225

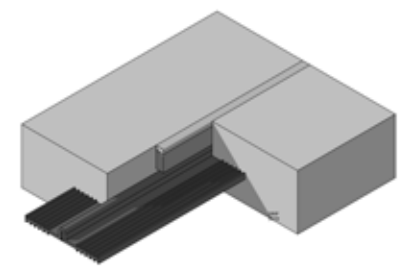

**Tear Web**  
JP678  
JP978

# Waterstop Shop Made Fittings

## Ensure A Quality, Leak-Proof Project

Shop Made Fittings are recognized and specified worldwide by major engineering firms. The U.S. Army Corps of Engineers also specified Shop Made Fittings in the July 1995 revision of CEGS Section 03250. Shop Made Fittings are specified because they work. Edge-welding waterstop severely compromises the integrity of any project. Even the limited movement of concrete during the coefficient of expansion and contraction can be too much for edge welded waterstop. The edge welded waterstop lacks the proper tensile strength and does not maintain the characteristics of the parent material (bulb or rib continuity). Consequently, the waterstop often tears at the most critical junction: the change of direction. Since all waterstops are designed to act as a continuous, fluid-tight diaphragm which fluids (generally water) traverse, the structure that uses edge welded waterstop will naturally leak, as fluids migrate to any tears in the weld and pass through to the other side of the joint.

Structures that use Shop Made Fittings will significantly reduce these waterstop failures. The tensile strength of the weld will be at least 80% of the parent material, maintaining the continuity of the bulbs and ribs across the weld. In other words, the waterstop will perform as intended and last the life of the structure.

J P Specialties has an extensive library of CAD drawings that illustrate the many uses of various Shop Made Fittings and explain waterstop's role in creating a fluid-tight structure.

J P Specialties certified welding crew efficiently manufactures large quantities of top-quality Shop Made Fittings with speed on our exclusive XLT-2000 Waterstop Splicing Tables. Therefore, we can pass the savings on to the end user: the contractor. Besides saving money, the contractor who uses Shop Made Fittings will save time. A standard flat cross has twelve cuts and seven welds. By using Shop Made Fittings, all of the cuts and three of the welds are eliminated. The number of welds is further reduced by using modules.





NSF/ANSI Standard 61 was developed to establish minimum requirements for the chemical contaminants and impurities imparted to drinking water from products, components, and materials used in drinking water systems.

Standard 61 is intended to cover specific materials or products that come into contact with drinking water, drinking water treatment chemicals, or both. The focus of Standard 61 is the evaluation of contaminants or impurities imparted indirectly to drinking water.

In the U.S., 47 of 50 states have legislation that requires compliance with NSF/ANSI Standard 61. Products that are NSF Certified against NSF/ANSI Standard 61 demonstrate compliance with both Canadian and U.S. Plumbing Codes. NSF Certification and Testing are widely accepted. NSF data is recognized by ASSE, BOCA, IAPMO, ICBO-ES, SBCCI, the City of Los Angeles and many others.

# Trust Your Critical Water Projects to Earth Shield® — NSF Standard 61 Certified, EPA Compliant Waterstop

Water is arguably the most valuable resource in the world. Today's water treatment, distribution, and storage projects are under ever-increasing layers of regulations and requirements, the foremost being that components and materials that contact potable water not have potential adverse human effects.

Earth Shield® TPV Waterstop, with NSF 61 certification, is the perfect choice for today's critical water projects, and in particular drinking water projects.

Page 1 of 2  
Issue Date 1-OCT-03

**NSF International (NSF)**  
DRINKING WATER ADDITIVES AUTHORIZED REGISTERED FORMULATION  
AUTHORIZED REGISTERED FORMULATION - STANDARD 61  
TOXICOLOGY INFORMATION SHEET

REVISED Revised function and listing footnote

DCC: IA12497  
Verified By: Jennifer Duhan (1455)

Corp. No. 1D630  
Plant No. 1D631

Company Name JP SPECIALTIES, INC. / EARTH SHIELD WATER  
Plant Address 551 BIRCH STREET  
LAKE ELSINORE CA 92530

Category: JOINING AND SEALING MATERIALS  
Function: Waterstop

Trade Designation  
Earth Shield Waterstop  
JP158  
JP211  
JP320L  
JP336L  
JP325T  
JP450T  
JP436  
JP636  
JP647  
JP936  
JP949  
JP678  
JP1149  
JP948  
JP648

Water Contact Temp. CLD 23  
Water Contact Material and Code TPE

Listing Footnotes:  
This material is approved as a waterstop for use in any potable water treatment or retaining structure.

Size

**NSF Certified Waterstop**  
Independently Tested by NSF International

# Availability

## National and International Warehouses

Earth Shield® Chemical Resistant Waterstop is readily available from a variety of sources:

- **Preferred Regional Stocking Partners** — *We are partners with some of the very best Concrete Accessories Distributors in the world. All our preferred partners have large stocking inventories and are factory trained to provide the utmost in on-site assistance.*
- **Distributor Sales** — *Earth Shield® can be special ordered from many distributor sales channels throughout the world.*
- **Factory Direct** — *Earth Shield® may be contacted directly for project quotation and product purchase (call 800-821-3859).*

# Services

- **Project and Product Certification** — *We assist the Design Engineer and Project Owner with individual project and product certification. When you specify our waterstop, you can be assured it is the correct product for your application.*
- **Take-off Assistance** — *For the Contractor.*
- **Shop Drawings** — *3-D isometric and 2-D CAD details are available to assist the project.*
- **On-site waterstop welding certification class** — *\$500.00 flat fee*
- **On-site waterstop installation assistance** — *\$1,000.00 per day*
- **Telephone and Web-based assistance** — *Always FREE*

Distributed by:



Visit Earth Shield® on the web at  
**[www.jpsspecialties.com](http://www.jpsspecialties.com)**

## Earth Shield® Waterstop Limited Warranty

J P Specialties, Inc. warrants to the Buyer that this product is new and will be free from defects and will perform as represented in writing subject to the two (2) following conditions: First, the application of the product and the concrete construction practices used in the application are in accordance with J P Specialties, Inc. recommendations; and, Second, the Buyer has selected the proper product for the specific application required.

Any information supplied in good faith by J P Specialties, Inc. with respect to its products is believed to be correct. J P Specialties, Inc. Makes no representation or warranties, expressed or implied, as to the accuracy or completeness of such information.

The exclusive remedies of the Buyer and the limit of the liability of J P Specialties, Inc. from any and all losses or damages resulting from the use of this product shall be either full refund of the purchase price to the Buyer of this product or the replacement of the quantity of product purchased by the Buyer at the discretion of J P Specialties, Inc.

All supplied testing data has been performed by independent testing laboratories.

J P Specialties, Inc.  
Phone: 800-821-3859; 951-763-7077  
Fax: 951-386-0160  
**[www.jpsspecialties.com](http://www.jpsspecialties.com)**



 [www.facebook.com/waterstop](https://www.facebook.com/waterstop)