



Product Description

MarinoWARE® FAS-093X-V is an extruded flexible PVC control joint with an integrated intumescent strip that provides fire, smoke, and sound rated solutions in vertical control joints.

- ✔ Can be used in INTERIOR drywall partitions.
- ✔ Has integrated mud legs for attachment and adhesion of joint compounds.
- ✔ Provides an aesthetically pleasing reveal with integrated groove.
- ✔ Installs fully cured, unaffected by water/moisture/temperature.
- ✔ Easily installs using spray adhesive and staples.
- ✔ Pink in color for identification in the inspection process.
- ✔ Does not require drywall rips, fire sealant or mineral wool backing within the wall cavity.
- ✔ Tear away mud guide strip to protect the v-groove during installation.
- ✔ Can be used in metal or wood stud wall assemblies.
- ✔ Provides 1 and 2 hour fire rating from the same profile.
- ✔ Paintable.

Ordering / Packaging

Description	Part #	Length	Pcs/Ctn	Submitted for Review/Use	✔
FAS-093X-V	093XV	10'	20	093X-V	

Storage / Warranty

- ✔ When stored indoors and kept dry in the original package, Sound Gasket will provide unlimited shelf life.
- ✔ See Firestop Product Warranty for details.

ASTM & Code Standards

- ✔ ASTM C1047-99
- ✔ ASTM D1784-03
- ✔ ASTM D3678-97
- ✔ ASTM E84
- ✔ ASTM E1966
- ✔ UL 2079 5th Edition
- ✔ L-Rating (air leakage) testing for compliance with International Building Code (IBC) and Canadian Building Code (CBC).
- ✔ UL listings/approvals include: HW-D-0596; HW-D-0621; WW-D-0172
- ✔ **U.S. Patent No. 8,671,632**



Always check UL Fire resistance directory for complete design requirements.

For more information, please contact MarinoWARE® Technical Services at 866.545.1545

This technical information reflects the most current information available and supersedes any and all previous publications effective July 18, 2025 | MW_Firestop_Catalog | ©WARE Industries, Inc. 2025

FAS®-093X™-V (VINYL) FIRE RATED CONTROL JOINT

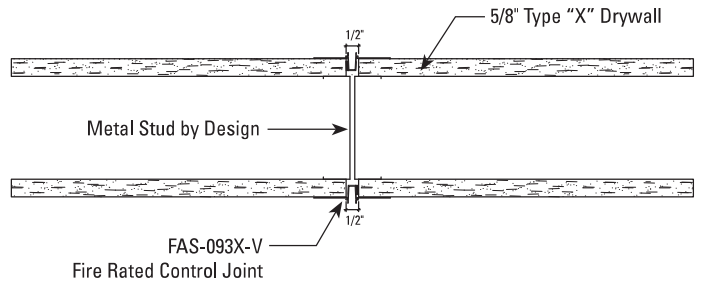
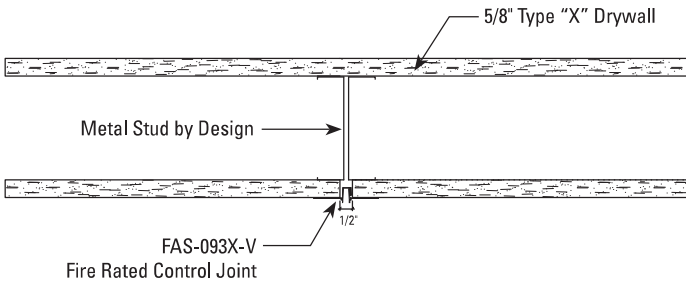
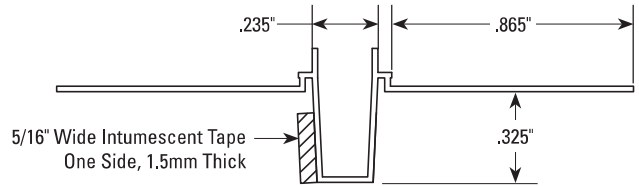
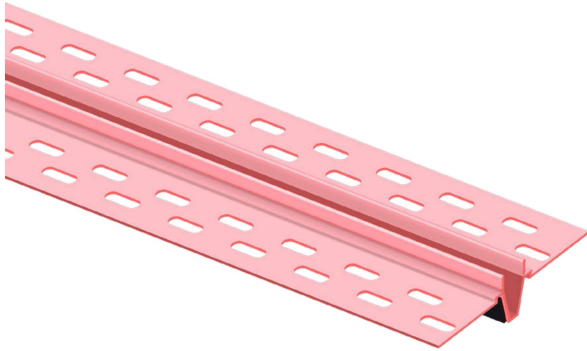

UL Systems available allowing installation on both or one-side of wall assembly. Consult UL System for details.



← View the installation video!

Always check UL Fire resistance directory for complete design requirements.

For more information, please contact MarinoWARE® Technical Services at 866.545.1545

This technical information reflects the most current information available and supersedes any and all previous publications effective

July 18, 2025 | MW_Firestop_Catalog | ©WARE Industries, Inc. 2025

HW-D-0621 2HR SHAFT WALL CONCRETE SLAB BYPASS

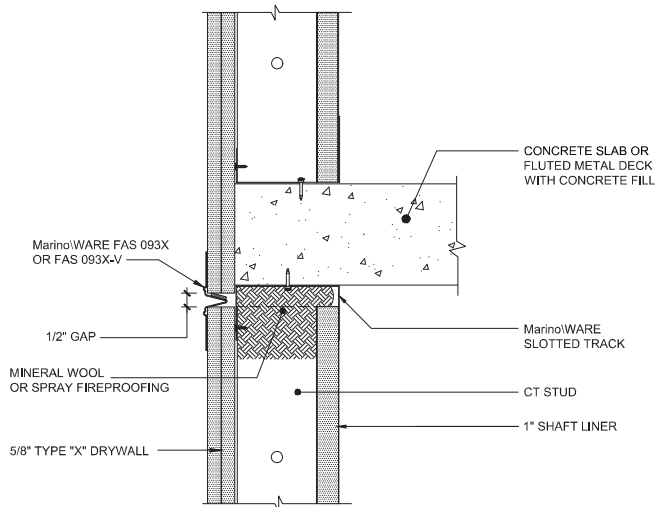

*NOTE: SINGLE LAYER OF 5/8" TYPE "X" DRYWALL FOR 1 HOUR FIRE RATING, 2 LAYERS FOR 2 HOUR

HW-D-0596 2HR STANDARD WALL @ CONCRETE STAIRWELL SLAB BYPASS

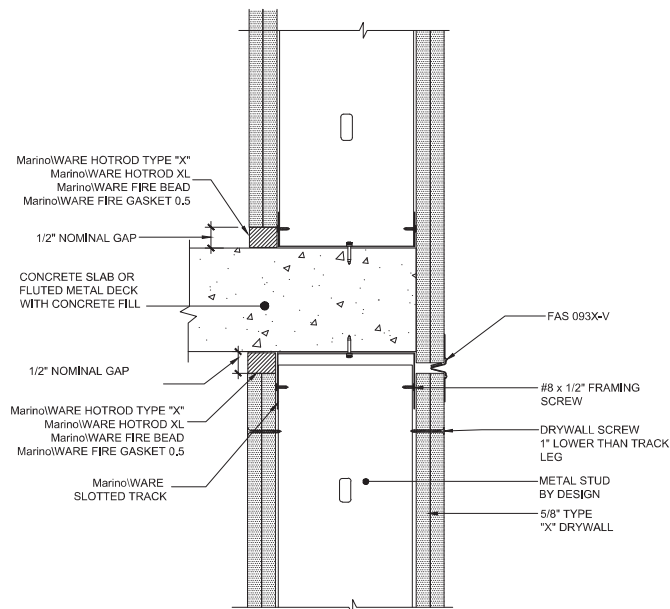

*NOTE: SINGLE LAYER OF 5/8" TYPE "X" DRYWALL FOR 1 HOUR FIRE RATING, 2 LAYERS FOR 2 HOUR

WW-D-0172 2HR VERTICAL JOINT FAS 093X

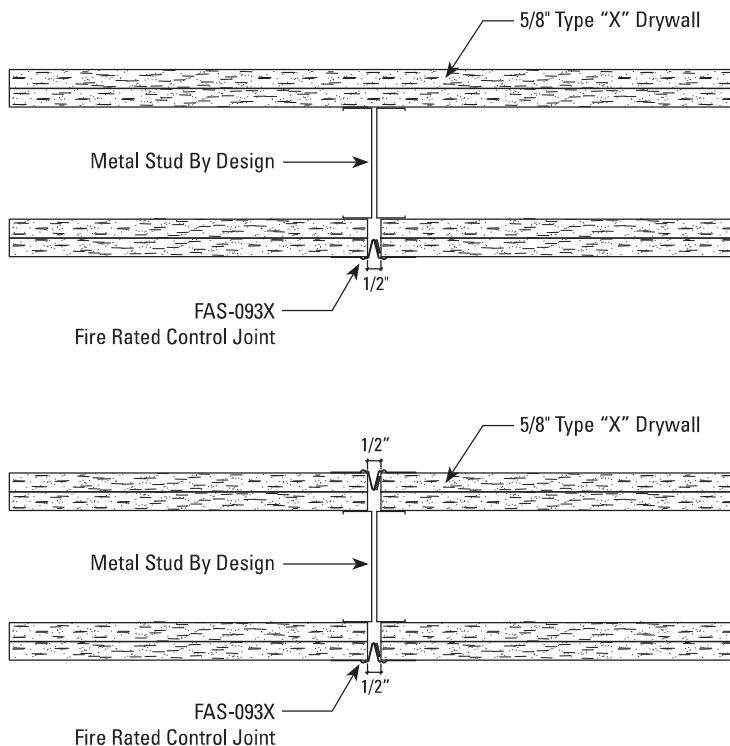

*NOTE: SINGLE LAYER OF 5/8" TYPE "X" DRYWALL FOR 1 HOUR FIRE RATING, 2 LAYERS FOR 2 HOUR

Always check UL Fire resistance directory for complete design requirements.

For more information, please contact MarinoWARE® Technical Services at 866.545.1545

This technical information reflects the most current information available and supersedes any and all previous publications effective July 18, 2025 | MW_Firestop_Catalog | ©WARE Industries, Inc. 2025