

# Marino\WARE® Product Submittal Data

**PRODUCT NAME:** FAS TRACK 1000 Deep Leg - Fire, Air & Smoke Protection

**Nomenclature:** 400FTDL200-43

## PROPERTIES:

<b>A. Web (in)</b>	4	<b>Yield Strength Fy (KSI)</b>	33
<b>Flange (in)</b>	2	<b>Design Thickness (in)</b>	0.0451
<b>Mils</b>	43	<b>Minimum Thickness (in)</b>	0.0428
<b>Finish</b>	G60	<b>Gauge</b>	18

## FIRE RATED DESIGNS (UL 2079):

HW-D-0514	HW-D-0553
HW-D-0518	HW-D-0573
HW-D-0524	HW-D-0620
HW-D-0550	HW-D-0624
HW-D-0551	HW-D-0652

## CODES & STANDARDS

- IBC 2015, 2012
- Steel and coating meets ASTM A1003

## GREEN INFO

- LEED v3 & LEED v4 credits available
- Contact Technical Services for more information

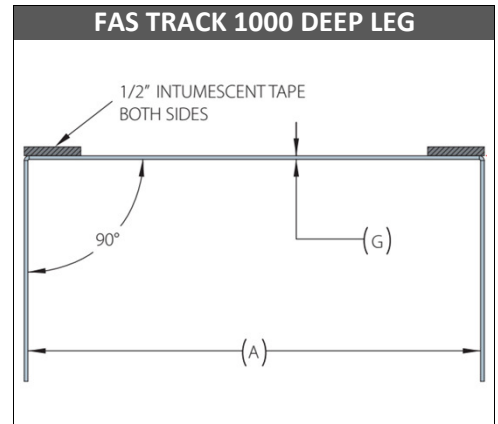

For more information, please contact Marino\WARE Technical Services at 866-545-1545.

This technical information reflects the most current information available and supersedes any and all publications, effective 4/1/2016

©Copyright 2016 by Ware Industries, Inc. All rights reserved