

Marino\WARE® Product Submittal Data

PRODUCT NAME: FAS TRACK 1000 SLOTTED - Fire, Air & Smoke Protection

Nomenclature: 600FT275-54

PROPERTIES:

A. Web (in)	6	Yield Strength Fy (KSI)	50
Flange (in)	2-3/4	Design Thickness (in)	0.0566
Mils	54	Minimum Thickness (in)	0.0538
Finish	G60	Gauge	16



FIRE RATED DESIGNS (UL 2079):

HW-D-0514	HW-D-0554
HW-D-0518	HW-D-0573
HW-D-0524	HW-D-0620
HW-D-0550	HW-D-0624
HW-D-0551	HW-D-0652
HW-D-0553	WW-D-0104

CODES & STANDARDS

- IBC 2015, 2012
- Steel and coating meets ASTM A1003

GREEN INFO

- LEED v3 & LEED v4 credits available
- Contact Technical Services for more information

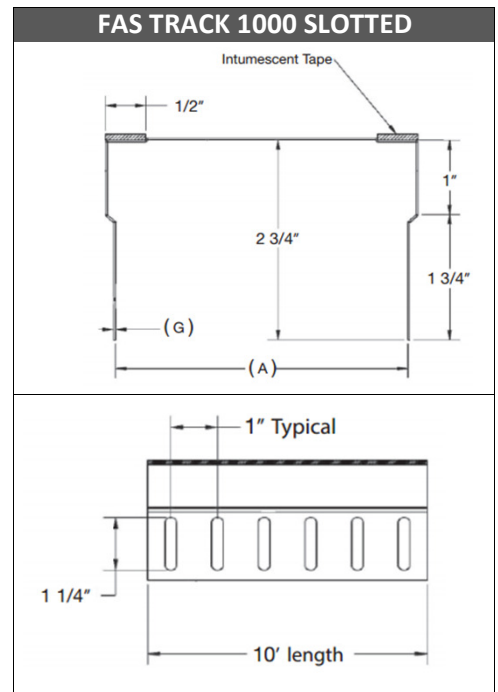

ALLOWABLE LOADS:

MODEL NO. ¹	DESIGN THICKNESS (in)	MINIMUM THICKNESS (in)	YIELD (ksi)	COATING	WEB SIZES (in)	GAP ² (in)	ALLOWABLE LOAD ³ PER STUD (lb)	LOAD AT 1/8 INCH DEFLECTION ⁴ (lb)
33	0.0346	0.0329	33	G40	2 1/2 3 5/8 4 6 8	5/8	125	30
43	0.0451	0.0428	33	G60	2 1/2 3 5/8 4 6 8	5/8	160	50
54	0.0566	0.0538	50	G60	2 1/2 3 5/8 4 6 8	5/8	280	90
68	0.0713	0.0677	50	G60	3 5/8 4 6 8	5/8	385	155

For SI: 1 inch = 25.4mm, 1 lbf = 4.448 N, 1 ksi = 6.8948 kPa, 1 lb/ft = 14.5939 N/m

¹See the last two digits in the section designation in Table 2.

²The gap is the maximum distance between end of the stud and the web of the track.

³Loads are allowable strength loads (ASD). For load and resistance factor design (LRFD) multiply by 1.54.

⁴Deflection is the deflection of the edge of the flange away from the web of the FAS Track 1000.



www.marinoware.com

For more information, please contact Marino\WARE Technical Services at 866-545-1545.

This technical information reflects the most current information available and supersedes any and all publications, effective 4/1/2016
©Copyright 2016 by Ware Industries, Inc. All rights reserved