

Marino\WARE® Product Submittal Data

MARINO\WARE PART # 1125JS-362 Web Stiffener

MATERIAL: 16 ga (54 mil) 50ksi
FINISH: Galvanized – G90

Part No.	Size (in.)	Box Qty
8JS-362	8"	24
925JS-362	9-1/4"	24
10JS-362	10"	24
1125JS-362	11-1/4"	24
12JS-362	12"	24
14JS-362	14"	24

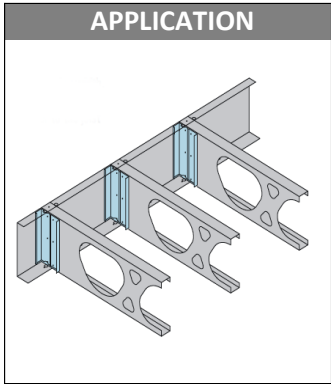
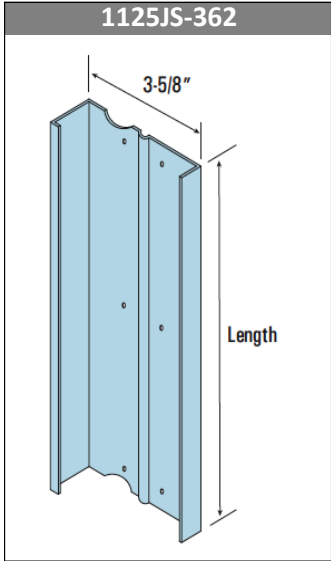

GREEN INFO LEED® v3

Available LEED® points in the following categories:

- MR Credit 2 - Construction Waste Management (1-2 points)
- MR Credit 4 - Recycled Content (1-2 points)
- MR Credit 5 - Regional Materials (1-2 points)

- Total Recycled Content: 34.9%
- Post Consumer Content: 24.3%
- Pre Consumer (Post Industrial) Content: 9.4%



For more information, please contact Marino\WARE Technical Services at 866-545-1545.

This technical information reflects the most current information available and supersedes any and all publications, effective 12/1/2010.

© Copyright 2010 by Ware Industries, Inc. All rights reserved