

Technical Work Sheet
 Toll Free: 866.545.1545 | Fax: 770.507.2605
 email: technicalservices@marinoware.com
www.MarinoWARE.com

PROJECT NAME _____

ARCHITECT / ENGINEER / CONTRACTOR _____

PHONE # _____

PROJECT LOCATION (COMPLETE ADDRESS) _____

CONTACT PERSON _____

EMAIL ADDRESS _____

DATE _____

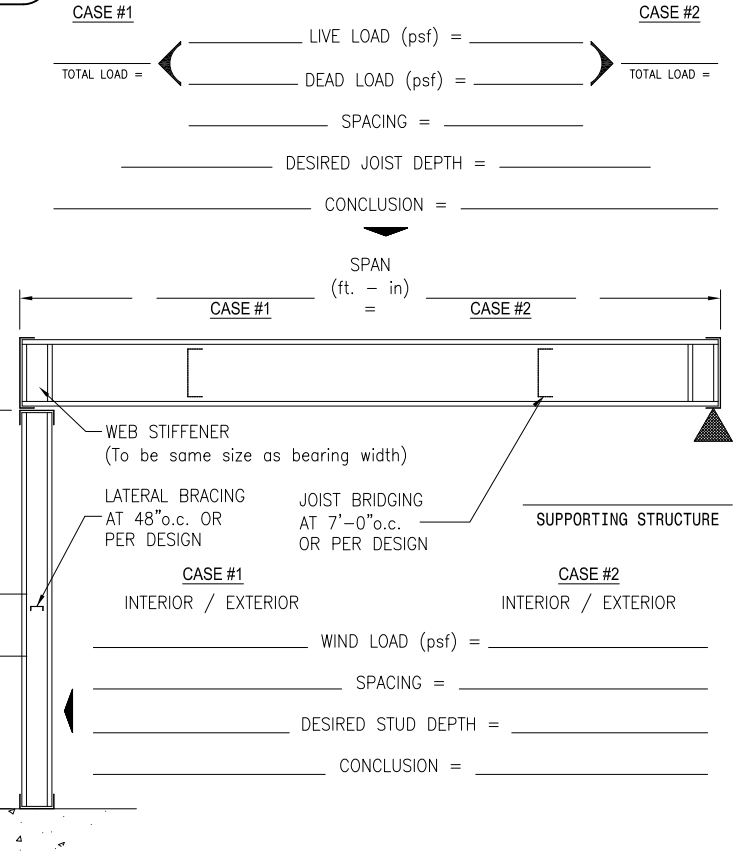
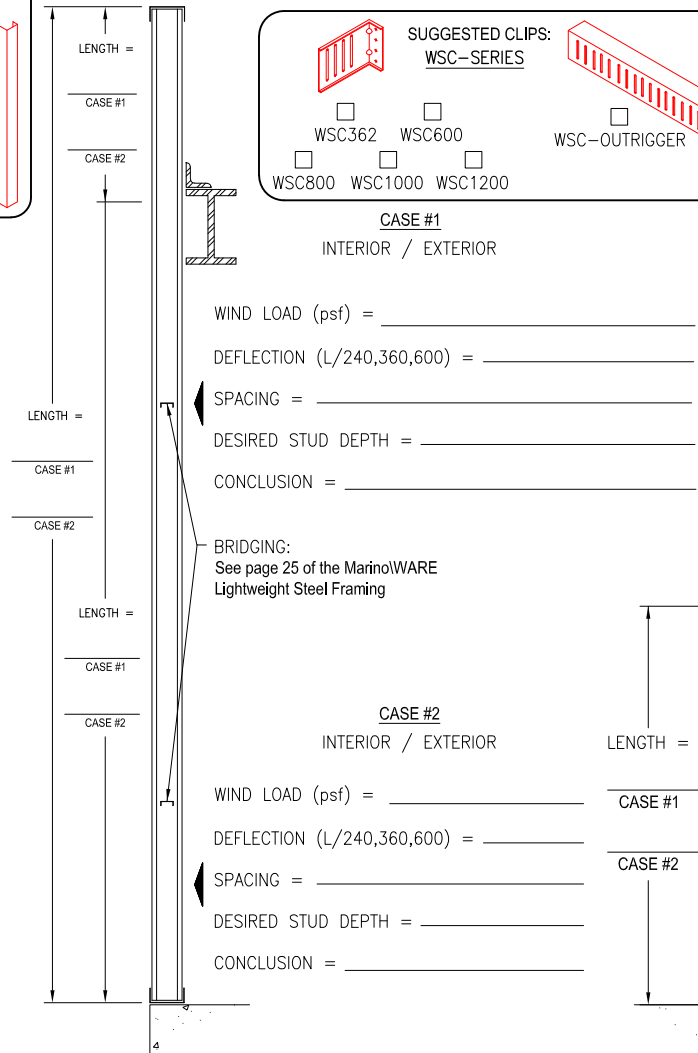
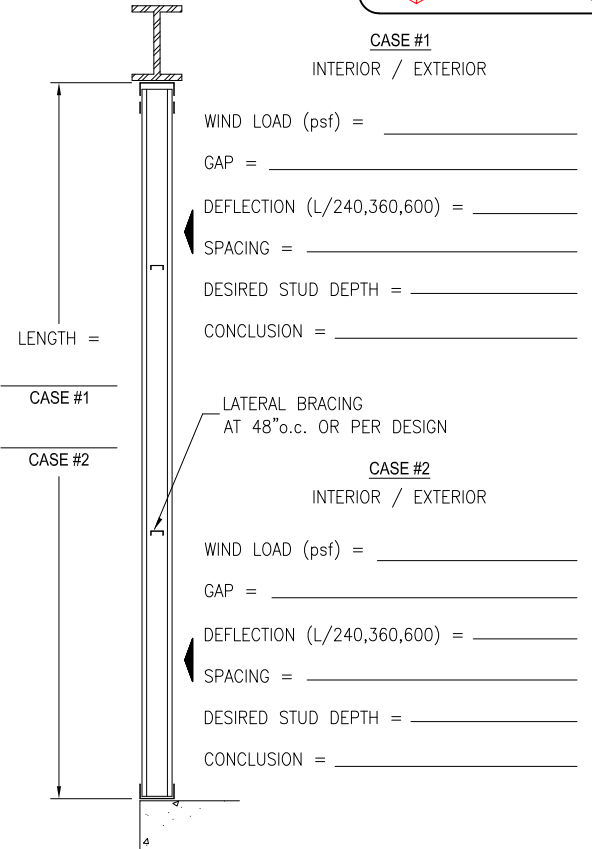
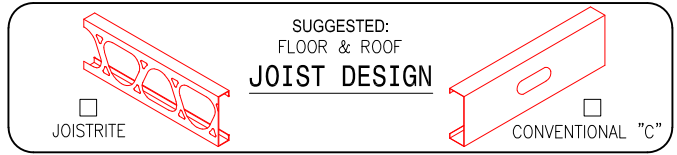
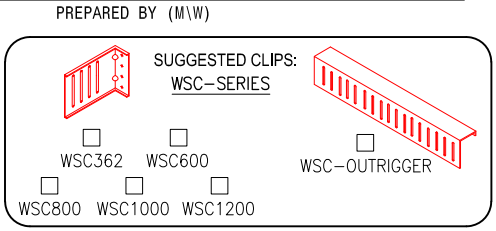
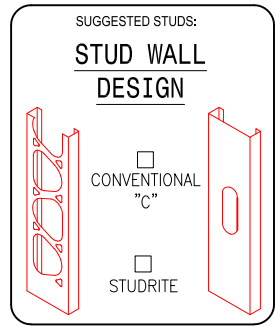
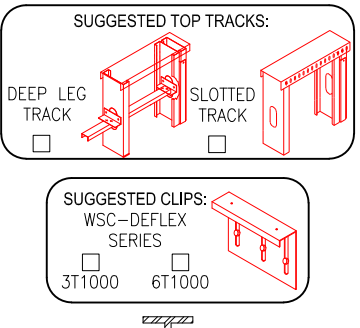

CURTAIN WALL (IN-FILL)

CURTAIN WALL (BY-PASS)

BEARING WALL

THE CALCULATIONS AND/OR SKETCHES CONTAINED HEREIN ARE SUPPLIED SOLELY TO ASSIST IN THE SELECTION AND/OR ANALYSIS OF MARINOWARE PRODUCTS. THE CALCULATIONS AND/OR SKETCHES ARE PRELIMINARY IN NATURE AND ARE NOT INTENDED TO REPLACE THE CALCULATIONS AND/OR SKETCHES AND SERVICES OF THE ARCHITECT OR ENGINEER OF RECORD. MARINOWARE IN RENDERING SUCH CALCULATIONS AND/OR SKETCHES SHALL IN NO WAY BE DEEMED TO ASSUME ANY PROFESSIONAL RESPONSIBILITY AND HEREBY DISCLAIMS ANY AND ALL SUCH LIABILITY OR OBLIGATION.