

VIPERSTUD
Product Catalog



By providing a lighter, stronger,
more efficient framing system,
ViperStud® has earned the trust
of industry leaders nationwide.
Made from high-strength steel
and formed with exclusive
ViperRib technology,
ViperStud® is the flat steel
system that will be here
for the long term,
you can count on that.

The Proprietary Steel Framing System That Has Withstood The Test Of Time...

A Track Record You Can Count On, Verified Code Compliant

ViperStud® Drywall Framing System is tested or conforms to these standards:

- **ASTM A1003** Standard Specification for Steel Sheet, Carbon, Metallic- and Nonmetallic-Coated for Cold-Formed Framing Members
- **ASTM C645** Standard Specification for Nonstructural Steel Framing Members
- **ASTM C754** Standard Specification for Installation of Steel Framing Members to Receive Screw-Attached Gypsum Panel Products
- **ASTM E90** Standard Test Method for Laboratory Measurement of Airborne Sound Transmission Loss of Building Partitions and Elements
- **ASTM E119** Standard Test Methods for Fire Tests of Building construction and Materials. Fire rated for 1, 2, 3, and 4 hour rated walls.
- **ASTM E72** Standard Test Methods of Conducting Strength Tests of Panels for Building Construction
- **ASTM C1629** Standard Classification for Abuse-Resistant Nondecorated Interior Gypsum Panel Products and Fiber-Reinforced Cement Panels
- **AISI S220** North American Standard for Cold-Formed Steel Nonstructural Framing.
- **AISI S100-16/S2-20** North American Specification for the Design of Cold-Formed Steel Structural Members

Intertek Certified

Viper25, Viper20, Viper 30 mil, and Viper 33mil manufactured by Marino\WARE® received an evaluation report (CCRR-0154) from Intertek's Code Evaluation Program, providing evidence that the ViperStud Drywall Framing System meets code requirements. Building officials, architects, contractors, specifiers, designers and others utilize these Evaluation Reports to provide a basis for using or approving metal framing in construction projects following the International Building Code.

LEED® v4 Information

- Product Specific Type III EPD
- Published HPD
- SDS Sheets

ViperStud® is listed in the following:

- Intertek CCRR-0154
- NYC Department of Buildings MEA 56-08-M, MEA 56-08-M Vol 2, MEA 235-08-M

Please see the full version of these reports online at www.marinoware.com

Code Information

ViperStud® Drywall Framing has been verified by the following Accredited Test Agencies and/or certified by the Product Evaluation Agencies listed here.

IBC 2015, 2018, 2021, 2023 FBC Compliant

Patents:

US D621,963 | US D621,964
CAN 134144 | CAN 134143



TECHNICAL SERVICES + SUPPORT | DesignGroup

Our commitment to quality products extends to best-in-class design support. The Marino\WARE® DesignGroup™ offers a full range of technical support and engineering services, including professionally engineered stamped shop drawings, design and installation assistance on all Marino\WARE manufactured products, and expert advice on structural, nonstructural, fire and acoustic assemblies.

If you have questions or need more information on any of the products listed in this catalog, contact our Technical Services department at technicalservices@marinoware.com, or at 866.545.1545. In most cases Technical Services representatives can provide an immediate response.

Warranty & Limitations

All products presented herein are warranted to the buyer to be free from defects in material and workmanship. The foregoing warranty is non-assignable and in lieu of and excludes all other warranties not expressly set forth herein, whether express or implied by operation of law or otherwise, including but not limited to any implied warranties of merchantability or fitness for a particular purpose. All details and specifications presented herein are intended as a general guide for the use of Marino\WARE® framing systems. These products should not be used without evaluation by a qualified engineer or architect to determine their suitability for a specific use.

Marino\WARE® assumes no responsibility for failure resulting from use of its details or specifications, or for failure resulting from improper application or installation of these products.

Governing Law

All issues arising in connection with your order and all transactions associated with it shall be interpreted according to the laws of the State of New Jersey, and all actions or other proceedings arising out of such issues shall be brought only in Superior Court, State of New Jersey, County of Essex, or United States District Court for the District of New Jersey. No action may be brought more than one year after accrual of the cause of action therefore.

A High Strength, Flat Steel Drywall Framing System

The ViperStud® Drywall Framing System offers all the benefits of conventional flat steel studs with a design that performs even better. The ViperStud drywall framing system is interchangeable with conventional framing components. Since ViperStud is flat steel, it is easy to plumb and mark, make minor adjustments and use laser levels. This makes installation the same as conventional studs. No extra training or special fasteners are required for installation.

Knurl & Rib Technology

The stud and track system utilizes a knurled flange and reinforcing ribs along with a flat stud design. Knurling is the pattern of small ridges formed on the flange to prevent screws from walking. Since knurling is only formed on one side of the steel, the stud stays flat, never compromising the strength or thickness of the steel.

ViperRib® technology applies a reinforced ribbing over the web and flange of ViperStud. The ribs provide added strength, are less prone to twist and creating "high-shoulders" when finishing gypsum board.

ViperRib® Technology
makes ViperStud stronger
& less prone to twist or buckle.

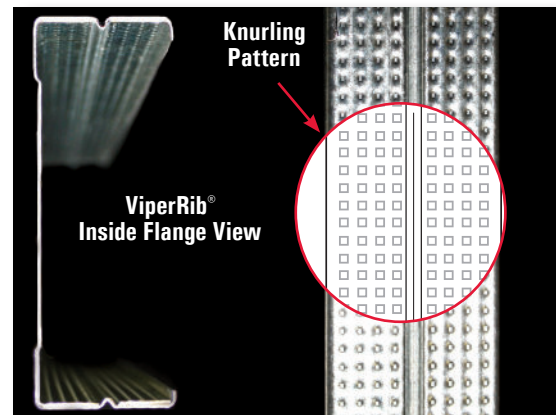
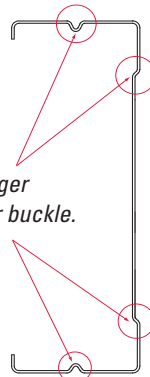

The One-Track System

We've tested ViperTrack25 extensively with Viper25 and Viper20 studs. Our third-party testing proves that it is not necessary to use the same thickness track as the stud. Now you can submit a lighter gauge track with your Viper20 studs and reduce your cost.

- Saves money
- Fewer items to inventory
- Safer, ViperTrack25 is fully hemmed
- Supported by testing

Not applicable for Impact or Abuse Rated walls. Fire rated walls should be built per specific assembly requirements.

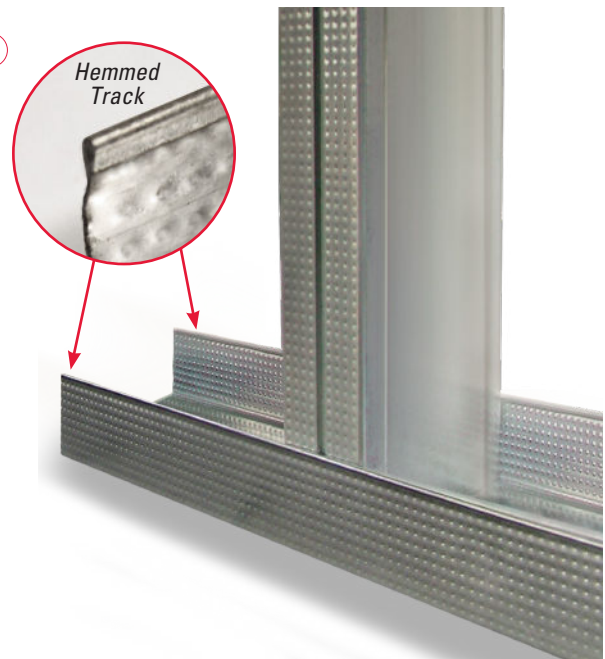

ViperStud®

MODEL NO.	DESIGN THICKNESS (in.)	YIELD STRESS (ksi)	WEB SIZES (in.)	FLANGE (in.)	RETURN LIP (in.)	Color Code
VIPER25	0.0155	50	1-5/8, 2-1/2, 3-5/8, 4, 6	1-1/4	1/4	NONE
VIPER20	0.0190	70	1-5/8, 2-1/2, 3-5/8, 4, 6	1-1/4	various	BROWN
VIPER 30mil	0.0312	33	1-5/8, 2-1/2, 3-5/8, 4, 6	1-1/4	1/4	PINK
VIPER 33mil	0.0346	33	1-5/8, 2-1/2, 3-5/8, 4, 6	1-1/4	1/4	WHITE

ViperTrack®

MODEL NO.	DESIGN THICKNESS (in.)	YIELD STRESS (ksi)	WEB SIZES (in.)	LEG SIZE (in.)
VIPERTRACK25	0.0155	50	1-5/8, 2-1/2, 3-5/8, 4, 6	1-1/4
VIPERTRACK20	0.0190	50	1-5/8, 2-1/2, 3-5/8, 4, 6	1-1/4
VIPERTRACK 30mil	0.0312	33	1-5/8, 2-1/2, 3-5/8, 4, 6	1-1/4
VIPERTRACK 33mil	0.0346	33	1-5/8, 2-1/2, 3-5/8, 4, 6	1-1/4

Notes:

1. Coatings G40EQ per AISI S220, ASTM C645 or ASTM A 1003, Table 1.
2. CP60 and CP90 available upon request.
3. Knockout size for 1-5/8" & 2-1/2" Stud is 3/4" x 1-3/4". Knockout size for 3-5/8", 4", & 6" Stud is 1-1/2" x 2-1/2"

Viper25 (15 mil) is equivalent to conventional 25 gauge (18 mil) studs, and Viper20 (19 mil) is equivalent to conventional 20 gauge studs (30 mil).



DEEP LEG DEFLECTION TRACK

Deflection track can be required at the top of a wall to allow for anticipated downward movement of the primary structure. A gap is provided between the end of the stud and track to accommodate this movement. The studs are not fastened to the track to allow movement up or down. The bridging is required within 12" from the top to keep the stud in place and provide rotational restraint. The leg of the track must be long enough to provide the required gap, bearing surface for the studs and allow for construction tolerances.

MODEL NO.	DESIGN THICKNESS (in.)	YIELD STRESS (ksi)	WEB SIZES (in.)	LEG SIZE (in.)	GAP (in.)	LOAD (lb.)	MAX HEIGHT 5 psf, 16" o.c.
VIPERTRACK25	0.0155	50	1-5/8, 2-1/2, 3-5/8, 4, 6	2"	1/2"	34	10'-4"
VIPERTRACK20	0.0190	70	1-5/8, 2-1/2, 3-5/8, 4, 6	2"	1/2"	72	21'-6"
			2-1/2, 3-5/8, 4, 6	2-1/2"	3/4"	48	14'-4"
VIPERTRACK 30mil	0.0312	33	1-5/8, 2-1/2, 3-5/8, 4, 6	2"	1/2"	92	27'-6"
			2-1/2, 3-5/8, 4, 6	2-1/2"	3/4"	61	18'-4"
VIPERTRACK 33mil	0.0346	33	1-5/8, 2-1/2, 3-5/8, 4, 6	2"	1/2"	113	33'-10"
			2-1/2, 3-5/8, 4, 6	2-1/2"	3/4"	75	22'-7"
			2-1/2, 3-5/8, 4, 6	3"	1"	56	16'-11"

Notes:

1. Max wall height based on track capacity and specified gap.
2. Wall height may also be limited by stud member. Check stud height separately of track capacity.
3. 1-5/8" deep leg track available with max 2" leg
4. Wall studs are not fastened to deep leg track.
5. G60, G90 available upon request.
6. Coating per AISI S220, ASTM C645 & ASTM A 1003, Table 1.

Studs are secured by one of the following methods:

A. CR channel and BRC Clip. 12" down from the stud end.

B. Attaching flat strap at each side of the stud flange. 12" down from the stud end.

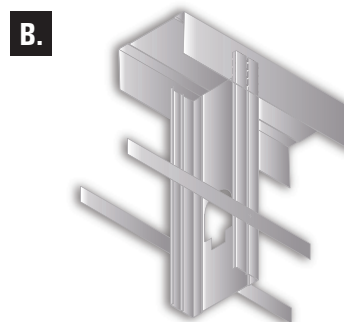
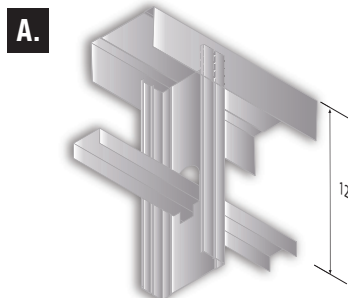

For more information, please contact MarinoWARE® Technical Services at 866-545-1545.

This technical information reflects the most current information available and supersedes any and all previous publications effective September 17, 2024 | MW-ViperStud Catalog | © WARE Industries, Inc. 2024

VIPERSTUD®

Table with columns: MODEL NO., GAUGE, MEMBER, DESIGN THICKNESS (in.), YIELD STRESS (ksi), WEIGHT (lb/ft), GROSS PROPERTIES (AREA, Ix, rx, Iy, ry), EFFECTIVE PROPERTIES (Ixd, Sx), MOMENTS (Allowable Moment, Local Buckling, Distortional Buckling, Nominal Moment, Critical Unbraced Length).

Notes:

- 1. Nominal Moments for Viper25 are based on testing. Allowable moment (Ma) is calculated with safety factor of 1.81 in accordance with chapter F of AISI S100-16/S2-20 specification.
2. Nominal moment for Viper20, Viper 30mil, Viper 33mil and conventional studs are based on calculations per AISI S100-16/S2-20.
3. Section properties are in accordance with AISI S100-16/S2-20.
4. Web depth-to-thickness ratio exceeds 200.
5. Web depth-to-thickness ratio exceeds 260.
6. ViperStud is considered fully braced when the unbraced length is less than listed Lu.
7. KPhi assumed to be zero for distortional buckling moments.

VIPERTRACK®

Table with columns: MEMBER, LEG SIZE (in.), WEIGHT (lb/ft), DESIGN THICKNESS (in.), YIELD STRESS (ksi), GROSS PROPERTIES (AREA, Ix, Sx, rx, Iy, Sy, ry), EFFECTIVE PROPERTIES (Ixd, Sxe, Ma), TORSIONAL PROPERTIES (Xo, Jx10^3, CW, ro, beta).

Notes:

- 1. See page 6 for ViperTrack notes.

Table with columns: MODEL NO., DEPTH, GAUGE, MEMBER, DESIGN THICKNESS (in.), YIELD STRESS (ksi), SPACING O.C. (in.), and three sets of limiting heights for 5 PSF, 7.5 PSF, and 10 PSF. The table is organized into sections for Viper25, Viper20, Viper 30mil, and Viper 33mil, each with sub-sections for different depths and gauges.

- Notes:
1. Limiting heights are in accordance with AISI S100-16/S2-20 using all steel non-composite design.
2. Limiting heights are established by considering flexure, shear, web crippling and deflection.
3. For bending, studs are assumed to be adequately braced to develop full allowable moment.
4. For web crippling, when h/t <= 200, the web crippling values are computed based on section G6 of AISI S100-16/S2-20, when h/t > 200, the web crippling values are based on testing with a bearing length of 1".
5. No web stiffeners are required for studs with h/t > 200, web crippling and shear values have been confirmed by testing.
6. The factory punchouts are in accordance with AISI Standards. The distance from the center of last punchout to the end of the stud is 12".
7. Use the non-composite fully braced table with 1/2" gypsum board or horizontal gypsum board. Also use for RC or furring channel (with or without sound clips), if channel is spaced at less than Lu.
8. See CCCR-0154 for additional information. Review fire rated assemblies for additional requirements.

For more information, please contact MarinoWARE® Technical Services at 866-545-1545.

This technical information reflects the most current information available and supersedes any and all previous publications effective September 17, 2024 | MW-ViperStud Catalog | © WARE Industries, Inc. 2024

MODEL NO.	DESIGN THICKNESS (in.)	Yield Stress (ksi)	Ultimate Stress (ksi)	#6 SCREW (0.138" dia; 0.25" head)			#8 SCREW (0.164" dia; 0.3125" head)			#10 SCREW (0.190" dia; 0.34" head)			C645 SCREW PENETRATION TEST (P, F)
				Shear (lbs)	Pull Out (lbs)	Pull Over (lbs)	Shear (lbs)	Pull Out (lbs)	Pull Over (lbs)	Shear (lbs)	Pull Out (lbs)	Pull Over (lbs)	
Viper25	0.0155	50	50	75 ⁹	30	97	90 ⁹	36	121	93 ⁹	42	132	Pass
Viper20	0.0190	70	70	95	52	140	104	62	195	112	72	226	Pass
Conventional (25ga)	0.0188	33	33	44	24	78	48	29	97	52	33	105	--
Conventional (20ga DW) OR Viper 30mil	0.0312	33	33	95	40	129	103	48	161	111	55	175	--
Conventional (20ga STR) OR Viper 33mil	0.0346	33	33	110	45	143	120	53	178	130	61	194	--

Notes:

1. Capacities are based on section J of the AISI S100 Specification.
2. Capacities are based on Allowable Strength Design (ASD).
3. Screw pull-out capacities are based on listed head diameter.
4. Two sheets of equal thickness and tensile strength are assumed in tabulated values.
5. When materials of different steel thickness and tensile strength are connected, use the lowest value for shear capacity (tilting and bearing), for pull-out capacity use sheet closest to screw tip and for pull-over capacity use sheet closest to screw head.
6. Where multiple fasteners are used, screws are assumed to have a center-to-center spacing of at least 3 times the nominal diameter.
7. Screws are assumed to have a center-of-screw to edge-of-steel dimension of at least 1.5 times the nominal diameter of the screw.
8. When screws are subjected to combination of shear and tension forces, interaction equation of AISI S100 Specification section J4.5 shall be used.
9. Viper25 shear values are tested per AISI S100 and AISI S905, tests conducted by Structural Testing & Research, Inc.
10. Viper20 values are calculated per AISI S100.

SCREW PENETRATION TESTING (ASTM C 645, ASTM C 1002)

To pass screw penetration tests, studs must be capable of pulling the head of the screw below surface of gypsum board in less than 2 seconds without spin out.

GYPSUM BOARD – VIPER25 & VIPER20

1/2" Type C	Viper25	#6 x 1-1/4"	2500	PASS
5/8" Type X	Viper25	Type S sharp pt	2500	PASS

HI-ABUSE/HI-IMPACT – VIPER20

SHEATHING TYPE AND THICKNESS	STEEL FRAMING	SCREW TYPE	DRILL SPEED (RPM)	C645 PASS/FAIL ASTM
USG 5/8" High Impact	3-5/8" Viper20	#6 x 1-1/4" Type S sharp pt	4000	PASS
National Gypsum 5/8" High Impact	3-5/8" Viper20	#6 x 1-1/4" Type S sharp pt	4000	PASS
Georgia Pacific 5/8" High Impact	3-5/8" Viper20	#6 x 1-1/4" Type S sharp pt	4000	PASS
CertainTeed 5/8" High Impact	3-5/8" Viper20	#6 x 1-1/4" Type S sharp pt	4000	PASS
Continental 5/8" High Impact	3-5/8" Viper20	#6 x 1-1/4" Type S sharp pt	4000	PASS

*Testing conducted by Structural Testing & Research, Inc.

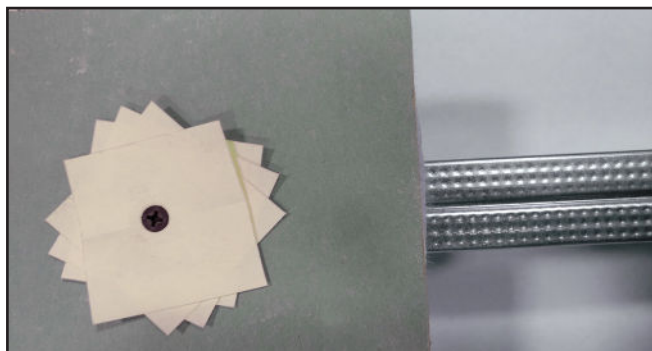
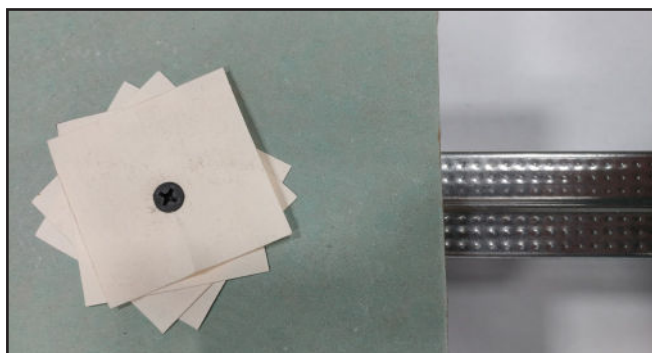

Acoustic tests were performed using 3-5/8" ViperStud steel studs. The tests were performed according to ASTM E 90 in different configurations

VIPER25 24" O.C.

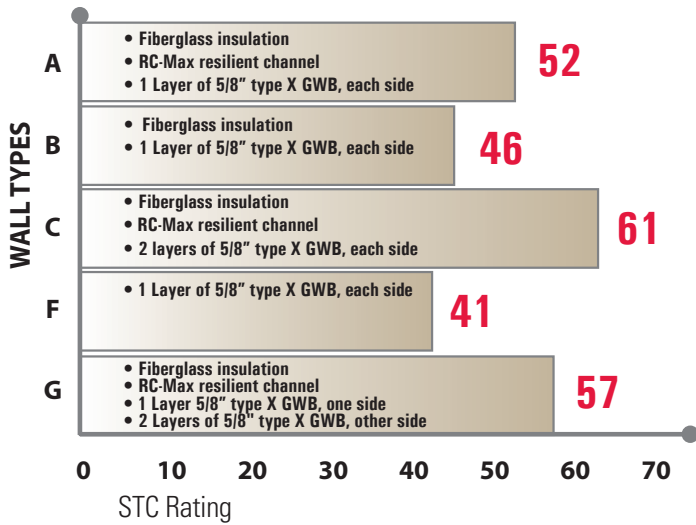

WALL TYPES

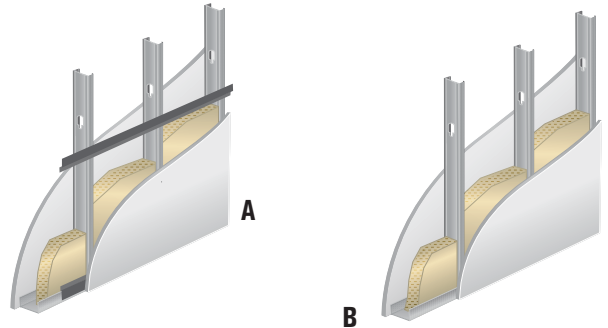

VIPER25 16" O.C.

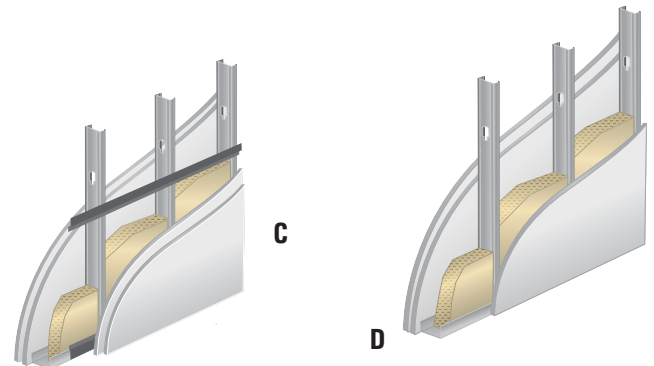
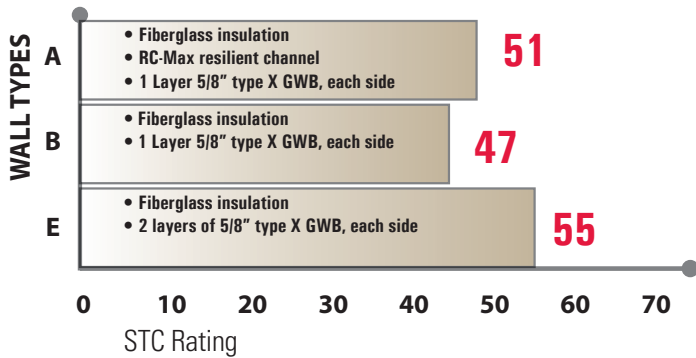

VIPER20 16" O.C.

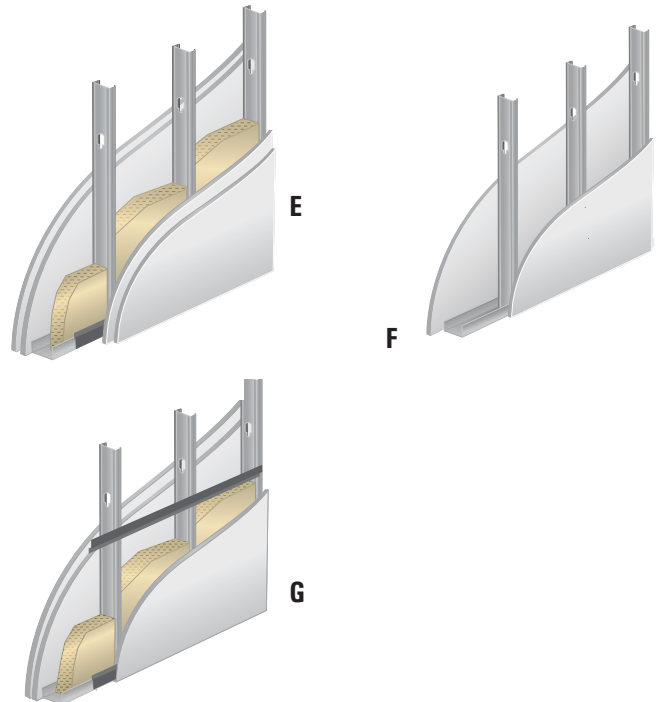
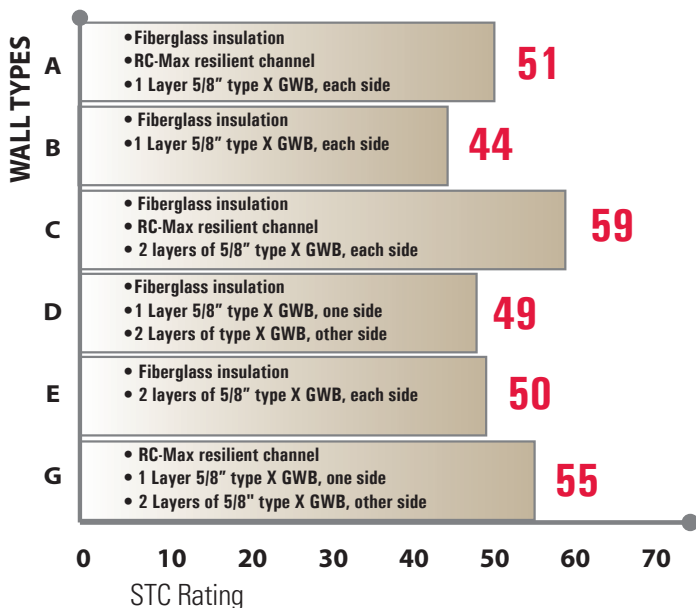

TYPICAL ASSEMBLIES (see specific design for requirements)

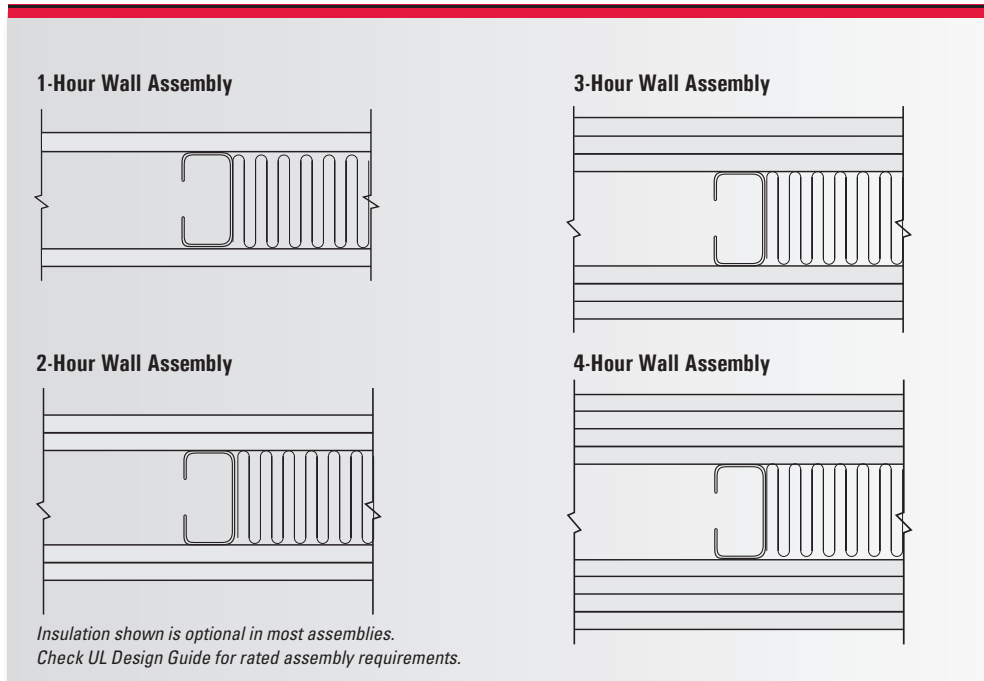

VIPERSTUD® FIRE TESTING DATA (ASTM E119)

UL Design No.	ViperStud Min. Thickness	Wall Rating:	UL Design No.	ViperStud Min. Thickness	Wall Rating:
U375	Viper25	2 HR	V416	Viper20	1 HR
U403	Viper20	2 HR	V417	Viper25	1 HR
U407	Viper25	1/2 or 1 HR	V418	Viper20	2 HR
U408	Viper20	2 HR	V419	Viper20	2 HR
U411	Viper20	2 HR	V425	Viper20	1 HR
U412	Viper20	2 HR	V435	Viper25	1 HR
U419	Viper25	1, 2, 3 or 4 HR	V437	Viper20	1 HR Chase
U420	Viper25	2 HR Chase	V438	Viper25	1, 2, 3 or 4 HR
U421	Viper20	2 HR	V443	Viper20	4 HR
U431	Viper20	4 HR	V444	Viper20	1 HR
U435	Viper20	3 HR or 4 HR	V448	Viper25	1 HR
U436	Viper20	2 HR Chase	V449	Viper20	2 HR
U444	Viper25	2 HR Chase	V452	Viper25	1 or 2 HR
U450	Viper20	1, 3 or 4 HR	V464	Viper25	1 HR Chase
U451	Viper20	1 HR	V469	Viper25	1 or 2 HR Chase
U454	Viper20	2 HR	V476	Viper20	1, 3 or 4 HR
U463	Viper20	3 or 4 HR	V486	Viper25	1, 2, or 2-1/2 HR
U465	Viper20	1 HR	V488	Viper25	1 or 2 HR Chase
U466	Viper20	1 HR Chase	V489	Viper25	1, 2, 3, or 4 HR
U471	Viper20	1-1/2 HR	V496	Viper20	1 or 2 HR Chase
U475	Viper20	1, 2, 3 or 4 HR	V498	Viper25	1, 2, 3 or 4 HR
U478	Viper20	3 HR	W411	Viper25	1/2 or 1 HR
U491	Viper20	2 HR	W415	Viper20	1 or 2 HR
U493	Viper25	1, 2 HR Chase	W423	Viper25	1/2 or 1 HR
U494	Viper20	1 HR	W424	Viper25	1/2 or 1 HR
U495	Viper20	1 or 2 HR	W432	Viper25	2 HR
U496	Viper20	1 HR	W433	Viper25	1/2 HR
V410	Viper20	2 HR	W440	Viper25	1, 2, 3 or 4 HR
V412	Viper20	2 HR	W442	Viper20	2 HR
W461	Viper20	2 HR	W443	Viper25	1, 1-1/2 HR

Note: Check UL Design assembly for minimum stud web width and other requirements. Visit www.MarinoWare.com for more information on fire rated assemblies.

Test Summary:

All tests were conducted to ASTM C 1629 standard using Test Method ASTM E 695 for Soft Body Impact Tests.

Test Materials:

Steel Studs – Viper20 Stud and track spaced 16" o.c., do not use ViperTrack25 on Viper20 studs for impact resistant walls.

Testing conducted by IAS Certified 3rd party testing lab Progressive Engineering.

SOFT BODY IMPACT CLASSIFICATION

TESTS CONDUCTED

USG

Board Type: Mold Tough® VHI Firecode® X Panels Level 3

CERTAINTEED

Board Type: Extreme Impact Level 3

AMERICAN

Board Type: M-Bloc® IR 5/8" Type X Impact Resistant Level 3

GEORGIA PACIFIC

Board Type: DensArmor Plus® Impact-Resistant Interior Panel Level 3

CONTINENTAL™

Board Type: Protecta® HIR 300 Level 3

PABCO®

Board Type: PABCO® High Impact Level 3

NATIONAL GYPSUM

Board Type: Hi-Impact® XP® Gypsum Board Level 3

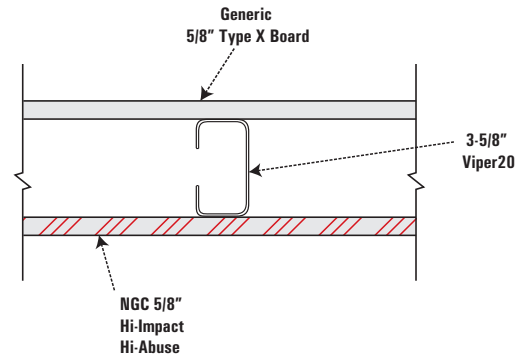

Soft body impact test using ViperStud.



AER-17109

High-Impact wallboard from seven manufacturers were tested to ASTM C1629 by Progressive Engineering, Inc. mounted on Viper20 Studs. All boards earned a Level 3 Classification (highest possible) on Viper20. The test program results are reflected in PEI Evaluation Services Report # AER-17109.

Mold Tough® is a registered trademark of USG
 Extreme Impact® is a registered trademark of CertainTeed
 M-Bloc® is a registered trademark of American Gypsum
 DensArmor Plus® is a registered trademark of Georgia-Pacific
 Protecta® is a registered trademark of Continental Building Products
 PABCO High Impact® is a registered trademark of PABCO Gypsum
 Hi-Impact® XP® is a registered trademark of National Gypsum

Specialists in Cold-Formed Steel Framing, Fire, + Acoustic Solutions



SOUND GUARD
THE SILENT STEEL FRAMING SYSTEM

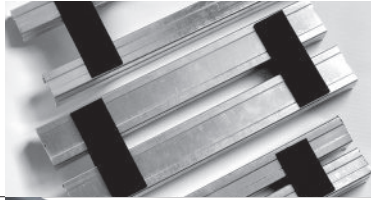

- Reduces labor and materials
- Increases available floor space
- Does not require additional bracing or resilient channel



Firestopping
Fire Bead • Fire Gasket • HotRod XL



- Firestopping and sound control for building joints
- Innovative firestop devices for faster installation
- Prevents passage of fire, smoke and toxic fumes



StudRite



JoistRite



- High strength-to-mass ratio
- Increased structural performance due to lip reinforced triangular cutouts and embossments
- Efficient design for installing plumbing, heating, electrical, and other trades
- Saves construction professionals valuable time and reduces labor costs



- Unsurpassed resistance against loads imposed by seismic activity, hurricane force winds, fire, mold, impact and blast, while actively reducing sound transmission



RC-MAX



- RC-MAX is manufactured from 0.0190" 50 KSI steel for additional strength
- Offers economical means for controlling sound transmission



ClipSource

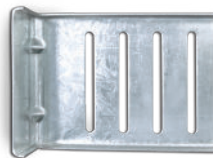

- A comprehensive line of connectors for cold formed steel framing
- Designed to facilitate quicker, more cost-effective installation, while making proper attachment of cold formed steel members easier



GenieClip



- Engineered for superior acoustical performance in reducing the transmission of airborne and impact sound through wall and floor/ceiling assemblies
- Easy and fast to install using standard steel furring channel



QuickFrame
Rough Opening System

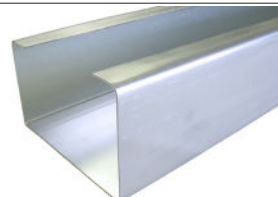

- Eliminates the need for multiple piece headers, jambs, and sills, reducing jobsite labor assembly time by more than 50%

YOUR SUCCESS DEPENDS ON QUALITY BUILDING PRODUCTS AND SO DOES OURS.

For over 30 years, Marino\WARE[®], a division of Ware Industries Inc., has served our customers with top quality cold-formed steel framing products, while delivering better solutions to design and construction challenges. We are committed to providing a superior customer experience through a vast selection of readily available products, a knowledgeable sales team, comprehensive technical support and services, prompt delivery through our fleet of trucks, and an extensive distribution network.

Our best-in-class product development team delivers innovative solutions to installation and cost challenges with products designed to save time, labor, and materials. In addition, we utilize the latest in roll forming techniques, maintain the latest level of technology available to the steel framing industry, and strictly adhere to all ASTM specifications.

Marino\WARE is 100% American-owned and operated. We take pride in creating local jobs, supporting local communities, and manufacturing products that reflect the uncompromising skill and ethics of our professional team. We operate state-of-the-art production facilities in New Jersey, Georgia, and Indiana, as well as a sales office in New York.

Visit MarinoWARE.com to experience our full line of innovative solutions.

For more information, please contact Marino\WARE[®] Technical Services at 866.545.1545

This technical information reflects the most current information available and supersedes any and all previous publications effective September 17, 2024 | MW-ViperStud Catalog | © WARE Industries, Inc. 2024

Marino\WARE[®] operates state-of-the-art production facilities in New Jersey, Georgia, and Indiana, as well as a sales office in New York.

New Jersey Facility
400 Metuchen Road
South Plainfield, NJ 07080
800.627.4661
908.757.9000
Fax: 908.412.1442

Georgia Facility
777 Greenbelt Parkway
Griffin, GA 30223
800.504.8199
678.688.1312
Fax: 678.688.1379

Indiana Facility
4245 Railroad Avenue
East Chicago, IN 46312
866.636.6002
219.378.7100
Fax: 219.378.7106

New York Sales Office
51 John St. Ste. 1
Babylon, NY 11702
800.627.4667
631.691.2200
Fax: 631.691.1492

Marino\WARE[®] DesignGroup[™]
100 Hendrick Drive, Suite 200
McDonough, GA 30253
866.545.1545
678.688.7780
Fax: 770.507.2605