

DESIGNER WALL SYSTEMS

Make Primary Space a Show Space



Surface Systems[®] • Modules[™] • Sieva[™]

 **Marlite**[®]



Primary Spaces

Markets Served

Healthcare Facilities
Schools & Universities
Restaurants
Hotels & Casinos
Houses of Worship

Transportation Terminals
Office & Residential Buildings
Fitness Centers & Spas
Grocery, Convenience & Drug Stores
Government Buildings

Walls That *welcome*

Primary Spaces: Atriums, lobbies, main corridors, executive suites, conference rooms, offices

Warm
Inviting
Accessible
Complementary
Hospitable
Harmonizing





Use Marlite Designer Wall Systems to define space while adding your own artistic signature. Marlite's extensive array of products for Primary Spaces makes installing panels on vertical surfaces simple. Each system provides design flexibility to create the perfect wall presentation.





Surface Systems[®]

Your most versatile ensemble of surface materials, finishes and colors, with pre-engineered clip application hardware and trim options. See Page 8



Modules[™]

Interior wall system comprised of 15 standard square and rectangle panel sizes – engineered with tongue and groove joinery to form fine detailed grid patterns. See Page 18



Sieva[™]

Durable High Pressure Laminate (HPL) wall system offering an array of panel sizes, configurations and reveal types for a strong, secure installation. See Page 24

1947

FALL

JOE MONTGOMERY
1973

Then... & Now...

CARY FIELD

EARL STADIUM

1973

1980

COACH JIMMY LAYCOCK

FOOTBALL
Tribe

JIMMY LAYCOCK

1990

1989

1990

1993

TRADITION

2004

1986

1994

1996

2004

1984

1996

2004



Then Select the
Finishes



Wood Veneers see page 29

Automated stain and top coat precision applied to the most select AA grade veneer.



Azure™ Woods see page 33

Exclusive imaging process creates real wood brilliance without the environmental impact.



Marlite Finish see page 37

Richly detailed wood grain prints are economical and easy to maintain.



Metal Panels see page 40

Wide ranging palette varies from soft and natural to dominant and bold.



Phenolic-Ultra Durable see page 42

Beautiful and ultra-tough compact laminates offer the ultimate in wall protection.



High Pressure Laminates see page 42

Thousands of laminates are available from all the major national brands.



Additional Capabilities see page 42

Photo murals, decals, graphic images, tackable surfaces and fabric acoustic panels.



Surface Systems®

Is a contemporary modular wall panel system featuring 3/4" thick panels that are easily attached to a subwall using Marlite's clip application system. Surface Systems provide the most effective means of applying a wide range of natural materials and faux finishes to flat and radius walls.

Features and Benefits

- Select from a wide range of natural materials and faux finishes used together or separately to provide tremendous design flexibility.
- 3/4" thick panels easily attach to a subwall using our clip system. The mechanically applied panel (MAP) system requires minimal adhesive.
- All projects are individually manufactured to specification, allowing control of panel layouts, sizes, materials and finishes.
- Engineered components handle most architectural details including radius walls.

Panel Sizes – Per specification. Minimum size 8" x 8"
Maximum size 16 Sq. Ft.

Panel Thickness – 3/4" MAP System
1/4" Adhesive System
3/8" MAP Ultra Durable

Panel Construction – Finish/Face, Medium Density Fiberboard (MDF) core, backer (if necessary)

Class A Fire-Rating is available.





Finish *Options*



Wood Veneers see page 30



Azure Woods see page 34



Marlite Finish see page 38



Metal Panels see page 44



Phenolic-Ultra Durable see page 46



High Pressure Laminates see page 46



Additional Capabilities see page 46

Photo murals, decals, graphic images, tackable surfaces and fabric acoustic panels.



Reveal Options



1/16" Hidden Reveal
Horizontal and Vertical



1/2" Channel Reveal Horizontal,
1/4" Narrow Reveal Vertical

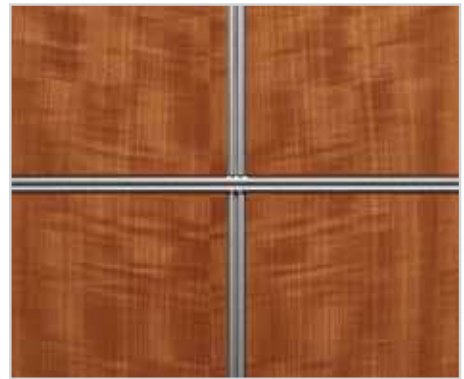

1/2" Channel Reveal
Horizontal and Vertical



1/4" Narrow Reveal
Horizontal and Vertical

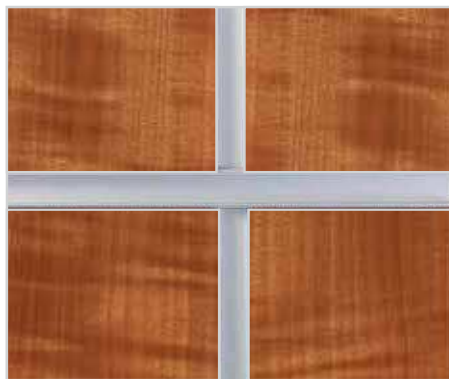

1" Broad Reveal,
Horizontal and Vertical

Note: Horizontal edges are square cut, vertical edges are kerfed to accept cross splines.

Trim and Hardware Options

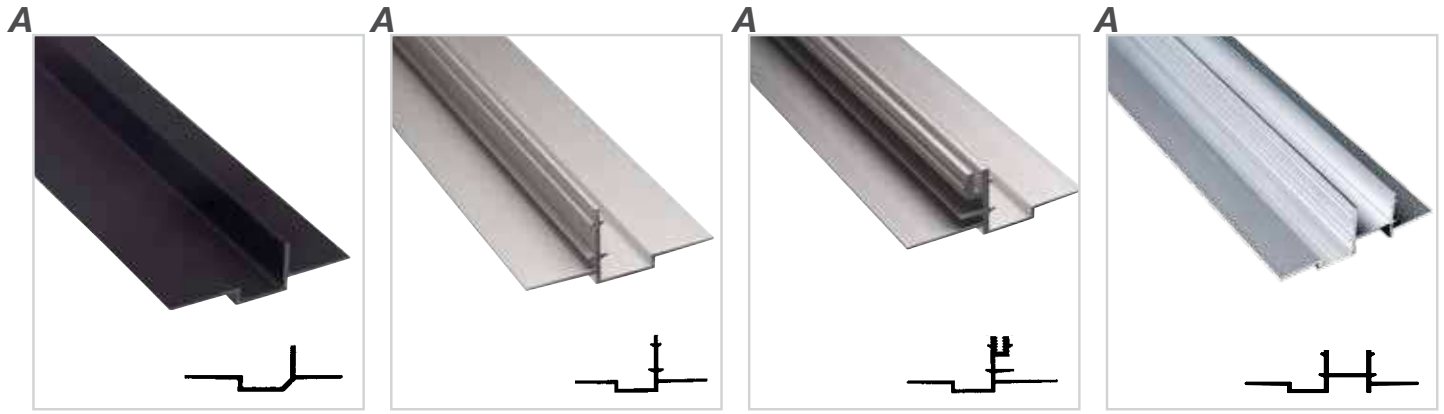

1/16" Hidden Main Rail*
(Black only)

1/4" Narrow Main Rail*

1/2" Channel Main Rail*

1" Broad Main Rail

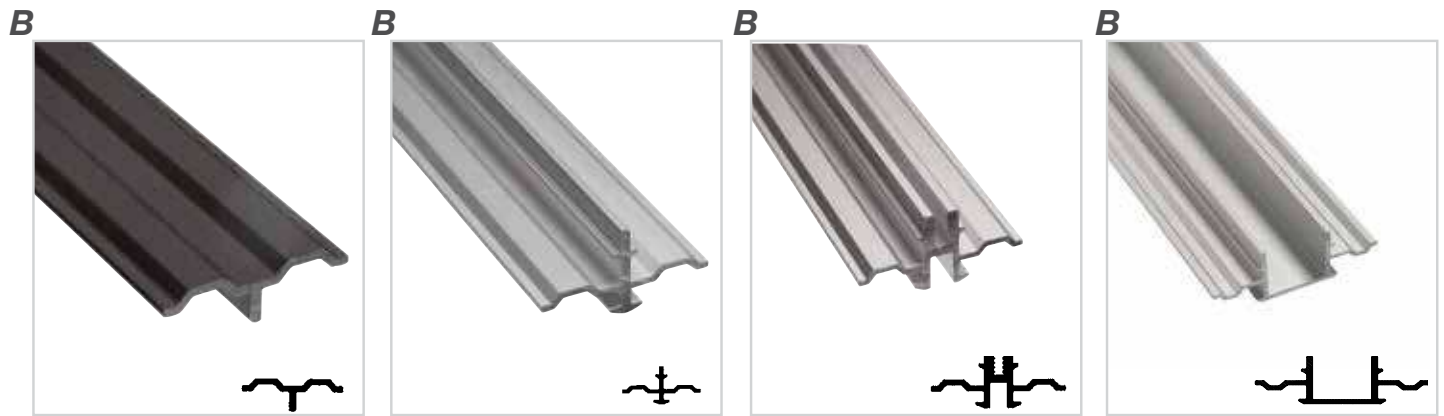

1/16" Hidden Cross Spline
(Black only)

1/4" Narrow Cross Spline

1/2" Channel Cross Spline*

1" Broad Cross Spline

NOTE: 10' lengths unless noted, available in clear satin anodized and black satin anodized.

*Available in 8' only.

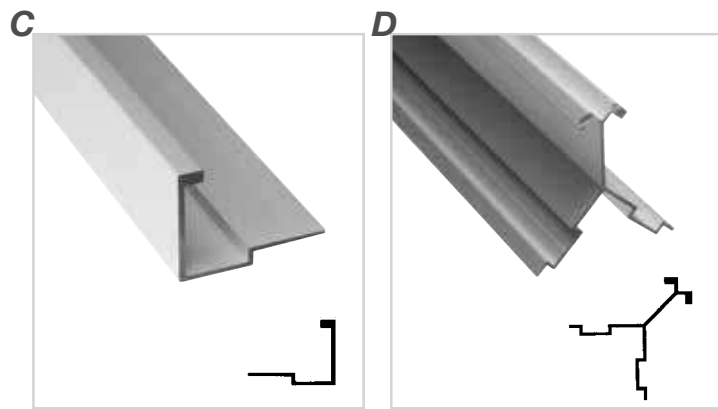

NL-770 Edge Trim and Inside Corner Trim

NL-760 Outside Corner Trim

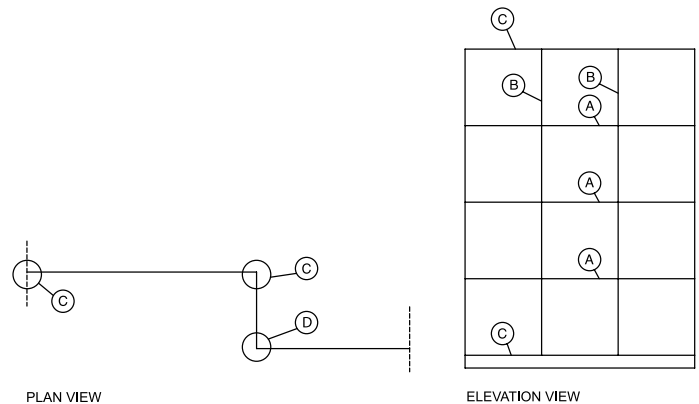

Available in clear satin anodized and black satin anodized, Surface Systems offers a wide variety of trim options, enabling you to finish your application with the perfect details.



Marlite offers alternative systems for special application requirements.

- Surface Systems Radius Wall
- Surface Systems 375 Ultra Durable
- Surface Systems 1/4" Adhesive Systems

Horizontal Main Rails fasten to the subwall. Clips, pre-applied to specially machined panels, attach to the Main Rail. Vertical Cross Splines lock adjacent panels together.



Surface Systems Radius Wall

Available in 3/4" MAP system only; Surface Systems Radius Wall is a pre-engineered system designed for easy installation and includes all molding and trim components. Radius Wall gives you the flexibility to choose from a variety of finishes including wood and metal veneers, laminates and painted finishes. Flexible Horizontal Cross Spline provides convex and concave curves with a minimum 10' radius and seamless transition from straight to curved walls.

Surface System Radius Wall Reveal Options:



1/4" Narrow



1/2" Channel

Flexible Horizontal Main Runners

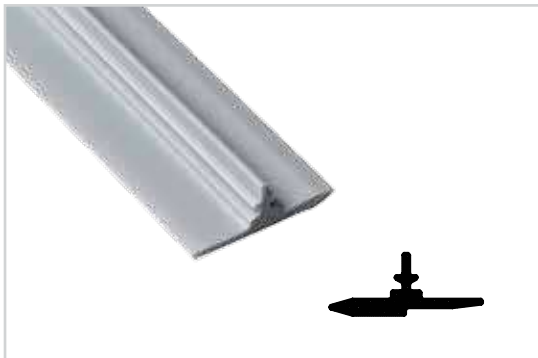

1/4" Narrow



1/2" Channel

Vertical Main Rails

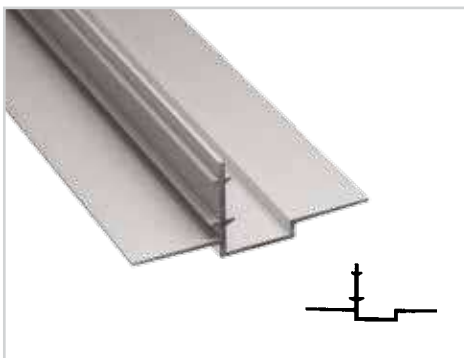

1/4" Narrow

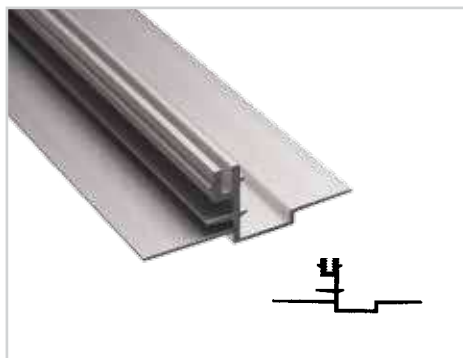

1/2" Channel

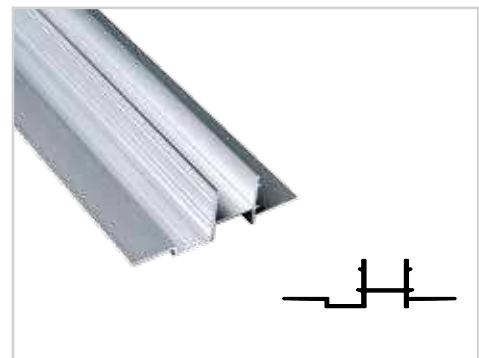

1" Broad

Trim available in black or satin finish. Edge trim and inside outside corners available.



Surface Systems 3/8" Ultra Durable Panel System. Tough, impact resistant compact phenolic laminate panels installed with Marlite's proven, pre-engineered, mechanically applied panel (MAP) Surface Systems.

Solid compact phenolic laminate is the industry's toughest panel, available in many woodgrains, colors and patterns. Thin panel reduces weight and minimizes cost.



MAP 375 Ultra Durable Reveal Options:

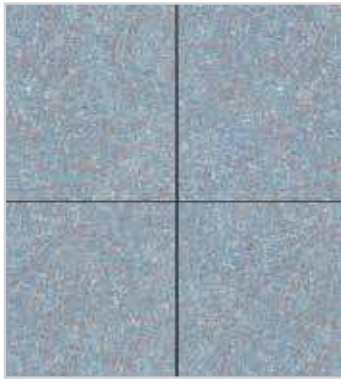

1/16" Hidden



1/4" Narrow

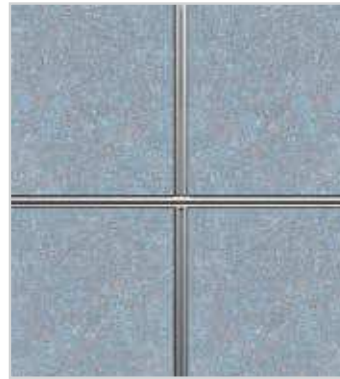

1/2" Channel



1" Broad

Horizontal Main Rails



1/16"



1/4"



1/2"



1"

Vertical Cross Splines



1/16"



1/4"



1/2"



1"

Trim available in black or satin finish. Edge trim and inside outside corners available.

1/4 Inch Adhesive System

Surface Systems 1/4" Architectural System. Thinner panels are ideal for renovations and columns. Horizontal Mainrunners and Vertical Crossrunners attach to subwall. Panels are applied using adhesive. Only available with Marlite Finish, Azure or Metal Panels. Required adhesive: C-109 Marlite Premium Adhesive (29 oz. cartridges)

1/4" Adhesive System Horizontal Main Runners + Vertical Cross Runners

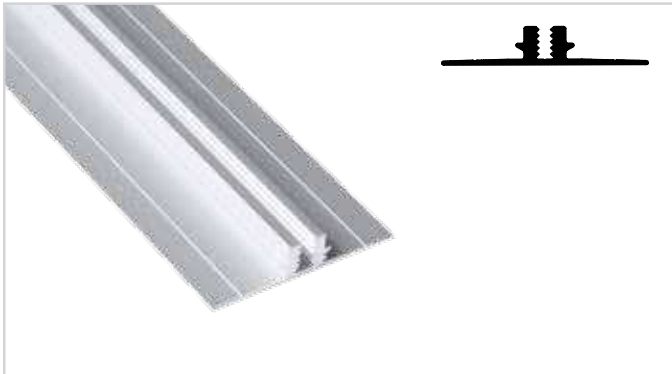

1/2" Channel

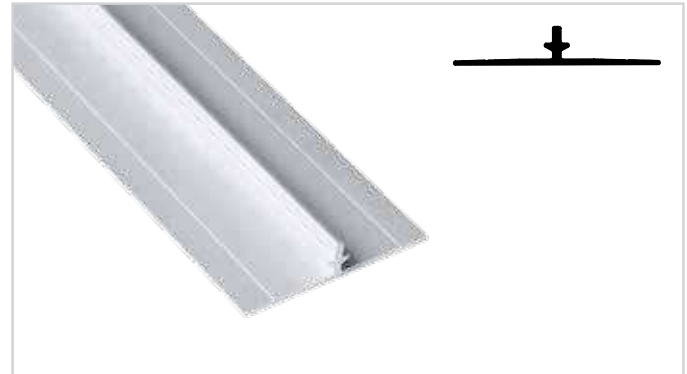

1/4" Narrow

Trim available in black or satin finish. Edge trim and inside outside corners available.



Modules™

Modules are 1/2" thick panels with engineered tongue & groove joinery that fit together to form finely detailed grid patterns on walls. With fifteen standard square and rectangle sizes, Modules can be mixed and matched to create virtually limitless wall configurations.

Features and Benefits

- Mix and match panel sizes and finishes to create dynamic wall configurations.
- 1/8" square and 1/4" chamfered reveal options provide design flexibility.
- Engineered tongue & groove joinery and easy-to-handle panel sizes make glue-up installation simple.

Panel Sizes -

	Center-to-Center Sizes
A	46 1/2" X 93" *
B	46 1/2" X 46 1/2"
C	46 1/2" X 31"
D	46 1/2" X 23 1/4"
E	46 1/2" X 15 1/2"
F	23 1/4" X 93" *
G	23 1/4" X 46 1/2"
H	23 1/4" X 31"
I	23 1/4" X 23 1/4"
J	23 1/4" X 15 1/2"
K	15 1/2" X 93" *
L	15 1/2" X 46 1/2"
M	15 1/2" X 31"
N	15 1/2" X 23 1/4"
O	15 1/2" X 15 1/2"

* 96" if not profiled on top edge.

Grain direction is second dimension (standard)

Panel Thickness – 1/2"

Panel Construction – Finish/Face, Medium Density
Fiberboard (MDF) Core

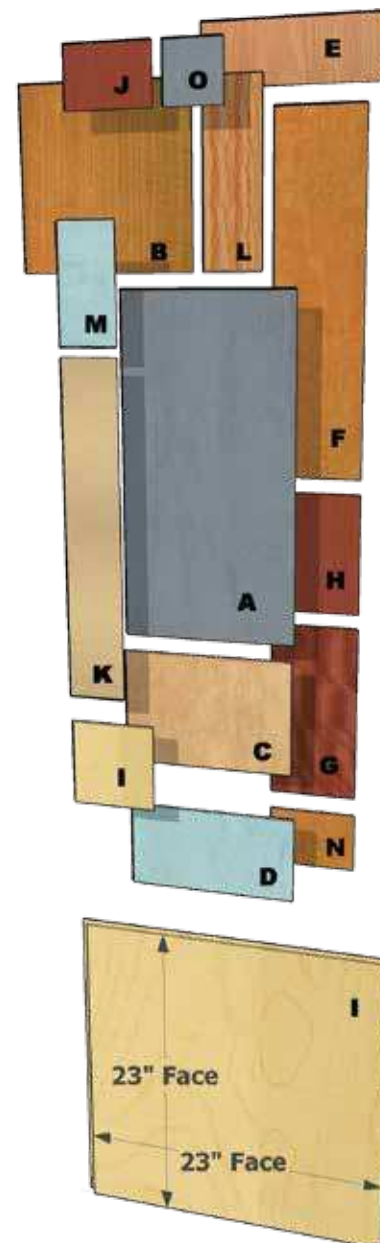



HELEN & HARRY GRAY
CANCER CENTER - Avon
HARTFORD HOSPITAL

Finish *Options*



Wood Veneers see page 30



Azure Woods see page 34



Additional Capabilities see page 46

Photo murals, decals, graphic images, tackable surfaces and fabric acoustic panels.



Reveal Options

1/8" Square Reveal

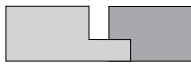

1/8" square reveal with wood veneer



1/8" square reveal with single finish



1/8" square reveal with single finish

1/8" Square Reveal



1/8" square reveal with custom reveal color

1/4" Chamfered Reveal

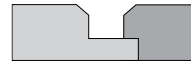

1/4" chamfered reveal with multiple finishes*



1/4" chamfered reveal with multiple finishes*

*Note: In configurations with multiple colored panels, the reveal color will be the dominant harmonizing color unless specified otherwise.

Trim and Hardware Options

Modules offers a selection of trim to ensure a finished look on edges, corners and bases. Trim is available in clear satin anodized and black powder coat.



MT-570-10 Edge/Inside Corner

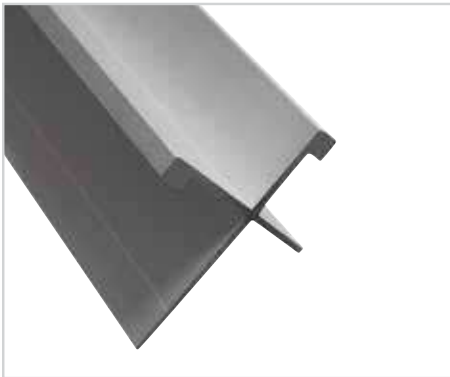

MT-560-10 Outside Corner

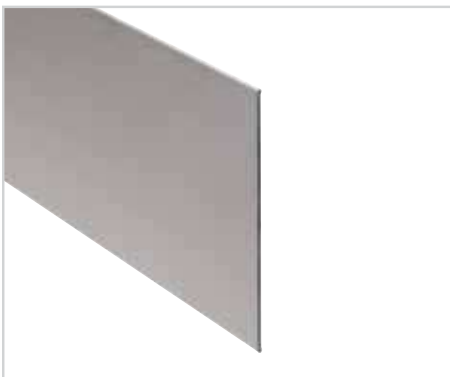

S-612-2 Base Trim

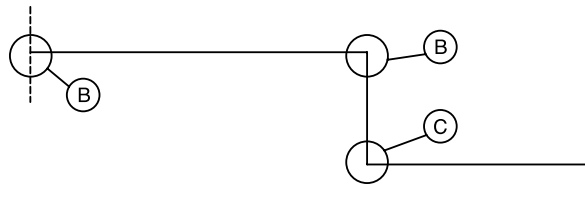

PLAN VIEW

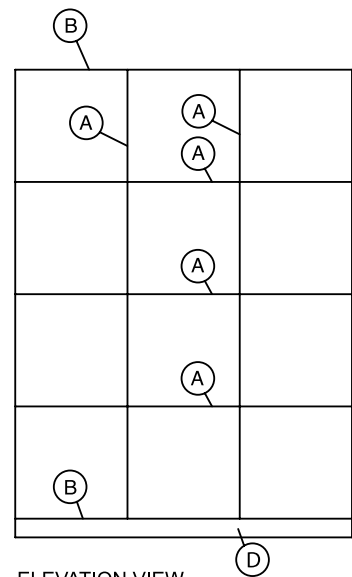

ELEVATION VIEW

NOTE: 10' lengths available in clear satin anodized and black powder coat.

Modules *Installation*





Modules easily glue to the subwall. Tongue-and-groove joinery ensures simplified installation and enables the combination of multiple sizes.







Finish *Options*

-  High Pressure Laminate see page 46
-  Graphic Designs see page 46
-  Whiteboard see page 46
-  Chalkboard see page 46
-  Tackable Surfaces see page 46





Sieva™

Sieva is a durable High Pressure Laminate (HPL) wall system using 7/16" panels for a stable and secure installation. Four different reveal options and multiple panel sizes and configurations provide the template for artistic wall design, easily and affordably.

Features and Benefits

- Attractive and durable wall panels are ideal for heavy traffic commercial areas.
- Pre-engineered reveals make installation quick and easy. Panels may contain kerfs on one or more sides.
- HPL finishes used in conjunction with battens provide a tough, easy to clean surface.
- Multiple fire-rating classifications meet the most stringent requirements for public spaces.

Panel Sizes –	Any panel size smaller than maximum 4' x 10'. Panels can be fabricated at the factory or the job site.
Panel Thickness –	7/16"
Panel Construction –	HPL face, MDF core, balancing backer
Ratings –	UL Listed Class A, Class A, Class B, Class C



Reveal Options



1/16" Hidden (CP-3)



1/8" Slim (CP-6)



3/4" Retro (CP-4)

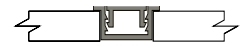

1" Bold Insert (CP-7)

Trim & Hardware Options



CP-3 1/16" Hidden Reveal
(Black only)



CP-6 1/8" Slim Reveal



CP-4 3/4" Retro Reveal



CP-7 Bold Insert Reveal



CP-270
Edge Cap Molding



CP-280
Edge/Inside Corner

NOTE: 8' and 10' lengths available in clear satin anodized and black satin anodized.



Sieva Installation



Attach the CP-280 Edge at bottom of installation and perimeter trim.



Using adhesive, install the panels and reveal.



Secure the panels and add horizontal reveal.



Add panels and reveal hardware and trim.



Create the finely detailed look of custom millwork.





Wood *Veneers*

Marlite Wood Veneers are unparalleled for two important reasons.

- We select only superior veneers far exceeding the industry standard AA grade. All our Forest Stewardship Council (FSC) certified veneers meet the most stringent requirements for quality.
- Marlite utilizes automated sanding and precision coating technology that ensures consistency and durability. By using transparent dye stains and clear topcoats with a choice of gloss level, the beauty of every veneer is optimized. We also offer customized stain colors to achieve any desired hue.

These finishes are available in 3/4" Surface Systems (SS) and Modules (MMD). When specifying a finish, please add system designation. For example: SS 8103 Anigre (Fiddleback).



8102 Anigre
(Quartered Block Mottle)



8103 Anigre
(Quartered Fiddleback)



8104 Anigre
(Quartered)



8105 Bubinga
(Flat Cut)



8107 Cherry
(Quartered)



838 Caramelized Bamboo
(Flat Cut)



8113 Makore
(Quartered Fiddleback)



8114 Maple
(Flat Cut Curly)



8111 Makore
(Quartered Block Mottle)



8123 Wenge
(Quartered Composite)



8124 Zebrawood
(Quartered)



837 Natural Bamboo
(Flat Cut)



253 Maple
(Flat Cut)



8120 Sapele
(Quartered)



8122 Walnut, African
(Quartered)

These finishes are available in 3/4" Surface Systems (SS) and Modules (MMD). When specifying a finish, please add system designation. For example: SS 8113 Makore.



299 Steamed Beech
(Quartered)



285 Birch, White
(Flat Cut)



302 Makore
(Quartered)



269 Oak, Red
(Rift)



258 Bubinga
(Quartered)



280 Walnut, American
(Flat Cut)



252 Cherry
(Flat Cut)



298 Sapele
(Flat Cut)



8115 Maple
(Quartered)



Azure Woods

Azure Woods apply Giclee (pronounced zhee, clay) imaging – accepted and renowned in the world of fine art reproduction – to the most select substrates. The result is an image quality with realism inseparable from more expensive, natural veneers.

The method produces consistency of color and tone far beyond the capability of any standard millwork offering. The eco-responsible finishing system and an eco-friendly substrate combine to have low environmental impact. With Azure Woods, Marlite can provide Architects and Designers beautiful, luxurious interiors that will become signatures of their work.

Azure™ Environmental Woods Offer:

- Inseparable realism
- Consistent colors
- Low earthly impact

Azure Wood's Breakthrough Multi-Step Finishing Process

Giclee imaging reproduction combined with Marlite's superior installation technology creates stunning interiors.

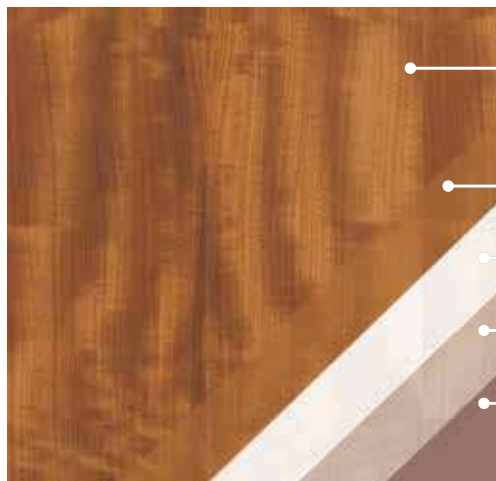

Catalyzed, Heat Cured Finish

UV Cured Image

Prime/Receptor Coat

Filler Coat

Earth Friendly Substrate

These finishes are available in Surface Systems (SS) and Modules (MMD). When specifying a finish, please add system designation. For example: SS 3101D Anigre (Quartered).



SS/MMD

3101D Anigre
(Quartered)



SS/MMD

3102D Anigre
(Quartered Fiddleback)



SS/MMD

3103D Mozambique
(Quartered Fiddleback)



SS/MMD

3104D Bamboo
(Quartered)



SS/MMD

3105D Birch, Red Ice
(Quartered)



SS/MMD

3106D Birch, White
(Flat Cut)



SS/MMD

3107D Bubinga, Waterfall



SS/MMD

3108D Cherry
(Flat Cut)



SS/MMD

3109D Makore
(Quartered Block Mottled)



SS/MMD

3110D Makore
(Block Mottled)



SS/MMD

3111D Maple
(Flat Cut)



SS/MMD

3112D Movingui
(Quartered Fiddleback)



SS/MMD

3113D Oak, Red
(Rift Cut)



SS/MMD

3114D Okoume
(Crotch)



SS/MMD

3115D Sapele
(Pommele)



SS/MMD

2116D Sapele
(Quartered)



SS/MMD

3117D Walnut, African
(Flat Cut)



SS/MMD

3118D Walnut, American
(Flat Cut)

These finishes are available in Surface Systems (SS) and Modules (MMD). When specifying a finish, please add system designation. For example: SS 3101D Anigre (Quartered).



3119D Walnut, American
(Burl)



3120D Walnut, American
(Crotch)



3121D Wenge
(Quartered)



3122D Zebrawood
(Quartered)



Marlite *Finish*

Marlite Finish is a richly detailed and easy to maintain surface that is more economical than decorative laminates. The base coat, precision and print coats and melamine topcoats are applied to the most select substrate. Each panel is baked, creating a tough, durable finish.

Marlite's Multi-Step Finishing Process

The exclusive multi-step Marlite finish process creates intricately detailed finishes that are highly durable and easy to maintain.

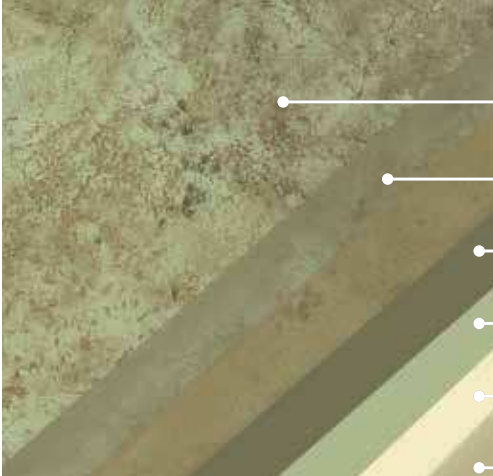

- **Melamine Durability Coat**
- **Print Coats**
- **Precision Coat**
- **Base Coat**
- **Skin Coat**
- **Select Substrate**

These finishes are available in Surface Systems (SS) and Modules (MMD). When specifying a finish, please add system designation. For example: SS 318 Windsor Anigre.



SS/MMD

5409 Townsend



SS/MMD

5410 Sebring



SS/MMD

318 Windsor Anigre



SS/MMD

319 Whittier Anigre



SS/MMD

925 Autumn Cherry



SS/MMD

310 Sierra Maple



SS/MMD

715 Mahogany



SS/MMD

463 Eastern Walnut



SS/MMD

148 Monticello Anigre

These finishes are available in Surface Systems (SS) and Modules (MMD). When specifying a finish, please add system designation. For example: SS 318 Windsor Anigre.



5346 Caramel



5347 Wheat



5344 Willow Bark



5340 Sorrell



5341 Isabelline

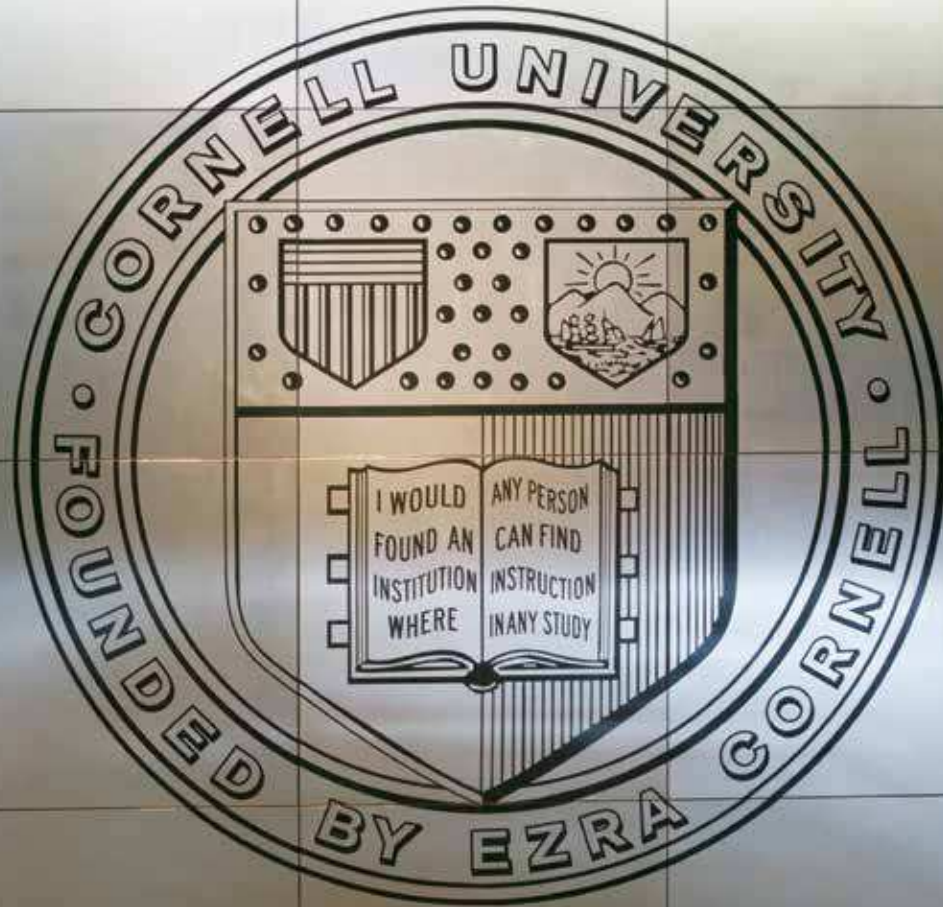

SS
SS

Metal Panels

Metal Panels, from soft and natural to dominant and bold, enhance space with structure and stability. The panels are anodized or clear-coated for a durable, easy to clean finish.

Available in Surface Systems (SS) only. When specifying a finish, please add system designation. For example: SSM-364 Brushed AlumaStainless.

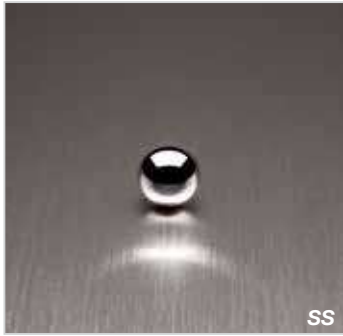

*M364 Brushed
AlumaStainless*



*M400 Matte
Natural Aluminum*



*M1145 Polished Natural
Aluminum*

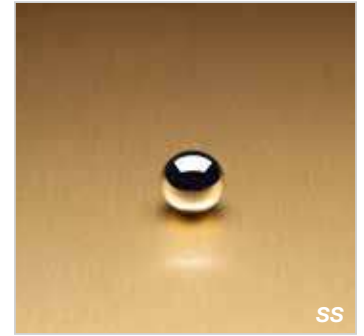

*M1151 Satin Brushed
Gold Aluminum*

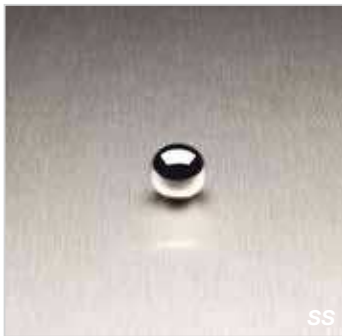

*M1146 Satin Brushed
Natural Aluminum*

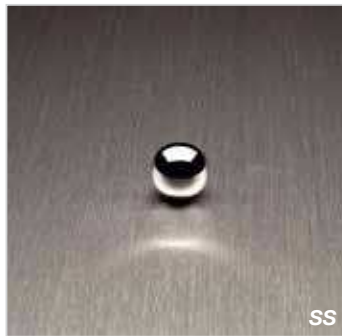

*M568 Satin Brushed
Smoke Aluminum*

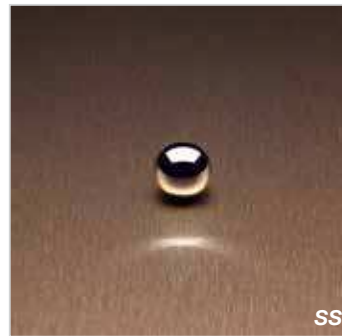

*M1147 Satin Brushed
Medium Bronze Aluminum*

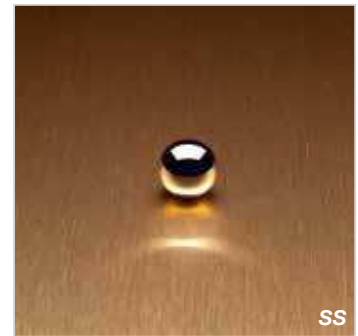

*M1150 Satin Brushed
Copper Aluminum*



*M1148 Matte Gunmetal
Grey*



*M1149 Satin Brushed
Black Aluminum*



Additional *Capabilities*

Compact Phenolic
Graphic images
Tackable surfaces
High Pressure Laminate

Acoustic fabric panels
Custom finishes
Resin panels

Marlite offers other dynamic products for commercial interiors. Please visit www.marlite.com for more details.

Walls That *wow*



Feature Walls: Focal areas and special accent walls. Perfect for branded areas.

Myriad
Volta

Walls That *work*



Secondary Spaces: Dining rooms, patient rooms, gymnasiums, kitchens, restrooms

Induro FRP
Artizan FRP
Symmetrix FRP
Envue FRP

Standard FRP
Plank
Strata Panels
Volta Flex

a³ CeramicSteel
Laminated FRP



Dover, Ohio 44622
www.marlite.com

Ph: 800.377.1221
info@marlite.com

Form No. DC116-11161

Effective Date: 2/28/17

Printed in USA

Marlite is committed to protecting our environment and sustaining resources for future generations.

Printed on Recycled Paper