

Installation Instructions

Surface Systems® Large Panel Wall System

General Notes & Product Information

Product profiles & details may vary by installation. Consult architectural drawings, details & specifications before installation of any Marlite products.

Notice: Statements expressed in this technical bulletin are the recommendations for the application of the Marlite brand products as outlined and illustrated under normal conditions of installation. The recommendations provided represent our best judgement, based on our experience with normal applications. Unless prior approval is obtained in writing from Marlite, deviation from these recommendations shall be at the risk of the installer(s).

Preparation: Building must be closed and HVAC systems operational and balanced. Concrete, paint drywall compounds and other sources of humidity must be dry and cured. Structural walls must be flat & true. A subwall surface is recommended, such as drywall, plywood or OSB. Vapor barriers are required between wall framing and subwall surface for exterior walls, to discourage warping. Direct, repetitive and continuous exposure to HVAC ventilation, extreme temperatures and/or direct sun exposure can result in a detrimental effect to the panels. Such conditions should be corrected before product installation. Except as approved by the manufacturer, most Marlite products should not be installed in high-humidity areas, such as kitchens, restrooms, showers & cold storage areas. Protect exposed floor & wall areas from damage with drop-cloths & rigid cardboard or plywood.

Conditioning: Panels must be allowed to equalize to the building conditions before installation. Acclimation in the installation area of at least 48 hr. is recommended. To ensure product performance, temperature range of 60-80° F and humidity range of 35-55% is recommended during storage, installation and product life cycle.

cont' on next page



Effective Date: 6/10/20

General Notes & Product Information (cont')

Handling: Open cartons and inspect all panels & hardware for damage. If material is found defective, notify Marlite immediately. Failure to do so will be at the sole risk of the installer(s). Store panels in a dry environment similar to final installation conditions. Store panels flat and off concrete floors. Color & texture variations may result from manufacturing techniques. Care must be taken during installation to check panel match before installing. Contact Marlite with questions.

Caution: Always wear eye protection and proper protective gear. Use proper safety guards on equipment during fabrication and installation. Note: Metal veneers & hardware can spark or produce sharp metal chips.

Tools: Regular carpentry tools, such as table, miter, circular & jig saws, sanding blocks & fine files, appropriate bubble level or laser level, chalk line, carpenter's square, etc. Use medium fine tooth carbide blades for cutting. When cutting solid phenolic panels, keep feed speed up to prevent blade overheating and damage.

Fabrication: Cut panels "face up" on a table saw or "face down" with a hand-held circular or jig saw. Use a sanding block or fine file to remove burrs or break sharp edges. Refinish exposed panel edges to match factory edges. NOTE! For all cutouts in HPL Panels, rounded inside corners (1/8" minimum radius) will minimize stress cracking. Trim & hardware are easily cut & mitered using carbide tipped blades in power miter and table saws. Pre-drilling of rim & hardware for attachment is not required if drill-tip screws are used. Where adhesive is needed, Marlite brand adhesives are required. Others may be substituted, Marlite approval. Follow manufacturer's use & clean-up recommendations for adhesives.

Clean-up: Most Marlite panels, trim & hardware are easily cleaned & maintained using a soft cloth and appropriate spray on cleaner or polish. Dampen cloth with cleaner. Don't over saturate cloth or not spray directly on products. To clean adhesive from most panels and all hardware & trim follow the adhesive manufacturer's recommendation. Always test any cleaner or thinner on a scrap piece of panel before proceeding.

For questions regarding product or installation issues, contact:
Marlite at 800-377-1221 or contact your local territory manager.

Installation Instructions

Statements expressed in this technical document are Marlite's recommendations for the application of our Sieva panel and trim system under normal conditions of installation. These recommendations represent our best judgment based on our experience with normal applications. Unless prior approval is obtained in writing from Marlite, any deviation from these recommended procedures shall be at the sole risk of the installer.

Important

It is the installer's responsibility to read and understand these installation instructions prior to installation. Contact Marlite at 1-800-377-1221 (toll free).

Inspection

Upon delivery carefully inspect all cartons, packages, pallets and protective wrap for damage or shortage. Open and inspect suspect packages, cartons or wrapped pallets for damage. Contact shipper immediately to report any damaged or missing materials. Failure to do so shall be at the sole risk of the installer. If defective materials are discovered, notify Marlite at 1-800-377-1221 immediately. Failure to do so shall be at the sole risk of the installer. Due to manufacturing techniques, some materials may exhibit slight variations in texture, color, consistency and pattern. This is considered normal.

Conditioning and Storage

Large Panels are wood fiber based, and like all wood products, subject to the effects of moisture, humidity and temperature. Panels should be stored flat and dry in a controlled environment and in the original shipping packs until ready for use. Before installation, panels should be acclimated to their final location for minimum of 48 hours. Partition walls are to be finished and the building completely closed. Walls shall be thoroughly dry and concrete cured and dry before starting installation. HVAC system must be operable and installation area must be balanced to normal operating conditions. Maintain environmental conditions (temperature, humidity, and ventilation) within limits recommended by manufacturer for optimum results. To ensure product performance, a temperature range of 60°-80°F (16°C-27°C) and a humidity range of 35-55% must be maintained during storage, installation and product life cycle. Do not install products under environmental conditions outside manufacturer's absolute limits.

Clean-up

Large Panels and trim are easily cleaned with a soft cloth, using spray furniture cleaner or polish. Follow instructions on Marlite's C-109 Adhesive package for adhesive clean-up. Always test solvents on a scrap part before proceeding. Do not oversaturate panel or trim faces or cloth with cleaning liquids. Contact Marlite at 1-800-377-1221 with questions.

Large Panel Fabrication

Panel Sizes

Marlite's Large Panels are supplied in four sizes:

2'x10' (nominal)

4'x10' (nominal)

2'x8' (nominal)

4'x8' (nominal)

Panels are typically supplied with an 1/8" wide kerf centered along each edge.

Field fabrication is required for sizes other than listed.

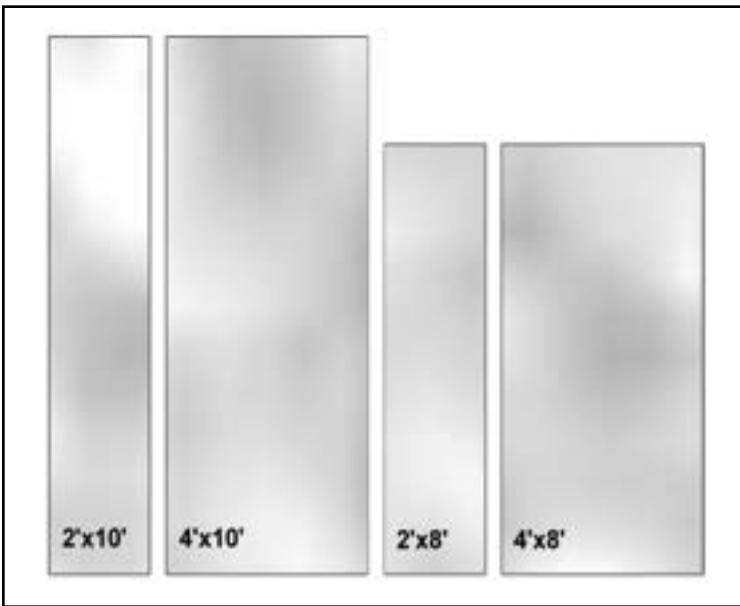

Panel Cutting

Sieva panels are easily cut to fit field condition.

Cut "face up" when using a table saw.

Cut "face down" when using a circular saw. Pad support surfaces if cutting face down.

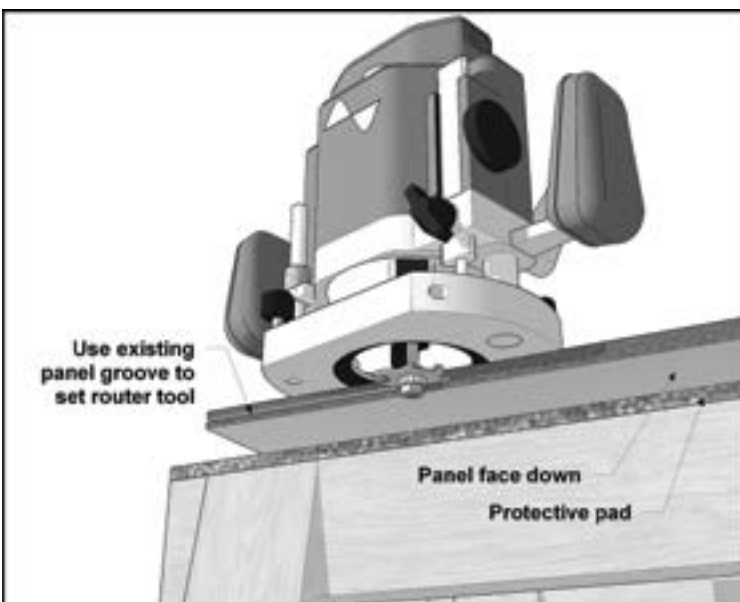
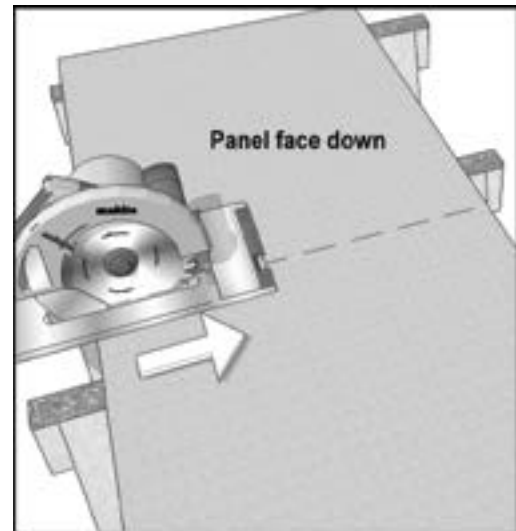
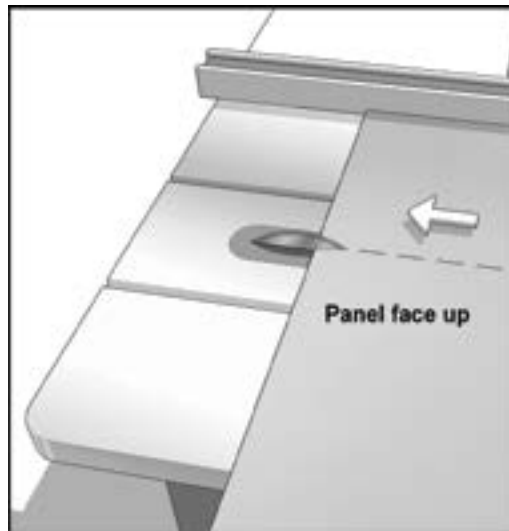

Re-kerfing Edge

After cutting panels to size, it may be necessary to groove or "re-kerf" the edge to accommodate reveal hardware. The kerf is 1/8" wide and can be made using a hand-held router with the appropriate bit. Kerf depth and router set-up should be checked by matching to a factory kerfed edge.

Router bits for the kerf can be ordered from Marlite and shipped with your Large Panel order. Or contact Marlite toll free @ 1-800-377-1221 to order additional router bits.

GENERAL NOTE! NEMA LD-3 SECTION A.7

TYPICAL PROBLEMS- CAUSES AND PREVENTION

- A. Stress cracking - Cracking of the laminate at corners and around cutouts (see Figure A-9) may be caused by improper fabrication during installation. Rough edges, inside corners that have not been radiused, and forced fits can cause cracking. Radiusing all edges and inside corners as large as possible 3 mm (1/8 in.) minimum will minimize stress cracking. A radiused corner created by a 6 mm (1/4 in.) diameter router bit is normally used.

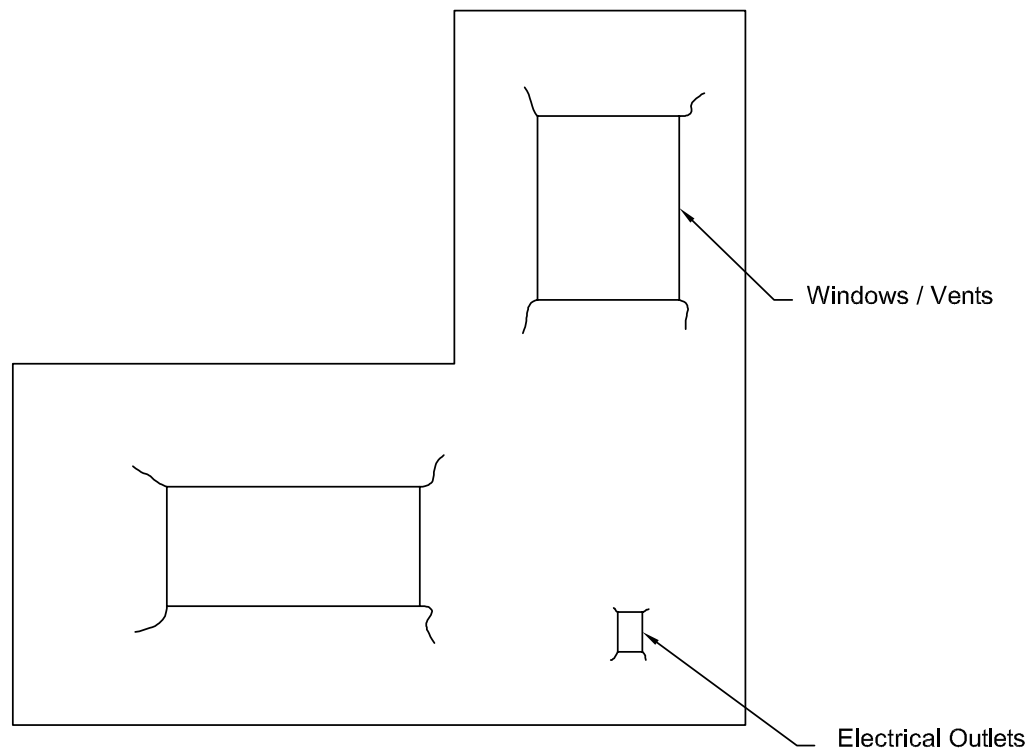
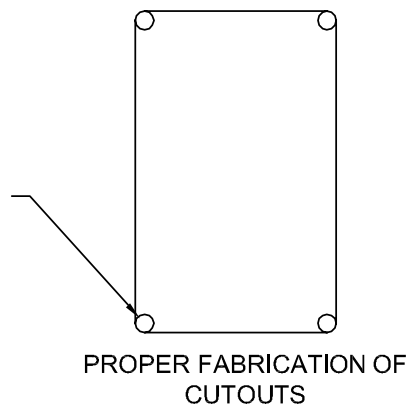

FIGURE A-9
CRACKING OF LAMINATE

NOTE! To help prevent stress cracking of the laminate, pre-drill all four corners using a 1/4 " bit. Do not square the corners.



D1 - Large Panel Bottom Edge Details

Notes:

Vertical reveals may require notching to clear horizontal edge trim.

Cut back min. 3/4" to clear edge trim flange where shown in the illustrations.

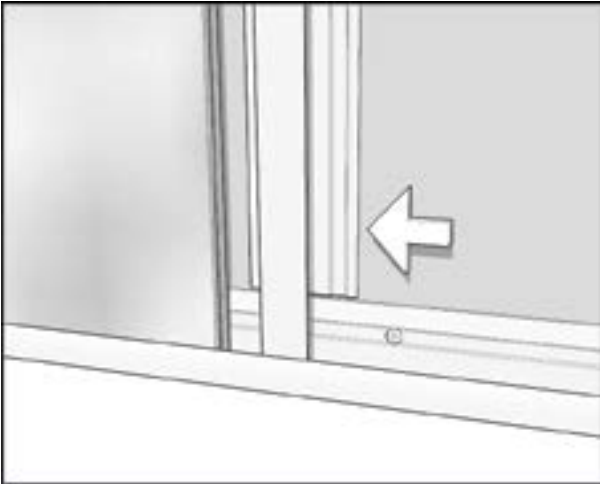

D1.1
Vertical CP-3 @ CP-270 Edge Trim
Notch CP-3 to clear CP-270 flange

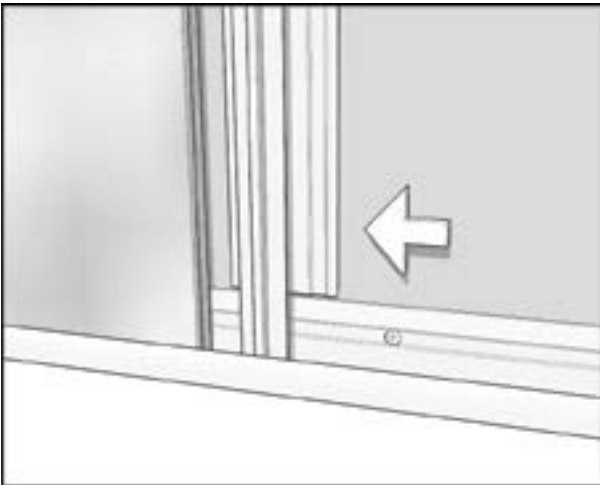

D1.3
Vertical CP-6 @ CP-270 Edge Trim
Notch CP-6 to clear CP-270 flange

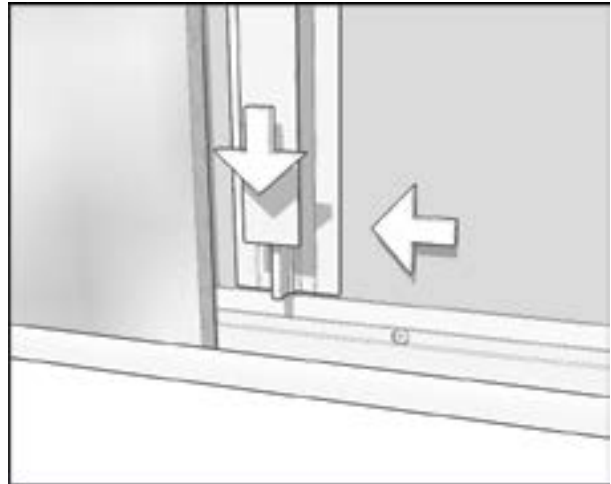

D1.2
Vertical CP-4 @ CP-270 Edge Trim

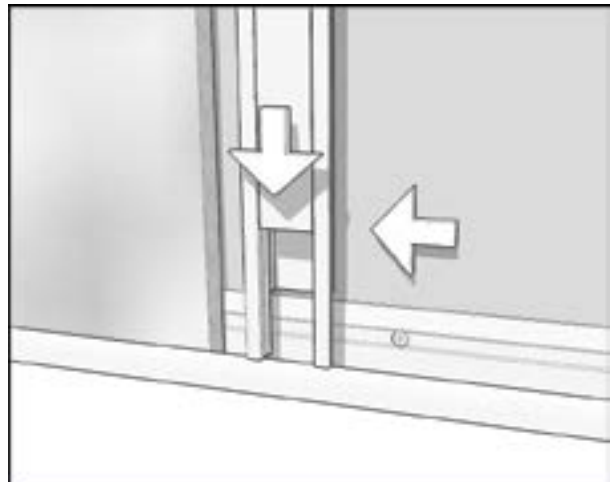

D1.4
Vertical CP-7 @ CP-270 Edge Trim
Notch CP-7 to clear CP-270 flange

D2 - Large Panel Top Edge Details

Notes:

Vertical reveals may require notching to clear horizontal edge trim.

Cut back min. 3/4" to clear edge trim flange where shown in the illustrations.

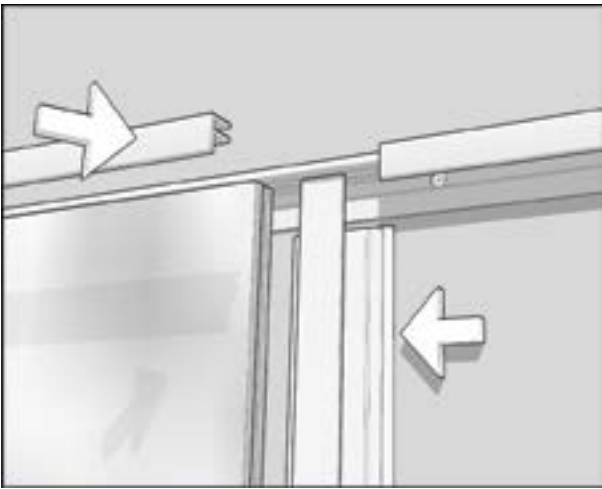

D2.1

Vertical CP-3 @ CP-280 Edge Trim
Notch CP-3 to clear CP-280 flange

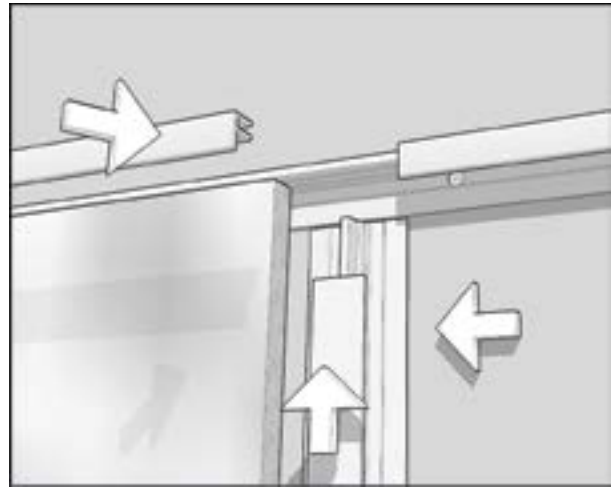

D2.2

Vertical CP-4 @ CP-280 Edge Trim

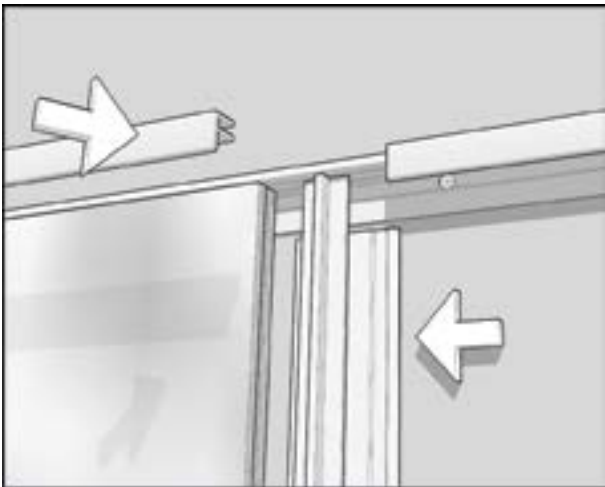

D2.3

Vertical CP-6 @ CP-280 Edge Trim
Notch CP-6 to clear CP-280 flange

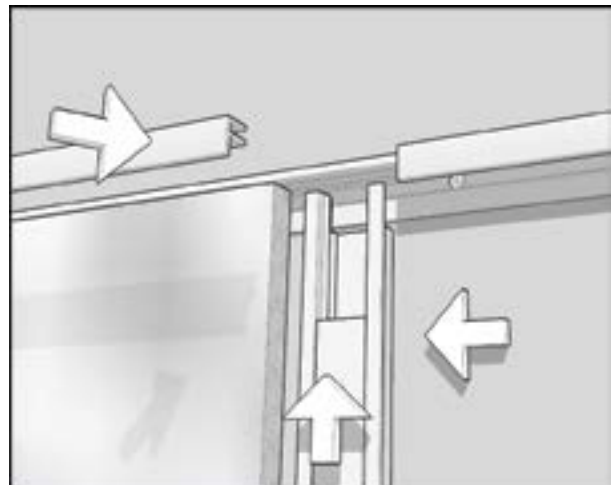

D2.4

Vertical CP-7 @ CP-280 Edge Trim
Notch CP-7 to clear CP-280 flange

D3 - Large Panel Inside Corner Details

Notes:

Horizontal reveals will require notching to clear vertical trim.

Cut back 1" to clear vertical trim flange as shown in the illustrations.

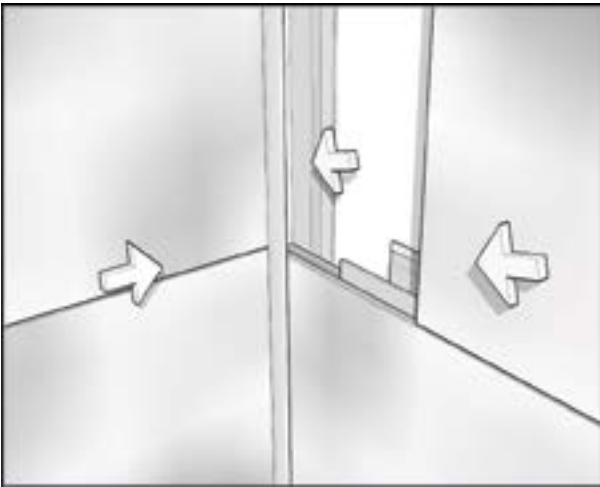

D3.1
Horizontal CP-3 @ CP-270 Inside Corner
Notch CP-3 to clear CP-270 flange

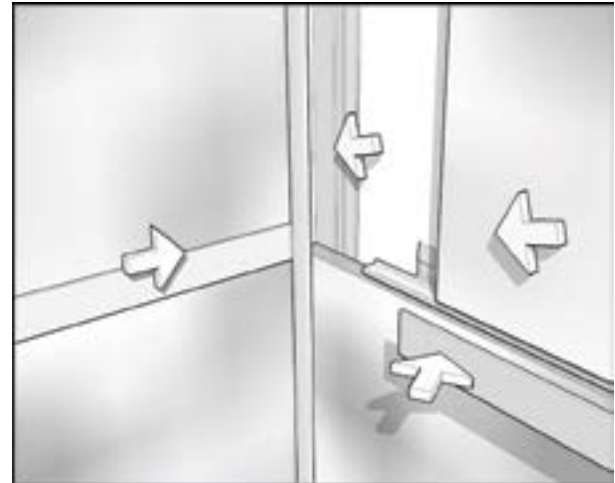
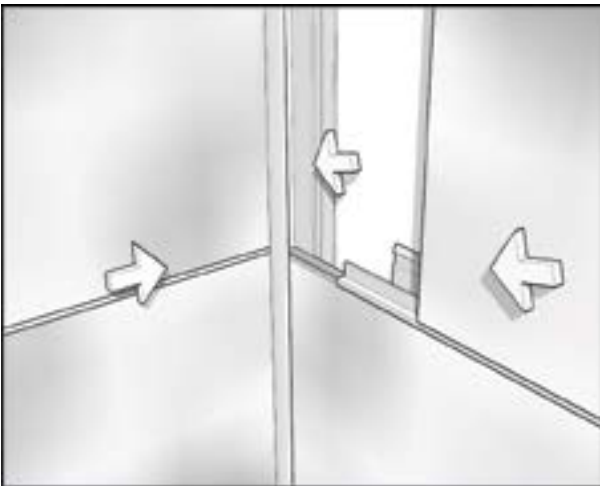

D3.2
Horizontal CP-4 @ CP-270 Inside Corner
Notch CP-4 to clear CP-270 flange

D3.3
Horizontal CP-6 @ CP-270 Inside Corner
Notch CP-6 to clear CP-270 flange

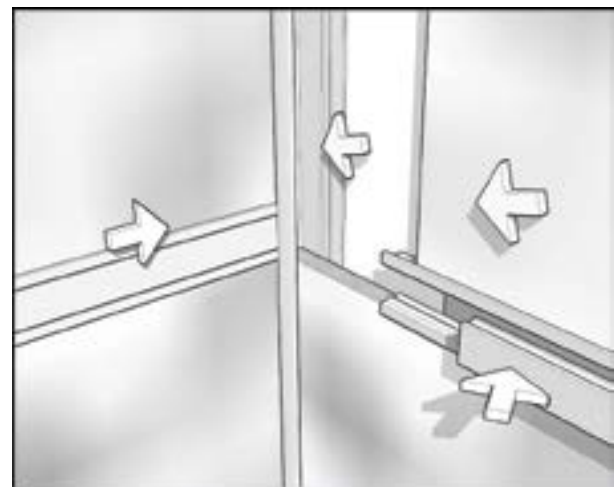
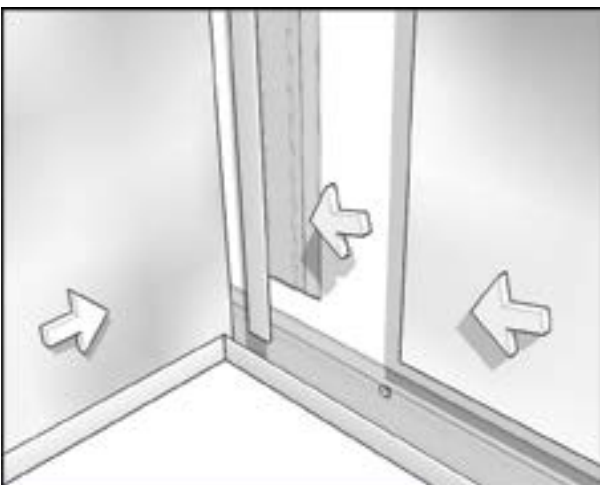

D3.4
Horizontal CP-7 @ CP-270 Inside Corner
Notch CP-7 to clear CP-270 flange

D3.5
CP-270 Edges @ CP-270 Inside Corner
Notch vertical CP-270 to clear CP-270 flange

D4 - Large Panel Outside Corner Details

Notes:

Horizontal reveals will require notching to clear vertical trim.

Cut back 1 1/2" to clear vertical trim flange as shown in the illustrations.

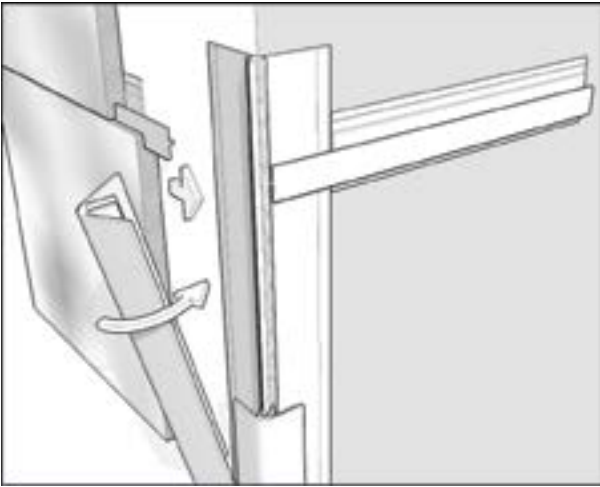

D4.1
Horizontal CP-3 @ CP-90 Outside Corner
Notch CP-3 to clear CP-90 flange

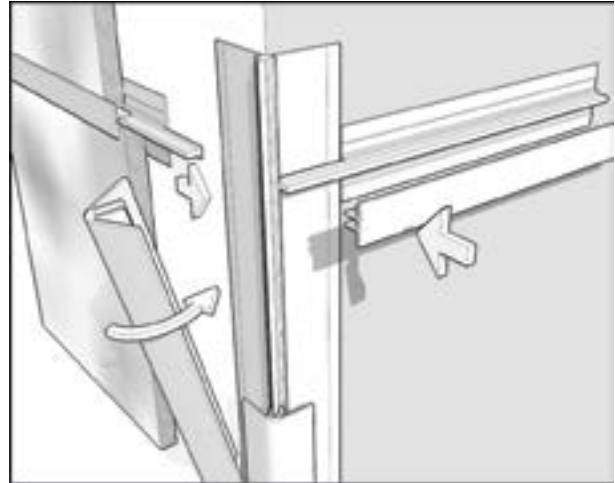

D4.2
Horizontal CP-4 @ CP-90 Outside Corner
Notch CP-4 to clear CP-90 flange

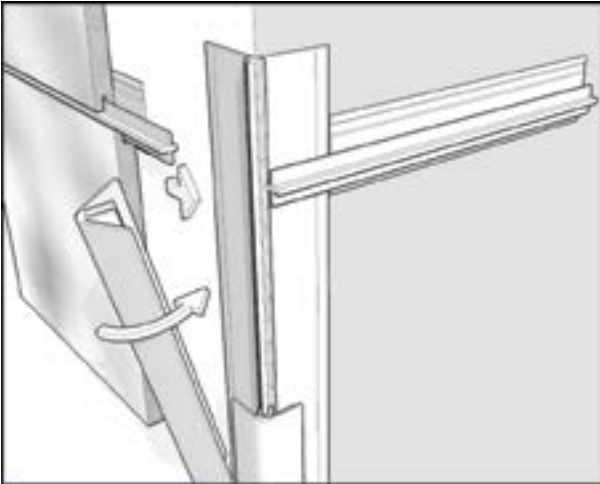

D4.3
Horizontal CP-6 @ CP-90 Outside Corner
Notch CP-6 to clear CP-90 flange

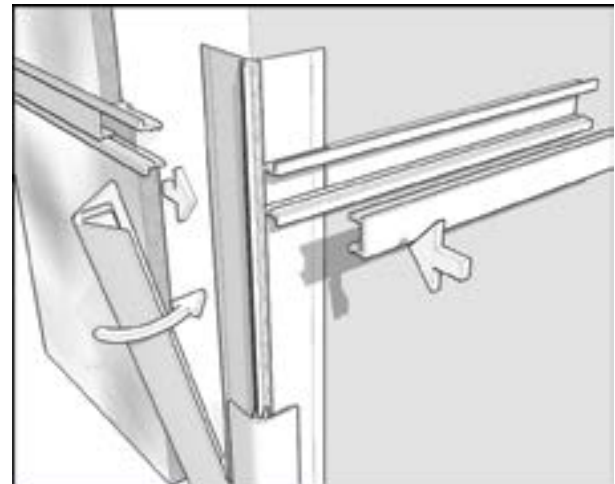

D4.4
Horizontal CP-7 @ CP-90 Outside Corner
Notch CP-7 to clear CP-90 flange

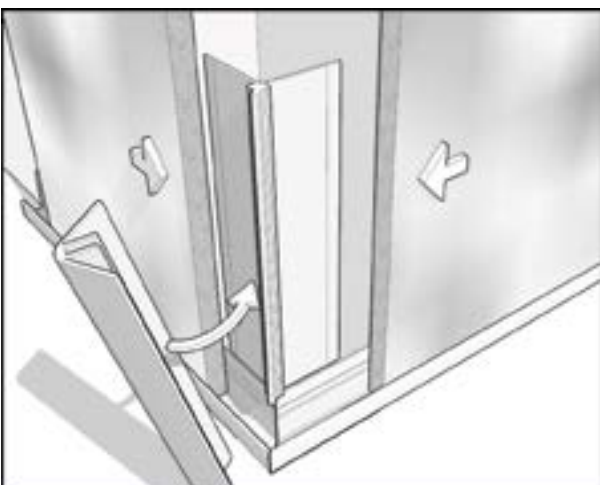

D4.5
CP-270 Edges @ CP-90 Outside Corner
Butt CP-90 retainer to edge of CP-270 flanges

D5 - Large Panel Reveal Intersection Details

Notes:

Vertical reveals may require notching to clear horizontal reveal flanges.

Cut back min. 3/4" to clear reveal flange where shown in the illustrations.

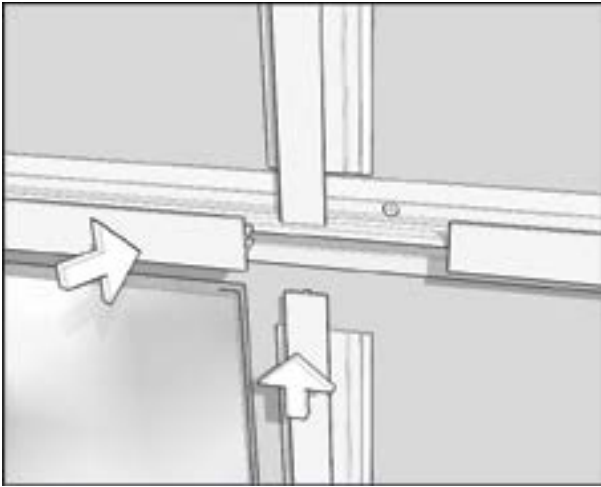

D5.1
Horizontal CP-4 @ Vertical CP-3
Notch CP-3 to clear CP-4 flange

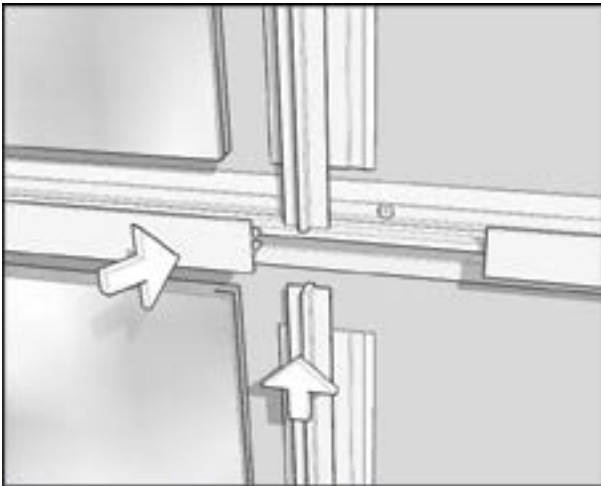

D5.2
Horizontal CP-4 @ Vertical CP-4
Butt vert. CP-4 retainer to horiz. CP-4 flange

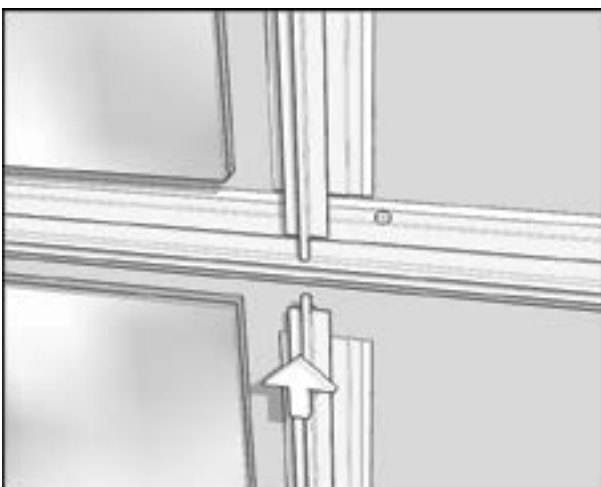

D5.3
Horizontal CP-4 @ Vertical CP-6
Notch CP-6 to clear CP-4 flange

D5.5
Horizontal CP-6 @ Vertical CP-6
Notch CP-6 to clear CP-6 flange and spline

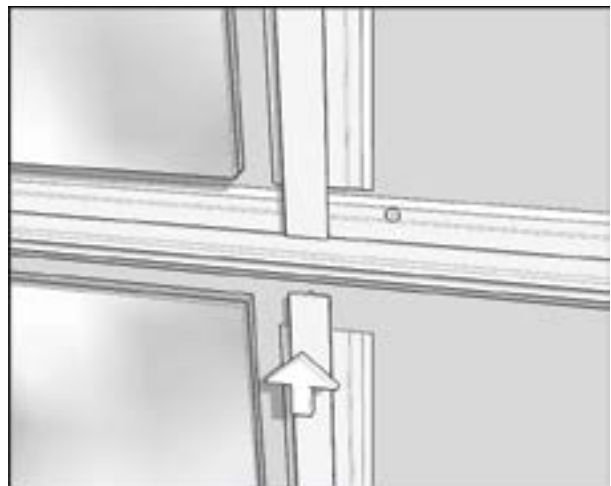

D5.4
Horizontal CP-6 @ Vertical CP-3
Notch CP-3 to clear CP-6 flange

D6 - Large Panel Reveal Intersection Details

Notes:

Vertical reveals may require notching to clear horizontal reveal flanges.

Cut back min. 3/4" to clear reveal flange where shown in the illustrations.

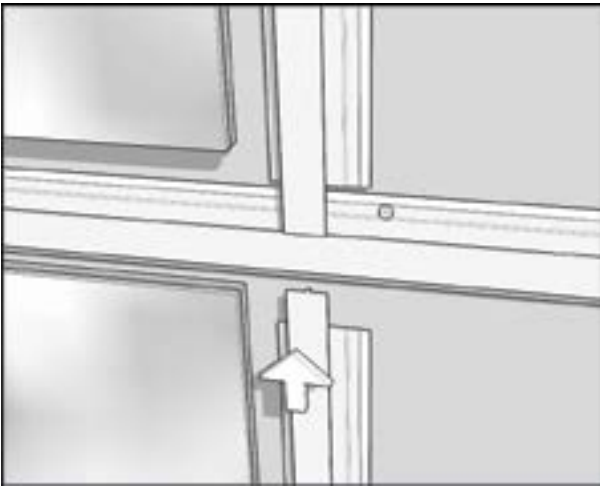

D6.1
Horizontal CP-3 @ Vertical CP-3
Notch CP-3 to clear CP-3 flange

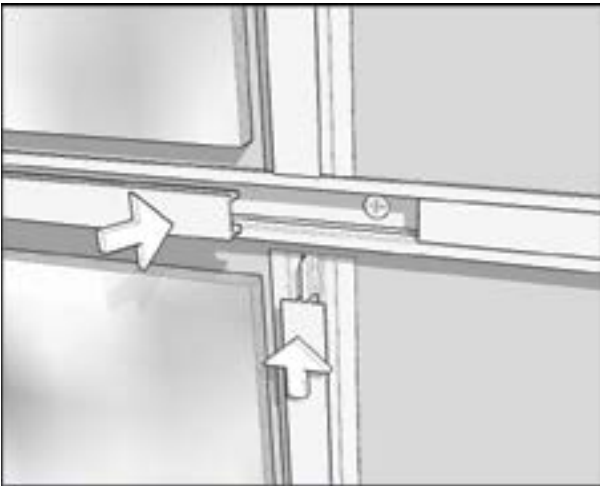

D6.3
Horizontal CP-7 @ Vertical CP-4
Butt CP-4 to CP-7

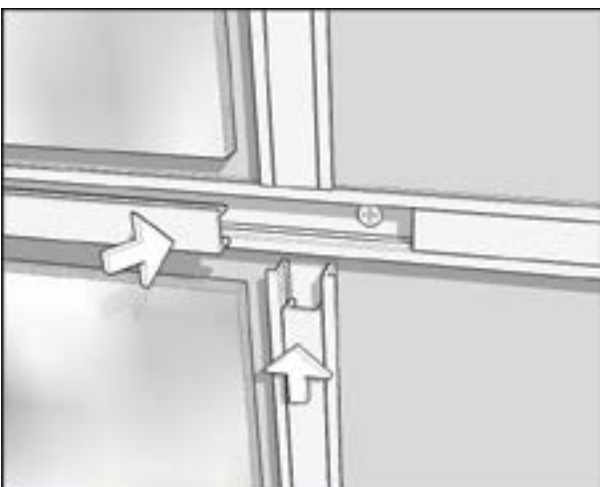

D6.5
Horizontal CP-6 @ Vertical CP-6
Butt CP-7 to CP-7

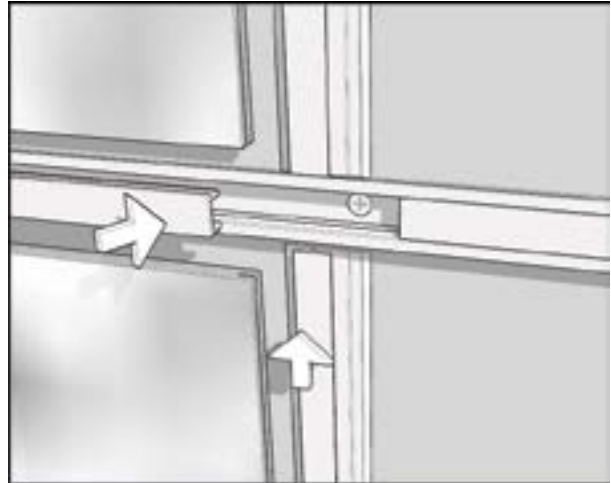

D6.2
Horizontal CP-7 @ Vertical CP-3
Butt CP-3 to CP-7

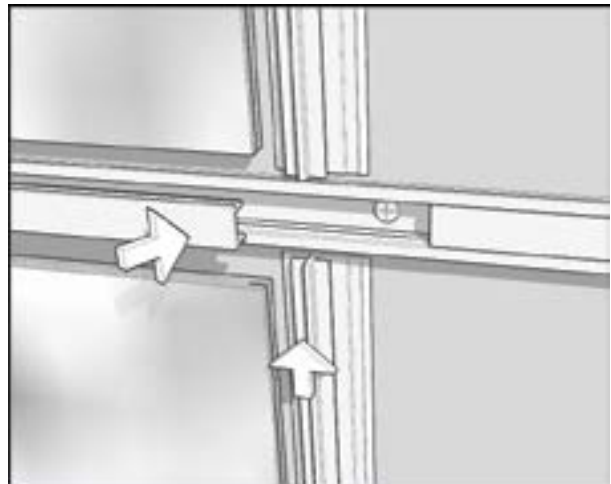

D6.4
Horizontal CP-7 @ Vertical CP-6
Butt CP-6 to CP-7

Large Panel System Installation - 1

Before proceeding, read and understand all installation instructions and details. No installation instructions can cover every field condition, therefore installers are expected to have reasonable knowledge and tools to interpret and adapt these instructions to varying field conditions and situations. Questions and concerns regarding special conditions can be directed to Marlite, (toll free) 1-800-377-1221.

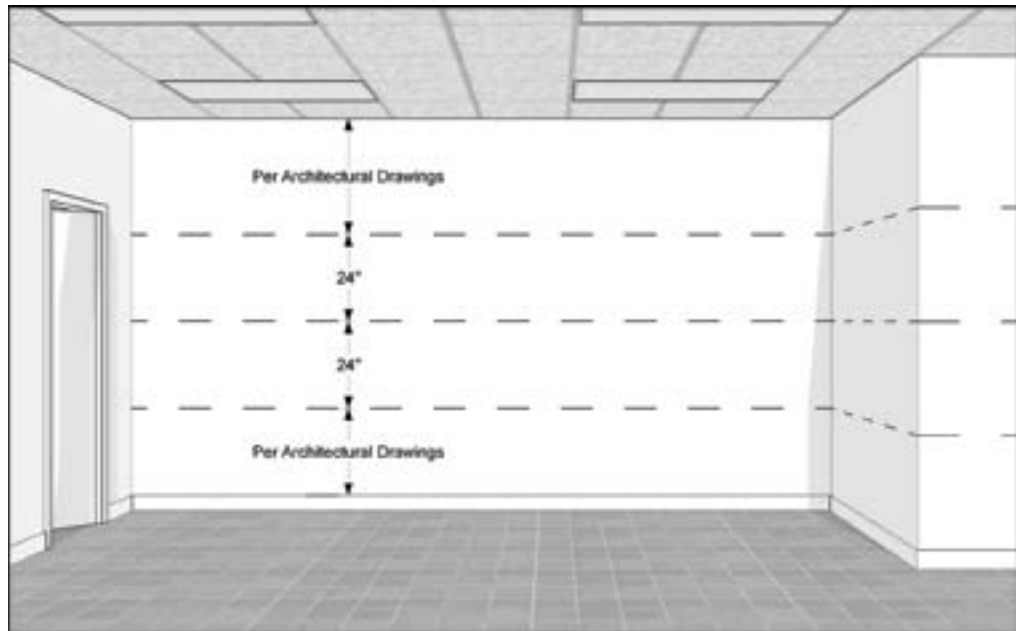

Step 1 - Layout

Refer to architectural drawings for panel and trim layout. Unless otherwise noted, try to align horizontals with door, window or corridor openings. Mark stud locations for full height and area of installation.

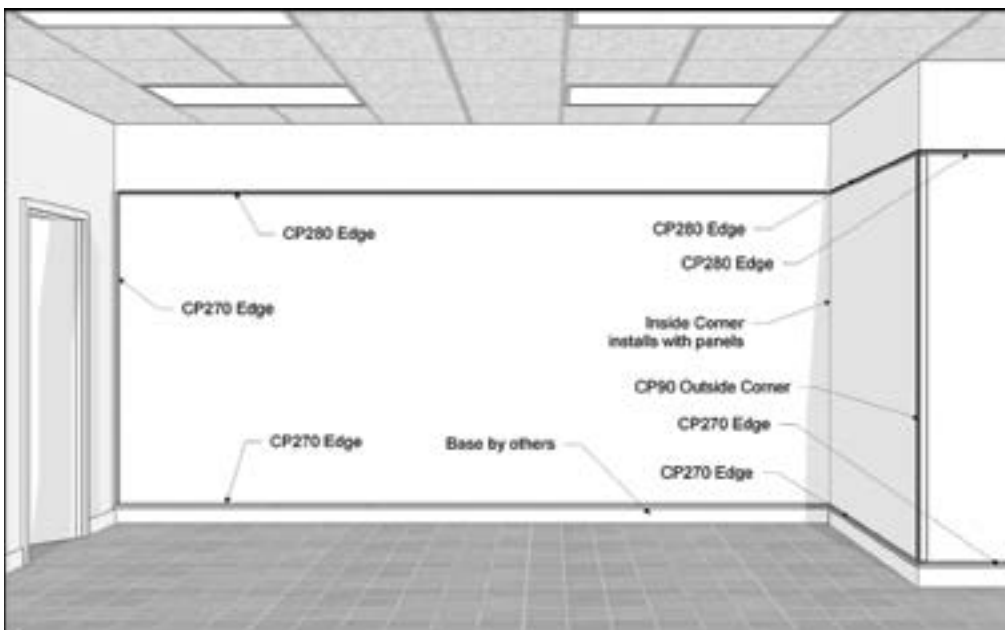

Step 2 - Install Perimeter Trim

Install bottom Edge trim first, followed by other edge and outside corner trim. Inside corners are installed as walls are completed. See D3 - Inside Corner Details, page 5. Attach trim to studs with bugle-head drywall screws, or Marlite C-109 Adhesive where studs are not available. Trim will require mitering or notching to fit at most conditions. See D3 - Inside Corner Details, page 5 & D4 - Outside Corner Details, page 6.

Large Panel System Installation - 2

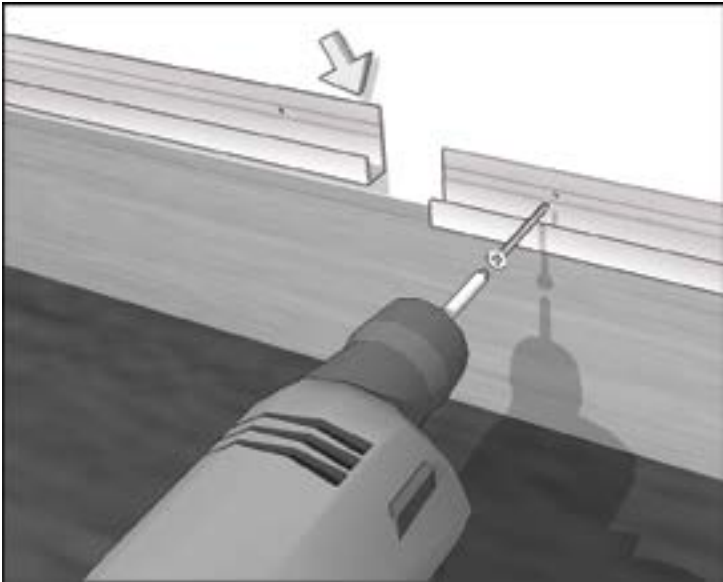

Step 3 - Install Bottom Edge

Pre-drill the bottom CP-270 Edge trim at stud location. Use bugle-head drywall screws into studs to attach the trim. Where studs aren't available, use Marlite C-109 Adhesive to attach trim. Painter's tape can be used to hold the trim until the adhesive sets.

Step 4 - Apply Adhesive to Panels
Note: Dry fit and cut panels before applying adhesive. Read all instructions and warnings on the adhesive container before proceeding.

Apply Marlite C-109 Adhesive around the perimeter of the panels, keeping it in about 1" to make handling easier. Add lines of adhesive every 6"-8" across the rest of the panels, as shown at right.

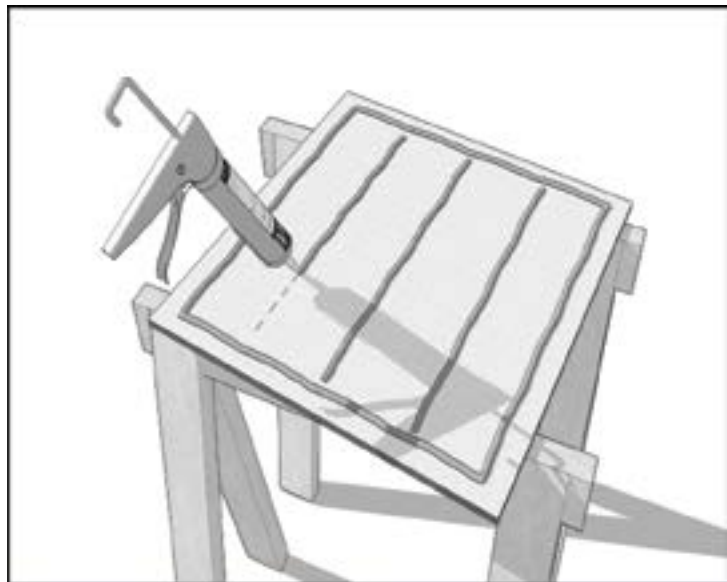

Step 5 - Install Panels & Reveals

Install panels and vertical reveal hardware. Add C-109 adhesive to the back of the reveal hardware when installing to help keep it in place as the next panel is set.

Vertical reveal hardware may be different than shown and may require notching to clear the CP-270 Edge trim flange. See D1 - Bottom Edge Details, page 3.

Large Panel System Installation - 3

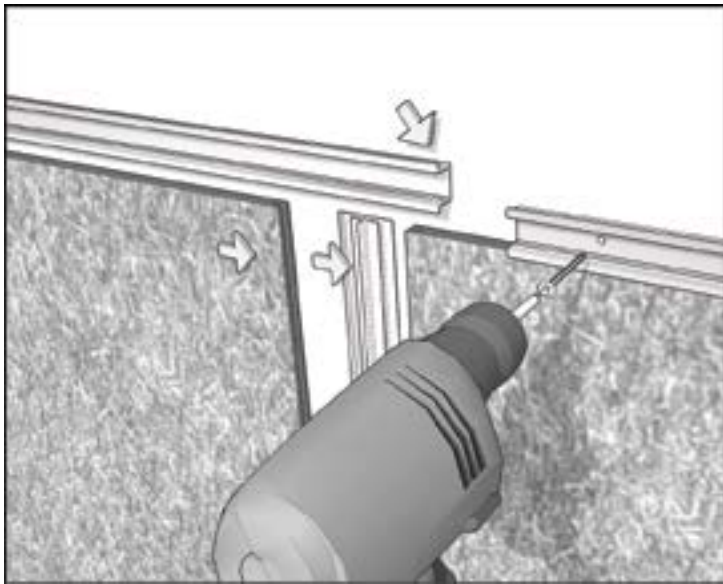

Step 6 - Horizontal Reveals

Attach horizontal reveal hardware by pre-drilling and using bugle-head drywall screws.

Horizontal and vertical reveal hardware may be different than shown. Vertical hardware may require notching to fit. See D5 & D6 - Reveal Intersection Details, pg. 7-8.

Step 7 -Continue Installation

Continue installing panels and reveal hardware.

Note: Some reveal profiles may be specified with battens or reveal inserts. Use Marlite C-109 Adhesive to attach battens and inserts after a wall elevation is complete. Painter's tape can be used to hold them until the adhesive sets.

Horizontal and vertical reveal hardware may be different than shown. Vertical hardware may require notching to fit. See D5 & D6 - Reveal Intersection Details, pg. 7-8.

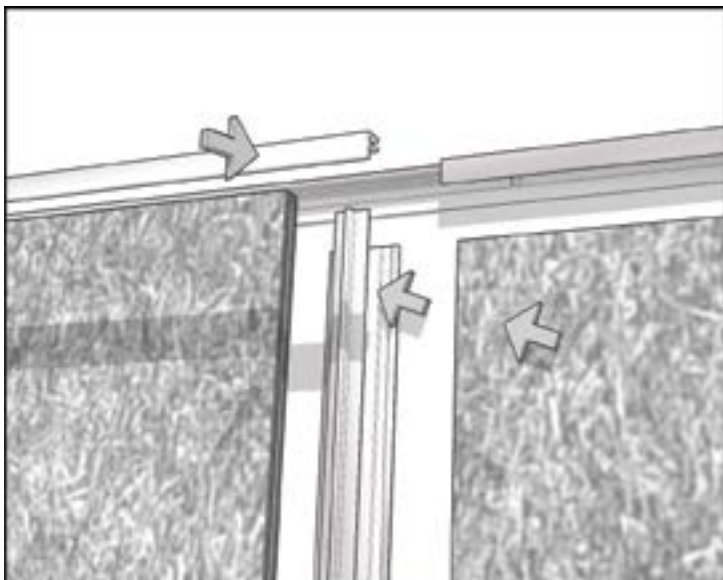
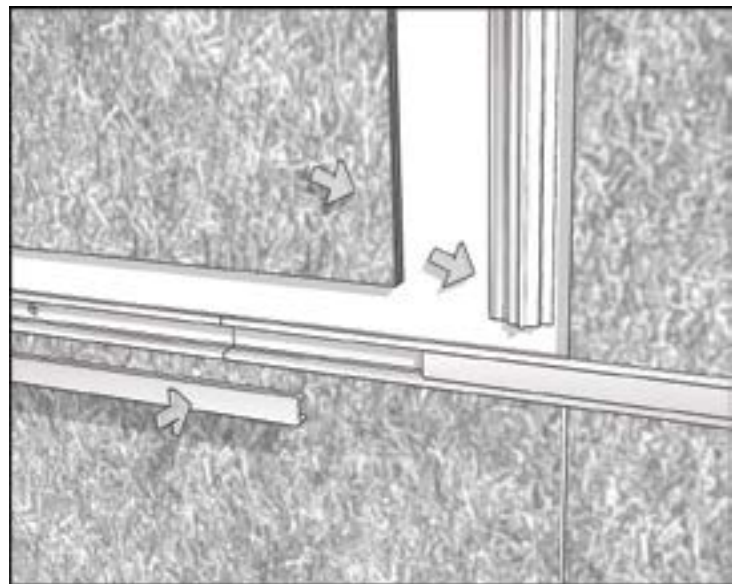

Step 8 - Top Edge Trim

Use the CP-280 2-piece Edge Trim at the the top of the installation.

Reveal hardware may be different than shown and may require notching to clear CP-280 flange. See D2 - Top Edge Details, page 4.

Large Panel System Installation - 4

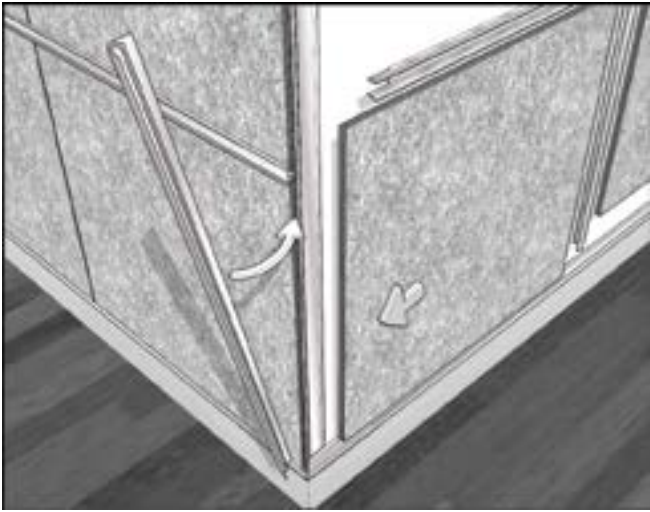

Step 9 - Outside Corners

At outside corners, use the CP-90 2-piece Outside Corner Trim. Attach the corner backer profile. Leave a 1/16" gap at the outside corner backer when installing panels and reveals to allow for expansion. Use Marlite C-109 Adhesive to install the CP-90 Corner cap after the panels and reveals are done. Painter's tape can be used to hold it in place until the adhesive sets. Horizontal reveal hardware may be different than shown and may require notching to clear the CP-270 Edge trim flange. See D4 - Outside Corner Details, page 6.

Step 10 - Inside Corners

At inside corners, complete a full wall installation before installing the inside corner and starting the next wall. Use the CP-270 Edge Trim for Inside Corner trim. Horizontal reveal hardware may be different than shown and may require notching to clear the CP-270 Edge trim flange. See D3 - Inside Corner Details, page 5.

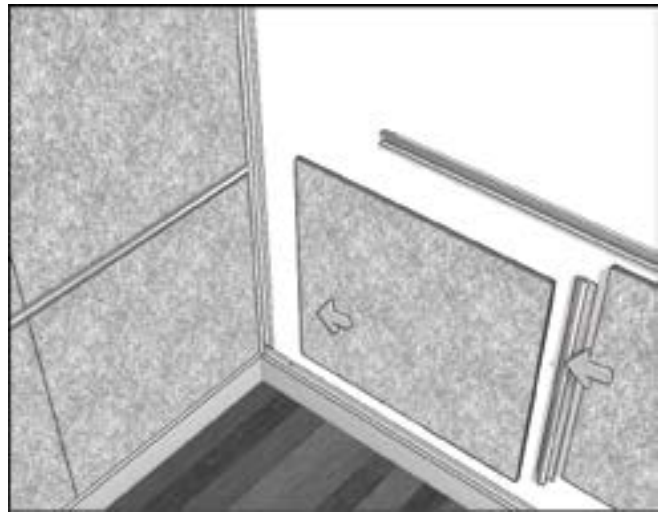

Step 11- Finished Installation



This page is intentionally left blank.



1 Marlite Drive, Dover, OH 44622
1-800-377-1221
info@marlite.com