

**Member Designator 250SLTSLP250-33**

Coating G60, CP60

**Physical Properties**

Design Thickness 0.0329 in  
 Mil 33 mil  
 Gauge 20 Gauge  
 Web Width 2.50 in  
 Leg Height 2.50 in  
 Distance between slots 1.00 in  
 Slot Widths 0.230 in  
 Yield Strength 33 ksi  
 Weight Per Foot 0.834 lb/ft

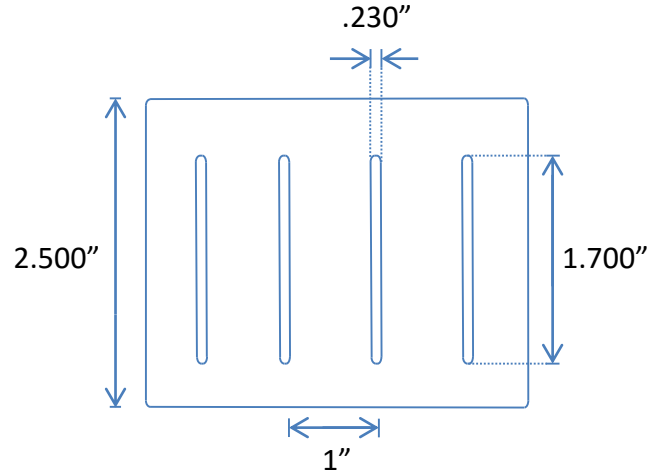

**Gauge Offering**

Available in 25ga, 20ga, 20Sga, 18ga, 16ga, and 14ga

**Web Width Offering**

2-1/2", 3-5/8", 4", 6" and 8" widths

**Standard Length**

10'-0"

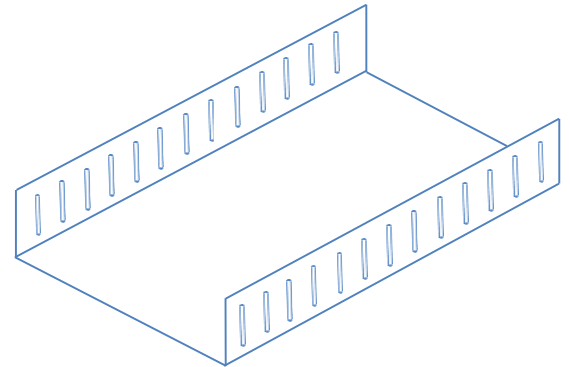

**General Notes**

1. Calculated properties are based on AISI S100-16, North American Specification for Design of Cold-Formed Steel Structural Members and AISI S240-15, North American Standard for Cold-Formed Steel Framing - Nonstructural Members.
2. Drywall framing members have a protective coating conforming to ASTM spec A 653/A 653M, G-40 min, or equivalent corrosion resistance.
3. All structural framing members have a protective coating conforming to ASTM C 955.
4. Reference ASTM specification A 1003/A 1003 M table 1 for the universe of allowable coatings for light gauge steel framing.
5. All delivered material must be kept dry, preferably by being stored inside a building under a roof. If it is necessary to store material outside, it must be stacked off the ground, properly supported on a level platform, and fully protected from the weather. Reference ASTM C 754 section 8 and ASTM C 1007 section 4.
6. Drywall framing [nonstructural 25 gauge, 22 gauge and 20 gauge] is not permitted in load bearing (i.e. axial load greater than 200 lbs.) or exterior applications (i.e. transverse load greater than 10 PSF). Reference ASTM C 645 section 3.2.2.
7. Track is produced in standard lengths of 10 feet unless a custom track length is indicated. Track is manufactured with unpunched webs.

**LEED Green Building Credits**

MR Credit 2: Construction Waste Management – MBA steel framing is 100% recyclable.  
 MR Credit 4: Recycled Content – MBA steel framing is formed from no less than 25.5% post-consumer and 6.8% pre-consumer recycled content.  
 MR Credit 5: Regional Materials – MBA has manufacturing facilities in multiple states.