

Member Designator 600SLTSLP250-54

Coating G60, CP60

Physical Properties

Design Thickness 0.0566 in
 Mil 54 mil
 Gauge 16 Gauge
 Web Width 6.00 in
 Leg Height 2.50 in
 Distance between slots 1.00 in
 Slot Widths 0.230 in
 Yield Strength 50 ksi
 Weight Per Foot 2.114 lb/ft

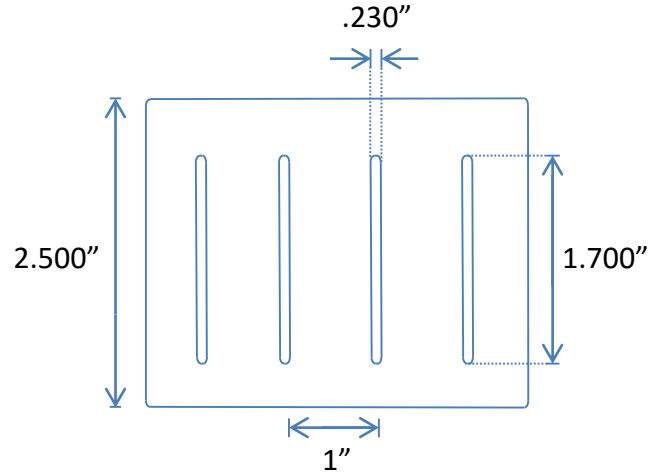

Gauge Offering

Available in 25ga, 20ga, 20Sga, 18ga, 16ga, and 14ga

Web Width Offering

2-1/2", 3-5/8", 4", 6" and 8" widths

Standard Length

10'-0"

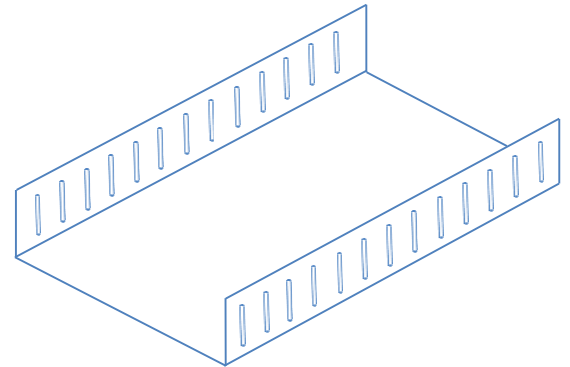

General Notes

1. Calculated properties are based on AISI S100-16, North American Specification for Design of Cold-Formed Steel Structural Members and AISI S240-15, North American Standard for Cold-Formed Steel Framing - Nonstructural Members.
2. Drywall framing members have a protective coating conforming to ASTM spec A 653/A 653M, G-40 min, or equivalent corrosion resistance.
3. All structural framing members have a protective coating conforming to ASTM C 955.
4. Reference ASTM specification A 1003/A 1003 M table 1 for the universe of allowable coatings for light gauge steel framing.
5. All delivered material must be kept dry, preferably by being stored inside a building under a roof. If it is necessary to store material outside, it must be stacked off the ground, properly supported on a level platform, and fully protected from the weather. Reference ASTM C 754 section 8 and ASTM C 1007 section 4.
6. Drywall framing [nonstructural 25 gauge, 22 gauge and 20 gauge] is not permitted in load bearing (i.e. axial load greater than 200 lbs.) or exterior applications (i.e. transverse load greater than 10 PSF). Reference ASTM C 645 section 3.2.2.
7. Track is produced in standard lengths of 10 feet unless a custom track length is indicated. Track is manufactured with unpunched webs.

LEED Green Building Credits

MR Credit 2: Construction Waste Management – MBA steel framing is 100% recyclable.
 MR Credit 4: Recycled Content – MBA steel framing is formed from no less than 25.5% post-consumer and 6.8% pre-consumer recycled content.
 MR Credit 5: Regional Materials – MBA has manufacturing facilities in multiple states.