

Member Designator **400WS775-68**
 Coating CP60

Physical Properties

Design Thickness 0.0713 in
 Mil 68 mil
 Gauge 14 Gauge
 Web Width 4.00 in
 Leg Length 1.25 in
 Yield Strength 33 ksi
 Weight Per Foot 0.941 lb/ft

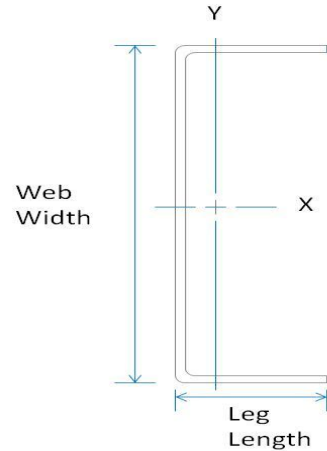

Thickness (mils)	Gauge	Length
68	14	3-3/8", 5-3/4", 7-3/4" 9-3/4", 11-3/4", 13-3/4" or custom
or custom	or custom	

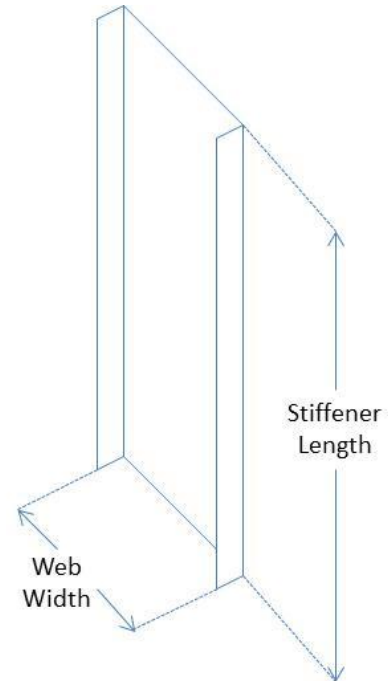

General Notes

- Physical properties and load tables have been calculated in conformance with the 2001 NASPEC for the Design of Cold-Formed Steel Structural Members, including the 2004 Supplement, and the IBC 2006, unless noted otherwise.
- All structural framing members have a protective coating conforming to ASTM C 955.
- Reference ASTM specification A 1003/A 1003 M table 1 for the universe of allowable coatings for light gauge steel framing.
- Stud/joists are manufactured to custom lengths. Stud/joists are manufactured with punched webs unless otherwise specified at time of order.
- Track is produced in standard lengths of 10 feet unless a custom track length is indicated. Track is manufactured with unpunched webs.
- Structural framing members are marked with product information per the requirements of ASTM C 955 section 12.
- All delivered material must be kept dry, preferably by being stored inside a building under a roof. If it is necessary to store material outside, it must be stacked off the ground, properly supported on a level platform, and fully protected from the weather. Reference ASTM C 754 section 8 and ASTM C 1007 section 4.

LEED Green Building Credits

- MR Credit 2: Construction Waste Management – MBA steel framing is 100% recyclable.
 MR Credit 4: Recycled Content – MBA steel framing is formed from no less than 25.5% post-consumer and 6.8% pre-consumer recycled content.
 MR Credit 5: Regional Materials – MBA has manufacturing facilities at multiple locations.