

MAXI-BATTEN

Condensed
Technical
Reference

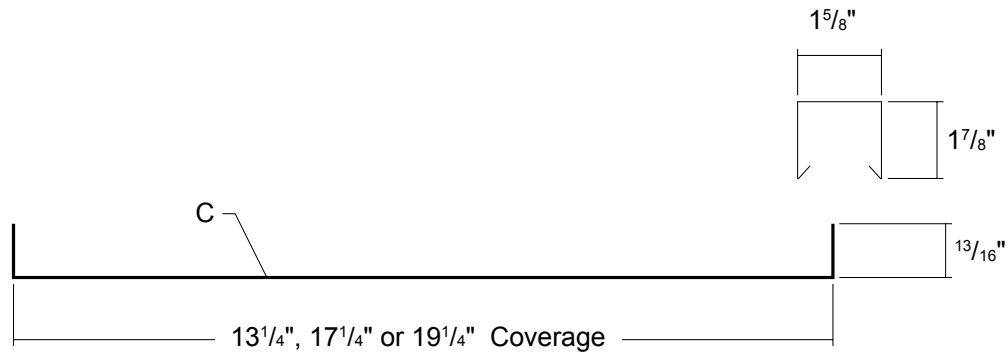

ARCHITECTURAL
PANEL

CONCEALED
FASTENED

13 1/4", 17 1/4"
OR 19 1/4"
COVERAGE

MINIMUM
SLOPE
3:12

SOLID
SUBSTRATE

PANEL OVERVIEW

- ▶ Finishes: PVDF, MS Colorfast45[®] and Acrylic-Coated Galvalume[®]
- ▶ Corrosion Protection: AZ55 per ASTM A 792 for unpainted Galvalume[®]
AZ50 per ASTM A 792 for painted Galvalume[®]
G90 per ASTM A 653 for Galvanized
- ▶ Thickness: Standard: 26 ga and 24 ga; Optional: 22 ga and 0.032" aluminum
- ▶ 13 1/4", 17 1/4" or 19 1/4" panel coverage, Wide Batten Cap: 1 5/8" x 1 7/8"
- ▶ Panel Length: Minimum: 5'; Maximum: 45' recommended
- ▶ Architectural standing rib roof system
- ▶ Minimum roof slope: 3:12
- ▶ Applies over solid substrate with minimum 30# felt underlayment

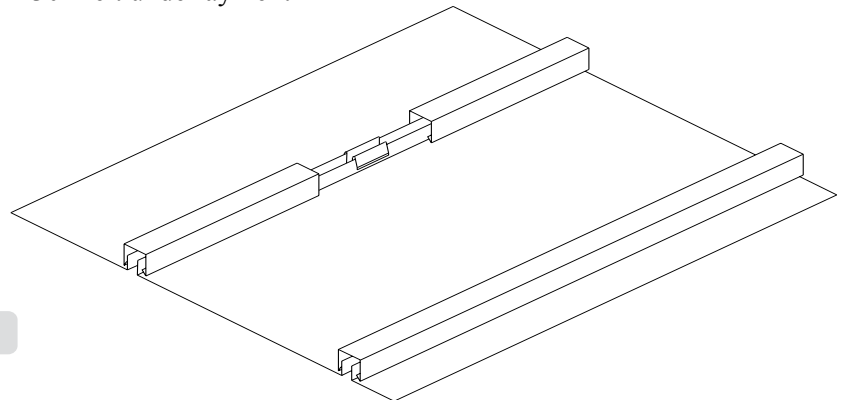

TESTING AND APPROVALS

- ▶ UL 2218 Impact Resistance - Class 4
- ▶ UL 790 Fire Resistance Rating - Class A, per building code
- ▶ UL 263 Fire Resistance Rating - per assembly
- ▶ UL 580 Uplift Resistance - Class 90 Constructions:
 - Over plywood: #398
 - Over metal deck: #398A
- ▶ ASTM E 283 Air Leakage
- ▶ ASTM E 331 Water Penetration

ms metal sales[™]
manufacturing corporation

MAXI-BATTEN

Condensed
Technical
Reference

ATTACHMENT DETAIL

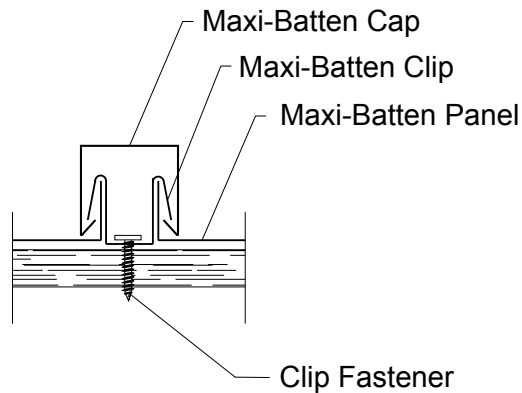

PANEL CLIP

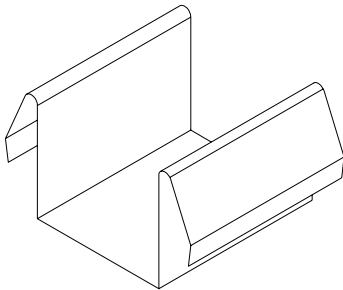

BASIC INSTALLATION

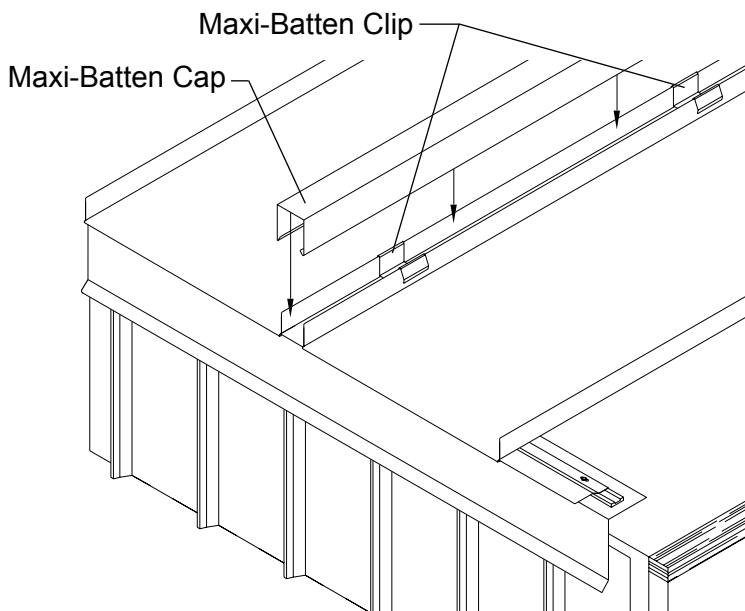

FASTENING INFORMATION

► Clips

Clip spacing is based upon the design loads, the spanning capacity of the panels, the fasteners and the support members.

Clips are 0.030" thick, G90 galvanized.

Clips can accommodate thermal expansion and contraction.

► Fasteners

Overdriven fasteners will cause panel distortions.

Fasteners should extend 1/2" or more past the inside face of the support material.

Clip Fasteners:

Over wood deck: #10-12 Pancake Head Wood Screw

Over metal deck: #14-13Deck Screw

Concealed End Fastener:

Over wood deck: #10-12 Pancake Head Wood Screw

Over metal deck: #14-13Deck Screw

Trim Fasteners:

1/4"-14 x 7/8" XL Stitch Screw

1/8" x 3/16" Pop Rivet

ms metal sales[™]
manufacturing corporation

metalsales.us.com

Anchorage, AK 866.640.7663
Bay City, MI 888.777.7640
Deer Lake, PA 800.544.2577
Denver, CO 800.289.7663

Detroit Lakes, MN 888.594.1394
Fontana, CA 800.782.7953
Fort Smith, AR 877.452.3915
Independence, MO 800.747.0012

Jacksonville, FL 800.394.4419
Jefferson, OH 800.321.5833
Mocksville, NC 800.228.6119
Nashville, TN 800.251.8508
Rock Island, IL 800.747.1206
Rogers, MN 800.328.9316

Seattle, WA 800.431.3470
Sellersburg, IN 800.999.7777
Sioux Falls, SD 888.299.0024
Spokane, WA 800.572.6565
Temple, TX 800.543.4415
Woodland, CA 800.759.6019