









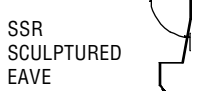

GENERAL INFORMATION **SLOPE DATA**

FLASHING ANGLE SPECIFIER CHART

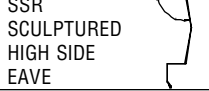
This chart should be used to determine the required specified angle when considering the following flashings.

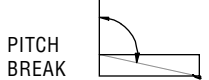
PROFILE/FLASHING	1/4:12	1/2:12	1:12	2:12	3:12	4:12	5:12	6:12	7:12	8:12	9:12	10:12	11:12	12:12	
 RIDGE	178°	175°	170°	161°	152°	143°	135°	127°	120°	113°	106°	100°	95°	90°	
 SSR RIDGE	178°	175°	170°	161°	152°	143°	Contact Metal Sales								
 VENTED RIDGE COVER	178°	175°	170°	161°	152°	143°	Contact Metal Sales								
 HIP	178°	177°	173°	167°	160°	154°	Contact Metal Sales								
 SSR SCULPTURED EAVE	91°	92°	95°	99°	104°	108°	113°	117°	120°	124°	127°	130°	133°	135°	
 EAVE	91°	92°	95°	99°	104°	108°	113°	117°	120°	124°	127°	130°	133°	135°	
 EXTENDED EAVE	91°	92°	95°	99°	104°	108°	113°	117°	120°	124°	127°	130°	133°	135°	
 SSR SCULPTURED HIGH SIDE EAVE	99°	98°	95°	91°	86°	82°	Contact Metal Sales								
 PEAK	89°	88°	85°	81°	76°	72°	67°	63°	60°	56°	53°	50°	47°	45°	
 VALLEY	178°	177°	173°	167°	160°	154°	148°	143°	138°	134°	130°	126°	123°	120°	
 PITCH BREAK	91°	92°	95°	99°	104°	108°	113°	117°	120°	124°	127°	130°	133°	135°	
 SSR HIGH SIDE PITCH BREAK	91°	92°	95°	99°	104°	108°	113°	117°	120°	124°	127°	130°	133°	135°	
 GUTTER DRIP	91°	92°	95°	99°	104°	108°	113°	117°	120°	124°	127°	130°	133°	135°	
 BOX GUTTER	91°	92°	95°	99°	104°	108°	113°	117°	120°	124°	127°	130°	133°	135°	
 SSR SCULPTURED GUTTER	A	101°	102°	105°	109°	114°	118°	123°	127°	130°	134°	137°	140°	143°	145°
	B	89°	88°	85°	81°	76°	72°	67°	63°	60°	56°	53°	50°	49°	45°
	C*	5 5/8"	5 3/4"	6"	6 1/2"	7"	7 1/2"	8"	8 1/2"	9"	9 1/2"	10"	10 1/2"	11"	11 1/2"
	C**	5 1/8"	5 1/4"	5 1/2"	6"	6 1/2"	7"	7 1/2"	8"	8 1/2"	9"	9 1/2"	9 7/8"	10 1/4"	10 5/8"
	C***	5"	5 1/8"	5 7/16"	5 15/16"	6 7/16"	6 15/16"	7 3/8"	7 13/16"	8 1/4"	8 11/16"	9 1/8"	9 1/2"	9 7/8"	10 1/4"

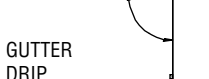
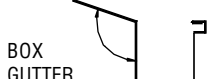
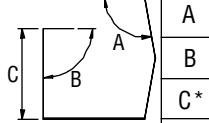
C* = Magna-Loc Sculptured Gutter C** = Seam-Loc Sculptured Gutter C*** = Snap-Loc Sculptured Gutter









GENERAL INFORMATION SLOPE DATA





metal sales
manufacturing corporation

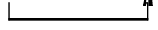
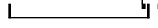

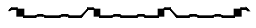
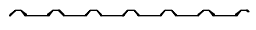
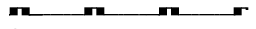

Corporate Office
(812) 246-1935
www.mtlsales.com

FULL LINE

-  **MAGNA-LOC**
-  **SEAM-LOC 24**
-  **SNAP-LOC 24**
-  **VERTICAL SEAM**
-  **PRO-LOC I**
-  **PRO-LOC II**
-  **PRO-LOC III**
-  **MINI-BATTEN**
-  **MAXI-BATTEN**
-  **IMAGE II**
-  **SOFFIT PANEL**

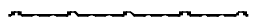
-  **STILE**
-  **IC72-PANEL**
-  **R-PANEL**
-  **U-PANEL**
-  **SPAN-LINE 36**
-  **SPAN-LINE 36A**
-  **V-LINE 32**

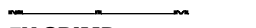
-  **PRO-PANEL II**
-  **CLASSIC RIB**
-  **5V CRIMP**

metal sales
manufacturing corporation



Corporate Office
 (812) 246-1935
 www.mtlsales.com

GENERAL INFORMATION **SLOPE DATA (CONT)**

ROOF SLOPE FACTOR CHART

This chart should be used when specifying and ordering Panels and Flashings. It will help you determine overall required length of material on sloped applications.

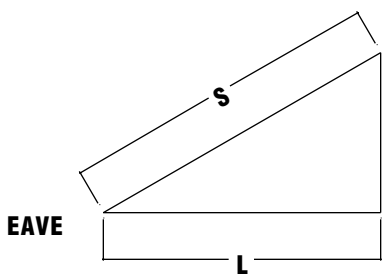

$(L) \times (\text{SLOPE FACTOR}) = S$

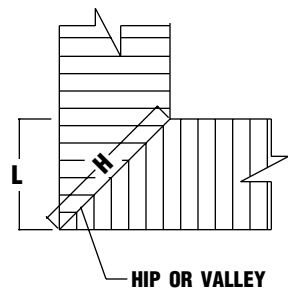

$(L) \times (\text{HIP VALLEY MULTIPLIER}) = H$

SLOPE	SLOPE FACTOR	HIP/VALLEY MULTIPLIER	SLOPE	SLOPE FACTOR	HIP/VALLEY MULTIPLIER
1:12	1.0035	1.4167	7:12	1.1577	1.5298
2:12	1.0138	1.4240	8:12	1.2019	1.5635
3:12	1.0308	1.4362	9:12	1.2500	1.6008
4:12	1.0541	1.4530	10:12	1.3017	1.6415
5:12	1.0833	1.4743	11:12	1.3566	1.6853
6:12	1.1180	1.5000	12:12	1.4142	1.7320

EXAMPLE:

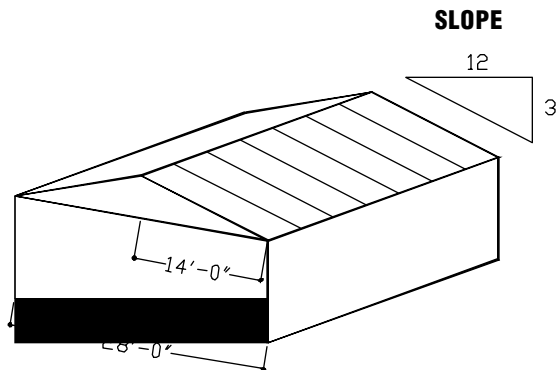
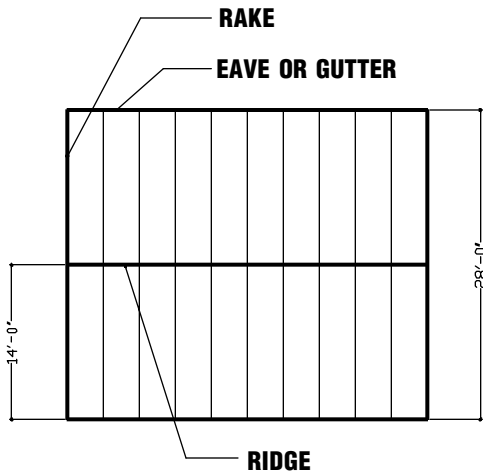

Your building is 28'-0" wide with a 3:12 pitch
 To determine the panel lengths for each side:

$(L) \times (\text{SLOPE FACTOR}) = S$

$14'-0" \times 1.0308(\text{from chart above for } 3:12 \text{ slope}) = 14.4312' \text{ OR } 14'-5"$