

SNAP-TY

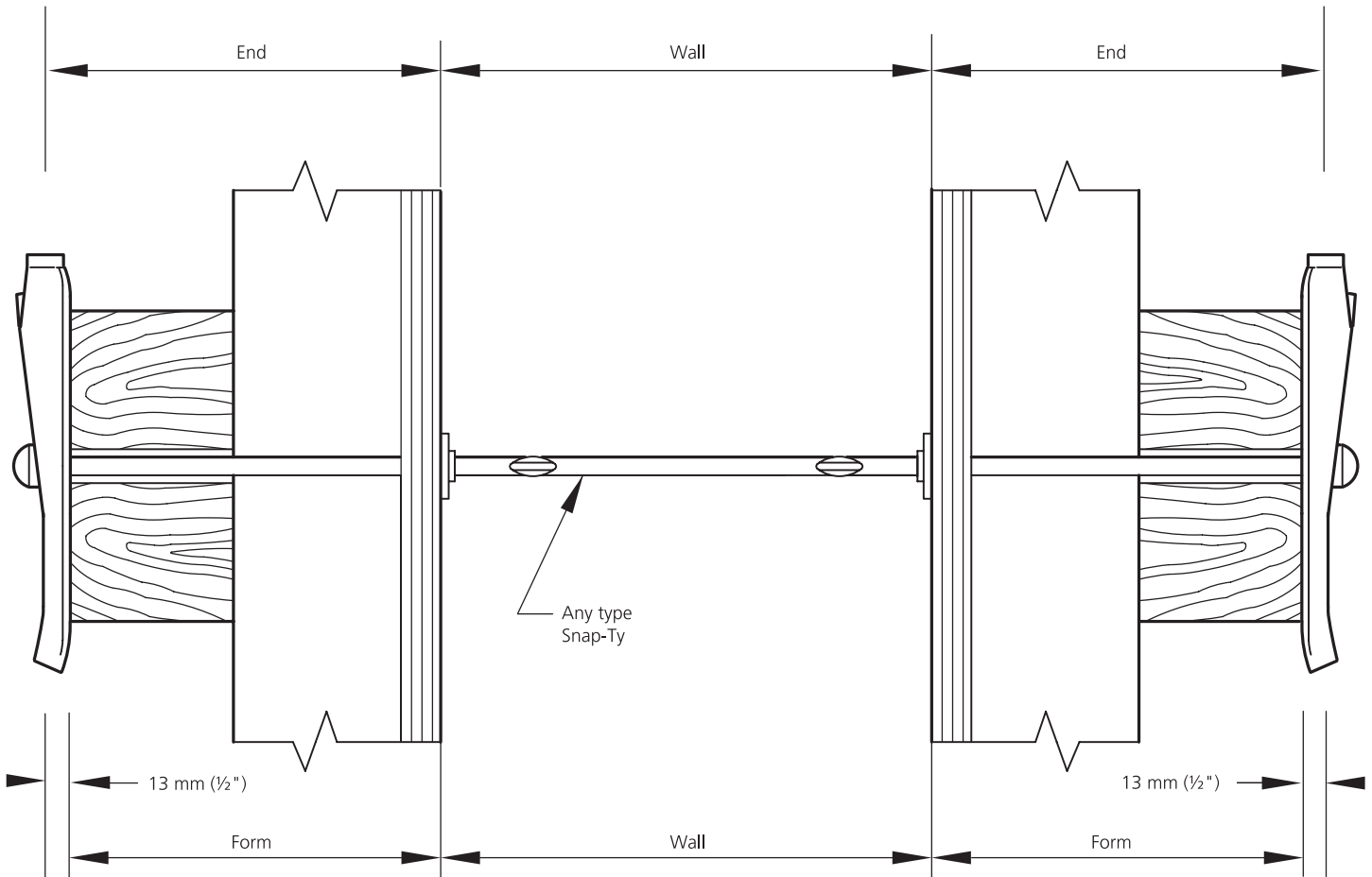

10 kN (2,250 lbs) Snap-Tys are available in stainless steel upon request.

AR Snap-Tys are fabricated to fit either prefabricated panels or built-in-place forms. They are specifically designed for quick, easy and accurate erection of light formwork. End sizes can be as short as 32 mm (1¼") for Steel Washer Snap-Tys or as long as you need them to fit a special condition. Snap-Tys can be fabricated for any required wall thickness up to 6 m (19'-6") in length. Spreader washers are precisely located to give exact wall thicknesses. Break points are located at specified distances back from the wall face to permit clean stripping without spalling. All standard Tys are manufactured to provide set back from the wall face. The small Ty holes and washer indentations are easily pointed, grouted or plugged. Consult the Technical Department for minimum wall thicknesses. For exposed concrete or where a longer set back is required, the AR Space-Ty™ is suggested.

Snap-Tys are stocked in 120 mm or 211 mm (4¾" or 8½") ends for standard wall thicknesses.

Distributed by:
National Concrete Accessories

1-888-777-9272 www.nca.ca

LIGHT CONCRETE FORMING

Plastic Cone Snap-Ty (PC)



The **AR Plastic Cone Snap-Ty** and the **AR Heavy Duty Plastic Cone Snap-Ty** are equipped with a Plastic Cone Spreader providing for a 25 mm (1") set back manufactured for specified wall thicknesses. The plastic cone reduces the likelihood of concrete paste seepage and protects the break back. The break back is approximately 3 mm (1/8") smaller than the cone length. The estimated break back is approximately 22 mm (7/8"). The table provides the length and taper of the cones. Special size cones are available as custom orders. Available in stainless steel.

Set back	Taper Inside to outside
25 mm (1")	10 mm to 25 mm (3/8" to 1")

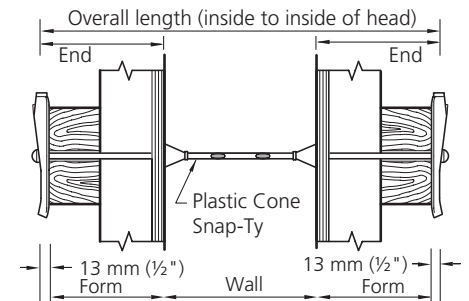

For architectural design, insert the Plastic Snap-Ty Plug once form work has been removed.

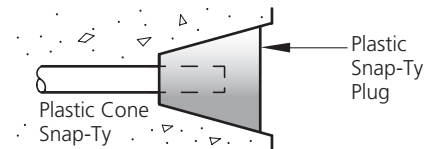

To order, please specify the following information

EXAMPLE
 Name Plastic Cone Snap-Ty (PC)
 Type Heavy Duty 3M
 End 120 mm (4 3/4")
 Wall 450 mm (18")
 End 120 mm (4 3/4")
 Break back (standard) 22 mm (7/8")
 Strength 13.5 kN (3,000 lbs)
 Quantity 300
 SWL is based on an approximate 2:1 Factor of Safety

**STANDARD 2.25M
 SAFE WORKING LOAD
 10kN (2,250 LBS)
 2:1 Safety Factor**

**HEAVY DUTY 3M
 SAFE WORKING LOAD
 13.5 kN (3,000 LBS)
 2:1 Safety Factor**

Plastic Washer Snap-Ty (PW)

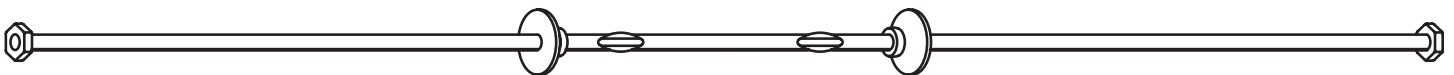

The **AR Plastic Washer Snap-Ty** and **Heavy Duty Plastic Washer Snap-Ty** are equipped with a plastic washer, provide for a 3 mm to 5 mm (1/8" to 3/16") break back less than the Plastic Washer Thickness and are manufactured for specified wall thicknesses.

The Hex Head allows the Ty end to be broken back prior to removal of the forms, allowing for ease of stripping. Available in stainless steel.

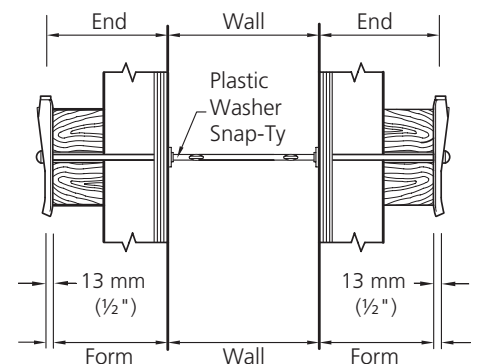

Plastic Washer break back is 3 mm to 5 mm (1/8" to 3/16") less than the plastic washer thickness.

To order, please specify the following information

EXAMPLE
 Name . . . Plastic Washer Snap-Ty (PW)
 Type Standard 2.25M
 End 210 mm (8 1/4")
 Wall 250 mm (10")
 End 210 mm (8 1/4")
 Break back (standard) as above
 Strength 10 kN (2,250 lbs)
 Quantity (pkg of 100) 400
 SWL is based on an approximate 2:1 Factor of Safety

**STANDARD 2.25M
 SAFE WORKING LOAD
 10kN (2,250 LBS)
 2:1 Safety Factor**

**HEAVY DUTY 3M
 SAFE WORKING LOAD
 13.5kN (3,000 LBS)
 2:1 Safety Factor**

Distributed by:
 National Concrete Accessories

1-888-777-9272 www.nca.ca

Steel Washer Snap-Ty (SW)

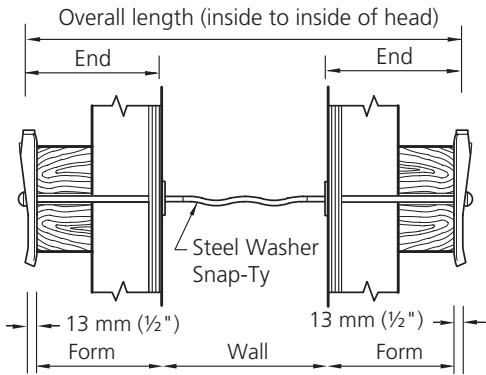

The **AR Steel Washer Snap-Ty** and the **AR Heavy Duty Steel Washer Snap-Ty** are manufactured for specified wall thicknesses. The Steel Washer Snap-Ty comes with a button head for 2.25M and Hex Head for 3M at each end. They are equipped with 24 mm (¹⁵/₁₆") flat spreader washers at each end and provides for a 15 mm (⁹/₁₆") break back. Manufactured in stainless steel upon request.

STANDARD 2.25M
SAFE WORKING LOAD
10kN (2,250 LBS)
2:1 Safety Factor

HEAVY DUTY 3M
SAFE WORKING LOAD
13.5kN (3,000 LBS)
2:1 Safety Factor

To order, please specify the following information

EXAMPLE

Name	Steel Washer Snap-Ty (SW)
Type	Heavy Duty 3M
End	120 mm (4 ³ / ₄ ")
Wall450 mm (18")
End	120 mm (4 ³ / ₄ ")
Break back	(standard) 15 mm (⁹ / ₁₆ ")
Strength10 kN (2,250 lbs)
Quantity	300

SWL is based on an approximate 2:1 Factor of Safety

NOTE: Break backs of over 25 mm (1") can be provided on special orders, but due to the increased concrete bond, AR cannot guarantee that the Tys will consistently provide the proper break backs.

No Washer Snap-Ty (NW)

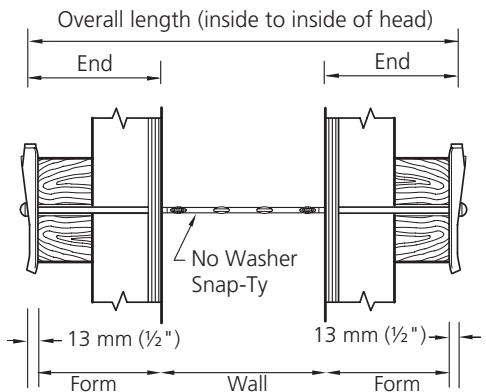
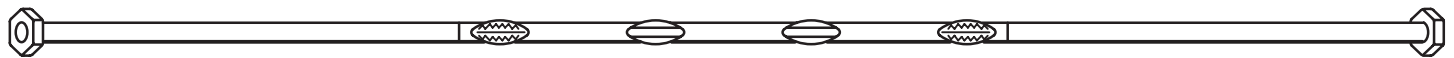

The **AR No Washer Snap-Ty** and **Heavy Duty No Washer Snap-Ty** have hex headed ends. These Snap-Tys are equipped with a 13 mm (¹/₂") break back and are manufactured for specified wall thicknesses. Available in stainless steel.

To order, please specify the following information

EXAMPLE

Name	No Washer Snap-Ty (NW)
Type	Standard 2.25M
End	210 mm (8 ¹ / ₄ ")
Wall200 mm (8")
End	210 mm (8 ¹ / ₄ ")
Break back13mm (¹ / ₂ ")
Strength10 kN (2,250 lbs)
Quantity (lots of 100)	200

SWL is based on an approximate 2:1 Factor of Safety

STANDARD 2.25M
SAFE WORKING LOAD
10kN (2,250 LBS)
2:1 Safety Factor

HEAVY DUTY 3M
SAFE WORKING LOAD
13.5kN (3,000 LBS)
2:1 Safety Factor

Spandrel Beam Snap-Ty

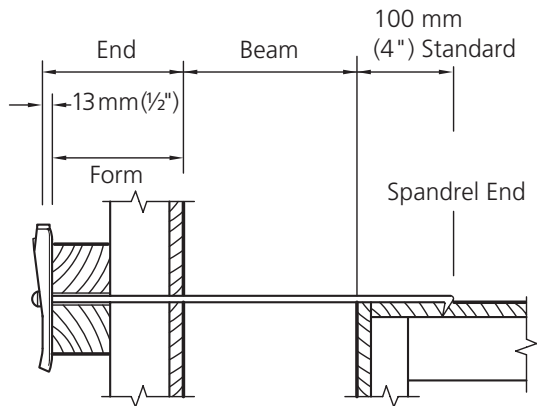

The **AR Spandrel Beam Snap-Ty** is available for light outside spandrel beam forms. The spandrel end has a right angle bent end 38 mm (1½") long with a chisel point designed to be driven into the deck forming. The standard end provides a break point 15mm (9/16") set back from the wall face.

To order, please specify the following information

EXAMPLE
 Name Spandrel Beam Snap-Ty
 End 150 mm (6")
 Beam Width 300 mm (12")
 Type of Form Plastic Cone
 Spreader 25 mm (1")
 Break back 15 mm (9/16")
 Quantity 200

SWL is based on an approximate 2:1 Factor of Safety
 SWL is controlled by strength of lumber at hook end

SAFE WORKING LOAD
1.1 kN (250 LBS)
2:1 Safety Factor

ALSO AVAILABLE WITH ANY
 TYPE OF SPREADER WASHER
 AND PLASTIC CONE.

Fascia Snap-Ty

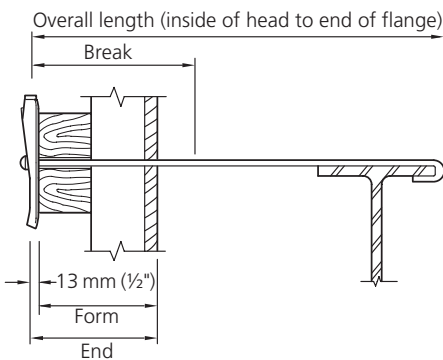
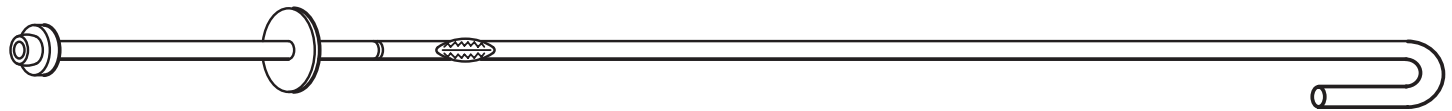

The **AR Fascia Snap-Ty** is available for securing light outside spandrel beam forms to structural steel beams in the manner shown.

To order, please specify the following information

EXAMPLE
 Name Fascia Snap-Ty
 End 200 mm (8")
 Overall Length 600 mm (24")
 Flange Depth 20 mm (3/4")
 Spreader Plastic Cone
 Break back 15 mm (9/16")
 Quantity 400

SWL is based on an approximate 2:0 Factor of Safety

SAFE WORKING LOAD
3.6 kN (800 LBS)
2:0 Safety Factor

ALSO AVAILABLE WITH ANY
 TYPE OF SPREADER WASHER
 AND PLASTIC CONE.

Stripping of Snap-Tys and guidelines for break back

AR Snap-Ty break backs are manufactured to exacting standards that ensure that they perform to load requirements while providing a consistent and reliable breaking point. However, many factors affect the performance of the break backs.

- Snap-Tys must not be bent during installation as the break back could be adversely affected.
- For best results, Tys are not to be removed until concrete has gained sufficient strength to prevent the Ty upset from rotating — typically 2 to 3 days. Attempting to break the Ty in green concrete may result in the Ty rotation in the concrete and make it difficult to break the Ty.
- Only Space-Tys have a guaranteed break back.
- Other Snap-Ty products are designed to provide a consistent break back, but can be affected by the concrete, which could generate difficulties in achieving a consistent break back.
- Products like the Steel Washer, No Washer and No Spreader Snap-Tys where the break back could be contained within the concrete require extra attention. With increased bond length NCA cannot guarantee that the Ty will consistently provide the proper break back. For these products, this is especially important where break backs of over $\frac{3}{4}$ " (20 mm) are desired. A good quality release agent/grease (acceptable non-staining) applied between the break back and the face of formwork (grease wire to be embedded, that will be removed — do not grease head area) may facilitate more consistent results. On site tests should be conducted to identify if consistent results can be achieved with the concrete mix and Ty.
- If the washer or cone is not free of the concrete, chip away the concrete using a hammer, screwdriver or drill to free the embedded components. Failure to free up the embedded components could result in the break back closer to the surface of the concrete instead of the desired break back location.

Use of the AR Snap-Ty and Space-Ty wrenches will assist with consistency, reduce risk of injury and speed up removal.

If in doubt, contact AR's technical department for assistance.

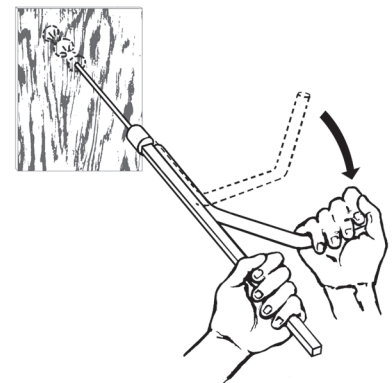
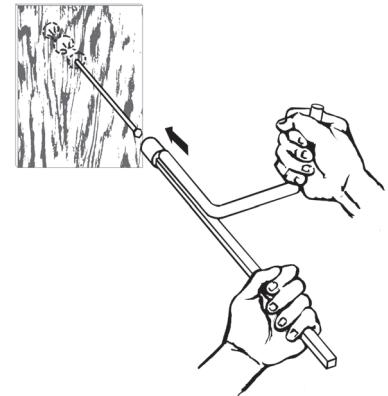

Space-Ty Wrench

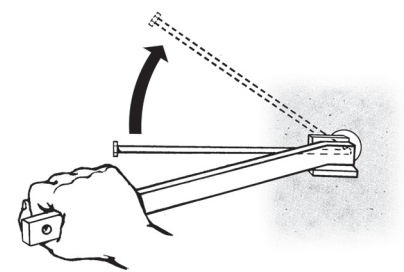
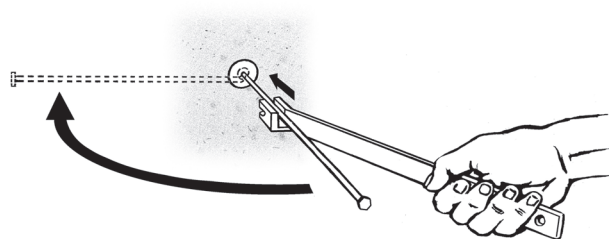

Snap-Ty Wrench

Light Formwork

Typical 3050mm (10'-0") High Wall Formwork, CONTROLLED RATE OF POUR

Form pressure kPa (PSF)

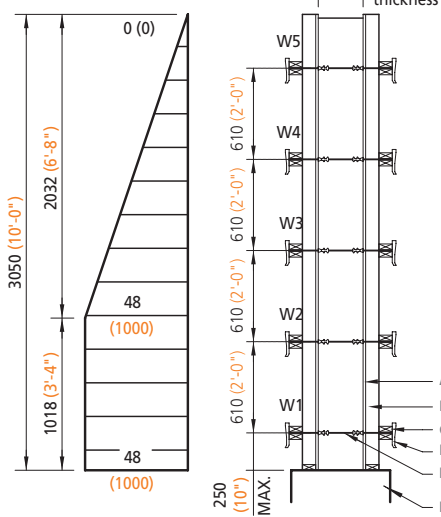

Snap-Ty
10 kN (2,250 lbs)

spacing:
W1, W2 and W3
@ 305 (12")
on centre

W4 and W5
@ 610 (2'-0")
on centre

Space-Ty™
13.4 kN (3,000 lbs) **spacing:**
W1, W2 and W3
@ 406 (1'-4")
on centre

W4 and W5
@ 610 (2'-0")
on centre

Typical 3050 mm (10'-0") High Wall Formwork, FULL LIQUID HEAD

Form pressure kPa (PSF)

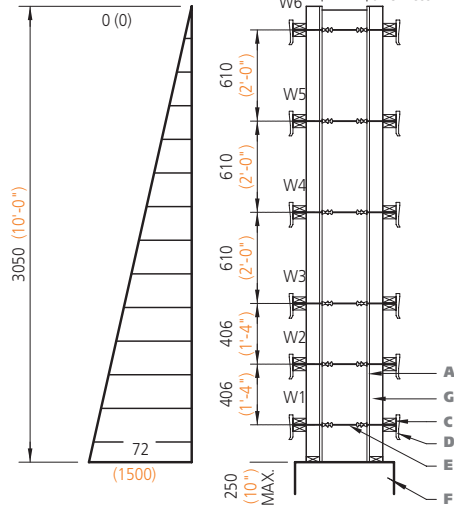

Snap-Ty
10 kN (2,250 lbs)

spacing:
W1, W2 and W3
@ 305 (12")
on centre

W4 @ 406
(1'-4") on centre

W5, W6
@ 610 (2'-0")
on centre

Space-Ty™
13.4 kN (3,000 lbs) **spacing:**
W1, W2 and W3
@ 406 (16")
on centre

W4, W5 and W6
@ 610 (2'-0")
on centre

Typical 6100 mm (20'-0") High Wall Formwork, CONTROLLED RATE OF POUR

Form pressure kPa (PSF)

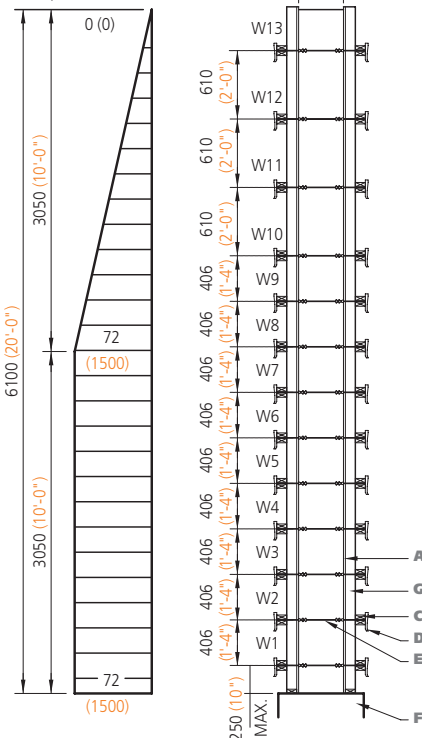

Snap-Ty
10 kN (2,250 lbs)

spacing:
W1 to W10 @ 305
(12") on centre

W11 @ 406
(1'-4") on centre

W12 and W13
@ 610 (2'-0")
on centre

Space-Ty™
13.4 kN (3,000 lbs) **spacing:**
W1 to W11
@ 457 (1'-6")
on centre

W12 and W13
@ 610 (2'-0")
on centre

Typical 6100 mm (20'-0") High Wall Formwork, FULL LIQUID HEAD

Form pressure kPa (PSF)

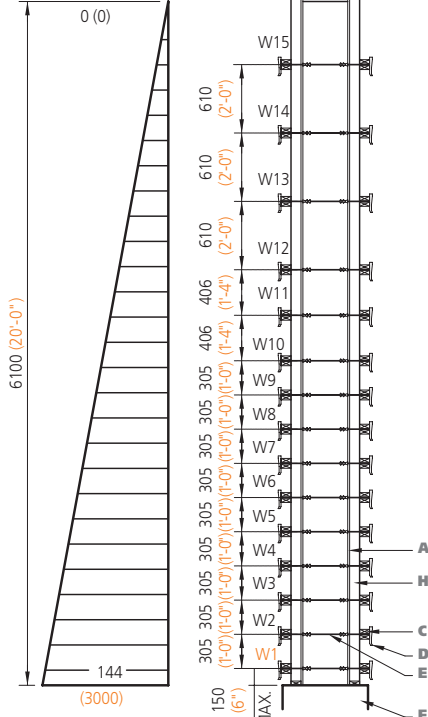

Space-Ty™
13.4 kN (3,000 lbs) **spacing:**

W1 to W12 @ 305
(12") on centre

W13 @ 406 (1'-4")
on centre

W14 and W15
@ 610 (2'-0")
on centre

CHART — MAXIMUM RISE OF CONCRETE IN FORMS IN METRES (FEET) PER HOUR

Liquid Head	5° C (40° F)	10° C (50° F)	15° C (60° F)	20° C (70° F)	25° C (80° F)
3050 mm (10'-0") High Wall, Controlled Rate of Pour	N/A	N/A	N/A	1 (3)	2 (5)
3050 mm (10'-0") High Wall, Full Liquid Head	N/A	N/A	N/A	N/A	N/A
6100 mm (20'-0") High Wall, Controlled Rate of Pour	N/A	N/A	N/A	2 (6)	3.5 (8)
6100 mm (20'-0") High Wall, Full Liquid Head	N/A	N/A	N/A	N/A	N/A