

SUSPENSION SYSTEMS

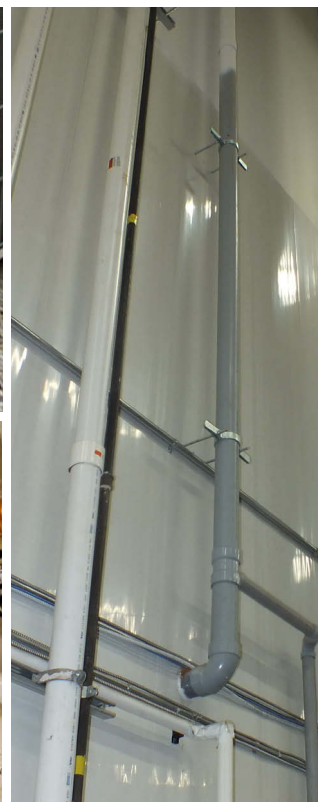

SUSPENSION CHANNELS

STRUT HARDWARE

STRUT FITTINGS

BEAM CLAMP HANGERS

PIPE HANGERS

PIPE MOUNTING

WIRE SUSPENSION

STRUT PIPE CLAMPS

SURFACE MOUNT

HANGERS

ROOFTOP SUPPORT

STRUT BEAM CLAMPS

HANGING & MOUNTING SUPPORTS

PIPE SUPPORT & PROTECTION



WHITE CAP[®]

SUSPENSION CHANNELS

5 QUESTIONS TO ASK when selecting the right strut for the job

1. What length of channel will be required for the job?

- › 10' (allows for easy handling)
- › 20'
- › Custom
 - job specific made to order
 - custom lengths
 - other strut channel combinations and configurations available

2. What is the required gauge depth for the job?





- › 12 Gauge
- › 14 Gauge
- › 16 Gauge

Different gauges and profiles available

3. What material is specified for the job?

- › Steel
- › Stainless Steel
- › Aluminum
- › Fiberglass

4. What strut perforation is required for the job?

- › Half Slotted 
- › Round Hole 
- › Long Slot/Full Slot 
- › Solid 
- › Concrete Insert Strut 

5. What type of finish is specified for the job?

- › Hot-Dipped Galvanized
- › Pre-Galvanized
- › Bare (Plain Steel)
- › Powder coated paint
- › PVC Coated

What is an application for Solid Strut?

For electrical raceway to be CSA approved, it must use solid strut and a steel closure strip



SINGLE STRUT CHANNEL PROFILES

Profiles shown are not to scale. Standard width of strut is 1-5/8". Measurement below indicates depth.

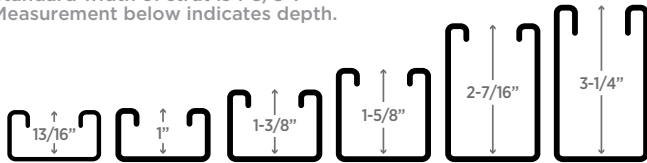

BACK-TO-BACK CHANNEL PROFILES

3-1/4" X 1-5/8" Back to Back Strut 3-1/4" X 1-5/8" Back to Side Strut 3-1/4" X 1-5/8" Side to Side Strut Other configurations available on request

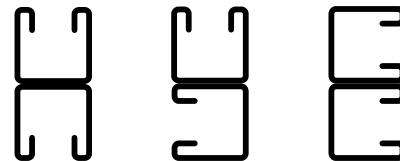

PERFORATION DIMENSIONS

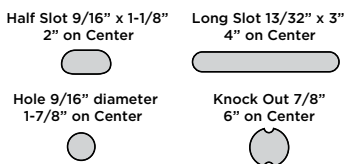

MATERIAL



FINISH

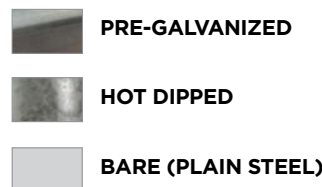

Need a custom strut channel solution?

We work with manufacturers and engineers to find the right solution for your project

Solutions include:

curved strut, custom lengths, depths, finishes, and specialty designs



Concrete Insert Strut

is embedded into concrete to facilitate a variety of hanging applications such as parking garages

Why Ethafoam?

Foam is pre-installed into strut before the concrete is poured so the concrete does not flow through the strut. Ethafoam is used because it comes out in one piece after the concrete has cured.

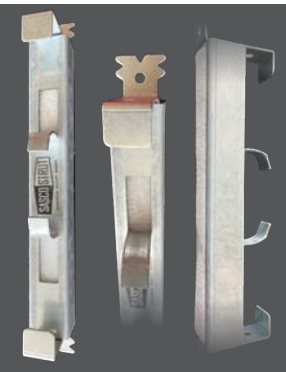

SUSPENSION CHANNELS

HOW TO PICK YOUR ACCESSORIES	CONNECT	SUPPORT	ATTACH
	ANGLE CONNECTOR	POST BASES	BEAM CLAMPS
	WING CONNECTOR	SHELF BRACKETS	CLIPS
	CORNER CONNECTOR	BRACKET SUPPORTS	CLAMPS
	SPLICE CHANNEL	ANGLE FITTINGS	STRAPS
	SPLICE PLATES	WING FITTINGS	SPRING NUTS
CONNECTOR PLATES	SPECIAL FITTINGS	TROLLEYS	

THREADED ROD

WE STOCK IMPERIAL AND METRIC THREADED ROD

- | | | | |
|--|---|---|--|
| FINISHES: <ul style="list-style-type: none"> ■ Bare Metal ■ Zinc Plated ■ Hot Dipped Galvanized ■ Exotic Finishes | THREADS: <ul style="list-style-type: none"> ■ Coarse ■ Fine ■ Coil (Lag) ■ Acme ■ Right & Left Hand | LENGTHS: <ul style="list-style-type: none"> ■ 3ft ■ 10ft ■ 12ft ■ 1m | MATERIALS: <ul style="list-style-type: none"> ■ Mild Steel ■ High Strength/B7 8.8/10.9 ■ Stainless Steel 304/316 ■ Brass ■ Aluminum ■ Nylon |
|--|---|---|--|
- CUSTOM AND CUT LENGTHS AVAILABLE**



PROJECT COMPONENTS THAT REQUIRE PRODUCTS TO MOUNT, SUPPORT OR SUSPEND THEM.

- Wire
- Pipe
- Conduit
- Cable
- Lighting
- Signs
- Ductwork
- Trapeze
- Cable Tray
- Gas Lines
- Hydraulic Lines
- Air Lines
- Strut Assemblies
- Beams
- Trolleys
- Shelves
- HVAC Units
- Solar Panels
- Walkways
- Posts

The use of suspension is integral to the installation of the electrical, mechanical, plumbing, fire protection, telecom or HVAC systems in any new building or building renovation.





EXPERIENCE · QUALITY · SERVICE

MANUFACTURER FOR STRUT CHANNEL, STRUT HARDWARE, STRUT FITTINGS & BEAM CLAMPS

Cut-to-length strut and other custom solutions also available

DON'T FORGET YOUR ADHESIVE ANCHORS



STRUT HARDWARE

WHEN ARE SPRINGS NEEDED?

The spring on a spring nut (clamp nut) holds it in place which allows the installer to have both hands free. It also provides the ability to attach threaded product to secure what the strut is supporting easier than without a spring. There are applications where you will require a clamp nut *without* a spring, such as an electrical raceway. You likely will not use a spring nut if the application includes wire or other product running through the strut. Otherwise, spring nuts may be something to consider in your suspension system plan.



The spring holds the nut in place while the threaded product is connected.



STRUT CLAMPING NUTS W/SPRING

- Regular spring
- For use with strut channels 1-5/8" deep
- Long and short spring also available
- Zinc plated

Also available in 316 Stainless Steel and hot dipped galvanized

HOLE DIAMETER 1/4" - 3/4"

INDUS1200075

STRUT SQUARE WASHER

- 1/4" thick material
- Hot dip galvanized finish

Also available in Electro-Galvanized

Hole diameter available 11/32" to 13/16"

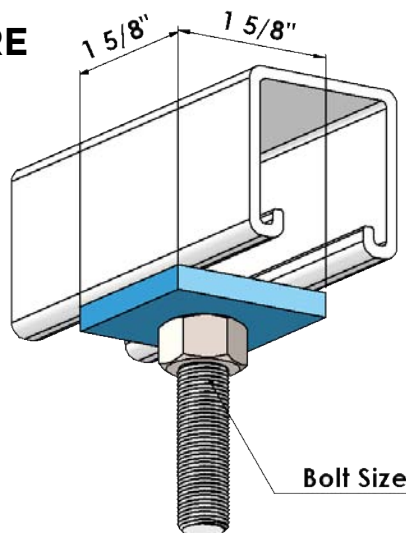

101W

STRUT CLAMPING NUT

- Without spring
- For use with strut channels 1-5/8", 1" or 13/16" deep
- Zinc plated

Also available in 316 Stainless Steel and Hot Dipped Galvanized

For use on all channel profiles

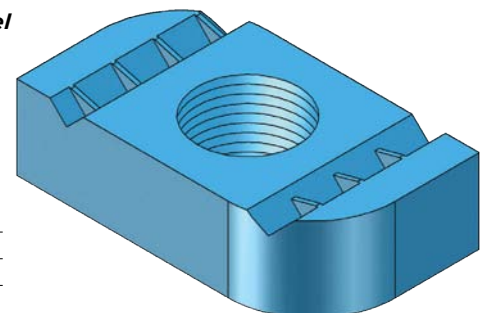

PRODUCT NO.	SIZE
INDUS12000711	1/4"
INDUS1200077	3/8"
INDUS12000802	1/2"

STRUT HARDWARE

STRUT END CAP

- Pre-galvanized material
- For end capping 1-5/8" X 1-5/8" strut channels

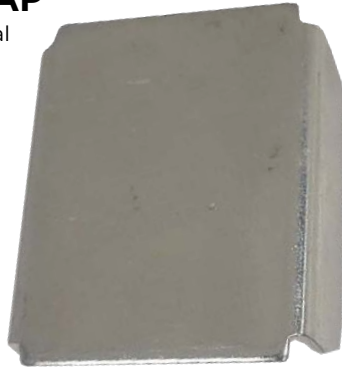

C2EC

STRUT CLOSURE STRIPS

- Pre-galvanized steel
- Snap into 1-5/8" wide strut channels
- 10' length



INDUS1200990

FOUR WHEEL U BODY TROLLEY

- Stainless steel bearings
- One 1" hole
- 100 lb. capacity
- Zinc plated finish



INDUS1203005

FOUR WHEEL PLATE TROLLEY

- Stainless steel bearings
- Three 9/16" holes
- 300 lb capacity
- Zinc plated finish



INDUS1203003

VERTICAL ROD STIFFENER

- Secures channel to hanger rod for vertical seismic bracing
- 1/2"-13 Zinc



INDUS12000805

DON'T FORGET YOUR
TAPCON CONCRETE SCREWS

LENGTH RANGE: 1-1/4" TO 6"



STRUT FITTINGS

SINGLE STRUT POST BASE

- For single 1-5/8" strut
- Hot dipped galvanized finish

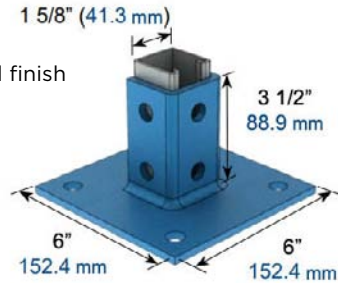

INDUS1200510

DOUBLE STRUT POST BASE

- For double 1-5/8" strut
- Hot dipped galvanized finish

DIFFERENT POST BASE CONFIGURATIONS AND FINISHES AVAILABLE

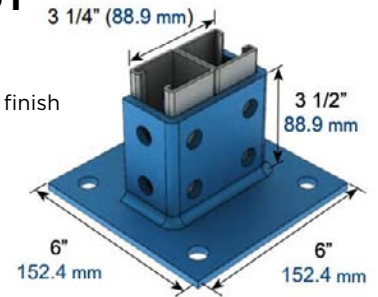

INDUS1200514

FOUR HOLE CORNER ANGLE

- 4 hole crossing connection bracket
- 1/4" thick material
- Hot dip galvanized finish

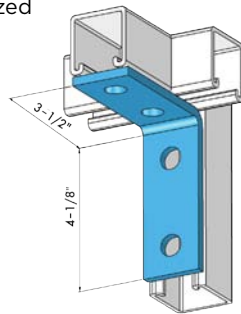

INDUS1200365

SEVEN HOLE CORNER ANGLE

- Universal Shelf Bracket
- 1/4" thick material
- Hot dip galvanized finish

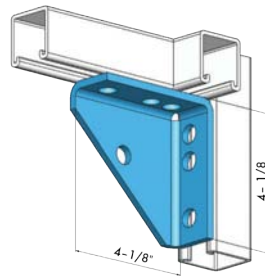

INDUS1200370

CANTILEVER SHELF BRACKETS

- Used for wall or strut channel mounting

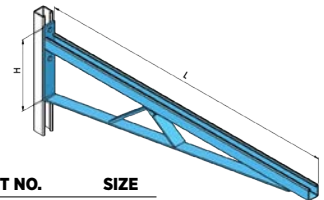

PRODUCT NO.	SIZE
INDUS1200650	19-1/2"
INDUS1200655	25-1/2"
INDUS1200660	31-1/2"
INDUS1200665	38-1/2"

FOUR HOLE SPLICE PLATE

- Hot dip galvanized finish
- 1/4" thick material
- 9/16" holes

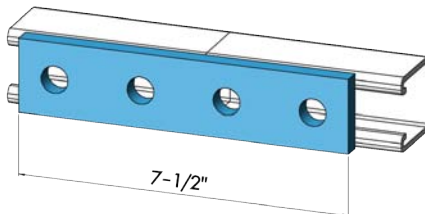

120S

FOUR HOLE T PLATE

- Corner Connections
- 1/4" thick material, 9/16" holes
- Hot dip galvanized finish

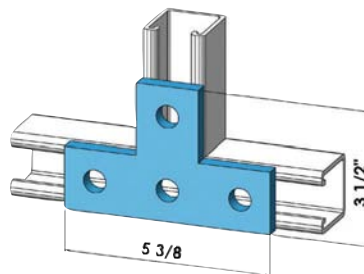

210T

FOUR HOLE FLAT PLATE

- Corner Connections
- 1/4" thick material, 9/16" holes
- Hot dip galvanized finish

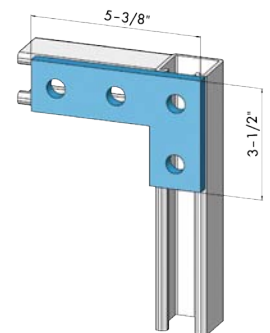

205P



EXPERIENCE · QUALITY · SERVICE

MANUFACTURER FOR STRUT CHANNEL, STRUT HARDWARE, STRUT FITTINGS & BEAM CLAMPS

Cut-to-length strut and other custom solutions also available

STRUT FITTINGS

EIGHT HOLE WING FITTING

- 8 9/16" holes
- 1/4" thick material
- 90° angle
- For 1-5/8" (W) channel

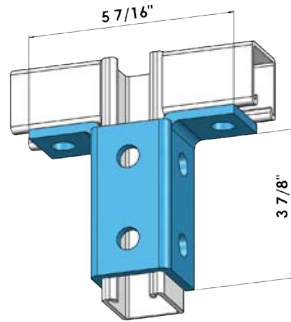

T608W

U SHAPE BRACKET

- 5 holes
- For use with 1-5/8" (D) strut channels
- 1-5/8" x 1-5/8" FTG
- 5-3/8" (L)
- Hot dip galvanized finish

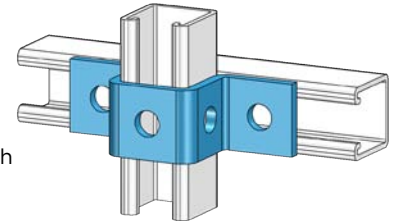

500U

FOUR HOLE U SHAPE SPLICE PLATE (W/NUTS)

- Supplied with four 1/4" x 5/8" FHMS and four 1/4" spring nuts - no spring
- Zinc plate finish, 6-3/4" long

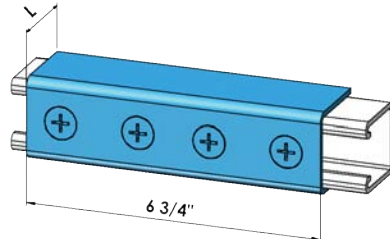

INDUS1200005

FOUR HOLE U SHAPE SPLICE PLATE

- Splicing 1-5/8" X 1-5/8" strut channels
- 1/4" thick material
- Hot dip galvanized finish
- 7-1/4" long

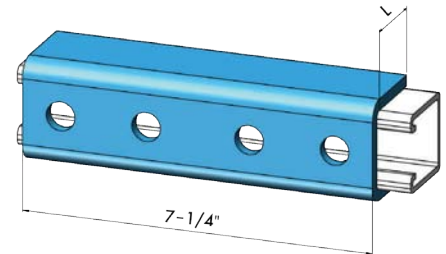

130SU

TWO HOLE 12" STRUT BRACE

- Size of brace is length of the diagonal - L
- 1/4" thick material
- Hot dip galvanized finish
- 45° angle

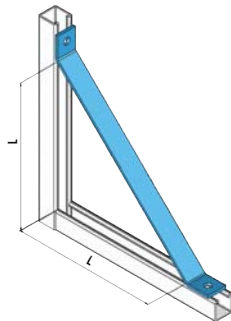

T908-12

Z SHAPED ANGLE

- 3 holes
- For use with 1-5/8" deep strut channel
- Hot dip galvanized finish

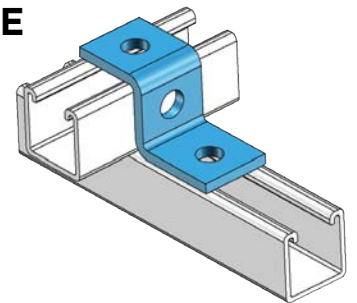

515Z

FOUR HOLE OPEN ANGLE

- Hot dip galvanized finish
- 1/4" thick material
- 9/16" holes

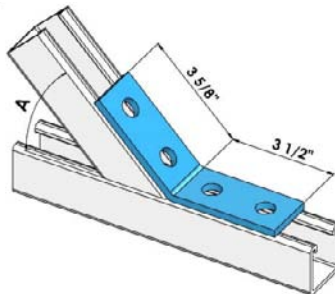

INDUS1200430

FOUR HOLE OPEN ANGLE

- Hot dip galvanized finish
- 1/4" thick material
- 9/16" holes

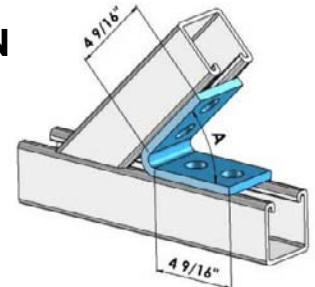

INDUS1200465

DON'T FORGET YOUR
**NUTS, BOLTS, WASHERS
AND SCREWS**



**ADDITIONAL STRUT FITTING
STYLES ARE AVAILABLE.**

CONTACT US FOR MORE INFORMATION.

BEAM CLAMPS HANGERS

HAMMER-ON FLANGE CLIP

- Provides a "portable" hole
- Fits most beams and bulb tees
- Installs with just a hammer
- Side mount

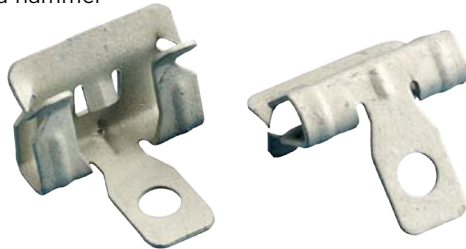

PRODUCT NO.	FITS FLANGE	STATIC LOAD LIMIT
CAD4H24	1/8" - 1/4"	200 LBS
CAD4H58	5/16" - 1/2"	200 LBS

HAMMER-ON FLANGE - ROTATING MOUNT

- Hammer-on beam clamp with attached nVent CADDY Cablecat J-Hook
- Supports low voltage cables
- Rotates 360 degrees to support various directional runs of cable



PRODUCT NO.	FITS FLANGE
CADCAT1224	1/8" - 1/4"
CADCAT1258	5/16" - 1/2"

HAMMER-ON FLANGE 5/16-1/2 CLIP

- Used to support pipe from beam flanges
- Requires only a hammer to install
- Spring steel material



CADM58S

HAMMER-ON 1/8-1/4 FLANGE

- Suspends threaded rod from beam flanges
- Threaded rod hanger can swivel to provide a vertical dropdown
- Requires only a hammer to install



CAD6T124

BEAM CLAMP 1/2-3/4 CONDUIT THRU 1/2" FLANGE FIG3

- Easy installation to beam flanges
- Eliminates offset bending conduit
- Conduit clip rotates 360°



CADBC812M

EM-M CONDUIT/PIPE TO FLANGE CLIP

- Supports conduit/pipe or cable from beam flanges
- Snap close clip pivots a full 360°
- Requires only a hammer to install



CAD812M58

STRAP HANGER CLIPS

- 90° offset hanger
- For supporting air ducts
- 1/8"-1/4" flange thickness
- 200 lbs. load rating
- Hammer on installation



CADMSR24

BEAM CLAMP HANGERS

3/8" TOP BEAM CLAMP

- Bare finish
- Designed for attaching hanger rod to the top flange of a beam or bar joist, where the thickness does not exceed 5/8"
- Malleable Iron
- Thread Pitch: 16



INDUS1200085

May not be exactly as shown

3/8" TOP BEAM CLAMP

- Zinc plated
- Designed for attaching hanger rod to the top flange of a beam or bar joist, where the thickness does not exceed 5/8"
- Malleable Iron
- Thread Pitch: 16



INDUS12000912

May not be exactly as shown

3/8" WIDE MOUTH TOP BEAM CLAMP

- Malleable Iron
- Designed for attaching hanger rod to the top flange of a beam or bar joist, where the thickness does not exceed 1-1/4"
- Thread Pitch: 16



INDUS12000902

May not be exactly as shown

CENTRE BEAM CLAMP AVAILABLE

CONTACT US FOR OPTIONS



TALK TO US ABOUT MECHANICAL & CHEMICAL ANCHOR SPECIFICATIONS.

WE ARE READY TO HELP.



PIPE HANGERS

SWIVEL LOOP HANGER

- For suspension of steel pipe
- Pre-galvanized finish with zinc plated insert nut
- ULC, UL and FM approved
- Complies with MSS SP-58 and SP-69 (Type 10)



SIZES BETWEEN 3/4" - 8"

Multiple domestic brands available

May not be exactly as shown

SWIVEL LOOP HANGER

- Designed for the suspension of steel pipe
- Pre-galvanized finish

Also available in *Stainless Steel and Hot Dipped Galvanized*



SIZES BETWEEN 3/4" - 8"

INDUS1200110

May not be exactly as shown

BLACK EPOXY COATED SWIVEL LOOP HANGER

- For suspension of copper tubing
- Black powder epoxy with zinc insert nut
- Complies with MSS SP-58 and SP-69 (Type 10)
- Available in other sizes



SIZES BETWEEN 3/4" - 8"

Multiple domestic brands available

May not be exactly as shown

BLACK EPOXY COATED SWIVEL LOOP HANGER

- For the suspension of copper tubing
- 3/8" rod



SIZES BETWEEN 3/4" - 8"

INDUS810555

May not be exactly as shown

COPPER COATED LOOP HANGER

- For suspension of copper tube



SIZES BETWEEN 3/4" - 8"

INDUS8105480

May not be exactly as shown

**CUSTOM HANGERS
AVAILABLE**

**CONTACT US TO
GET STARTED**

PIPE HANGERS

STANDARD DUTY CLEVIS HANGER

- For suspension of steel pipe
- Light duty clevis hangers also available
- Zinc plated

Also available in Hot Dipped Galvanized, Black Epoxy, Bare Metal, and Stainless Steel (316 & 304)



SIZE RANGE 1/2" - 24"
LARGER SIZES AVAILABLE UPON REQUEST

Multiple domestic brands available *May not be exactly as shown*

COPPER CLEVIS HANGER

- Recommended for the suspension of copper tubing, stationary pipe lines from 1/2" through 6" allowing for vertical adjustment



SIZE RANGE 1/2" - 6"

Multiple domestic brands available *May not be exactly as shown*

STANDARD DUTY CLEVIS HANGER

- For the suspension of steel pipe
- Light duty clevis hangers also available
- Zinc plated

Also available in Stainless Steel and Copper

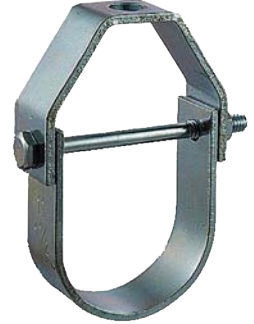

SIZE RANGE 3/4" - 14"

INDUS8104000 *May not be exactly as shown*

SPLIT RING HANGER

- Recommended for the suspension of non-insulated stationary copper tubing

Also available in Copper



SIZE RANGE 3/4" - 4"

Multiple domestic brands available *May not be exactly as shown*

SPLIT RING HANGER

- For the suspension of steel pipe
- Zinc plated
- Malleable Iron
- 3/8" rod
- Other sizes available

Also available in Stainless Steel



SIZE RANGE 1/2" - 2"

INDUS8105030 *May not be exactly as shown*

EPOXY COATED SPLIT RING HANGER

- For the suspension of copper tubing
- Copper colour epoxy
- Malleable Iron
- 3/8" rod
- Other sizes available

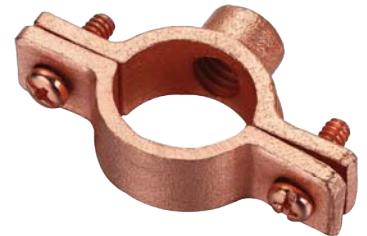

SIZE RANGE 1/2" - 2"

INDUS8105060 *May not be exactly as shown*



ADJUSTABLE ROLL HANGERS AND BELL/VAN PIPE HANGERS ALSO AVAILABLE

CONTACT US FOR MORE INFORMATION

PIPE MOUNTING

STANDARD RISER CLAMP

- For the support and stabilizing of vertical pipe runs
- Zinc plated
- Available in other sizes and short ear

Also available in Zinc plated, Hot Dipped Galvanized, Bare Metal



SIZE RANGE 1/2" - 36"
LARGER SIZES AVAILABLE UPON REQUEST

Multiple domestic brands available *May not be exactly as shown*

STANDARD RISER CLAMP

- For the support and stabilizing of vertical pipe runs
- Zinc plated
- Also available in short ear

Also available in Stainless Steel



SIZE RANGE 1/2" - 12"

INDUS1200283 *May not be exactly as shown*

COPPER RISER CLAMP

- Recommended for the support and stabilizing of vertical copper tubing pipe runs



SIZE RANGE 1/2" - 6"

Multiple domestic brands available *May not be exactly as shown*

EPOXY COATED RISER CLAMP

- For the support and stabilizing of vertical copper tube runs
- Copper colour



SIZE RANGE 3/4" - 4"

INDUS1200292 *May not be exactly as shown*

FLOOR FLANGE

- For attaching steel pipe to floors
- Malleable iron
- Zinc plated
- Other sizes available



FF112P

U-BOLT (PIPE SIZE) STANDARD

- Comes with 4 nuts; support, anchor, or guide for pipe
- Zinc plated

Also available in Stainless Steel and Hot Dipped Galvanized



SIZE RANGE 1/2" - 10"

INDUS0608045 *May not be exactly as shown*

DON'T FORGET YOUR
TAPCON CONCRETE SCREWS
LENGTH RANGE: 1-1/4" TO 6"



TW Buildex

CUSTOM PRODUCT AVAILABLE

CONTACT US TO GET STARTED

WIRE SUSPENSION SYSTEMS

EXPRESS 90° KIT

- XP 2 w/90° eyelet end 10ft (10 pack)
- Ideal for mechanical & electrical services
- Quick release button for rapid adjustments
- Supports up to 100 lb
- Smacna verified

Alternate end fixings available



G RIPPLE®

EXPRESS LOOP KIT

- XP 2 w/loop end 10ft (10 pack)
- Ideal for Mechanical & Electrical services
- Quick release button for rapid adjustments
- Supports up to 100 lb
- SMACNA verified

Alternate end fixings available



G RIPPLE®

DUCT TRAPEZE HVAC SOLUTION

- Butterfly trapeze duct support
- Apply at ground level solution
- Supports up to 100 lb
- SMACNA Verified
- Adjustment pin allows for rapid adjustment

Alternate end fixings available



G RIPPLE®

EXPRESS TOGGLE KIT

- XP 1 w/toggle end 10ft (10 pack)
- Ideal for signage & shop fittings
- Quick release button for rapid adjustments
- Supports up to 33 lb
- SMACNA Verified

Alternate end fixings available

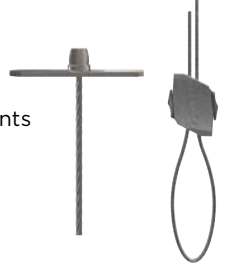

G RIPPLE®

UNIGRIP CENTRAL EXIT LOOP KIT

- UG 3 channel nut w/loop (10 pack)
- Up to 6x faster to install
- Quick release button for rapid adjustments
- Supports up to 240 lb
- Designed for services hung with channel

Alternate end fixings available



G RIPPLE®

DUCT TRAPEZE HVAC SOLUTION

- DT 2 rectangular duct support
- Supports rectangular ductwork
- SMACNA verified
- UL listed
- Adjustment pin allows for rapid adjustment

Alternate end fixings available



G RIPPLE®

GCS PIPE CLAMP

- Secures up to 9" O.D. piping systems
- Replaces 11 different clamp sizes
- Suitable for mechanical, plumbing & refrigeration pipes
- Quarter turn fixing solution for strut & Fast Trak

Small pipe clip accessory available



G RIPPLE®

STANDARD HANGER STUD KIT

- No.3 w/3/8" stud kit 15ft (10 pack)
- Ideal for all building services
- No tools or hot works permits required
- Supports up to 200 lb
- SMACNA Verified

Alternate end fixings available



G RIPPLE®

CONTACT US FOR SUPPORT ON SEISMIC APPLICATIONS

ROOFTOP SUPPORT



C-PORT ROOFTOP SUPPORT SYSTEMS

- Rubber rooftop pipe support
- Supports gas and refrigeration pipes, electrical conduit, ducting, roof walkways, HVAC, and solar racking
- Made from 100% recycled rubber
- UV-resistant
- Dampens vibrations
- May contribute to LEED credits

PRODUCT NO.	LOAD RATING	DESCRIPTION	SIZE
CLTC10	750 LBS.	BASE W/ CHANNEL	9.6" X 6" X 4-7/8"
CLTC20	1,500 LBS.	BASE W/ CHANNEL	19.2" X 6" X 4-7/8"
CLTCW12	1,200 LBS.	BASE W/ CHANNEL	12" X 12" X 3-5/16"
CLTCE1012	400 LBS.	BASE W/ ROD & CHANNEL	9.6" X 6" X 12"
CLTCXP	500 LBS.	RUBBER BASE ONLY	9.6" X 6" X 4"
CLTCXW	1,200 LBS.	RUBBER BASE ONLY	12" X 12" X 2-1/2"
CLTCE108	400 LBS.	ADJUSTABLE RISER	9.6" X 6" X 8"

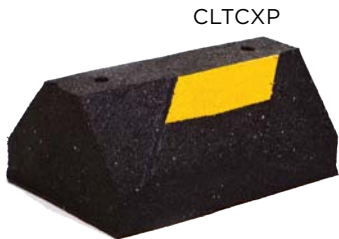

CLTCXP



CLTC10



CLTCXW

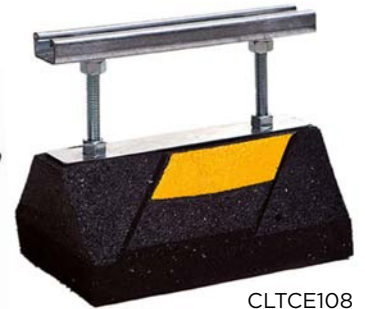

CLTCE108

ROOF TOP PIPE SUPPORT

- For gas, plumbing and electrical piping, mechanical platforms and roof walkways
- Heavy duty, lightweight plastic construction
- UV resistant
- Easy installation



INDUS8200150

CUSTOM CONFIGURATIONS AVAILABLE
CONTACT US TO GET STARTED

SURFACE MOUNT HANGERS

CEILING FLANGE

- Designed to hang threaded rod
- Malleable Iron
- Zinc plated



PRODUCT NO.	SIZE
INDUS12000950	3/8"
INDUS12000952	1/2"

ALUMINUM CEILING FLANGE

- Designed to hang threaded rod
- Made from structural strength aluminum
- 1/4" thick material
- 1/4-20 thread



INDUS12000941

CADDY #38 3/8 OFFSET EYE

- Structural attachment used to join hanger rod to a structure
- Provides full vertical rod adjustment



CAD0380037EG



HANGER BRACKETS

- Angle bracket with 1/4" holes
- Permits wire or chain drops from concrete or wood
- Other sizes/configurations available



CADAB

HANGER W/ IMPRESSIONS

- Supports wire or rod from block or concrete walls
- For 3/8" threaded rod



CAD6TI

Q-DECK HANGER

- For suspending threaded rod from Q-deck
- Made from structural aluminum

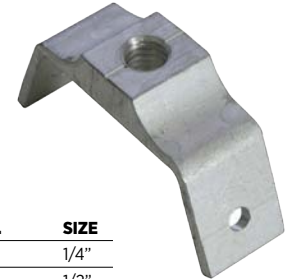

PRODUCT NO.	SIZE
QD-14	1/4"
QD-12	1/2"

ROD LOCK SPRING STEEL STRUT NUT

- Design allows to simply push the threaded rod through mounting hole
- Works with slightly damaged threads and minor burrs on the threaded rod



CAD4QCNTS

ANGLE HANGER

- Suspends threaded rod from horizontal structures such as laminated wood or concrete beams, joists, ceilings and walls



PRODUCT NO.	DESCRIPTION
CAD4TIB	FOR 1/4" THREADED ROD W/IMPRESSIONS
CAD6TIB	FOR 3/8" THREADED ROD

BOLT CLOSE CONDUIT/ PIPE CLAMP

- Retained bolt and built-in nut means there are less parts to handle or drop



PRODUCT NO.	SIZE
CADCD1B37	CLIP FOR 3/4" RIGID/EMT
CADCD0B37	CLIP FOR 1/2" RIGID/EMT
CADCD5B37	CLAMPS W/BOLTS 2" RIGID/EMT
CADCD2B37	CLAMPS W/BOLTS 1" RIGID/EMT

ANGLE BRACKET - 1/4" MOUNTING HOLE

- Angle bracket support with attached nVent CADDY Cablecat J-Hook
- Supports low voltage cables



CADCAT12AB



STRUT PIPE CLAMPS

ONE PIECE STRUT CLAMP FOR CONDUIT

- One piece break apart strut clamp for EMT and Rigid conduit
- Includes thread impression and captured screw
- Steel material
- Other sizes available

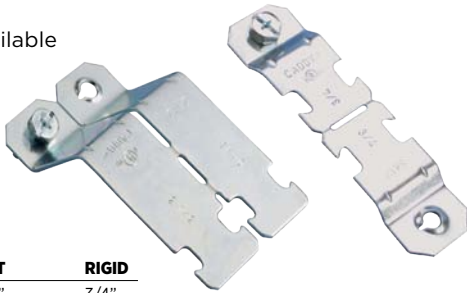

PRODUCT NO.	EMT	RIGID
CADSK125I	3/4"	3/4"
CADSK165I	1"	1"

ONE PIECE STRUT CLAMP FOR CABLE/CONDUIT

- Zinc plated
- Requires only a screwdriver or nutdriver for installation
- Other sizes available



PRODUCT NO.	EMT	RIGID
CADSCH12B	3/4"	1/2"
CADSCH20B	1-1/4"	1"

RIGID PIPE CLAMP

- Mount rigid pipe conduit to strut
- 2 piece clamp
- Zinc plated
- Also available in aluminum



SIZE RANGE 1/2" - 8"

PRODUCT NO.	SIZE
INDUS1200055	2"
INDUS1200065	3"
INDUS1200067	4"

May not be exactly as shown

STRUT PIPE CUSHION CLAMPS

- For attaching pipe to strut
- Zinc plated
- Size based on pipe outside diameter



SIZE RANGE 3/8" - 3-1/8"

PRODUCT NO.	PIPE CAPACITY
INDUS8105106	3/4"
INDUS8105114	1-1/2"
INDUS8105124	2-3/8"

May not be exactly as shown

NEED A CUSTOM SOLUTION?

CONTACT US TO GET STARTED

DON'T FORGET YOUR NUTS, BOLTS, WASHERS AND SCREWS



STRUT BEAM CLAMPS

U-BOLT BEAM CLAMP

- For strut channels up to 1-5/8" (D)
- Use in pairs
- Up to 1000 lb. loads (each)
- Hot dip galvanized clamp
- Other sizes available

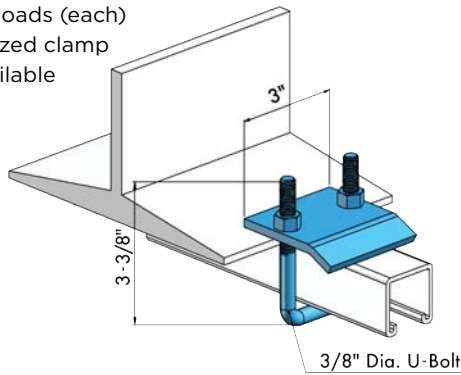

815BC

WINDOW BEAM CLAMP

- Hot dip galvanized finish
- Use in pairs
- Other sizes available

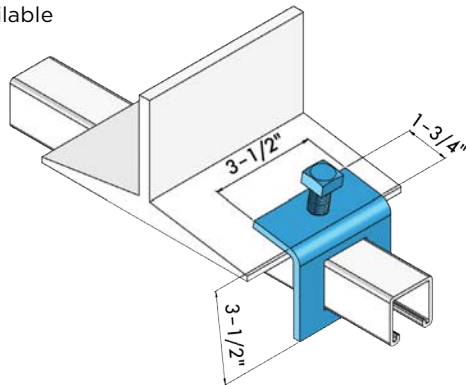

800BC

COLUMN BEAM CLAMP

- Used between column flanges
- Use in pairs

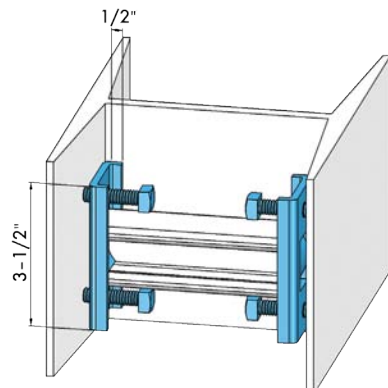

825BC

DON'T FORGET
YOUR **FIRESTOP**

FIRE BARRIER
WATER TIGHT
SEALANT



FD 150+
FIREDAM™
FIRE BARRIER
SEALANT



FIREDAM™
SPRAY 200

3M



HANGING MOUNTING SUPPORTS

TELESCOPING SCREW GUN BOX BRACKET

- Adjustable for non-standard stud spacing
- Capable of mounting multiple deep boxes

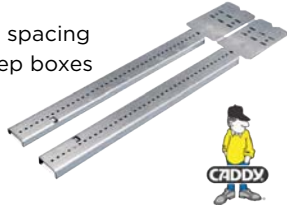

PRODUCT NO.	DESCRIPTION
CADTSGB16	11"-18" STUD SPACING
CADTSGB24	17"-26" STUD SPACING

SNAP TO STUD CABLE SUPPORT

- Snap to stud function makes installation fast and easy, saving time and increasing productivity
- No tools or fasteners needed for installation

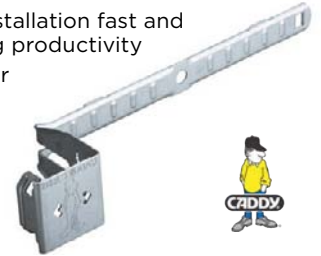

CADCJ6STS

COMBO BOX/CONDUIT HANGER, 1/2", 3/4" EMT, W/SCREW

- One assembly provides support for horizontal electrical box and/or conduit from threaded rod



CAD812MB18S

CONDUIT HANGERS MC/AC OR BX TO #8 WIRE

- Supports conduit to rod, wire or flange
- Can also be used for flexible metallic tubing, armored cable, portable cables, control tubes and communications cable



CADKX

HEAVY DUTY BOX HANGER W/ MOUNTING CLIP

- 24" span
- Quickly mounts a box to T-grid
- Adjustable height for various electrical box depths



CAD512HDTTC

INDEPENDENT SUPPORT CLIP

- Provides a means of independent support for fixtures
- 5/16" grid size, 5/8" stud length



CADIDS

CONDUIT CLAMP WITH BOLT

- Installs w/ screwdriver or nut driver for fast, easy installation
- Accommodates 1/2" to 4" EMT or rigid conduit



PRODUCT NO.	EMT	RIGID
CADCD1B	3/4"	3/4"
CADCD2B	1"	1"
CADCD25B	--"	1-1/4"
CADCD5B	2"	2"

CADDY PRESS-ON NAIL PLATE

- Protects electrical and mechanical installation through studs
- For wood and metal studs



CAD304B2

24" BOX MOUNTING BRACKET (4" OR 4-11/16")

- Eliminates need for electrical box on low voltage applications
- Supports electrical boxes, plaster rings or low voltage devices from one bracket



CADRBS24

MOUNTING BRACKET SING GANG (NON-METALLIC)

- No sharp metal edges with plastic design
- Fast, easy to install



CADMP1P

PIPE SUPPORT & PROTECTION



ROLLER CHAIRS & INSULATION SHEILDS ALSO AVAILABLE

CABLECAT CAT J-HOOK

- Cost effective alternative to expensive cable tray
- Galvanized finish on J-Hooks provide smoother cable pull and greater corrosion resistance



PRODUCT NO.	DIAMETER
CADCAT12	3/4" (19MM)
CADCAT32HP	2" (50MM)

CABLECAT CAT J-HOOK TO MULTI-FUNCTION BRACKET

- Cost effective alternative to expensive cable tray
- Galvanized finish on J-Hooks provide smoother cable pull and greater corrosion resistance



CADCAT16HP4Z34

PIPE SLEEVE POSITIONER

- Prevents movement during concrete pours
- Used for Schedule 40 pipe with sleeve diameters of 2" - 6"
- Other sizes available



CAD740

STANDARD PIPE STAY

- Vertical or horizontal offset pipe guide
- Black epoxy coated
- For copper tube or iron pipe
- 3/4" C - 1/2" IP
- Other sizes available



INDUS0608105

RIGID PIPE STRAP

- Two hole style
- Galvanized
- Other sizes available



PRODUCT NO.	PIPE SIZE
INDUS2000170	1"
INDUS2000171	1-1/2"

DON'T FORGET YOUR SILICONE, SEALANTS AND FOAMS

NuFlex®
SEALANTS

NUFLEX 302 GENERAL PURPOSE SILICONE



NUFLEX 302 HIGH TEMP. SILICONE



PURFECTSEAL FOAM



ULTRA SEAL PF-50 STRAW FOAM



YOUR SOURCE FOR CONSTRUCTION, INDUSTRIAL & SAFETY SUPPLIES

INVENTORY



- › Fasteners, power tools, safety supplies, hand tools, masonry, building envelope solutions, concrete accessories, geotechnical products and more

ORDERING



- › Dedicated account manager as your one point of contact
- › One-stop shop for a variety of construction solutions

TRAINING



- › Demonstrations from industry experts
- › On-site vendor-led product training

DELIVERY



- › Variety of delivery methods that align with your schedule
- › Reliable and flexible delivery options to suit your needs

CREDIT ACCOUNT ADVANTAGES



- › Flexible credit limits
- › Multiple billing options
- › Orders can be placed ahead of payments

UNIQUE AND SPECIAL ORDERS



- › In-stock on hard to find items
- › Unique and special orders
- › Custom orders

VENDOR MANAGED INVENTORY

- › Frequent replenishment of your selected inventory to save you time and money
- › Quick turnaround time on non-inventory items
- › Customized dynamic reports on inventory usage



SAFETY SUPPLIES



CONCRETE TOOLS & ACCESSORIES



FASTENERS & ANCHORS



MASONRY

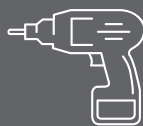

POWER & HAND TOOLS



CUTTING & ABRASIVES



GEOTEXTILES



BUILDING ENVELOPE



WHITE CAP®

WHITECAPSUPPLY.COM



@WHITECAPSUPPLY