

RAINBARRIER® MINERAL WOOL CONTINUOUS INSULATION SYSTEM GUIDE

Standards and Code Compliance, Installation, Attachment



Goodyear World Headquarters
Akron, OH



University of Michigan, North Quad
Ann Arbor, MI



Museum of the Moving Image
Queens, NY



University of Washington Bothell, Discovery Hall
Bothell, WA

THERMAFIBER® RAINBARRIER® MINERAL WOOL CONTINUOUS INSULATION SYSTEM GUIDE

Engineered with Owens Corning technical expertise and backed by building science, Owens Corning® Thermafiber® RainBarrier® mineral wool continuous insulation delivers buildings that perform without compromising design.

- Introduction** 4

- Overview** 5–8
 - Continuous Insulation (CI) Definition and Benefits
 - Evolution of Continuous Insulation
 - Drivers of Continuous Insulation

- Product Selector** 9–13
 - Thermafiber® RainBarrier® Mineral Wool Continuous Insulation Portfolio
 - Technical Data, Performance Attributes, and Attachment Methods
 - Cladding Attachment
 - Cladding Weight for High Compressive Products

- Attachment and Support** 14–27
 - Common Support Methods
 - Fasteners
 - Common Fastener Types
 - Fastener Placement
 - Panel Layout
 - Installation of Mineral Wool Insulation
 - Clip and Rail Systems
 - Mineral Wool Insulation with Concrete, CMU, and Brick
 - Cladding Assemblies by Weight
 - Deflection Testing
 - Stacking Guidance
 - Span Tables for High Compressive Products

- Other Considerations** 28–30
 - Exposure
 - Fire and Smoke Protection

- Further Information** 31
 - Product Literature and Samples
 - Referenced Standards

INTRODUCTION

Owens Corning® Thermafiber® RainBarrier® Mineral Wool Continuous Insulation (CI)

As society demands more energy-efficient buildings, codes and builders are responding by increasing the R-value of the building enclosure. Given that the cavities of the standard framed walls typically used are already filled with insulation, the clear path forward to higher R-values is to add exterior insulation. There are many advantages to exterior insulation, including reducing the thermal bridging of the framing, significantly reducing cold-weather condensation risk within the cavity, maintaining the frame and structure closer to indoor temperatures with reduced variations in humidity, and decreasing the energy required for space conditioning. To realize the greatest thermal benefits of exterior continuous insulation, it must be installed in a way to minimize heat losses through the insulation layer.

This system guide examines the numerous attachment methods, codes, and standards governing these methods and the Owens Corning® Thermafiber® RainBarrier® mineral wool continuous insulation (CI) products specifically designed and engineered to meet the demands of these varied applications.

Thermafiber® RainBarrier® is designed to work with a diverse range of exterior wall or open-joint façade systems. Whatever the specifications of your next project, RainBarrier® delivers benefits for numerous performance requirements.

The Benefits of Thermafiber® RainBarrier®



Water Resistance

RainBarrier® is engineered to repel and drain water.



Thermal Comfort

RainBarrier® R-values contribute to energy efficiency and will not decrease as the insulation ages.



Fire and Smoke Protection

RainBarrier® can withstand temperatures over 2,000°F.



Installation

RainBarrier® is a forgiving insulation that speeds installation and uses no blowing agents, requiring minimal PPE during installation.

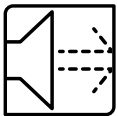

Sound Control

RainBarrier® helps control noise between floors, through walls, and from outdoors.



Sustainability

RainBarrier® is produced with a minimum 70% recycled content¹ and contributes to credits in several green building programs, such as LEED^{®2} and Green Globes[®]. RainBarrier® products also have a certified Declare Label.



Water Vapor Permeance

RainBarrier® provides a high level of vapor permeance and helps manage vapor flow, which keeps moisture from collecting on cooler surfaces.

¹ Verified by ICC-ES to contain a minimum of 70% recycled content. See ICC-ES Evaluation Report VAR-1025 at icc-es.org.

² LEED[®] is a registered trademark of the U.S. Green Building Council.

OVERVIEW

Continuous Insulation (CI) Definition and Benefits

What Is Continuous Insulation (CI)?

ASHRAE 90.1³ defines continuous insulation as insulation that is uncompressed and continuous across all structural members without thermal bridges other than fasteners and service openings. It is installed on the interior or exterior and to any opaque surface of the building envelope.

ASHRAE Standard 90.1 is one of two primary baseline building energy codes that may be adopted by states and local jurisdictions to regulate the design and construction of new buildings. ASHRAE 90.1 is limited to commercial buildings, while the International Energy Conservation Code® (IECC)⁴ addresses both residential and commercial buildings.

As cities across the United States bolster their clean energy efforts, stricter building energy codes are some of the biggest success stories. Energy efficiency codes are becoming more stringent, and these efforts are helping to reduce heat loss through the building, and increase efficiencies and occupant comfort.

Benefits of Continuous Insulation

- **Reduces thermal bridging and increases overall R-value.** Thermal bridging is a type of heat loss that occurs when heat flows through the building envelope via a continuous path, such as through wood or, more commonly, highly conductive steel framing members. Thermal bridging dramatically affects whole-wall R-value. For instance, a steel stud wall assembly with batt insulation could lose up to 75% of its R-value through thermal bridging.⁵ Continuous insulation helps to mitigate thermal bridges while providing several additional benefits including energy conservation and enhanced durability.
- **Creates barrier continuity.** Air and water barriers can be installed as a single material adjacent to wall sheathing, keeping barriers continuous, a necessary performance attribute of high performing structures.
- **Reduces moisture concerns.** CI reduces the possibility of condensation within the wall when warm, moist air is prevented from reaching a dew point temperature.
- **Flexibility.** CI allows for vapor barrier placement to be on the interior or exterior, or in the same plane as the air and water barrier. Reduces the risk of dual vapor barriers.

³ ANSI/ASHRAE/IES Standard 90.1, Energy Standard for Buildings Except Low-Rise Residential Buildings. American Society of Heating, Refrigerating, and Air-Conditioning Engineers. <https://www.ashrae.org>.

⁴ International Energy Conservation Code, International Code Council, <https://iccsafe.org>.

⁵ <https://sustainabilityworkshop.autodesk.com/buildings/total-r-values-and-thermal-bridging>.

OVERVIEW

Evolution of Continuous Insulation

The Evolution of Energy Efficiency

In the simplest terms, the exterior wall or shell provides protection from the weather or outside environmental conditions. It provides interior occupants protection from heat, cold, water, and the overall outside environment. It also provides protection from solar radiation, outside noise, fire, security, and aesthetics.

In the late 19th century and early 1900s, an exterior wall would look much like the assembly pictured: structural masonry wall (in this illustration, triple wythe), great for structure and moisture but with no insulation, not very good for thermal performance. In this period, the fuel and materials used to heat these structures were very inexpensive, so it didn't matter that they were drafty, damp, and needed a lot of energy to regulate.

Evolving up through today's assemblies with the emphasis on energy reduction, and numerous other performance attributes, we see systems that effectively manage air, water, and thermal performance elements all in one assembly.

We now have improved designs, building on previous assembly iterations, with continuous insulation, effective air barrier, water management, and thermal bridging reduction, including, in some cases, the use of thermally isolated specialty fasteners and support members.

We have come a long way with the development of energy-efficient buildings.

1900s

No Insulation

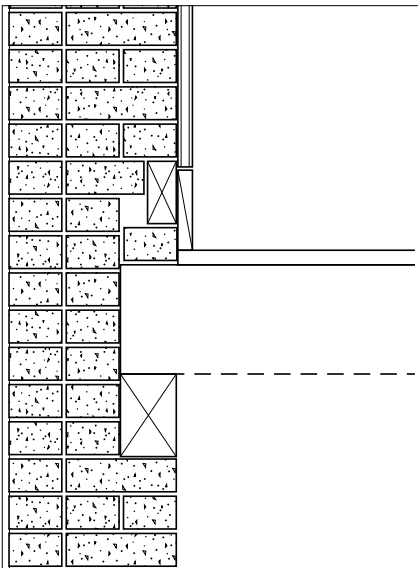

In the 1900s, an exterior wall would have no insulation.

1940s–1970s

Limited Insulation

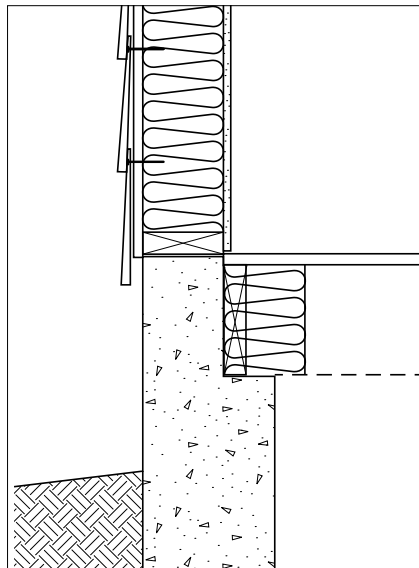

As we move into the 1940s and especially during the energy crisis of the 70s, designers and building owners start to recognize the need for more insulation, but it's still used in a limited amount.

Current

Integrated Air/Water/ Thermal Assembly

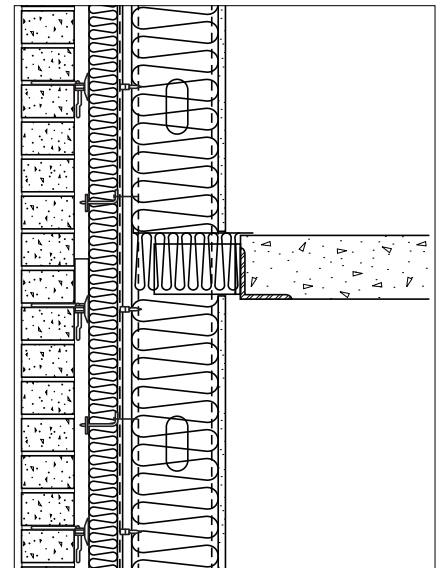

In today's designed assemblies with the emphasis on energy reduction and sustainable construction, we now see systems that incorporate air, water, and thermal efficiency all in one assembly. These systems must work correctly and in concert with each other in order for the entire wall assembly to perform as desired.

OVERVIEW

Drivers of Continuous Insulation

Striving for Continuous Efficiency

Choosing the right insulation and placing it in the right location is becoming one of the most important decisions in design, construction, and retrofit, as insulation has a dramatic impact on the energy efficiency of a building. To design energy-efficient buildings that will meet stringent energy codes and performance expectations, the use of continuous insulation on the exterior of the building is critical.

Continuous insulation nearly eliminates thermal bridging. This is the type of heat loss that occurs when heat flows through the building envelope via a continuous path, such as through wood studs, or more commonly, highly conductive steel framing members. Thermal bridging dramatically affects entire wall R-value. For instance, a steel stud wall assembly with batt insulation will lose 50% of its R-value through thermal bridging.

In addition to the management of thermal bridging, having the insulation outboard of the structure has other advantages. Air and vapor barriers can be installed as a single material adjacent to wall sheathing, allowing for continuity of the barriers. Placing the insulation outboard of the support structure will also move the dew point closer to the outer face of the wall, reducing the potential for condensation within the wall.

ASHRAE 90.1 remains the primary reference standard for energy codes adopted by states and local jurisdictions to regulate the design and construction of new buildings. The installation of continuous insulation over steel stud framing was first incorporated in the 1999 version of ASHRAE 90.1. The matrices shown below illustrate a summary of the code requirements active today for both non-residential and residential construction and the current building envelope requirements.

Prescriptive R (Minimum) Requirements for Steel-Framed Walls, Above Grade

ZONE	ASHRAE 90.1 2004		ASHRAE 90.1 2007 & 2010		ASHRAE 90.1 2013		IECC 2012 & 2015		ASHRAE 90.1 2016		IECC 2018	
	NON-RESIDENTIAL	RESIDENTIAL	NON-RESIDENTIAL	RESIDENTIAL	NON-RESIDENTIAL	RESIDENTIAL	NON-RESIDENTIAL	RESIDENTIAL	NON-RESIDENTIAL	RESIDENTIAL	NON-RESIDENTIAL	RESIDENTIAL
0	N/A	N/A	N/A	N/A	N/A	N/A	N/A	N/A	13	13	13	13
1	13	13	13	13	13	13	13 + 5.0	13 + 5.0	13	13	13	13
2	13	13	13	13 + 7.5	13 + 3.8	13 + 7.5	13 + 5.0	13 + 7.5	13 + 3.8	13 + 7.5	13 + 3.8	13 + 7.5
3	13	13 + 3.8	13 + 3.8	13 + 7.5	13 + 5.0	13 + 7.5	13 + 7.5	13 + 7.5	13 + 5	13 + 7.5	13 + 5	13 + 7.5
4	13	13 + 7.5	13 + 7.5	13 + 7.5	13 + 7.5	13 + 7.5	13 + 7.5	13 + 7.5	13 + 7.5	13 + 7.5	13 + 7.5	13 + 7.5
5	13 + 3.8	13 + 7.5	13 + 7.5	13 + 7.5	13 + 10.0	13 + 10.0	13 + 7.5	13 + 7.5	13 + 10	13 + 10	13 + 10	13 + 10
6	13 + 3.8	13 + 7.5	13 + 7.5	13 + 7.5	13 + 12.5	13 + 12.5	13 + 7.5	13 + 7.5	13 + 12.5	13 + 12.5	13 + 12.5	13 + 12.5
7	13 + 7.5	13 + 7.5	13 + 7.5	13 + 15.6	13 + 12.5	13 + 15.6	13 + 7.5	13 + 15.6	13 + 12.5	13 + 15.6	13 + 12.5	13 + 15.6
8	13 + 7.5	13 + 10	13 + 7.5	13 + 18.8	13 + 18.8	13 + 18.8	13 + 7.5	13 + 17.5	13 + 18.8	13 + 18.8	13 + 18.8	13 + 18.8

Note: where you see two figures shown, e.g., 13 + 7.5, the second value listed is the specific continuous insulation R-value required.

Current Building Envelope Requirements, ASHRAE 90.1 2019

ZONE	NON-RESIDENTIAL		RESIDENTIAL	
	ASSEMBLY MAX	INSULATION MIN. R-VALUE	ASSEMBLY MAX	INSULATION MIN. R-VALUE
0	U 0.124	13	U 0.124	13
1	U 0.124	13	U 0.124	13
2	U 0.084	13 + 3.8 c.i.	U 0.064	13 + 7.5 c.i.
3	U 0.077	13 + 5.0 c.i.	U 0.064	13 + 7.5 c.i.
4	U 0.064	13 + 7.5 c.i.	U 0.064	13 + 7.5 c.i.
5	U 0.055	13 + 10 c.i.	U 0.055	13 + 10 c.i.
6	U 0.049	13 + 12.5 c.i.	U 0.049	13 + 12.5 c.i.
7	U 0.049	13 + 12.5 c.i.	U 0.042	13 + 15.6 c.i.
8	U 0.037	13 + 18.8 c.i.	U 0.037	13 + 18.8 c.i.

OVERVIEW

Drivers of Continuous Insulation

Paths to Code Compliance

There are three typical paths to compliance. Perhaps the most commonly known path is the prescriptive method. In this method, the chart previously illustrated is used to select the construction type and climate zone, which will prescribe the R-value with continuous insulation required as well as overall assembly R-value.

Another path is the performance method, often used if the assembly is particularly complicated or requires further analysis. You'll also see this used on curtain walls and in WUFI analysis. Finally, the last method uses software and web tool calculators developed by the U.S. Department of Energy to compare a structure to a basis of design.

1. Prescriptive R-Value

- Considers R-value of insulation only.
- Compliance is achieved by installing insulation with code-prescribed R-value.

2. Performance (overall assembly)

- Considers:
 - U-factors: U-value of assembly (above grade).
 - C-factors: Thermal conductance (below grade).
 - F-factors: Slab edge factors.
- Compliance is achieved when assembly meets minimum U-value.
- Requires calculations or testing to demonstrate compliance but offers greater flexibility in system options.

3. Envelope Tradeoff

- Tightly defined.
- Allows for tradeoff between various parts of the building envelope.
- ASHRAE Standard 90.1-2007/2010 provides the basic rules.

Tradeoff is implemented in the COMcheck™ software.

Designing Beyond Codes

Many owners, designers, and contractors feel that the insulation requirements set out in state-adopted codes are not robust enough to truly save energy and reduce greenhouse gas emissions. These owners, designers, and contractors look beyond code initiatives to USGBC's LEED® rating system, ASHRAE Standard 189.1, Architecture 2030, Passive House, Title 24, Declare, or LL 97.

Including increased insulation levels in the building envelope can help reach these goals with a negative marginal cost, generating a positive economic return over the building's lifecycle.

Assembly Insulation Methods

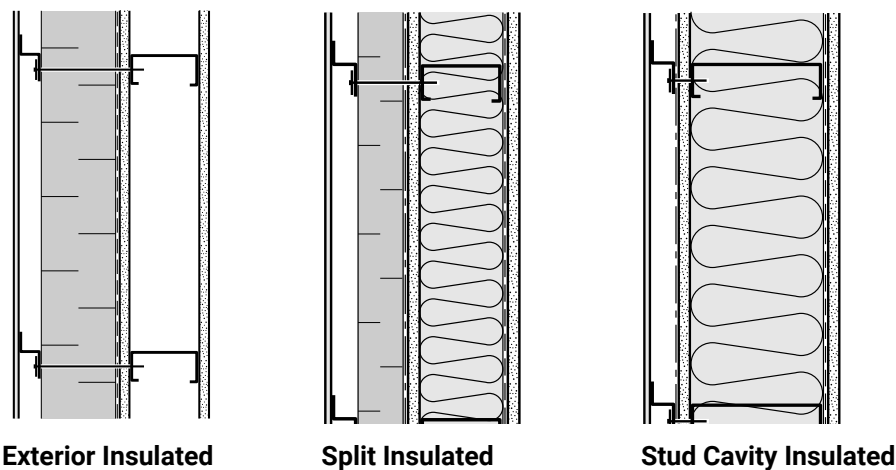

PRODUCT SELECTOR

Thermafiber® RainBarrier® Mineral Wool Continuous Insulation Portfolio

To realize the greatest thermal benefits of exterior continuous insulation, it must be installed in a way to minimize heat losses through the insulation layer. Owens Corning offers a portfolio of Thermafiber® RainBarrier® mineral wool continuous insulation products to address the growing need for continuous insulations to be used in a variety of applications and façade types. Moreover, Owens Corning® Thermafiber® RainBarrier® insulation products are water repellent, sustainable, provide fire and smoke protection, have thermal and acoustic control, and are easy to install. The consistent densities from top to bottom of our Thermafiber® RainBarrier® products help eliminate panel orientation during installation.

Semi-Rigid Portfolio

Thermafiber® RainBarrier® 45 and HD continuous insulation products are designed for exceptional performance in rain screen and cavity wall construction applications. Both products provide thermal performance, fire-resistive characteristics, and acoustical control while efficiently draining moisture from a wall cavity system. Thermafiber® RainBarrier® HD insulation is a high-density board with a consistent 6.0 pcf (lb./ft.³) density throughout the entire thickness of the product, providing additional thermal performance.



The Owens Corning® Thermafiber® RainBarrier® 45 and Owens Corning® Thermafiber® RainBarrier® HD products are also available with a black facer for aesthetic concealment. The black facer allows for aesthetic concealment and is ideal for open joint and perforated façade systems or any application where masking of the insulation layer is desired.

High Compressive Portfolio

According to research and modeling, one of the best installation methods to maximize the thermal and durability benefits of the exterior insulation is to affix the insulation with strapping over the insulation and attach the strapping through the insulation to the structure with fasteners. Thermafiber® RainBarrier® ci High Compressive insulation uses ThermaCrimp™ technology to make the highest compressive strength mineral wool continuous insulation on the market. These products are designed to be used behind any cladding type – including combustible and open-joint assemblies. The high compressive properties of these insulation products allow the cladding supports to be fastened outboard of the insulation with the cladding support fasteners penetrating the continuous insulation and secured back to the structure.

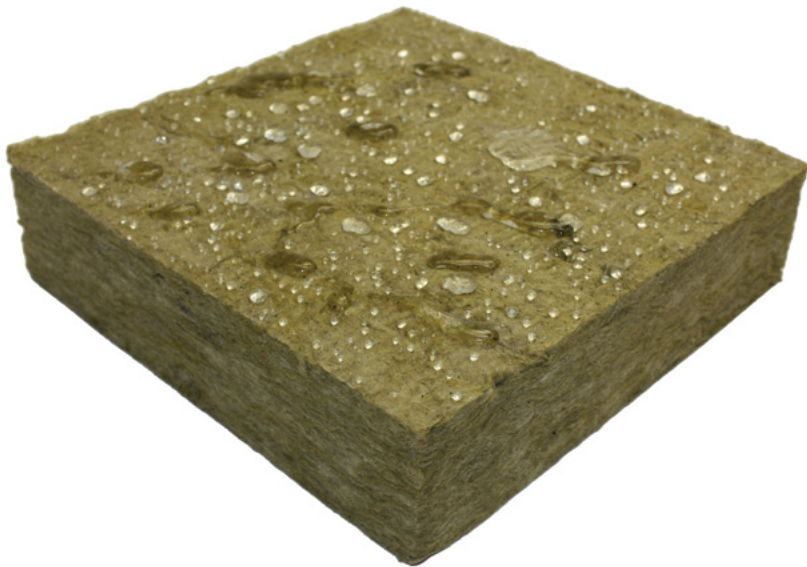

PRODUCT SELECTOR

Technical Data, Performance Attributes, and Attachment Methods*

SEMI-RIGID PORTOLIO	PRODUCT TECHNICAL DATA ⁶			
	ACTUAL DENSITY	"K" @ 75° [24°C] BTU IN./HR. SQ. FT. °F	"R" VALUE PER INCH OF THICKNESS ⁷	"U" VALUE PER INCH OF THICKNESS
Owens Corning® Thermafiber® RainBarrier® 45	4.5 pcf	0.23	4.3	0.23
Owens Corning® Thermafiber® RainBarrier® HD	6 pcf	0.23	4.3	0.23
Owens Corning® Thermafiber® RainBarrier® Dark™ 45	4.5 pcf	0.23	4.3	0.23
Owens Corning® Thermafiber® RainBarrier® Dark™ HD	6 pcf	0.23	4.3	0.23

HIGH COMPRESSIVE PORTFOLIO	PRODUCT TECHNICAL DATA ⁶				
	COMPRESSIVE STRENGTH ⁸	PSF	"K" @ 75° [24°C] BTU IN./HR. SQ. FT. °F	"R" VALUE PER INCH OF THICKNESS ⁷	"U" VALUE PER INCH OF THICKNESS
Owens Corning® Thermafiber® RainBarrier® ci High Compressive (80)	475 lbs./ft. ² @ 10% deformation	3 psi	0.24	4.2	0.24
Owens Corning® Thermafiber® RainBarrier® ci High Compressive Plus (110)	720 lbs./ft. ² @ 10% deformation	5 psi	0.24	4.2	0.24
Owens Corning® Thermafiber® RainBarrier® ci High Compressive Max	1,296 lbs./ft. ² @ 10% deformation	9 psi	0.24	4.2	0.24

*Product data sheets are available at owenscorning.com/rainbarrier.

⁶ Tested per ASTM C518, Standard Test Method for Steady-State Thermal Transmission Properties by Means of the Heat Flow Meter Apparatus, ASTM International.

⁷ R = product thickness divided by "k."

⁸ Tested per ASTM C165, Standard Test Method for Measuring Compressive Properties of Thermal Insulations, ASTM International.

RainBarrier® Product Comparison

		RAINBARRIER® 45	RAINBARRIER® HD	RAINBARRIER® DARK™ 45	RAINBARRIER® DARK™ HD	RAINBARRIER® HC (80)	RAINBARRIER® HC PLUS (110)	RAINBARRIER® HC MAX
	Product Type:	Semi-Rigid Board	Semi-Rigid Board	Semi-Rigid Board with Facer	Semi-Rigid Board with Facer	Rigid Sheathing Board	Rigid Sheathing Board	Rigid Sheathing Board
PROPERTIES	TEST METHOD							
Mineral Wool Standard	ASTM C612	Types IA, IB, IVA, IVB	Types IA, IB, II, III, IVA, IVB	Types IA, IB, IVA, IVB	Types IA, IB, II, III, IVA, IVB	Types IA, IB, II, III, IVA, IVB	Types IA, IB, II, III, IVA, IVB	Types IA, IB, II, III, IVA, IVB
Corrosion of Steel, Copper, Aluminum, and Copper	ASTM C665	Non-corrosive	Non-corrosive	Non-corrosive	Non-corrosive	Non-corrosive	Non-corrosive	Non-corrosive
Stress Corrosion - Austenitic Steel	ASTM C795	Pass						
Non-Combustibility	ASTM E136	Non-combustible						
Non-Combustibility	CAN/ULC S114	Non-combustible						
Water Vapor Permeance	ASTM E96	50 perm, unfaced	50 perm, unfaced	47 perm	38 perm	24 perm	46 perm	57 perm
Surface Burning Characteristics	ASTM E84	Flame Spread 0 Smoke Developed 0	Flame Spread 0 Smoke Developed 0	Flame Spread 20 Smoke Developed 15	Flame Spread 20 Smoke Developed 15	Flame Spread 0 Smoke Developed 0	Flame Spread 0 Smoke Developed 0	Flame Spread 0 Smoke Developed 0
Surface Burning Characteristics	CAN/ULC S102	Flame Spread 0 Smoke Developed 5	Flame Spread 0 Smoke Developed 5	-	-	Flame Spread 0 Smoke Developed 5	Flame Spread 0 Smoke Developed 5	Flame Spread 0 Smoke Developed 5
Water Vapor Sorption	ASTM C1104	Absorbs 0.03% by volume	Absorbs 0.03% by volume	Absorbs 0.06% by volume	Absorbs 0.06% by volume	Absorbs <1% by volume	Absorbs <0.5% by volume	Absorbs <0.5% by volume
Linear Shrinkage	ASTM C356	<2% @ 1200°F (650°C)						

ATTACHMENT METHODS

Cladding attachment around insulation: • Brick Ties • Girts (metal or thermally short) • Channels • Clips & Rails (metal or thermally short)	Preferred	Preferred	Preferred when camouflaging is needed	Preferred when camouflaging is needed				
Cladding attachment outboard of insulation (i.e., throughput fasteners, nails, screws)					Preferred when using light-weight cladding	Preferred when using medium-weight cladding	Preferred when using heavy-weight cladding	

PRODUCT SELECTOR

Cladding Attachment

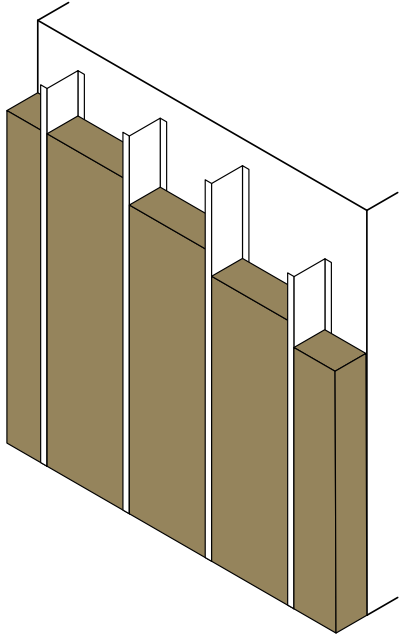
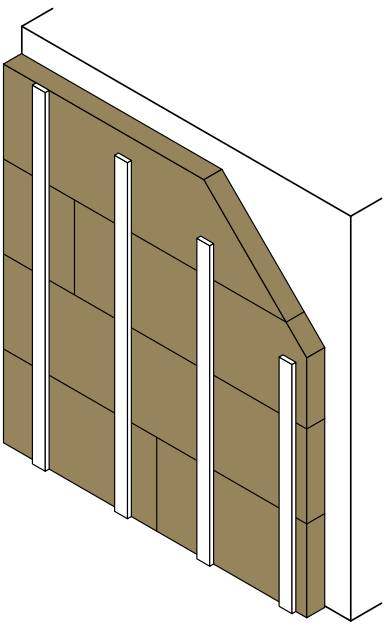
Owens Corning® Thermafiber® Products by Cladding Attachment		
CLADDING ATTACHMENT	MINERAL WOOL INSULATION IS INSTALLED BETWEEN CLADDING ATTACHMENT	CLADDING ATTACHMENTS ARE INSTALLED OUTBOARD OF THE MINERAL WOOL INSULATION
	SEMI-RIGID	HIGH COMPRESSIVE
PRODUCTS	<p>Owens Corning® Thermafiber® RainBarrier® 45 Owens Corning® Thermafiber® RainBarrier® HD Owens Corning® Thermafiber® Rainbarrier® Dark™ 45 Owens Corning® Thermafiber® Rainbarrier® Dark™ HD</p> 	<p>Owens Corning® Thermafiber® RainBarrier® ci High Compressive (80) Owens Corning® Thermafiber® RainBarrier® ci High Compressive Plus (110) Owens Corning® Thermafiber® RainBarrier® ci High Compressive Max</p> 

PRODUCT SELECTOR

Cladding Weight for High Compressive Products

Owens Corning® Thermafiber® Products by Cladding Weight		
HIGH COMPRESSIVE	CLADDING ASSEMBLY	CLADDING WEIGHT
RainBarrier® ci High Compressive (80)	For use where the cladding supports are installed outboard of the mineral wool insulation in light weight cladding assemblies.	Light Weight Cladding < 5 lbs./sq.ft.
RainBarrier® ci High Compressive Plus (110)	For use where the cladding supports are installed outboard of the mineral wool insulation in medium weight cladding assemblies.	Medium Weight Cladding 5 lbs./sq.ft. to ≤ 10 lbs./sq.ft.
RainBarrier® ci High Compressive Max	For use where the cladding supports are installed outboard of the mineral wool insulation in heavy weight cladding assemblies.	Heavy Weight Cladding > 10 lbs./sq.ft. to < 15 lbs./sq.ft.

General Cladding Weight Classification

(5 lbs./ft.² increments)

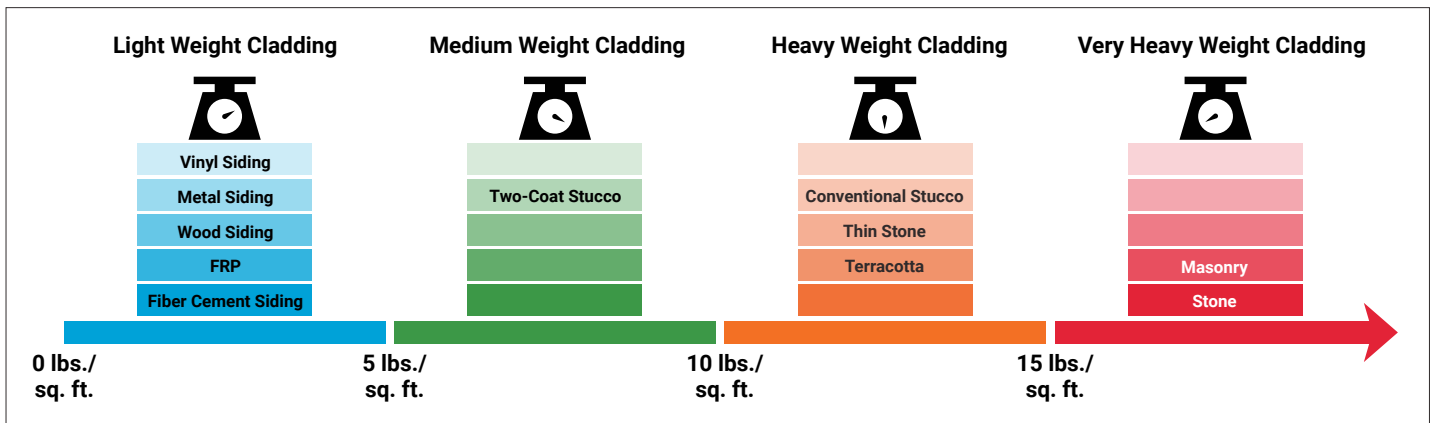

Note: Very heavy cladding materials, such as stone, should be evaluated on a project basis unless self-supporting.

ATTACHMENT AND SUPPORT

Common Support Methods

Attachment Method

	RAINBARRIER® 45 & RAINBARRIER® DARK™ 45	RAINBARRIER® HD & RAINBARRIER® DARK™ HD	RAINBARRIER® HIGH COMPRESSIVE (80)	RAINBARRIER® HIGH COMPRESSIVE PLUS (110)	RAINBARRIER® HIGH COMPRESSIVE MAX
Mineral wool insulation is installed between cladding attachments.	Preferred	Preferred ⁹			
Cladding attachments are fastened outboard of the mineral wool insulation.			Light Weight Cladding < 5 lbs./sq.ft.	Medium Weight Cladding 5 lbs./sq.ft. to ≤ 10 lbs./sq.ft.	Heavy Weight Cladding > 10 lbs./sq.ft. to < 15 lbs./sq.ft.

STRAPPING

Strapping members are typically installed outboard of the insulation and attached through the insulation to the building structure or backup wall framing. The attached strapping members clamp the insulation in place.

- Treated wood or metal strapping may be used.
- For wood, use min. ¾ in. dimensional lumber.
- For metal, use min. 25 gauge⁹, 7/8 in. or 1 ½ in. hat channel with min. G40 coating or a coating that provides equivalent corrosion resistance.
- Install wood strapping vertically to facilitate drainage.
- Install metal strapping vertically to facilitate drainage, or utilize furring channels with integral drainage capacity measured per ASTM E2273.

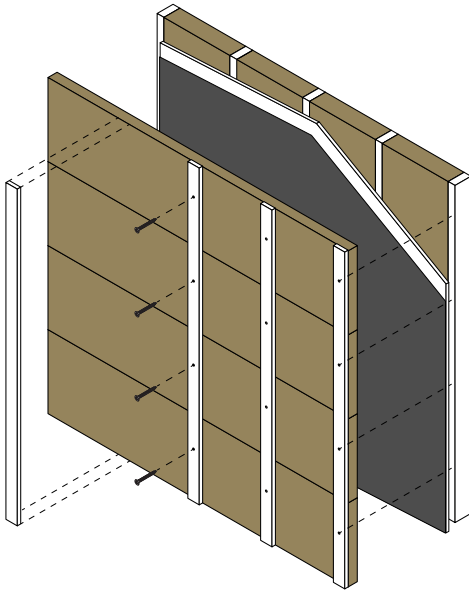

Z-FURRING CHANNELS

Z-Furring channels are typically installed to the building structure or backup wall framing.

- Install Z-Furring channels horizontal to facilitate drainage.
- Use min. 25 gauge⁹, with min. G40 coating or a coating that provides equivalent corrosion resistance.
- Install shorter flange of Z-Furring channels to the building structure.

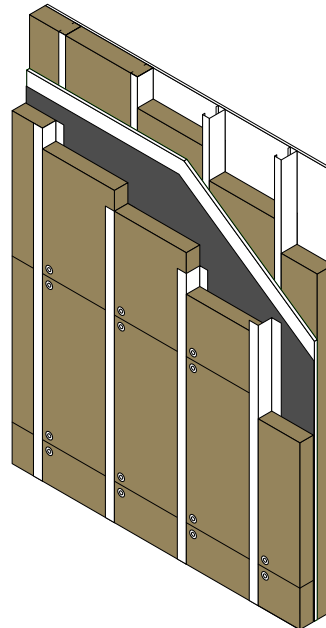

⁹ Rainbarrier® HD may be used where additional rigidity is preferred by the installer.

ATTACHMENT AND SUPPORT

Common Support Methods

MASONRY TIES

Various clips and wedges can be used with masonry ties to attach Owens Corning® Thermafiber® RainBarrier® insulation boards.

Common or specialty ties can be used, as the semi-rigid mineral wool insulation will conform around the ties.

- When allowed by code and structural design, space ties 16 in. or 24 in. in at least one orientation, vertically or horizontally, to allow for the installation of the insulation boards.
- Clips or wedges used with masonry ties can hold the insulation in place at the insulation board edges. Additional fasteners may be used in the field of insulation boards if needed.

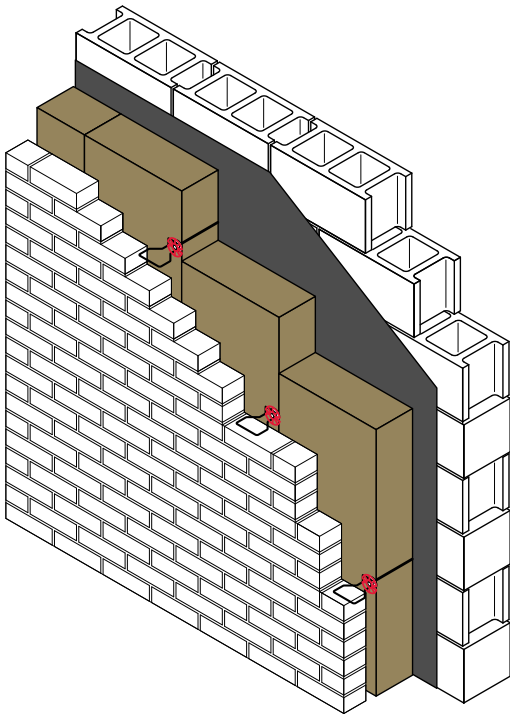
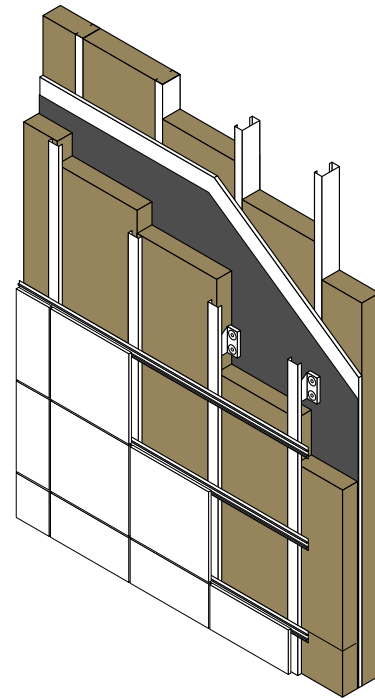

Illustration shows the use of Thermafiber® RainBarrier® Clips.

CLIP AND RAIL SYSTEMS

Clip and rail systems are typically installed to the building structure or backup wall framing. The insulation is installed between the system components.

- When using proprietary clip and rail systems, use the manufacturer's recommended fasteners for attachment.
- Follow manufacturer's guidelines for any support of the insulation boards provided by the system components.



ATTACHMENT AND SUPPORT

Fasteners

General Fastener Guidance

Without proper attachment, the thermal performance of the continuous insulation is compromised. Fasteners function to keep insulation flush with the substrate in a continuous fashion for the intended life of the structure. Fastener type and specifications depend on the material receiving the attachment.

For wood framing or sheathing, exterior grade¹⁰ (stainless steel or galvanized) screws or impaling pins are recommended. For steel framing, exterior grade steel fasteners are recommended. For concrete or masonry, masonry anchors or fasteners are recommended.

To mitigate the risk of adhesive-based failure, the use of adhesive-based fasteners should be limited to temporary attachment.

It is generally recommended to utilize a minimum 2-inch washer and ensure the fastener penetrates a minimum 1-inch into the receiving stud or structural material. In general, nails are not recommended for use with insulation greater than 4 inches thick.

The type of fastener, method, and frequency is to be determined by the project design team for the specificity of the project. Mechanical fasteners are recommended for long-term performance of insulation and to mitigate the risk of adhesive-based failure.

NOTE: Thermafiber® RainBarrier® mineral wool continuous insulation is designed for mechanical attachment. Thermafiber® Impasse® Hangers and Thermafiber® RainBarrier® Clips are proprietary fasteners that can be utilized. TRUFAST® Walls¹¹ produces a line of specialty fasteners for mineral wool, such as their Thermal-Grip® Impaling Fastener and Grip-Lok® MW Plate.

Other Considerations

Numerous other project factors should be considered by the architect or engineer of record, such as static loads, wind loads, seismic loads, and all combined loads.

It is always good practice to check with the exterior cladding manufacturer if they have any special attachment requirements due to load factors or other performance requirements.

¹⁰ Fasteners used to attach the cladding support materials through the mineral wool continuous insulation should be exterior grade, stainless steel or galvanized, and tested per ASTM B117, to ensure long-term durability in an exterior environment. Ensure the fastener is compatible with both the cladding support materials and the cladding.

¹¹ TRUFAST® Walls is a division of Altenloh, Brinck & Co. U.S., Inc. Please visit www.trufast.com for more information.

ATTACHMENT AND SUPPORT

Common Fastener Types

Plastic Cap Nails

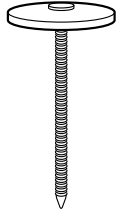

Impaling Pins

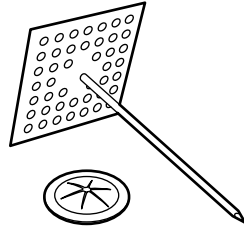

Standard Screws and Concrete Nails

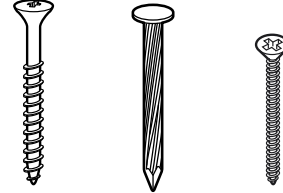

Dual-Thread Fasteners

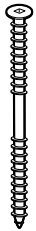

Fastener and Washer

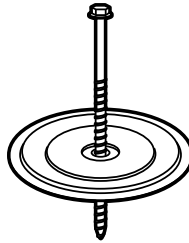

Insulation Fasteners

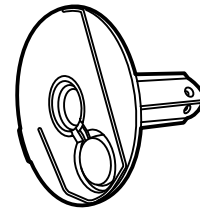

Owens Corning® Thermafiber® Impasse® Hangers

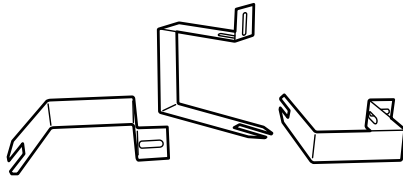

Impasse® Hangers

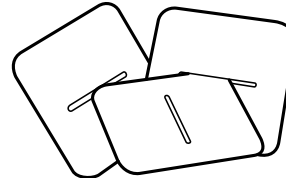

Impasse® Locking Washer

Clip and Rail Systems

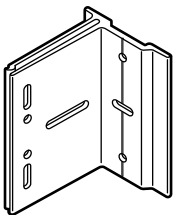

CL-Talon

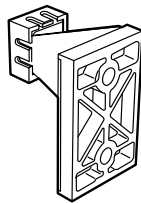

Knight Wall Systems

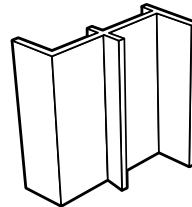

Smartci GreenGirt™

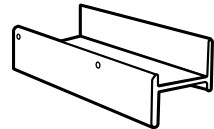

Strongwell STRONGIRT™

Wall Tie Clips and Anchors

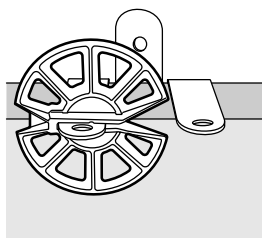

Thermafiber® RainBarrier® Clip

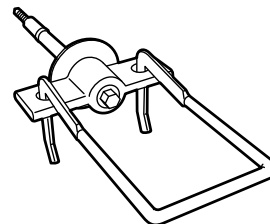

Barrel-Style Masonry Anchor

ATTACHMENT AND SUPPORT

Fastener Placement

16 in. x 48 in. Panel with 4 Fasteners

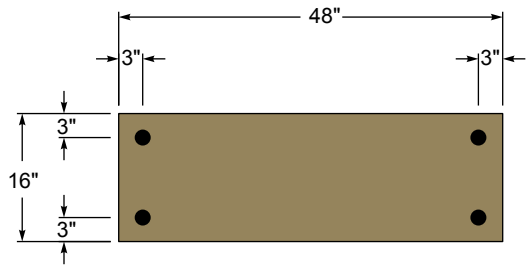

36 in. x 48 in. Panel with 5 Fasteners

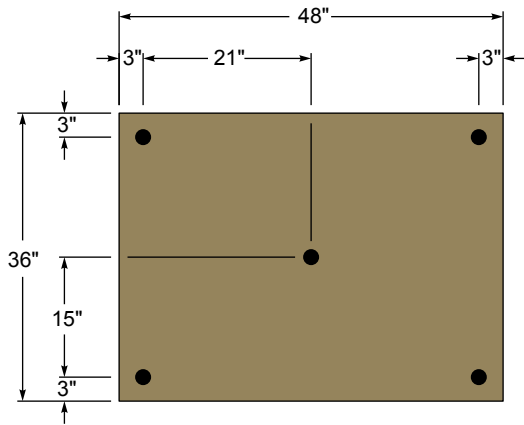

24 in. x 48 in. Panel with 4 Fasteners

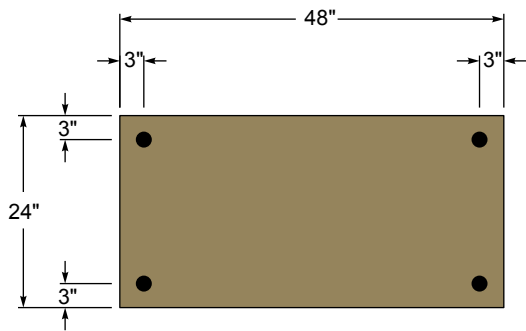

36 in. x 60 in. Panel with 6 Fasteners

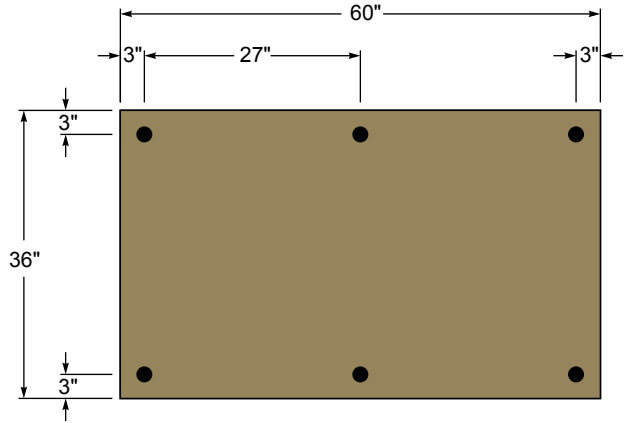

24 in. x 48 in. Panel with 5 Fasteners

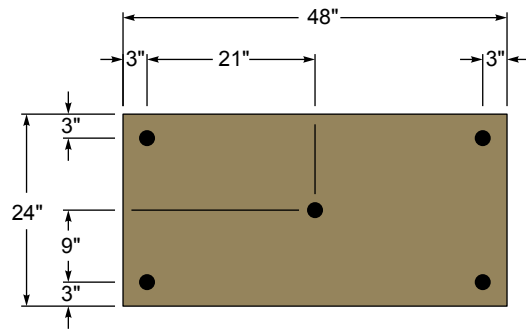

ATTACHMENT AND SUPPORT

Panel Layout

12 in. on Center Support Spacing
5 Fasteners per Board

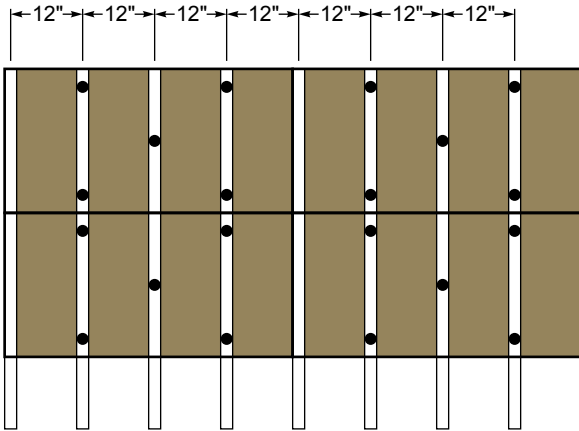

16 in. on Center Support Spacing
5 Fasteners per Board
Board Edges Offset 8 in. from Supports

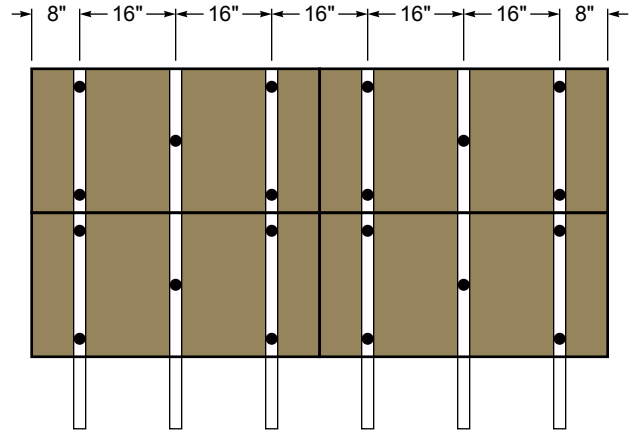

Multilayer Application Guide

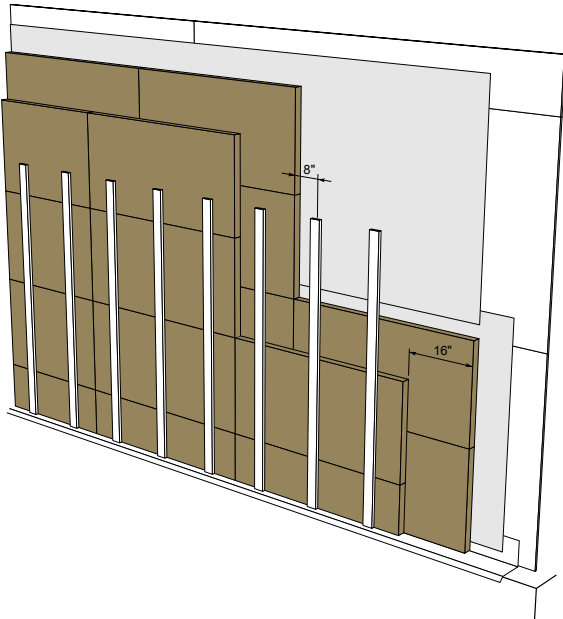

24 in. on Center Support Spacing
4 Fasteners per Board
Board Edges Offset 12 in. from Supports

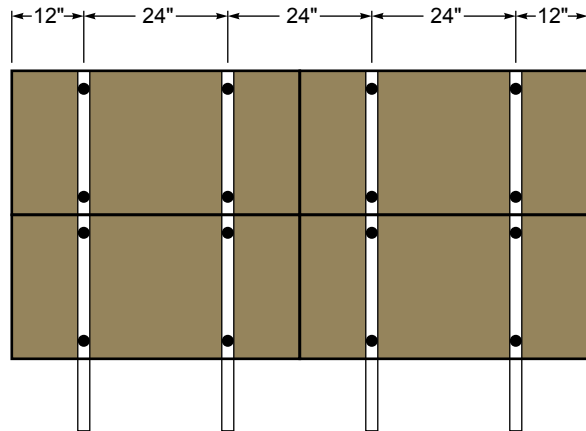

ATTACHMENT AND SUPPORT

Installation of Mineral Wool Insulation

Mineral wool insulation is installed between cladding attachments

QUANTITY OF FASTENERS PER PANEL	PANEL THICKNESS	PANEL WIDTH	PANEL LENGTH
4	1" to 4"	16"	48"
4	1" to 3"	24"	48"
5	4"	24"	48"
6	1" to 4"	36"	48" or 60"

Mineral wool insulation is installed between Z-Furring Channel

QUANTITY OF FASTENERS PER PANEL	PANEL THICKNESS	PANEL WIDTH	PANEL LENGTH
2	1" to 3"	16"	48"
2	1" to 2"	24"	48"
2	1"	36"	48" or 60"
3	3 1/2" to 4"	16"	48"
3	3" to 4"	24"	48"
3	1 1/2" to 4"	36"	48" or 60"

Notes:

- Impaling pins may be installed prior to the air and water barrier.
- The shorter flange of the channel is typically installed to the wall substrate and receives insulation fastener.
- The longer flange of the channel is typically installed to the exterior to grip the insulation in place.
- Owens Corning® Thermafiber® Impasse® Hangers are available in vertical and horizontal versions from 2" to 5" in 1/2" increments. Custom sizes available.

Z-Furring Channel Layouts

Two-Fastener, Vertical Applications

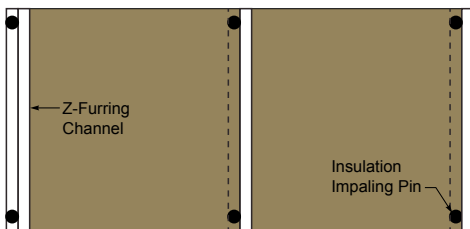

Two-Fastener, Horizontal Applications

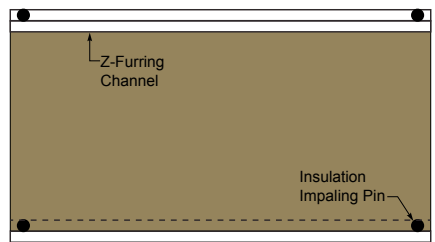

Three-Fastener, Vertical Applications

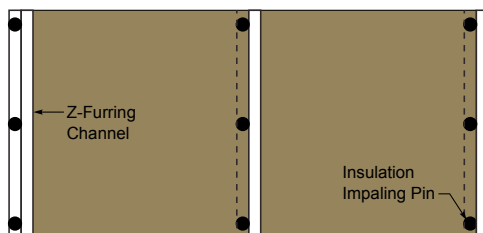

Three-Fastener, Horizontal Applications

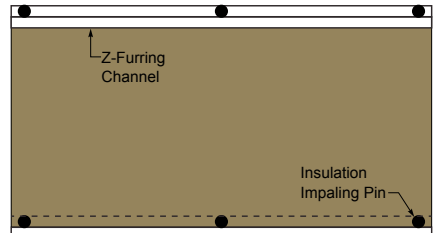

Note: For horizontal applications, utilize furring channels with integral drainage capacity measured per ASTM E2273.

ATTACHMENT AND SUPPORT

Installation of Mineral Wool Insulation

Z-Furring Channels with Owens Corning® Thermafiber® Impasse® Hangers

Owens Corning® Thermafiber® Impasse® Hangers attach directly to Z-Furring channels, eliminating any penetration of the water-resistive barrier (WRB). Due to the “shelf” they provide, they are also much more effective at eliminating crushing of the panels on the bottom of the structure. They can also be installed on the panels and then set into place, eliminating the need to pre-install impaling pins to the structure, and then installing the insulation over the pins. This saves time during the installation.

Z-Furring Channels with Impasse Hangers

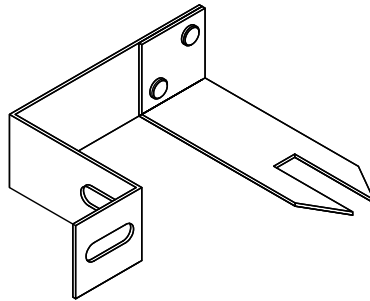
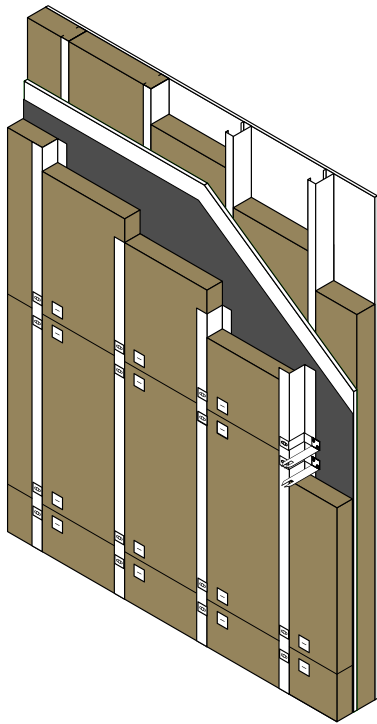

Prior to insulation installation

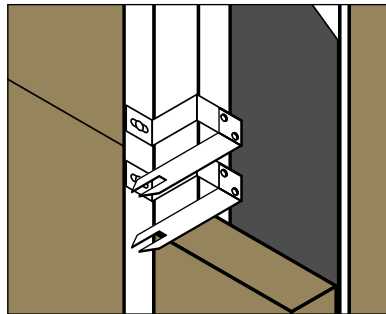

Post insulation installation

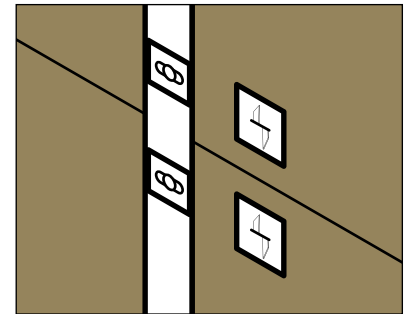

Clip and Rail Systems

Owens Corning® Thermafiber® RainBarrier® continuous insulation is compatible with virtually any cladding system in the industry, including specialty thermally isolated clip and rail systems. These thermally isolated clips and systems reduce thermal bridging between the cladding and the wall, improving the effective R-value of the insulation.

Thermally Isolated Clip and Rail Systems

- CL-Talon
- Knight Wall Systems
- SMARTci GreenGirt™
- Strongwell STRONGIRT™

ATTACHMENT AND SUPPORT

Mineral Wool Insulation with Concrete, CMU, and Brick

RainBarrier® 45 and RainBarrier® HD insulation can either be impaled onto shelf-type wall ties or installed so wall ties occur at insulation seams. When fit between wall ties, the insulation is secured to the wall tie with Thermafiber® RainBarrier® Clips or wall tie anchors. When installing masonry veneers, RainBarrier® 45 and RainBarrier® HD continuous insulation can be attached using the single-barrel masonry anchors with minimum 2-inch washers.

Shelf-Type Wall Ties

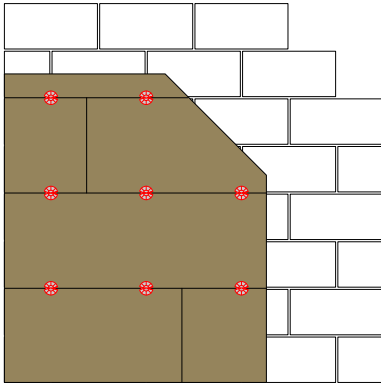

Screw and Washer

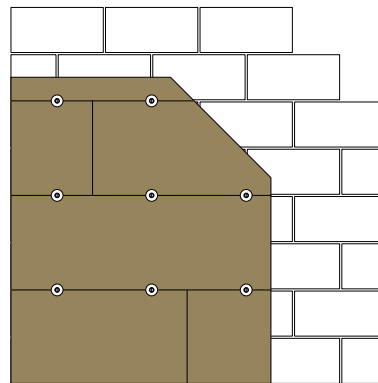

Masonry Ties

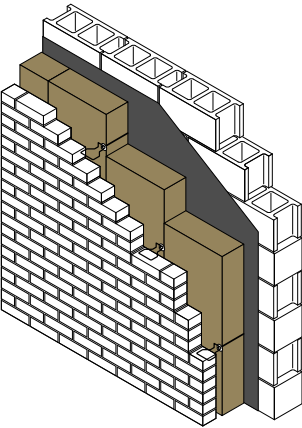

Brick Veneer Anchor Ties

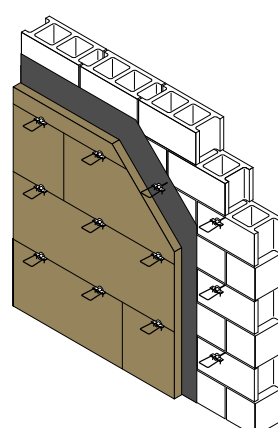

Typical Wall Ties

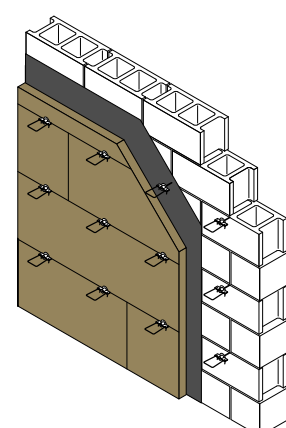

Typical Wall Ties with Thermafiber® RainBarrier® Clips

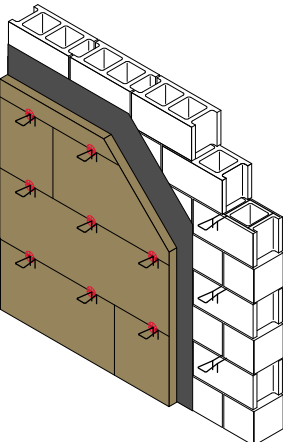

Shelf-Type Wall Ties with Thermafiber® RainBarrier® Clips

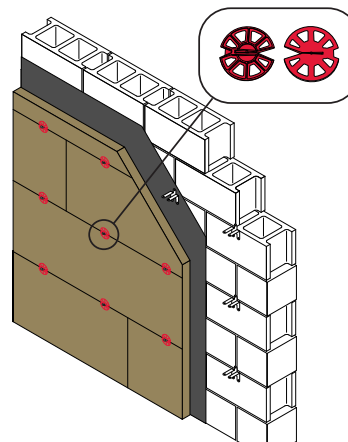

ATTACHMENT AND SUPPORT

Cladding Assemblies by Weight

Fastener and Furring/Girt Recommendations for Light Weight Cladding Assemblies

Light Weight Cladding Assemblies < 5 lbs./sq.ft.						
HIGH COMPRESSIVE INSULATION	BACKUP WALL FRAMING SPACING	INSULATION THICKNESS	MIN. SCREW SIZE	MAX. VERTICAL SCREW SPACING	MIN. SCREW PENETRATION INTO RECEIVING STUD ¹²	MIN. STRAPPING SIZE
Owens Corning® Thermafiber® RainBarrier® ci High Compressive (80)	16" oc	1 1/2" or 2"	#10	24"	1"	3/8" x 2 1/2"
		2 1/2" to 4"	#10	16"	1"	3/8" x 2 1/2"
	24" oc	1 1/2" or 2"	#10	24"	1"	3/8" x 2 1/2"
		2 1/2" to 4"	#10	16"	1"	3/8" x 2 1/2"

Fastener and Furring/Girt Recommendations for Medium Weight Cladding Assemblies

Medium Weight Cladding Assemblies 5 lbs./sq.ft. to ≤ 10 lbs./sq.ft.						
HIGH COMPRESSIVE INSULATION	BACKUP WALL FRAMING SPACING	INSULATION THICKNESS	MIN. SCREW SIZE	MAX. VERTICAL SCREW SPACING	MIN. SCREW PENETRATION INTO RECEIVING STUD ¹²	MIN. STRAPPING SIZE
Owens Corning® Thermafiber® RainBarrier® ci High Compressive Plus (110)	16" oc	1 1/4" or 1 1/2" to 4"	#12	16"	1 1/4"	1/2" x 3 1/2"
		3 1/2" to 7"	#12	12"	1 1/4"	1/2" x 3 1/2"
	24" oc	1 1/4" or 1 1/2" to 4"	#12	12"	1 1/4"	1/2" x 3 1/2"
		3 1/2" to 7"	#12	8"	1 1/4"	1/2" x 3 1/2"

Fastener and Furring/Girt Recommendations for Heavy Weight Cladding Assemblies

Heavy Weight Cladding Assemblies > 10 lbs./sq.ft. to < 15 lbs./sq.ft.						
HIGH COMPRESSIVE INSULATION	BACKUP WALL FRAMING SPACING	INSULATION THICKNESS	MIN. SCREW SIZE	MAX. VERTICAL SCREW SPACING	MIN. SCREW PENETRATION INTO RECEIVING STUD ¹²	MIN. STRAPPING SIZE
Owens Corning® Thermafiber® RainBarrier® ci High Compressive Max	16" oc	1" to 2"	#14	16"	1 1/2"	3/8" x 2 1/2"
		2 1/2" to 4"	#14	12"	1 1/2"	3/8" x 2 1/2"
	24" oc	1" to 2"	#14	10"	1 1/2"	3/8" x 2 1/2"
		2 1/2" to 4"	#14	8"	1 1/2"	3/8" x 2 1/2"

Fastener and Furring

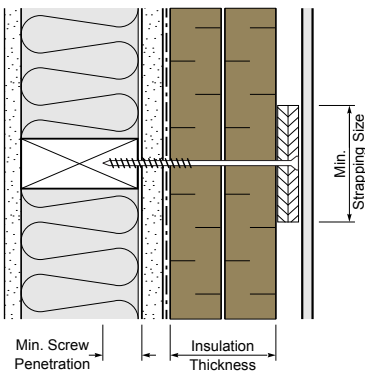

¹² Minimum penetration depth figures are shown for wood studs. For steel studs, minimum penetration depth shall be three (3) thread lengths from the back of the steel stud flange.

ATTACHMENT AND SUPPORT

Deflection Testing

Owens Corning sponsored a laboratory study to quantify the relationship between cladding gravity loads and deflection under short-term cladding weights of up to approximately 1,000 pounds of total load or 30 pounds per square foot (PSF) on wall assemblies. Test results demonstrated that deflection was less than 1/16 of an inch at 43 lbs./fastener, in excess of what would be expected from wood-framing shrinkage and environmental effects on a typical building. The results are summarized in the table below.

Deflection Testing Summary

TEST LOAD APPLIED	LOAD APPLIED (LBS./SQ.FT.) ¹³	LOAD APPLIED (LBS./FASTENER)	ASSOCIATED CLADDING WEIGHT CLASSIFICATION	RECOMMENDED CI PRODUCTS
100 lbs.	3.1	7.1	Light Weight Cladding < 5 lbs./sq.ft.	Owens Corning® Thermafiber® RainBarrier® ci High Compressive (80)
200 lbs.	6.2	14.3	Medium Weight Cladding 5 lbs./sq.ft. to ≤ 10 lbs./sq.ft.	Owens Corning® Thermafiber® RainBarrier® ci High Compressive Plus (110)
300 lbs.	9.4	21.4		
400 lbs.	12.5	28.6	Heavy Weight Cladding > 10 lbs./sq.ft. to < 15 lbs./sq.ft.	Owens Corning® Thermafiber® RainBarrier® ci High Compressive Max
500 lbs.	15.6	35.7	Very heavy cladding materials, such as stone, should be evaluated on a project basis unless self-supporting.	Very heavy cladding materials, such as stone, should be evaluated on a project basis unless self-supporting.
600 lbs.	18.8	42.9		
700 lbs.	21.9	50.0	Extreme/Experimental Loading	
800 lbs.	25.0	57.1		
900 lbs.	28.1	64.3		
1,000 lbs.	31.2	71.4		

¹³ Load applied per sq. ft. shown because it is more easily comparable to approximate cladding loads.

ATTACHMENT AND SUPPORT

Stacking Guidance

The overall dead load of the cladding along with project’s live loads will generally govern the attachment structural requirements. In tall, multistory projects, load-bearing lateral supports, shelf angles, or similar supports may also be utilized in the structural design, even when considering the attachment of continuous insulation. Though research has shown system creep to be minimal, design considerations of certain projects may require intermediary structural supports to transfer accumulated dead loads back to the structure. Load studies have demonstrated that every 7 pounds of dead load per fastener equates to approximately 100 pounds of total dead load. The product weights of all Owens Corning® Thermafiber® RainBarrier® continuous insulation products are provided to help determine if shelf angles or similar supports should be considered. If load-bearing lateral supports are determined to be necessary, care shall be taken to ensure no degradation to other performance requirements, such as fire safety, water management, and thermal bridging.

Lateral Support Examples

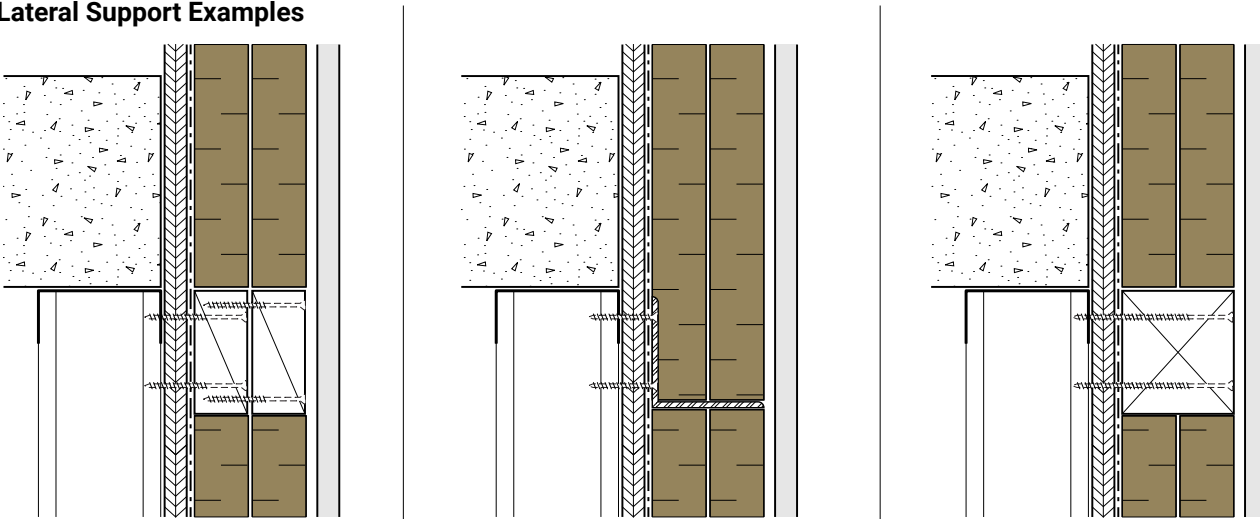

Thermafiber® Continuous Insulation Product Weight

INSULATION THICKNESS	RAINBARRIER® 45	RAINBARRIER® HD	RAINBARRIER® HIGH COMPRESSIVE (80)	RAINBARRIER® HIGH COMPRESSIVE PLUS (110)	RAINBARRIER® HIGH COMPRESSIVE MAX
1 in.	0.38 lbs./ft. ²	0.50 lbs./ft. ²	N/A	N/A	0.92 lbs./ft. ²
1.25 in.	N/A	N/A	N/A	0.83 lbs./ft. ²	N/A
1.5 in.	0.56 lbs./ft. ²	0.75 lbs./ft. ²	0.88 lbs./ft. ²	1.00 lbs./ft. ²	1.38 lbs./ft. ²
2 in.	0.75 lbs./ft. ²	1.00 lbs./ft. ²	1.17 lbs./ft. ²	1.33 lbs./ft. ²	1.83 lbs./ft. ²
2.5 in.	0.94 lbs./ft. ²	1.25 lbs./ft. ²	1.46 lbs./ft. ²	1.67 lbs./ft. ²	2.29 lbs./ft. ²
3 in.	1.13 lbs./ft. ²	1.50 lbs./ft. ²	1.75 lbs./ft. ²	2.00 lbs./ft. ²	2.75 lbs./ft. ²
3.5 in.	1.31 lbs./ft. ²	1.75 lbs./ft. ²	2.04 lbs./ft. ²	2.33 lbs./ft. ²	3.21 lbs./ft. ²
4 in.	1.50 lbs./ft. ²	2.00 lbs./ft. ²	2.33 lbs./ft. ²	2.67 lbs./ft. ²	3.67 lbs./ft. ²
4.5 in.	1.69 lbs./ft. ²	2.25 lbs./ft. ²	N/A	3.00 lbs./ft. ²	N/A
5 in.	1.88 lbs./ft. ²	2.50 lbs./ft. ²	N/A	3.33 lbs./ft. ²	N/A
5.5 in.	2.06 lbs./ft. ²	2.75 lbs./ft. ²	N/A	3.67 lbs./ft. ²	N/A
6 in.	2.25 lbs./ft. ²	3.00 lbs./ft. ²	N/A	4.00 lbs./ft. ²	N/A
6.5 in.	2.44 lbs./ft. ²	3.25 lbs./ft. ²	N/A	4.33 lbs./ft. ²	N/A
7 in.	2.63 lbs./ft. ²	3.50 lbs./ft. ²	N/A	4.67 lbs./ft. ²	N/A

Note: Attachments shall be designed to withstand all combined applied loads, including wind loads and dead loads (insulation, fasteners, all cladding and cladding support materials).

ATTACHMENT AND SUPPORT

Span Tables for High Compressive Products

Span table guidance for three typical exterior insulated wall assemblies using:

- Owens Corning® Thermafiber® RainBarrier® ci High Compressive (80)
- Owens Corning® Thermafiber® RainBarrier® ci High Compressive Plus (110)
- Owens Corning® Thermafiber® RainBarrier® ci High Compressive Max

The intent of these span tables is to provide guidance when using and specifying Owens Corning® Thermafiber® RainBarrier® ci High Compressive insulation products where the cladding supports are fastened outboard of the insulation with the cladding support fasteners penetrating the continuous insulation and secured back to the structure.

The span tables provide minimum fastener spacing guidance based on international code requirements for a variety of horizontal and vertical furring, backup walls, and insulation type configurations under different wind load and dead load combinations.

Span table guidance is provided from the following: a detailed review of structural code requirements (International Building Code 2018), physical product and load testing, research from published reports, such as the 2014 United States Department of Energy (DOE) report titled "Initial and Long-Term Movement of Cladding Installed Over Exterior Rigid Insulation," and finite-element analysis (FEA) of the assemblies.

Note: Numerous other project factors should be considered by the architect or engineer of record, including various static, dynamic, and cyclical structural loads, such as system dead loads, wind loads, seismic loads, and all combined loads.

The variables included in the span tables are presented below:

HIGH COMPRESSIVE INSULATION	BACKUP WALL FRAMING	INSULATION THICKNESS	FURRING/GIRT TYPE	FASTENER TYPE	FURRING/GIRT SPACING
Owens Corning® Thermafiber® RainBarrier® ci High Compressive (80)	2" x 4" Wood Studs	1.5", 2", and 4"	Vertical ¾" x 2½"	#8 Self-Tapping Wood Screw	16"
Owens Corning® Thermafiber® RainBarrier® ci High Compressive Plus (110)	16 Gauge Steel Studs	1.25", 2", and 4"	Horizontal 7/8" min. 20 Gauge Hat Channel	#8 Self-Tapping Steel Screw	24"
Owens Corning® Thermafiber® RainBarrier® ci High Compressive Max	16 Gauge Steel Studs	1", 2", and 4"	Horizontal 7/8" min. 20 Gauge Hat Channel	#8 Self-Tapping Steel Screw	24"

Material Properties and Reference Values

COMPONENT	PROPERTY	VALUE
Wood Furring	Wood Type	Alaskan Cedar No. 2
	Size	¾" x 2½"
Steel Girts	Steel Grade	ASTM 792 Grade 33
	Yield Strength	33 ksi
	Ultimate Strength	45 ksi
Backup Wall Steel Studs	Steel Grade	ASTM 792 Grade 33
	Gauge	16
Backup Wall Wood Studs	Wood Type	Spruce Pine Fur No. 2
	Size	2" x 4"
#8 Self-Tapping Screws	Design Pull-Out (Tension)	67.5 lbf.
	Design Bearing (Shear)	30.4 lbf.
Stud Wall Fastener	Design Pull-Out (Tension)	130.7 lbf.

ATTACHMENT AND SUPPORT

Span Tables for High Compressive Products

MAXIMUM FASTENER SPACINGS¹⁴
OWENS CORNING® THERMAFIBER® RAINBARRIER® CI HIGH COMPRESSIVE (80) DEFLECTION CRITERIA: L/240

WIND LOAD (PSF)	INSULATION THICKNESS	MAXIMUM FASTENER SPACING (IN.) DEAD LOAD			
		3 PSF	5 PSF	10 PSF	15 PSF
20	1.5"	32	22	12	8
	2"	29	20	10	7
	4"	22	14	7	4
30	1.5"	26	20	11	8
	2"	24	18	10	7
	4"	19	13	7	4
40	1.5"	21	17	11	7
	2"	20	16	10	7
	4"	17	12	7	4

MAXIMUM FASTENER SPACINGS¹⁴
OWENS CORNING® THERMAFIBER® RAINBARRIER® CI HIGH COMPRESSIVE PLUS (110) DEFLECTION CRITERIA: L/240

WIND LOAD (PSF)	INSULATION THICKNESS	MAXIMUM FASTENER SPACING (IN.) DEAD LOAD			
		3 PSF	5 PSF	10 PSF	15 PSF
20	1.25"	46	29	15	10
	2"	37	23	12	8
	4"	24	15	8	5
30	1.25"	43	28	15	10
	2"	35	22	12	8
	4"	24	15	8	5
40	1.25"	41	27	14	10
	2"	34	22	11	8
	4"	23	14	7	5

MAXIMUM FASTENER SPACINGS¹⁴
OWENS CORNING® THERMAFIBER® RAINBARRIER® CI HIGH COMPRESSIVE MAX DEFLECTION CRITERIA: L/240

WIND LOAD (PSF)	INSULATION THICKNESS	MAXIMUM FASTENER SPACING (IN.) DEAD LOAD			
		3 PSF	5 PSF	10 PSF	15 PSF
20	1"	49	31	16	10
	2"	36	22	11	7
	4"	24	14	7	5
30	1"	46	30	15	10
	2"	35	22	11	7
	4"	23	14	7	5
40	1"	44	29	15	10
	2"	33	21	11	7
	4"	22	14	7	5

¹⁴ Assumes studs spaced 16 in. oc with a single fastener from furring into each stud.

OTHER CONSIDERATIONS

Exposure

Weathering

Owens Corning® Thermafiber® RainBarrier® mineral wool insulation products are designed to handle exposure during the normal construction cycle where the insulation is being installed ahead of the building's façade. During this time, it is expected that our insulation will be exposed to the normal environmental elements, such as moisture, periodic rain, and snow. RainBarrier® insulation products are designed to handle this normal exposure and absorb less than 0.03% moisture by volume. If the exterior wall system is properly designed to handle moisture drainage within the assembly, then any additional moisture that penetrates the insulation will drain out of the material and allow it to dry out.

When exposed to weather, RainBarrier® insulation products will remain installed when using the proper method of mechanical attachment to a solid substrate. It is not recommended for insulation to be exposed to extreme weather conditions, such as natural disasters, flooding, hurricanes, tornadoes, high winds, torrential downpours, and blizzard conditions. Also, insulation should not be left exposed to rushing or running water resulting from a lack of gutter or soffit systems.

If the material remains in place, and is not dislodged, removed, or mechanically damaged, the properties of the insulation will be maintained, provided that the drainage noted above occurs.

If the above expected conditions are met, Owens Corning® Thermafiber® RainBarrier® insulation products can be exposed for 90 days without adversely affecting the product with unfaced materials, and 30 days with faced materials.

Drying and Maintenance of Performance

Owens Corning conducted tests to determine the performance of continuous insulation after exposure to moisture and subsequent drying. Testing was conducted for thermal conductivity ratings per ASTM C518 on a dry piece of curtain wall insulation. The insulation was submerged in water for an extended time period (88 hours) to allow the material to become completely saturated. The insulation was then allowed to dry. When dry, the material was again tested for thermal conductivity ratings.

The thermal conductivity ratings showed identical results for both the wet and dry materials.

UV Exposure

Owens Corning® Thermafiber® RainBarrier® insulation products are nondeteriorating and inorganic, making them UV-resistant. RainBarrier® Dark™ has been tested utilizing method ICC-ES AC38 Section 4.1.2 UV Exposure with ASTM D2244 Color Evaluation. Results are deemed an acceptable change in black color after UV exposure.

Mold Growth

Owens Corning® Thermafiber® RainBarrier® insulation products are inorganic and do not provide a food source to support mold growth. These products have been tested per ASTM Standard C1338, which is the test method for determining the resistance of insulation to the growth of fungi. The insulation material is sprayed with a fungal spore suspension, incubated in a warm, humid environment, and checked for fungal growth after 28 days of incubation. The test demonstrated that Owens Corning® Thermafiber® RainBarrier® insulation products supported no fungal growth.

Moisture Performance

Owens Corning® Thermafiber® RainBarrier® insulation products are vapor permeable and engineered not to absorb moisture. They have a minimal sorption of just 0.03%, even in harsh, hot, and humid environmental conditions, such as those measured by ASTM C1104 (120°F, 95% humidity for 96 hours¹). This indicates consistent thermal performance during the service conditions of the thermal insulation. Finally, the sorption property is consistent throughout the thickness of the mineral wool ci.

OTHER CONSIDERATIONS

Exposure

Wind Washing

Wind washing is wind-driven air movement through or behind thermal insulation within enclosures. Also, energy codes and standards in the United States do not require that wind washing be considered when specifying continuous insulation. The air flow over insulations can reach up to 3.2 ft./s (1.0 m/s) but most of the time ranges between 0.032 ft./s (0.01) to 0.32 ft./s (0.1 m/s).

Most fibrous exterior insulations have mid to high densities, and because of the small air velocities, the impacts on heat flow are relatively minor, ranging between 0 to 3%. Additionally, when temperatures decline, the R-value of mineral wool ci increases substantially due to a natural reduction in its thermal conductivity (due to reduction in radiation exchange within insulation materials). For example, as the mean temperature drops from 75°F to 15°F, the R-value of mineral wool increases approximately 30% (from R-4.3 to R-5.5).

Owens Corning does not recommend factoring in any degradation of R-value (due to wind) when specifying Thermafiber® RainBarrier® mineral wool continuous insulation products.

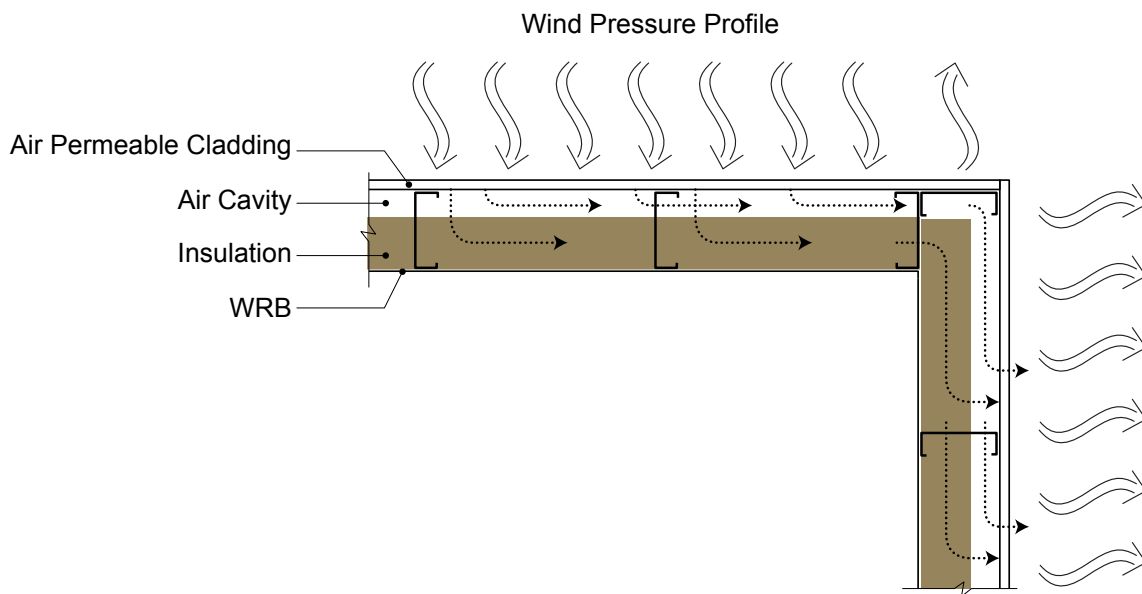

OTHER CONSIDERATIONS

Fire and Smoke Protection

Mineral Wool: Non-combustible Insulation

A non-combustible is defined as a material that, in the form in which it is used and under the conditions anticipated, will not ignite, burn, support combustion, or release flammable vapors when subjected to fire or heat. Materials that are reported as passing ASTM E136, Standard Test Method for Behavior of Materials in a Vertical Tube Furnace at 750°C¹⁵, shall be considered non-combustible materials. Mineral Wool products are non-combustible per ASTM E136. Mineral wool will resist flame propagation over the surface of the products. As a non-combustible material, mineral wool insulation is ideal for assemblies with combustible claddings and/or water-resistant barriers (WRB). When used with other combustible products, mineral wool acts as an aid in passing NFPA 285.

Standards and Testing

ASTM E136: Standard Test Method for Behavior of Materials in a Vertical Tube Furnace at 750°C

While it does not duplicate actual building fire exposure conditions, this test method assists in indicating those materials that do not act to aid combustion or add appreciable heat to an ambient fire.

NFPA 285¹⁶: Standard Fire Test Method for Evaluation of Fire Propagation Characteristics of Exterior Non-Load-Bearing Wall Assemblies Containing Combustible Components

NFPA 285 measures what happens during a fire when a non-combustible building is wrapped in combustible materials. NFPA 285 is required in the International Building Code (IBC) in multiple situations. Some examples may include when combustible air barriers are used or when foam plastic insulation is used in the exterior walls of construction types I, II, III, or IV. These construction types, by code definition, have exterior walls constructed of non-combustible materials. The NFPA 285 test is to determine that combustibles, when exposed to fire on the exterior face of the wall, do not spread flame over the surface or through the core of the otherwise non-combustible wall assembly.

The NFPA 285 standard test is referenced in many sections of the IBC, including Section 1404.5 for water-resistive barriers, and Section 2603.5.5 for foam plastic insulation. NFPA 285, or a variation of it, has been referenced in each edition of the IBC since its first edition in 2000, and since the 1980s in the three model codes that preceded it. The now defunct ICBO Uniform Building Code first included the concept in the 1988 edition, requiring testing in accordance with the UBC Standard 17-6, a predecessor of NFPA 285.

Blind Fastening

Blind fastening conditions are common in applications where the cladding and cladding attachment are fastened outboard of the mineral wool insulation. In these instances, the backup wall stud or other structure intended to receive the cladding attachment are not directly visible. While there are many instances of blind fastening, Owens Corning recommends some best practices to ensure plumb attachment penetration and to minimize accidental penetration of other building components. A common method is to identify the stud line using a laser line or mark the stud line to facilitate through fastener applications. If available, utilize a drill guide for long fasteners to help ensure accurate fastener penetration.

If the receiving stud is missed and there is concern about penetrating the continuity of the air barrier system, we recommend contacting the air barrier system manufacturer as repair methods vary.

¹⁵ ASTM International. ASTM E136-16a. Standard Test Method for Behavior of Materials in a Vertical Tube Furnace at 750°C. <https://www.astm.org>.

¹⁶ National Fire Protection Association. Standard Fire Test Method for Evaluation of Fire Propagation Characteristics of Exterior Non-Load-Bearing Wall Assemblies Containing Combustible Components. <http://www.nfpa.org>.

FURTHER INFORMATION

Product Literature

- **Thermafiber® RainBarrier® 45 Product Data Sheet**
Pub. No. 10021139
- **Thermafiber® RainBarrier® HD Product Data Sheet**
Pub. No. 10021140
- **Thermafiber® RainBarrier® Dark™ Product Data Sheet**
Pub. No. 10025102
- **Thermafiber® RainBarrier® ci High Compressive (80) Product Data Sheet**
Pub. No. 10023723
- **Thermafiber® RainBarrier® ci High Compressive Plus (110) Product Data Sheet**
Pub. No.10023499
- **Thermafiber® RainBarrier® ci High Compressive Max Product Data Sheet**
Pub. No. 10023500
- **Thermafiber® RainBarrier® Clip Product Data Sheet**
Pub No. 10021142
- **Thermafiber® Impasse® Hangers Product Data Sheet**
Pub No. 10021132
- **Thermafiber® RainBarrier® ci Moisture Performance Technical Bulletin**
Pub. No. 10024383
- **Thermafiber® RainBarrier® ci High Compressive Insulation Technical Bulletin**
Pub. No. 10023772

To learn more about Thermafiber® RainBarrier® Continuous Insulation Solutions, visit www.owenscorning.com/rainbarrier

Referenced Standards

- ANSI/ASHRAE/IES Standard 90.1, Energy Standard for Buildings Except Low-Rise Residential Buildings. American Society of Heating, Refrigerating, and Air-Conditioning Engineers. <https://www.ashrae.org>.
- AISI S100, North American Specification for Design of Cold-Formed Steel Structural Members, Washington, DC, www.steel.org.
- ASHRAE Standard 189.1, 2018 International Green Construction Code® Powered by Standard 189.1-2017, American Society of Heating, Refrigerating, and Air-Conditioning Engineers. <https://www.ashrae.org>.
- ASTM B117, Standard Practice for Operating Salt Spray (Fog) Apparatus, ASTM International, West Conshohocken, PA. www.astm.org.
- ASTM C356, Standard Test Method for Linear Shrinkage of Preformed High-Temperature Thermal Insulation Subjected to Soaking Heat, ASTM International, West Conshohocken, PA. www.astm.org.
- ASTM C518, Standard Test Method for Steady-State Thermal Transmission Properties by Means of the Heat Flow Meter Apparatus, ASTM International, West Conshohocken, PA. www.astm.org.
- ASTM C612, Standard Specification for Mineral Fiber Block and Board Thermal Insulation. ASTM International, West Conshohocken, PA. www.astm.org.
- ASTM C665, Standard Specification for Mineral-Fiber Blanket Thermal Insulation for Light Frame Construction and Manufactured Housing.
- ASTM International, West Conshohocken, PA. www.astm.org.
- ASTM C795, Standard Specification for Thermal Insulation for Use in Contact with Austenitic Stainless Steel, ASTM International, West Conshohocken, PA. www.astm.org.
- ASTM C1104, Standard Test Method for Determining the Water Vapor Sorption of Unfaced Mineral Fiber Insulation, ASTM International, West Conshohocken, PA. www.astm.org.
- ASTM C1338, Standard Test Method for Determining Fungi Resistance of Insulation Materials and Facings, ASTM International, West Conshohocken, PA. www.astm.org.
- ASTM E84, Standard Test Method for Surface Burning Characteristics of Building Materials, ASTM International, West Conshohocken, PA. www.astm.org.
- ASTM E96, Standard Test Methods for Water Vapor Transmission of Materials, ASTM International, West Conshohocken, PA. www.astm.org.
- ASTM E136, Standard Test Method for Behavior of Materials in a Vertical Tube Furnace at 750°C, ASTM International, West Conshohocken, PA. www.astm.org.
- ASTM E814, Standard Test Method for Fire Tests of Penetration Firestop Systems, ASTM International, West Conshohocken, PA. www.astm.org.
- ASTM E2273, Standard Test Method for Determining the Drainage Efficiency of Exterior Insulation and Finish Systems (EIFS) Clad Wall Assemblies, ASTM International, West Conshohocken, PA. www.astm.org.
- ASTM E2307, Standard Test Method for Determining Fire Resistance of Perimeter Fire Barriers Using Intermediate-Scale, Multistory Test Apparatus, ASTM International, West Conshohocken, PA. www.astm.org.
- CAN/ULC S102, Standard Method of Test for Surface Burning Characteristics of Building Materials and Assemblies, <https://canada.ul.com> CAN/ULC S114, Standard Method of Test for Determination of Non-Combustibility in Building Materials, <https://canada.ul.com> International Energy Conservation Code, International Code Council, <https://iccsafe.org>.
- NFPA285, National Fire Protection Association. Standard Fire Test Method for Evaluation of Fire Propagation Characteristics of Exterior Non-Load-Bearing Wall Assemblies Containing Combustible Components. <http://www.nfpa.org>.
- UL 2079, UL Standard for Safety Tests for Fire Resistance of Building Joint Systems, <https://standardscatalog.ul.com/>



Technical information contained herein is furnished without charge or obligation and is given and accepted at recipient's sole risk. Because conditions of use may vary and are beyond our control, Owens Corning makes no representation about, and is not responsible or liable for, the accuracy or reliability of data associated with particular uses of any product described herein. Owens Corning reserves the right to modify this document without prior notice.

THERMAFIBER, INC.
ONE OWENS CORNING PARKWAY
TOLEDO, OHIO 43659 USA
888-TFIBER1 [834-2371]
www.owenscorning.com/thermafiber

LEED® is a registered trademark of the U.S. Green Building Council.
Green Globes® is a registered trademark of Green Building Initiative, Inc.

Pub. No. 10021356-D. Printed in U.S.A. March 2022.
© 2022 Owens Corning. All Rights Reserved.