



Originally Issued: 06/02/2017

Revised: 05/24/2022

Valid Through: 06/30/2023

THE QUIKRETE COMPANIES, LLC
500 Marathon Parkway
Lawrenceville, GA 30046
770-216-9580
www.quikrete.com

QUIKRETE® Lightweight One Coat Fiberglass Reinforced Stucco (Lightweight FRS) QUIKRETE® One Coat Fiberglass Reinforced Stucco (One Coat FRS), QUIKRETE® One Coat FRS Concentrated, and QUIKRETE® Base Coat Stucco - Pump Grade

ADDITIONAL COMPANY NAMES:

- **MASTERWALL, INC.**
6975 Flat Rock Road
Midland, GA 31820
706-569-0092
- **STO CORP., INC.**
3800 Camp Creek Parkway, SW
Atlanta, GA 30331
404-821-5972

CSI Sections:

09 24 00 Cement Plastering

1.0 RECOGNITION

QUIKRETE® Lightweight One Coat Fiberglass Reinforced Stucco (Lightweight FRS), QUIKRETE® One Coat Fiberglass Reinforced Stucco (One Coat FRS), QUIKRETE® One Coat FRS Concentrated, and QUIKRETE® Base Coat Stucco - Pump Grade recognized in this report has been evaluated for use as an exterior wall covering in compliance with Chapters 14 and 25 of the IBC and Chapter 7 of the IRC. QUIKRETE® Lightweight FRS, One Coat FRS, One Coat FRS Concentrated, and Base Coat Stucco - Pump Grade have been evaluated for exterior durability, wind resistance, fire-resistance ratings, and installation on walls required to be of Types I, II, III, IV, or V construction, subject to the requirements in this report. QUIKRETE® Lightweight FRS, One Coat FRS, One Coat FRS Concentrated, and Base Coat Stucco - Pump Grade comply with the intent of the following codes and regulations:

- 2021, 2018, 2015, 2012, 2009 and 2006 International Building Code® (IBC)
- 2021, 2018, 2015, 2012, 2009 and 2006 International Residential Code® (IRC)
- 2019 California Building Code (CBC) – attached Supplement
- 2019 California Residential Code (CRC) – attached Supplement

- 2020 Florida Building Code, Building (FBC, Building) – attached Supplement
- 2020 Florida Building Code, Residential (FBC, Residential) – attached Supplement

2.0 LIMITATIONS

Use of the QUIKRETE® Lightweight FRS, One Coat FRS, One Coat FRS Concentrated, and Base Coat Stucco - Pump Grade recognized in this report is subject to the following limitations:

2.1 The QUIKRETE® Lightweight FRS, One Coat FRS, One Coat FRS Concentrated, and Base Coat Stucco - Pump Grade shall be installed in accordance with this report, the code (IBC or IRC), and The Quikrete Companies published installation instructions. Where conflicts occur, the more restrictive shall prevail.

2.2 All inspections required by the building official in accordance with IBC Section 110 or IRC Section R109, including lath inspection, shall be completed.

2.3 Buildings shall be provided with braced wall lines or shear walls in accordance with the IBC or IRC.

2.4 QUIKRETE® Lightweight FRS, One Coat FRS, One Coat FRS Concentrated, and Base Coat Stucco – Pump Grade shall be moist-cured in accordance with Sections 7.8 and 7.9 of ASTM C926 and the manufacturer’s installation instructions.

2.5 Where foam plastic insulation is used, a thermal barrier complying with IBC Section 2603.4 or IRC Section R316, as applicable, is required.

2.6 Where foam plastic insulation is used in areas where the probability of termite infestation is very heavy installations shall comply with 2021, 2018, 2015, 2009, and 2006 IBC Section 2603.8 (2012 IBC Section 2603.9) or 2021, 2018, 2015, 2012, and 2009 IRC Section R318.4 (2006 IRC Section R320.5), as applicable.

2.7 Under the 2021 IBC, the installation of water-resistive barriers shall comply with IBC Sections 2510.6.1 and 2510.6.2, as applicable. When compliance with Item No.2 of Section 2510.6.2 of the 2021 IBC is desired, a drainage test in accordance with ASTM E2273 or Annex A2 of ASTM E2925 shall be submitted to the building official for approval.

2.8 Where applied over wood-based sheathing, installation shall include a water-resistive barrier conforming with IBC Section 2510.6 or IRC Section R703.7.3, as applicable, and under the 2018 IBC where installed in Climate Zone 1A, 2A, or 3A, a ventilated air space shall be provided between the stucco and water-resistive barrier.

2.9 QUIKRETE® Lightweight FRS, One Coat FRS, One Coat FRS Concentrated, and Base Coat Stucco – Pump Grade recognized in this report are produced at the locations noted in Section 7.0 of this report.

The product described in this Uniform Evaluation Service (UES) Report has been evaluated as an alternative material, design or method of construction in order to satisfy and comply with the intent of the provision of the code, as noted in this report, and for at least equivalence to that prescribed in the code in quality, strength, effectiveness, fire resistance, durability and safety, as applicable, in accordance with IBC Section 104.11. This document shall only be reproduced in its entirety.





3.0 PRODUCT USE

QUIKRETE® Lightweight FRS, One Coat FRS, One Coat FRS Concentrated, and Base Coat Stucco–Pump Grade described in Section 1.0 of this report are recognized for use as exterior or interior wall coverings. QUIKRETE® One Coat FRS, One Coat FRS Concentrated, and Base Coat Stucco – Pump Grade may be used as standard ¾-inch (19.1 mm) thick first and second (scratch and brown) coats complying with ASTM C926 in accordance with Sections 2510.3 and 2512.1 of the IBC.

When applied in accordance with Section 3.3.2 of this report, the QUIKRETE® Lightweight FRS may be used in a one coat application at thicknesses ranging from 3/8 to 7/8 -inch (9.5 to 22.2 mm), and One Coat FRS, One Coat FRS Concentrated, and Base Coat Stucco – Pump Grade may be used in a one coat application at thicknesses ranging from 3/8 to 1/2 -inch (9.5 to 12.7 mm) as a component of one-hour fire-resistance-rated exterior wall assemblies.

When applied in accordance with Section 3.3.3 of this report, the QUIKRETE® One Coat FRS, One Coat FRS Concentrated, and Base Coat Stucco – Pump Grade may be applied on exterior walls of buildings of Type I, II, III, or IV construction of any height in accordance with IBC Section 2603.5.

3.1 Installation: Installation shall comply with this report. Additional requirements not mentioned herein shall comply with the IBC or IRC, ASTM C926, ASTM C1063, and the published instructions of The Quikrete Companies, as applicable. Where conflicts occur, the more restrictive shall govern. [Figures 2](#) through [5](#) of this report shall be referenced as needed.

3.1.1 Applicators: Installation shall be by a plastering contractor approved, by the Quikrete Companies, as being qualified to perform such installations. A list containing the names and addresses of approved contractors shall be maintained by the Quikrete Companies and shall be made available to the building official. An installation card with a format as shown in [Figure 6](#) of this report shall be completed by the plastering contractor and presented to the building official at the completion of each project.

3.2 Substrates: Substrates shall be load-bearing walls of concrete, masonry, or light-framing covered with gypsum board, fiberboard, wood structural wall sheathing, foam plastic insulations, or similar substrates. The light-framed wall shall be of minimum 0.42-specific-gravity (Spruce-Pine-Fir) wood studs or minimum No. 20-gauge [0.035 inch (0.889 mm)] steel studs spaced at 24 inches (610 mm) on center, maximum. The wall shall be prepared for the application of stucco in accordance with Section 3.2.3 of this report.

3.2.1 Foam Plastic Boards: Expanded, extruded, polyisocyanurate or mineral fiber foam plastic insulation boards may be used as components of wall substrates receiving QUIKRETE® Lightweight One Coat Fiberglass Reinforced Stucco (Lightweight FRS), QUIKRETE® One Coat Fiberglass Reinforced Stucco (One Coat FRS), QUIKRETE® One Coat FRS Concentrated, and QUIKRETE® Base Coat Stucco - Pump Grade. [Table 1](#) of this report specifies the minimum thickness for foam plastic insulation installed over sheathing or open studs. Where used, foam plastic insulation shall be installed over the exterior of the water-resistive barrier and the joints between the boards shall be lapped or oriented so that the water is diverted to the exterior. All foam plastic insulation shall have flame-spread and smoke-developed indices complying with Section 2603.5.4 of the IBC.

3.2.1.1 Expanded Polyurethane (EPS) Foam Plastic Insulation Board: EPS foam plastic insulation boards shall be Type II in accordance with ASTM C578, with a minimum nominal density of 1.5 pcf (24 kg/m³).

3.2.1.2 Extruded Polystyrene (XPS) Foam Plastic Insulation Board: XPS foam plastic insulation boards shall be Type IV or Type V in accordance with ASTM C578, with a minimum nominal density of 1.5 pcf (24 kg/m³).

3.2.1.3 Polyisocyanurate Foam Plastic Insulation Board: Polyisocyanurate foam plastic insulation boards shall be Type II in accordance with ASTM C1289, with a minimum nominal density of 2.0 pcf (32 kg/m³).

3.2.1.4 Mineral Fiber Insulation Board: Unfaced mineral fiber insulation boards, as described in Tables 5 and 6 of this report, shall be Type IVA or IVB in accordance with ASTM C612, at any thickness or density that is non-combustible and complying with ASTM E136. Verification of compliance is beyond the scope of this report and is determined by a separate evaluation report, or as otherwise approved by the building official.

3.2.1.5 Fastening: Foam plastic insulation shall be in accordance with Section 3.2.1 of this report. The EPS or XPS foam plastic boards are placed horizontally over the water-resistive barrier beginning at the wall base with tongued edges facing up. Vertical edges shall be over stud framing and staggered to fall one or more studs away as layers progress upwards. Where the foam boards are attached to wood framing using No. 11 gauge by 2-inch (50.8 mm) long roofing nails at 8 inches (203 mm) on center complying with ASTM F1667. The fasteners shall penetrate no less than 1 inch (25.4 mm) into the wood framing. Where the foam boards are attached to steel framing using No.8 by 1⁵/₈ -inch (41.3 mm) long wafer head screws with 1-inch (25.4 mm) diameter plastic washer. Fastener spacing shall be a maximum 6 inches (152 mm) on center.



TABLE 1 – Foam Plastic Boards

Backing	Configuration
Open framing	1.0 to 1.5-inch thick foam plastic boards with 3/8-inch high tongue and groove horizontal joints as shown in Figure 1 of this report
Wood structural panel (WSP) sheathing	Minimum 0.5-inch thick
WSP sheathing where foam plastic forms part of the water-resistive barrier	Minimum 1.0-inch-thick foam plastic insulation with 3/8-inch high tongue and groove horizontal joints as shown in Figure 1 of this report with the tongue facing upward
Solid sheathing	Minimum 0.5-inch-thick, 1.0 pcf density EPS insulation, with vertical drainage grooves ¹ on the back face of the EPS board

SI conversions: 1 inch=25.4 mm; 1 foot = 305 mm; 1 pcf = 16 kg/m³

¹ Grooves are 1/4" wide x 1/8" deep, spaced 12" on center. As an alternative to the vertical drainage grooves, the EPS may be installed over Tyvek® Stuccowrap® or Tyvek® DrainWrap™ water-resistive barrier.

3.2.2 Rigid Backing: Rigid backings include gypsum board, fiberboard, and wood structural panel sheathing. The water-resistive barrier shall be installed on the exterior of rigid backings.

3.2.2.1 Gypsum Board: Gypsum Boards shall be a minimum 1/2-inch-thick (12.7 mm) and shall comply with Section 2506 of the IBC or Sections R602.3 and R702 of the IRC, as applicable. The boards shall be protected from the weather in accordance with IBC Section 2508.2 and ASTM C1280. Permitted types include water-resistant gypsum backing board and gypsum sheathing board complying with ASTM C1396; and glass mat gypsum substrate complying with ASTM C1177. Gypsum wallboard complying with ASTM C1396 is permitted on the interior side of walls where specified in this report. Verification of compliance is beyond the scope of this report.

3.2.2.2 Cellulosic Fiber Insulating Board (Fiberboard): Fiberboard shall comply with Section 2303.1.6 of the 2021, 2018, and 2015 IBC (Section 2303.1.5 of the 2012, 2009, and 2006 IBC) and shall be Type IV, Grade 1, or Grade 2 wall sheathing as set forth in ASTM C208, minimum 1/2-inch-thick (12.7 mm). Verification of compliance is beyond the scope of this report.

3.2.2.3 Wood Structural Panel Sheathing: Wood structural panel (WSP) sheathing shall comply with Section 2303.1.5 of the 2021, 2018, and 2015 IBC (Sections 2303.1.4 of the 2012, 2009, and 2006 IBC), Section 2304.6.1, and Table 2304.6.1 of the IBC or Section R602.3 and Table R602.3 (3) of the IRC, as applicable. Wood Structural Panel Sheathing includes exterior grade Plywood complying with DOC PS-1 and Oriented strand board (OSB) Exposure 1 complying with DOC PS-2.

3.2.2.4 Concrete or Masonry Substrates: Direct application of QUIKRETE® One Coat Fiberglass Reinforced

Stucco (One Coat FRS), One Coat FRS Concentrated, and Base Coat Stucco – Pump Grade to concrete and masonry walls is permitted in accordance with ASTM C926 (IBC), or IRC Section R703.6. No water-repellent coatings such as bituminous coatings or other foreign matter shall be present on the substrate. The substrate shall be sufficiently moist to prevent it from drawing the water needed for hydration from the stucco paste. Where required to remove foreign matter, surfaces shall be cleaned using acid solutions, solvents, or detergents and then washed with clean water. Smooth surfaces shall be roughened, and an approved bonding agent applied to block, concrete, or masonry surfaces, as appropriate.

3.2.3 Substrate Preparation: The substrates shall be prepared for the application of stucco in accordance with this section (Section 3.2.3) of this report.

3.2.3.1 Weep Screed: Weep screeds shall be installed at the base of the assembly. Weep Screeds shall comply with Section 2512.1.2 of the IBC or Section R703.7.2.1 of the 2021, 2018, and 2015 IRC (Section R703.6.2.1 of the 2012, 2009, and 2006 IRC), and ASTM C1063.

3.2.3.2 Water-resistive Barrier: Water-resistive barriers (WRB) shall comply with IBC Sections 1404.2 and 2510.6, IRC Section R703.2, or the WRB evaluation report, as applicable, to prevent water from entering the substrate. For installation of WRB's under the 2021 IBC, refer to Section 2.7 of this report.

3.2.3.2.1 Wood-based Sheathing: For installations over wood-based sheathing (fiberboard or WSP sheathing), the water-resistive barrier shall be in accordance with Section 2510.6 of the IBC or Section R703.6.3 of the IRC, as applicable. The barrier shall be a minimum of two layers of Grade D Kraft paper, or one layer of polystyrene (EPS or XPS) foam plastic insulation board described in Sections 3.2.1.1 and 3.2.1.2 of this report, applied over one layer of 60-minute Grade D building paper may be used as a WRB. For installations without wood-based sheathing, the water-resistive barrier shall be a minimum of one layer.

3.2.3.2.2 Types I through IV Construction: In Types I through IV construction of buildings of any height in accordance with [Tables 5](#) and [6](#) of this report, Tremco ExoAir 230 or another water-resistive barrier that is shown by ASTM E1354 testing (at 50 kW/m² min. heat flux) and analysis to be equivalent in flammability shall be used.

In prescriptive assemblies of Types I through IV construction, any WRB meeting the maximum combustion in ASTM E1354 and ASTM E84, as described in IBC Section 1402.5, Exception No.2, may be used provided the WRB is the assembly's only combustible component. When compliance with Item No.2.2 in Section 1402.5 of the 2021 IBC is desired, the flame-spread and smoke-developed indices in accordance with ASTM E84 shall be tested with



the test specimen and mounting in accordance with ASTM E2404.

3.2.3.3 Keene Building Products Rainscreens: Keene Driwall Rainscreens, DWRS 10mm or DWRS 020, with Keene Easy-Fur, may be used in assemblies with The QUIKRETE® One Coat FRS, One Coat FRS Concentrated, and Base Coat Stucco – Pump Grade. The Keene Driwall Rainscreens may be installed in Construction Types I, II, III, and IV over approved water-resistive barriers and shall be installed horizontally and against the exterior wall with fabric side out, and mechanically fastened as noted in Section 3.2.1.5 of this report.

3.2.3.4 Casing Beads and Corner Beads: Casing and corner beads shall be installed to provide a finish at the boundaries of the assemblies in accordance with ASTM C1063. Areas of backings not covered by plaster shall be covered with galvanized steel casing beads.

3.2.3.5 Flashing: Flashing shall be installed to properly divert water in accordance with the manufacturer's instructions and the applicable code. Flashing shall comply with Section 1404.4 of the 2021 and 2018 IBC; Section 1405.4 of the 2015, 2012, and 2009 IBC (Section 1405.3 of the 2006 IBC); Section R703.4 of the 2021, 2018 and 2015 IRC and Section R703.8 of the 2012, 2009 and 2006 IRC, as applicable. Membrane flashing shall be self-adhering flexible rubberized asphalt and polyethylene, minimum 0.030 inch (0.76 mm) thick.

3.2.3.6 Lath: Lath shall be regular or self-furring wire fabric lath or metal lath complying with the code and ICC-ES AC191, as applicable. Verification of compliance with AC191 is beyond the scope of this report and the lath shall be recognized in a current evaluation report, or as otherwise determined by the building official. The lath shall be corrosion-resistant, furred or self-furring type. Wire fabric lath shall be minimum No. 20 gauge [0.035 inch (0.89 mm)], 1-inch (25.4 mm), galvanized steel, woven-wire fabric. The lath shall be installed in accordance with IBC Section 2510 through 2512 or IRC Section R703, and ASTM C1063, as applicable. Lath Fasteners shall penetrate through foam plastic insulation and sheathing into the framing. The furring distance of self-furring lath shall comply with IBC Section 2510.3, or 2021, 2018 and 2015 IRC Section R703.7 and 2012, 2009 and 2006 IRC Section R703.6, as applicable, or with the following requirements:

- Furred No. 20 gauge [0.035 inch (0.89 mm)] lath shall be used with the QUIKRETE® Lightweight FRS, One Coat FRS, One Coat FRS Concentrated and Base Coat Stucco – Pump Grade product up to ½-inch (12.7 mm) thick including finish coats. For coating thicknesses, greater than ½-inch (12.7 mm), furred No. 17 gauge [0.056 inch (1.42 mm)] wire fabric lath shall be used.
- Furring crimps shall be provided at a maximum 6-inch (152 mm) intervals each way. Furring crimps shall fur

the body of the lath a minimum of 1/8-inch (3.18 mm) from the substrate after installation.

- Unfurred lath is permitted over unbacked polystyrene boards in accordance with AC11.

3.2.4 Plaster Mixing: The QUIKRETE® Lightweight FRS, One Coat FRS, and Base Coat Stucco – Pump Grade shall be ready to use with suitable clean potable water in accordance with Section 4.0 of this report and the manufacturer's installation instructions.

3.2.4.1 The QUIKRETE® One Coat FRS Concentrated shall be mixed with suitable sand and clean, potable water in accordance with Section 4.0 of this report and the manufacturer's installation instructions.

3.2.5 Plastering: The QUIKRETE® Lightweight FRS, One Coat FRS, One Coat FRS Concentrated, and Base Coat Stucco – Pump Grade base coat shall be 3/8 to 1/2 inch (9.5 to 12.7 mm) thick without cold joints. Finish coats may be applied in accordance with the finish coat application instructions after the base coat fully cures. The permitted air temperatures during application are 40°F to 100°F (4.4°C to 38°C). The brown coat shall be hard floated to promote densification and cut through full depth with a trowel at the intersection of plastered walls and plastered soffits

3.2.6 Miscellaneous:

3.2.6.1 Control or Expansion joints: Control or expansion joints shall be as specified by the designer, builder, or stucco manufacturer, in that order. In addition, joints shall be provided in accordance with The Quikrete Companies' installation instructions and when required by ASTM C1063.

3.2.6.2 Caulking: Joints formed where the boards abut dissimilar materials such as at windows, doors, and other penetrations shall be filled with caulking. Caulking shall be acrylic latex complying with ASTM C834 or polysulfide, polyurethane, polyurethane modified, or silyl-terminated polyether elastomeric sealant complying with ASTM C920.

3.2.6.3 Vapor Retarder: Vapor retarders shall comply with Section 1404.3 of the 2021, 2018, 2015, 2012, and 2009 IBC (Section 1403.2 of the 2006 IBC) or Section R702.7 of the 2021, 2018, 2015, and 2012 IRC (Sections R601.3 and R318.1 of the 2009 and 2006 IRC, respectively), as applicable.

3.2.6.4 Soffits: Installation to soffits shall comply with ASTM C1063 as for ceilings, except wire fabric lath is not permitted. Fasteners shall penetrate into the framing.

3.2.6.5 Sills: Installation to sills at windows or pop-outs may be done for walls where the sill is up to 6 inches (152 mm) wide. Wider sills require lumber or WSPS fastened to framing as set forth in Section 2304.10.2 of the 2021 IBC, Section 2304.10.1 of the 2018 and 2015 IBC (IBC Section



2304.9.1 of the 2012, 2009, and 2006) or IRC Section R602.3.

3.2.6.6 Product Storage: The bags shall be kept indoors or, if stored outdoors, shall be stored off the ground and adequately covered to keep the product dry.

3.2 Design

3.3.1 Wind Load: The maximum allowable wind loads on the QUIKRETE® Lightweight FRS, One Coat FRS, One Coat FRS Concentrated, and Base Coat Stucco–Pump Grade are set forth in [Tables 3](#) and [3A](#) of this report. The backing and fastening of the backing, including the lath to the framing shall comply with [Tables 3](#) and [3A](#) and installation shall comply with the applicable code and this report.

3.3.2 One-hour Fire-resistance-rated Construction: The one-hour fire-resistance-rated (FRR) assemblies incorporating The QUIKRETE® Lightweight FRS, One Coat FRS, One Coat FRS Concentrated, and Base Coat Stucco – Pump Grade are described in [Table 4](#) of this report. The assemblies in Table 4 of this report shall comply with IBC Section 703.2.

Recognition of The QUIKRETE® Lightweight FRS, One Coat FRS, One Coat FRS Concentrated, and Base Coat Stucco – Pump Grade in two-hour fire-resistance-rated construction is out of the scope of this report. Approval of 2-hour FRR assemblies shall be in accordance with 2021 IBC Section 703.2.2 and 2018, 2015, 2012, 2009, and 2006 IBC Section 703.3.

3.3.3 Exterior Walls on Buildings of Type I, II, III or IV Construction

3.3.3.1 General: Exterior wall assemblies incorporating QUIKRETE® One Coat FRS, One Coat FRS Concentrated, and Base Coat Stucco – Pump Grade and constructed entirely of noncombustible components or concrete/masonry walls with directly applied stucco in accordance with Section 3.2.2.4 of this report, are permitted to be used in Types I through IV construction on buildings of any height allowed in IBC Section 504. These assemblies may include a water-resistive barrier as its only combustible component, provided the WRB does not exceed the maximum combustion, heat release, and surface burning criteria contained in ASTM E1354 and ASTM E84 as described in Sections 1402.5 and 2603.5 of the 2021, 2018, 2015, and 2012 IBC. Use of these WRBs shall be approved by the building official based on reports of WRB testing in accordance with ASTM E1354 and ASTM E84. When compliance with Item No.2.2 in Section 1402.5 of the 2021 IBC is desired, the flame-spread and smoke-developed indices in accordance with ASTM E84 shall be tested with the test specimen and mounting in accordance with ASTM E2404.

3.3.3.2 Assemblies based on NFPA 285 testing: [Tables 5](#) and [6](#) of this report detail exterior wall assemblies containing non-combustible components and combustible alternatives recognized for use on buildings of Types I through IV construction of any height based on NFPA 285 testing and analysis. The use of components other than the allowable alternatives described in the tables is outside the scope of this report.

4.0 PRODUCT DESCRIPTION

4.1 General: QUIKRETE® Lightweight FRS, One Coat FRS, One Coat FRS Concentrated, and Base Coat Stucco – Pump Grade consist of cement plaster, metal or wire fabric lath, water-resistive barrier, foam plastic insulation, and rigid backings of either gypsum board, fiberboard, wood structural panel sheathing, concrete or masonry.

4.2 QUIKRETE® LIGHTWEIGHT FRS, ONE COAT FRS, ONE COAT FRS CONCENTRATED and BASE COAT STUCCO – PUMP GRADE COMPONENTS

4.2.1 QUIKRETE® Lightweight Fiberglass Reinforced Stucco (Lightweight FRS): Lightweight FRS is a factory prepared, dry-blended, fiber-reinforced, modified Portland cement-based plaster. The stucco complies with ASTM C150, ASTM C595, or ASTM C91. Each bag is blended with recycled Expanded Polystyrene (EPS) packaged in 50-lb and 1,875-lb (22.6 kg and 850 kg). Each 50-lb bag of Lightweight FRS is mixed with 1-¼ to 1-¾ gallons (4.7 L to 6.6 L) of water.

4.2.2 QUIKRETE® One Coat Fiberglass Reinforced Stucco (One Coat FRS): One Coat FRS is a factory prepared, sanded, fiber-reinforced, modified Portland cement-based plaster. The stucco complies with ASTM C150, ASTM C595, or ASTM C91. Each bag is packaged in 80-lb and 3,000-lb (36.2 kg and 1360.7 kg). Each 80-lb bag of QUIKRETE® One Coat FRS is mixed with 1-¼ to 1-¾ gallons (4.7 L to 6.6 L) of water for mixture in the field.

4.2.3 QUIKRETE® One Coat Fiberglass Reinforced Stucco Concentrated (One Coat FRS): The QUIKRETE® One Coat FRS Concentrated mixture is similar to the QUIKRETE® One Coat Fiberglass Reinforced Stucco described in Section 4.2.2 of this report, except that each 80-lb (36.2 kg) bag is mixed with 210 to 250 lbs (95.2 to 113 kg) of plaster sand complying with Section 4.2.5 of this report and 5 gallons (19 L) of water for mixture in the field.

4.2.4 QUIKRETE® Base Coat Stucco - Pump Grade: The QUIKRETE® Base Coat Stucco - Pump Grade mixture is identical to the QUIKRETE® One Coat Fiberglass Reinforced Stucco described in Section 4.2.2 of this report, except for the name.

4.2.5 Sand: The plaster sand shall be clean and free of deleterious amounts of loam, clay, silt, soluble salts, and



organic in accordance with ASTM C144 or ASTM C897, as applicable. Sampling and testing shall comply with ASTM C144 or C897, as applicable. Aggregate shall be graded in accordance with ASTM C144, ASTM C897, or as shown in [Table 2](#) of this report.

TABLE 2 – Sand Gradation

U.S. Standard Sieve	Weight Percent of Aggregate Retained ± 2 Percent	
	Min.	Max.
No. 4	–	0
No. 8	0	10
No. 16	10	40
No. 30	30	65
No. 50	70	90
No. 100	95	100

The concentrate, sand, and water shall be mixed for a minimum of five minutes.

5.0 IDENTIFICATION

Product packaging shall include the company name or trademark, product name or model number, The IAPMO Uniform ES Mark of Conformity, the name of the inspection agency (when applicable), and the Evaluation Report Number (ER-455) to identify the products recognized in this report. Either Mark of Conformity may be used as shown below:

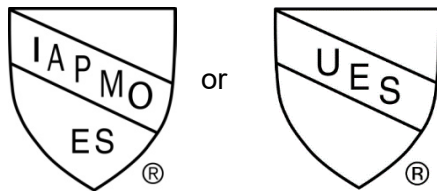

IAPMO UES ER-455

6.0 SUBSTANTIATING DATA

6.1 Data in accordance with the ICC-ES Acceptance Criteria for Cementitious Exterior Wall Coatings (AC11), dated January 2013 (editorially revised October 2020).

6.2 Manufacturer’s quality documentation, descriptive literature, and installation instructions.

6.3 Reports of testing in accordance with ASTM E72, E136 (only applicable to the QUIKRETE® One Coat FRS, One Coat FRS Concentrated, and Base Coat Stucco – Pump Grade) G155, C926, C1063, C840, C1396, C1177, C834, and C920.

6.4 Reports of testing and analysis in accordance with NFPA 285 - (only applicable to the QUIKRETE® One Coat FRS, One Coat FRS Concentrated, and Base Coat Stucco – Pump Grade).

6.5 Reports of fire-resistance testing in accordance with ASTM E119.

6.6 Test reports are from laboratories in compliance with ISO/IEC 17025.

7.0 STATEMENT OF RECOGNITION

This evaluation report describes the results of research completed by IAPMO Uniform Evaluation Service on QUIKRETE® Lightweight Fiberglass Reinforced Stucco, QUIKRETE® One Coat Fiberglass Reinforced Stucco (FRS), QUIKRETE® One Coat FRS Concentrated, and QUIKRETE® Base Coat Stucco - Pump Grade are manufactured in Alvarado, Texas; Buckeye, Arizona; Denver, Colorado; Lithonia, Georgia; Perryville, Maryland; Ravenna, Ohio; Sacramento, California; Salt Lake City, Utah; Stormville, New York; Wauregan, Connecticut; New Orleans, Louisiana; Tacoma, Washington; Jacksonville, Florida; Lakeland, Florida; Peachland, North Carolina; City of Industry, California; Kansas City, Kansas; and Valley Park, Missouri to assess its conformance to the codes and standards shown in Section 1.0 of this report and documents the product’s certification. Use of the QUIKRETE® Lightweight FRS, One Coat FRS, One Coat FRS Concentrated, and Base Coat Stucco - Pump Grade manufactured for use in the state of Florida, at the Jacksonville and Lakeland, Florida facilities are limited to be used only in Florida.

For additional information about this evaluation report please visit www.uniform-es.org or email us at info@uniform-es.org



TABLE 3 – Allowable Wind Loads – Lightweight FRS

Wall Type	Minimum specification	Backing	Maximum Framing spacing (inch) ¹	Allowable Positive Load (psf)	Allowable Negative Load (psf)
Wood-frame ^{2,3}	SG = 0.42 (Spruce-Pine-Fir)	Foam Plastic	24	81	43
		Rigid Backing ⁶		67	66
Steel ^{4,5}	No. 20 gauge (0.0359 inch)	Foam Plastic	24	57	38
		Rigid Backing ⁶		60	43

¹ Supporting wall shall have a maximum deflection of 1/240 of the span and be designed to support the design load.

² The pre-furred lath shall be fastened to the wood framing using No. 11 by 2-inch long roofing nails spaced at 6 inches on center and shall penetrate a minimum of 1-inch into the wood framing.

³ The foam plastic boards are attached to wood framing using No. 11 gauge by 2-inch (50.8 mm) long roofing nails at 8 inches (203 mm) on center complying with ASTM F1667 and penetrate no less than 1 inch (25.4 mm).

⁴ The pre-furred lath shall be fastened to the steel framing using No.8 by 1⁵/₈-inch long self-drilling screws spaced at 6 inches on center.

⁵ The foam plastic boards are attached to steel framing using No. 8 by 1⁵/₈-inch (41.3 mm) long wafer head screws with 1-inch (25.4 mm) diameter plastic washers. Fastener spacing is 6 inches (152 mm) or less.

⁶ Rigid backing includes gypsum board, fiberboard, and wood structural panel sheathing.

TABLE 3A – Allowable Wind Loads – One Coat FRS

Wall Type	Minimum specification	Backing	Maximum Framing spacing (inch) ¹	Allowable Positive Load (psf)	Allowable Negative Load (psf)
Wood-frame ²	SG = 0.55 (Southern Pine)	Rigid Backing ⁵	24	29	28
Steel ^{3,4}	No. 16 gauge (0.057 inch)	Foam Plastic	24	55	37
		Rigid Backing ⁵		55	42
Concrete and Concrete Masonry	-	Direct	-	Limited by wall capacity	

¹ Supporting wall shall have a maximum deflection of 1/240 of the span and be designed to support the design load.

² The woven-wire lath shall be fastened to the wood framing using No.8 by 1⁵/₈-inch roofing nails spaced at 6 inches on center and shall penetrate a minimum of 1-inch into the wood framing.

³ The woven-wire lath shall be fastened to the steel framing using No.8, Type S-12, self-drilling screws with 0.420-inch diameter pancake heads. Fastener spacing is 6 inches (152 mm) or less.

⁴ The foam plastic boards are attached to steel framing using No. 8, Type S-12, self-drilling screws with 0.420-inch diameter pancake heads. Fastener spacing is 6 inches (152 mm) or less.

⁵ Rigid backing includes gypsum board, fiberboard, and wood structural panel sheathing.



TABLE 4—One-hour Fire-Resistance-Rated Wall Assemblies

Item	Material	Construction	ASD Axial Loading
1	Lightweight FRS, One Coat FRS, One Coat FRS Concentrated, and Base Coat Stucco – Pump Grade	2x4 or 2x6 wood studs spaced a maximum of 24-inches on center. The interior face has one layer of 5/8-inch thick Type X gypsum wallboard applied parallel or at right angles with all joints backed by framing and attached with 6d x 1 7/8 -inch cupped-head drywall nails having 1/4 inch diameter heads at 7 inches on-center to studs, plates, and blocking. Fastener heads and joints of the wallboard shall be taped and treated with joint compound in accordance with IBC Section 2508.4, and either ASTM C840 or GA-216. As an option, 3- 1/2 inch thick, R-11 glass fiber insulation or mineral wool batts or blankets complying with Section 720 of the 2021, 2018, 2015, and 2012 IBC (Section 719 of the 2009 and 2006 IBC) or Section R302.10 of the 2021, 2018, 2015, 2012 and 2009 IRC (Section R316 of the 2006 IRC) may be installed between the studs. The outside face has one layer of 5/8 -inch thick Type X gypsum sheathing board shall be applied vertically with all joints backed by framing and attached to wood studs using No. 11 gauge by 1-3/4-inch long galvanized roofing nails having 7/16 -inch diameter heads spaced 4 inches on-center at edges and 7-inches on-center at intermediate studs and top and bottom plates. The water-resistive barrier, lath, and stucco shall be applied as described in the applicable sections of this report and the manufacturer’s published installation instructions. Wood structural panel sheathing between the face of the wood studs and the exterior gypsum wallboard is allowed, with the length of the fasteners used to attach the gypsum wallboard long enough to cover the additional thickness of the wood sheathing. As an option, a 1-inch thick, Type II EPS or XPS, 1.5 pcf or 2 pcf polyisocyanurate foam plastic insulation installed over the WRB recognized in a current research report and exterior sheathing is allowed. The lath shall be fastened through the foam insulation board to studs and plates at 6 inches on-center as described by the applicable research report. The fasteners used to attach the lath shall penetrate a minimum of 1-inch into wood framing using No. 11 gauge roofing nails or galvanized staples having a minimum crown width of 7/16-inch in diameter.	<p>Lesser of:</p> <ol style="list-style-type: none"> 1. 3,000 pounds (13,345 N) per stud for 2 x 6 construction; 2. A maximum of 78 percent of the load calculated in accordance with Sections 3.6 and 3.7 of the ANSI/AWC NDS; 3. “For studs with a slenderness ratio, le/d, greater than 33, the design stress shall be reduced to 78 percent of allowable F'_c (IBC)” <p>or</p> <ol style="list-style-type: none"> 4. “For studs with a slenderness ratio, le/d, not exceeding 33, the design stress shall be reduced to 78 percent of the adjusted stress F'_c calculated for studs having a slenderness ratio le/d of 33 (IBC)”
2	Lightweight FRS, One Coat FRS, One Coat FRS Concentrated, and Base Coat Stucco – Pump Grade	2x4 or 2x6 wood studs spaced a maximum 24 inches on-center. The interior face has one layer of 5/8 -inch thick Type X gypsum wallboard applied parallel or at right angles by framing and attached with 6d x 1- 7/8 -inch cupped-head drywall nails having 1/4 inch diameter heads at 7 inches on-center to studs, plates, and blocking. Nailheads and wallboard joints shall be taped and treated with joint compound in accordance with IBC Section 2508.4 and either ASTM C840 or GA-216. As an option, 3 1/2 inch thick, R-11 glass fiber insulation or	<p>Lesser of:</p> <ol style="list-style-type: none"> 1. 3,000 pounds (13,345 N) per stud for 2 x 6 construction 2. A maximum of 51.3 percent of the load, calculated in accordance with Sections 3.6 and 3.7 of the ANSI/AWC NDS;



EVALUATION REPORT

Number: 455

Originally Issued: 06/02/2017

Revised: 05/24/2022

Valid Through: 06/30/2023

<p>2(Continued)</p>	<p>Lightweight FRS, One Coat FRS, One Coat FRS Concentrated, and Base Coat Stucco – Pump Grade</p>	<p>mineral wool batts or blankets complying with Section 720 of the 2021, 2018, 2015, and 2012 IBC (Section 719 of the 2009 and 2006 IBC) or Section R302.10 of the 2021, 2018, 2015, 2012, and 2009 IRC (Section R316 of the 2006 IRC) may be installed between the studs. The outside face of the studs shall be covered with one layer of 7/16-inch wood structural panel sheathing, where the WRB recognized in a current research report is installed over the sheathing or 1/2-inch thick gypsum sheathing attached in accordance with the applicable sections of this report. The lath and stucco shall be applied with or without the foam plastic insulation in accordance with the manufacturer's published installation instructions. As an option, a 1-inch thick, Type II EPS or XPS, 1.5 pcf or 2 pcf polyisocyanurate foam plastic insulation recognized in a current research report may be installed over the exterior sheathing. The lath shall be fastened through the foam insulation board to studs and plates at 6 inches on-center as described in the manufacturer's published installation instructions and shall be fastened with No.11 roofing nails or galvanized staples having a minimum crown width of 7/16 inch, penetrating a minimum of 1-inch into the wood framing.</p>	<p>3. "For studs with a slenderness ratio, le/d, greater than 33, the design stress shall be reduced to 78 percent of allowable F'_c (IBC)"</p> <p>or</p> <p>4. "For studs with a slenderness ratio, le/d, not exceeding 33, the design stress shall be reduced to 78 percent of the adjusted stress F'_c calculated for studs having a slenderness ratio le/d of 33 (IBC)"</p>
<p>3</p>	<p>Lightweight FRS, One Coat FRS, One Coat FRS Concentrated, and Base Coat Stucco – Pump Grade</p>	<p>2x4 or 2x6 wood studs spaced a maximum 24-inches on center. The interior face has one layer of 5/8-inch thick Type X gypsum wallboard applied parallel or at right angles with all joints backed by framing and attached with 6d x 1-5/8-inch, cupped-head drywall nails having 1/4 in diameter heads at 7 inches on-center to studs, plates and blocking. Nailheads and wallboard joints shall be taped and treated with joint compound in accordance with IBC Section 2508.4 and either ASTM C840 or GA-216. As an option, 3-1/2 inch thick, R-11 glass fiber insulation or mineral wool batts or blankets complying with Section 720 of the 2021, 2018, 2015, and 2012 IBC (Section 719 of the 2009 and 2006 IBC) or Section R302.10 of the 2021, 2018, 2015, 2012 and 2009 IRC (Section R316 of the 2006 IRC) maybe be placed between the studs. The outside face has foam plastic insulation board that is applied over the WRB to open studs and fastened in place. The lath and stucco shall be installed in accordance with the manufacturer's published installation instructions. The foam plastic insulation may be either a 1-inch thick, 1.5 pcf foam plastic insulation including EPS, XPS, or a 2 pcf polyisocyanurate rigid foam sheathings, both recognized in a current research report. The lath shall be fastened through the foam insulation board to studs and plates at 6 inches on-center as described in the manufacturer's published installation instructions and shall be fastened with No.11 roofing nails or galvanized staples having a minimum crown width of 7/16 inch, penetrating a minimum of 1-inch into the wood framing.</p>	<p>Lesser of:</p> <p>1. 3,000 pounds (13,345 N) per stud for 2 x 6 construction;</p> <p>2. A maximum of 51.3 percent of the load calculated in accordance with Sections 3.6 and 3.7 of the ANSI/AWC NDS;</p> <p>3. "For studs with a slenderness ratio, le/d, greater than 33, the design stress shall be reduced to 78 percent of allowable F'_c (IBC)"</p> <p>or</p> <p>4. "For studs with a slenderness ratio, le/d, not exceeding 33, the design stress shall be reduced to 78 percent of the adjusted stress F'_c calculated for studs having a slenderness ratio le/d of 33 (IBC)"</p>



TABLE 5 – NFPA 285 WALL ASSEMBLY WITH FOAM INSULATION

Framing	No.20-gauge [0.035 inch (0.889 mm)] (min.) by 3 5/8-inch-wide (92 mm) or deeper, non-load-bearing steel studs shall be spaced at maximum 24 inches (610 mm) on center. The steel thickness shall be adequate for the fasteners and accessories used. Wall openings shall be framed with a minimum 0.125-inch-thick (3.18 mm) steel or tubular aluminum. Alternative Framing: 2x4 or deeper non-bearing Fire-Retardant-Treated Wood (FRTW) studs spaced at 16 inches on center (406 mm) (min.) or 24 inches on center (609 mm) (max.) meeting the requirements of IBC Section 2303.2 may be used instead of steel studs where fire-resistance-rated construction is not required in accordance with IBC Section 603.
Interior Panel	One layer of 5/8-inch-thick (15.9 mm) (min.) Type X gypsum wallboard shall be applied vertically on the interior side and attached with No.8 by 1¼-inch-long (31.8 mm) bugle-head screws spaced at 8 inches (203 mm) on center at board joints and 12 inches (305 mm) on center in the field. Gypsum wallboard fasteners and joints shall be taped and treated as set forth in Section 2508.4 of the IBC and either ASTM C840 or GA-216.
Optional Cavity Insulation	Any non-combustible insulation including non-combustible mineral fiber or fiberglass, faced or unfaced, may be used in the framing cavities. <i>No cavity insulation is an acceptable alternative.</i>
Optional Vapor Retarder	A thin plastic Class I or foil vapor retarder may be used.
Fireblocking¹	Fireblocking consisting of 1 ½" FRT lumber or 4 pcf (64 kg/m ³) density (min.) mineral fiber insulation shall be installed to block the wall stud spaces at the ceiling and floor levels in accordance with Section 718.2 of the IBC. The fiber insulation shall be nominally 4 inches (102 mm) thick (min.), and friction fit or clipped within the stud space.
Exterior Sheathing	The exterior side shall have one layer of ½ -inch-thick (12.7 mm) (min.) gypsum sheathing applied horizontally and attached with No.8 by 1¼-inch-long (31.8 mm) bugle-head screws spaced at 8 inches (203 mm) on center along all framing. Alternative Sheathing: Fire-Retardant-Treated plywood sheathing, ½-inch-thick (12.7 mm) (min.), meeting the requirements of IBC Section 2303.2 may be used instead of gypsum sheathing. Use of FRTW sheathing shall comply with IBC Section 603.
WRB	Tremco ExoAir 230 or another water-resistive barrier that is shown by ASTM E1354 testing (at 50 kW/m ² min. heat flux) and analysis to be equivalent in flammability. The following WRBs were tested and shown to be equivalent: Dupont Tyvek (CommercialWrap, CommercialWrap D), Dupont (Fluid Applied WB and WB-SP), Fortifiber WeatherSmart (Housewrap, Drainable, Commercial), Fortifiber Super Jumbo Tex 60 Minute, CCW (Barritech NP, Barritech VP, Barritech NP60, Barrithane VP, 705, 705 FR, 705 RS, 705 VP, 705 FR-A), Masterwall Rollershield, Keene Driwall Air Weather Barrier (AWB) High Permeability (HP), and Parex WeatherSeal Spray & Roll-On.
Exterior Insulation	Type II EPS (1.35 pcf max.) or Type IV XPS (1.55 pcf max.) foam plastic insulation may be used provided the insulation meets ASTM C578 and has maximum Total Heat (potential heat per inch x maximum thickness) of 6444 Btu/ft ² . <i>No exterior insulation or any non-combustible insulation such as unfaced mineral fiber may be used instead of the insulation described above.</i> Openings in assemblies that incorporate foam plastic insulation shall be finished using an opening nailing buck made up of three layers of minimum 1/2-inch-thick plywood to separate the openings from the wall assemblies at the headers, jamps, and sills.
Stucco Substrate	½-inch-thick National Gypsum PermaBase cement board substrate. The joints in the PermaBase shall be taped using PermaBase fiberglass tape.
Optional Rainscreen	Keene Driwall rainscreen as described in Section 3.2.3.3 of this report may be installed over the WRB or exterior insulation.
Lath	Woven-wire fabric lath, 20 gauge minimum, fastened in accordance with Section 3.2.1.5 or as required by code and type of substrate. Lath is not required for stucco over PermaBase.
Stucco	The QUIKRETE [®] One Coat FRS, One Coat FRS Concentrated, and Base Coat Stucco–Pump Grade shall be applied at a minimum thickness of ½ inch over ½-inch-thick the National Gypsum PermaBase substrate.

Note 1. Verification of compliance and equivalency is beyond the scope of this report, and is determined by a separate evaluation report, or as otherwise allowed by the building official.



TABLE 6 – NFPA 285 WALL ASSEMBLY WITHOUT FOAM INSULATION

Framing	No.20-gauge [0.035 inch (0.889 mm)] (min.) by 3 5/8-inch-wide (92 mm), non-load-bearing steel studs shall be spaced at a maximum of 16 inches (406 mm) on center. Wall openings shall be framed with a minimum 0.125-inch-thick (3.18 mm) steel or tubular aluminum. Alternate Framing: 2x4 or deeper non-bearing Fire-Retardant-Treated Wood (FRTW) studs spaced at 16 inches on center (406 mm) (min.) or a maximum of 24 inches on center (609 mm) meeting the requirements of IBC Section 2303.2 may be used instead of steel studs where fire-resistance-rated construction is not required in accordance with IBC Section 603.
Interior Panel	One layer of 5/8-inch-thick (15.9 mm) (min.) Type X gypsum wallboard shall be applied vertically on the interior side and attached with No.8 by 1¼-inch-long (31.8 mm) bugle-head screws spaced at 8 inches (203 mm) on center at board joints and 12 inches (305 mm) on center in the field. Gypsum wallboard fasteners and joints shall be taped and treated as set forth in Section 2508.4 of the IBC and either ASTM C840 or GA-216.
Fireblocking¹	Fireblocking consisting of a minimum density of 4 pcf (64 kg/m ³) mineral fiber insulation shall be installed in the wall stud spaces at the ceiling and floor levels in accordance with Section 718.2 of the IBC. The fiber insulation shall be a minimum nominally 4 inches (102 mm) thick, 6 to 8 inches (152 mm to 203 mm) wide, and sized to achieve a friction fit within the stud space.
Insulation	Any non-combustible insulation.
Exterior Sheathing	The exterior side shall have one layer of ½-inch-thick (12.7 mm) gypsum sheathing applied horizontally and attached with No.8 by 1¼-inch-long (31.8 mm) bugle-head screws spaced at 8 inches (203 mm) on center along all framing. Alternative Sheathing: Fire-Retardant-Treated plywood sheathing, ½-inch-thick (12.7 mm) (min.), meeting the requirements of IBC Section 2303.2 may be used instead of gypsum sheathing. Use of FRTW sheathing shall comply with IBC Section 603.
WRB¹	Tremco ExoAir 230 or another water-resistive barrier that is shown by ASTM E1354 testing (at 50 kW/m ² min. heat flux) and analysis to be equivalent in flammability. The following WRBs were tested and shown to be equivalent: Dupont Tyvek (CommercialWrap, CommercialWrap D), Dupont (Fluid Applied WB and WB-SP), Fortifiber WeatherSmart (Housewrap, Drainable, Commercial), Fortifiber Super Jumbo Tex 60 Minute, CCW (Barritech NP, Barritech VP, Barritech NP60, Barrithane VP, 705, 705 FR, 705 RS, 705 VP, 705 FR-A), Masterwall Rollershield, Keene Driwall Air Weather Barrier (AWB) High Permeability (HP), and Parex WeatherSeal Spray & Roll-On.
Optional Rainscreen	Keene Driwall rainscreen as described in Section 3.2.3.3 of this report may be installed over the WRB or exterior insulation.
Lath	Woven-wire fabric lath, 20 gauge minimum, fastened in accordance with Section 3.2.1.5 or as required by code and type of substrate.
Stucco	The QUIKRETE [®] One Coat FRS, One Coat FRS Concentrated, and Base Coat Stucco – Pump Grade shall be applied in accordance with Section 3.2.5 of this report.

Note 1. Verification of compliance and equivalency is beyond the scope of this report, and is determined by a separate evaluation report, or as otherwise allowed by the building official.



FIGURE 1 – Foam Plastic Tongue and Groove Horizontal Edge

QUIKRETE Lightweight FRS, One Coat FRS, One Coat FRS Concentrated, and Base Coat Stucco- Pump Grade

TONGUE and GROOVE DETAIL

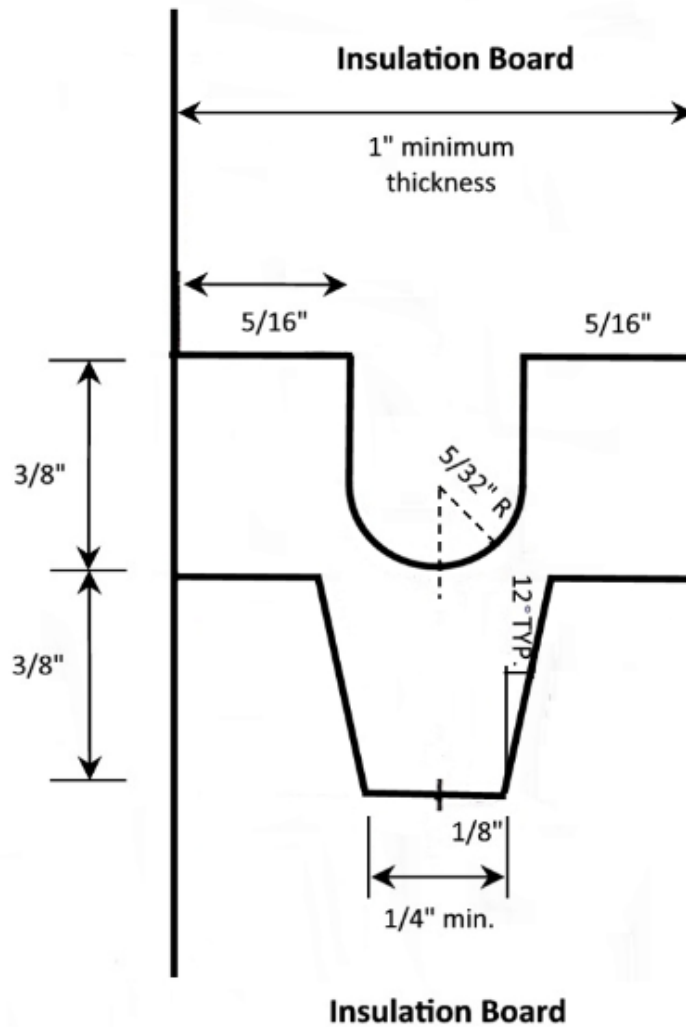



FIGURE 2 – One Coat FRS, One Coat FRS Concentrated, and Base Coat Stucco- Pump Grade Typical Installation Details

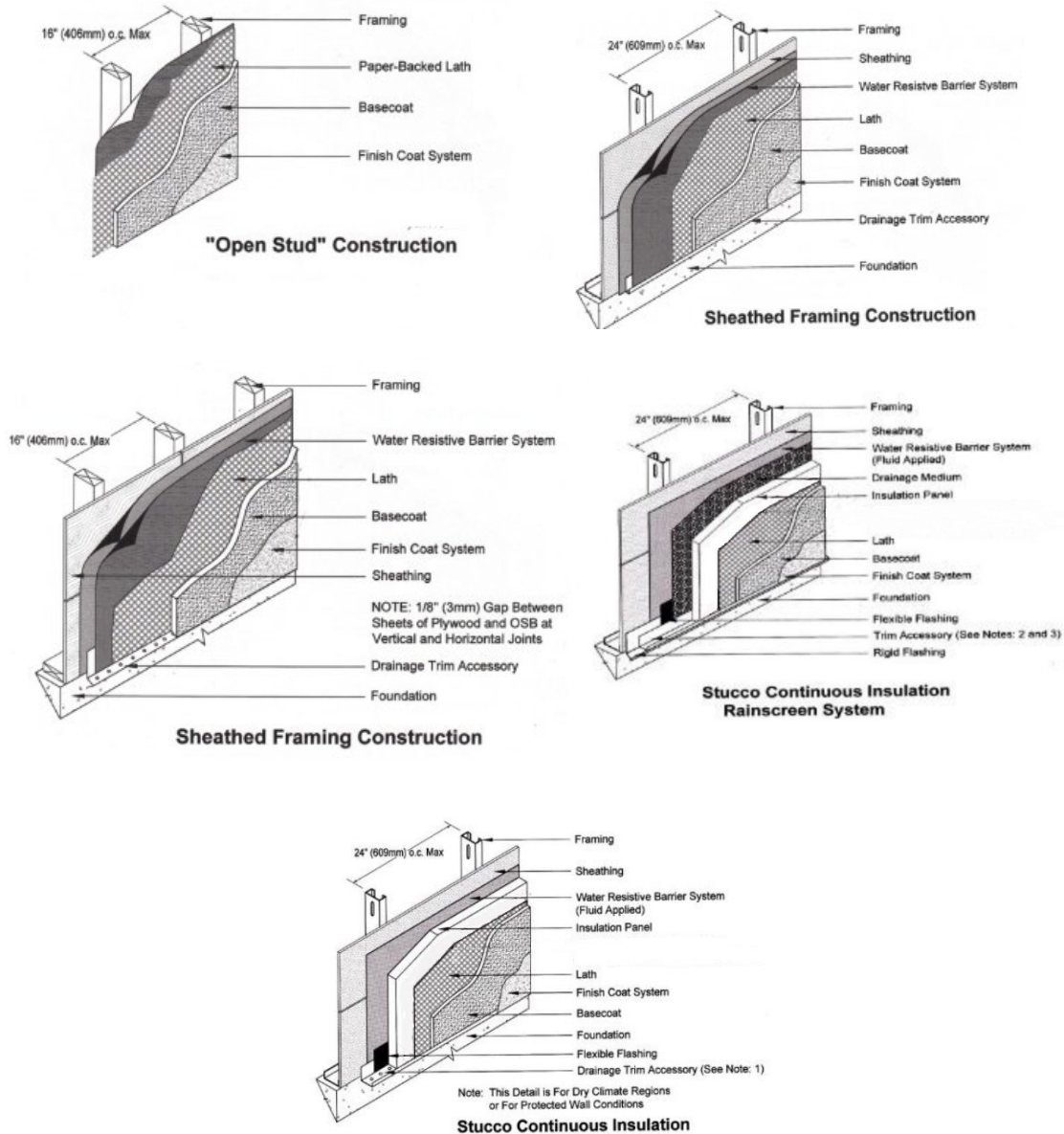
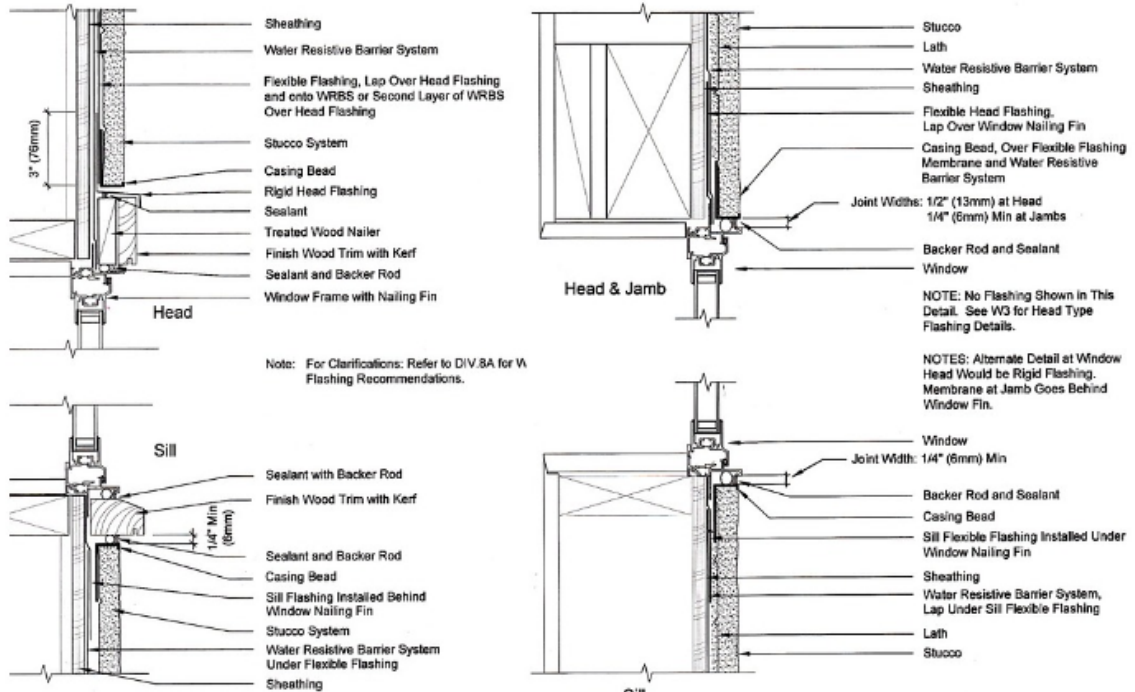

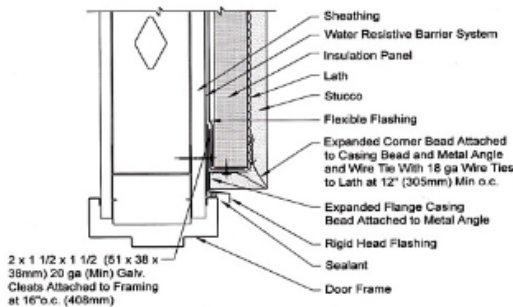

FIGURE 3 – One Coat FRS, One Coat FRS Concentrated, and Base Coat Stucco- Pump Grade Typical Installation Details



Nail-on Window with Wood Trim

Nail-on Window



Stucco Door Head Detail

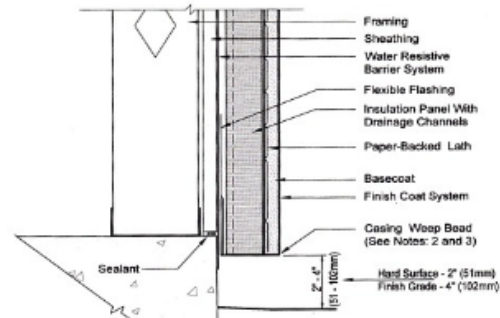

Stucco Base of Wall Detail

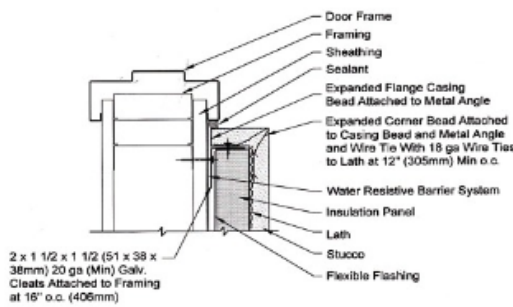

Stucco Door Jamb Detail

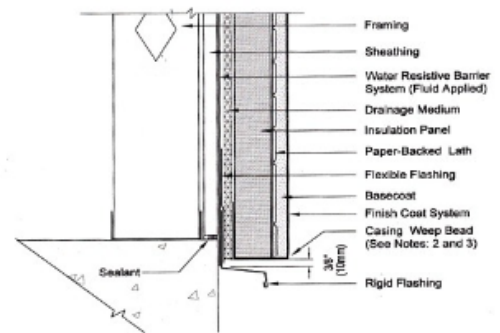

Stucco Base of Wall Detail

FIGURE 4 – One Coat FRS, One Coat FRS Concentrated, and Base Coat Stucco- Pump Grade Typical Installation Details

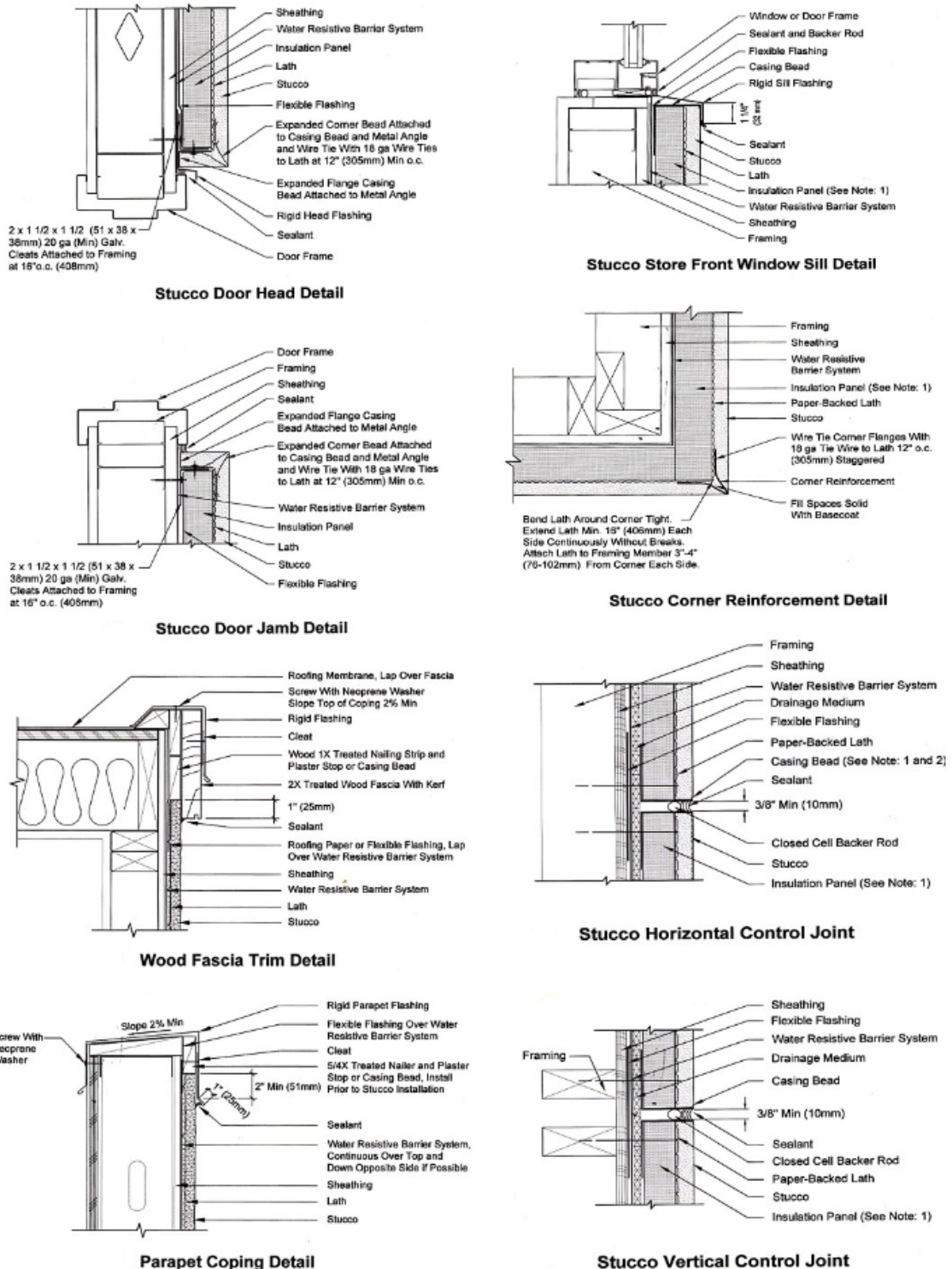
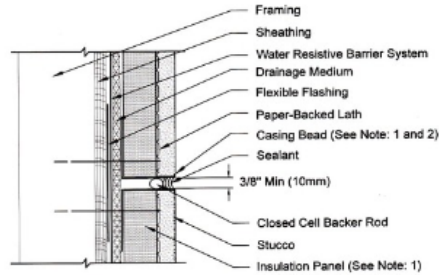
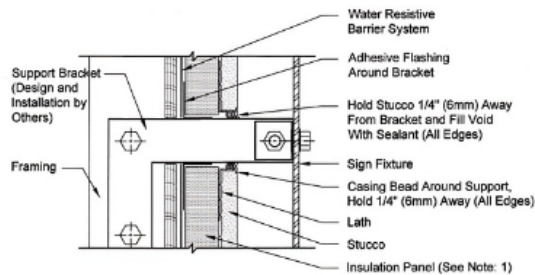

FIGURE 5– One Coat FRS, One Coat FRS Concentrated, and Base Coat Stucco- Pump Grade Typical Installation Details



Stucco Horizontal Control Joint



Penetrating Support Bracket Detail

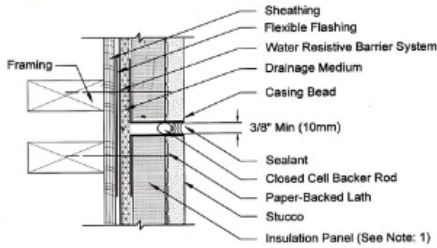

Stucco Vertical Control Joint

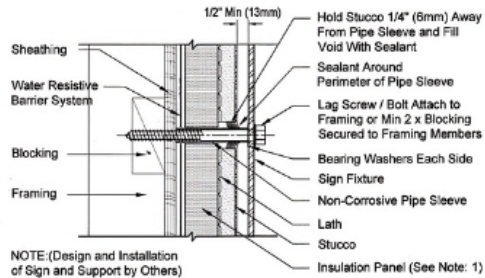

Stucco Through Wall Offset

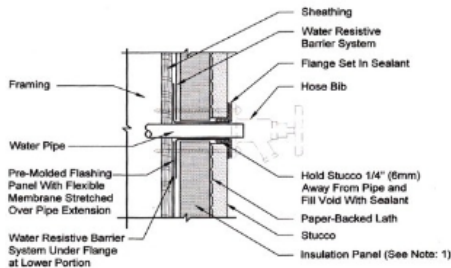

Stucco Hose Bib Through Wall Detail

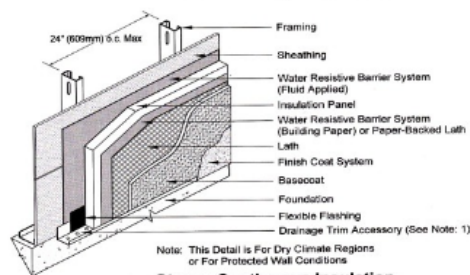

Stucco Continuous Insulation

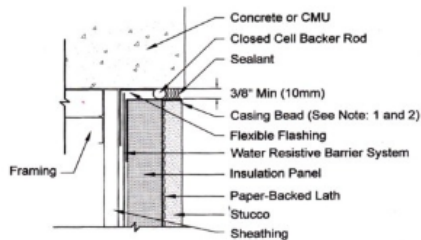

Stucco To Concrete / CMU Joint Detail

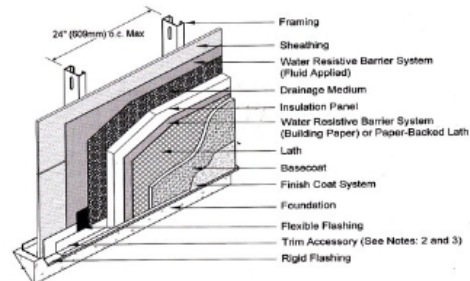

Stucco Continuous Insulation Rainscreen System



FIGURE 6 - Typical Installation Card

INSTALLATION CARD
QUIKRETE ONE-COAT FIBERGLASS REINFORCED STUCCO SYSTEMS
Quikrete Companies, Inc

Report holder number: ER 455

PROJECT NAME _____

PROJECT ADDRESS _____

PROJECT COMPLETION DATE _____

PLASTERING CONTRACTOR

Company: _____
Name: _____
Address: _____
Phone: _____
Email: _____

APPROVED CONTRACTOR NUMBER as issued by Quikrete Companies Inc.: _____

This is to certify that the exterior system on the building exterior at the above address has been installed in accordance with the Evaluation Report and the manufacturer's instructions.

SIGNATURE _____ DATE _____
Authorized plastering contractor representative



Originally Issued: 06/02/2017

Revised: 05/24/2022

Valid Through: 06/30/2023

CALIFORNIA SUPPLEMENT

THE QUIKRETE COMPANIES, LLC
500 Marathon Parkway
Lawrenceville, GA 30046
770-216-9580
www.quikrete.com

QUIKRETE® Lightweight Fiberglass Reinforced Stucco (Lightweight FRS) QUIKRETE® One Coat Fiberglass Reinforced Stucco (One Coat FRS), QUIKRETE® One Coat FRS Concentrated, and QUIKRETE® Base Coat Stucco - Pump Grade

ADDITIONAL COMPANY NAMES:

- **MasterWall, Inc.**
6975 Flat Rock Road
Midland, GA 31820
706-569-0092
- **STO Corp., Inc.**
3800 Camp Creek Parkway, SW
Atlanta, GA 30331
404-821-5972

CSI Section:

09 24 00 Cement Plastering

1.0 RECOGNITION

QUIKRETE® Lightweight Fiberglass Reinforced Stucco, QUIKRETE® One Coat Fiberglass Reinforced Stucco, QUIKRETE® One Coat FRS Concentrated, and QUIKRETE® Base Coat Stucco - Pump Grade evaluated in ER-455 are satisfactory alternatives to the following codes and regulations:

- 2019 California Building Code (CBC)
- 2019 California Residential Code (CRC)

2.0 LIMITATIONS

Use of the QUIKRETE® Lightweight FRS, One Coat FRS, One Coat FRS Concentrated, and Base Coat Stucco - Pump Grade recognized in ER-455 and this supplement are subject to the following limitations:

2.1 The QUIKRETE® Lightweight FRS, One Coat FRS, One Coat FRS Concentrated, and Base Coat Stucco-Pump Grade comply with Section 707A.3, item 1 of the CBC, and may be “used in the exterior design and construction of new buildings located within a Wildland-Urban Interface Fire Area” [Section 701A.1 of the CBC] when the additional provisions of Section 707A of the CBC are satisfied.

2.2 QUIKRETE® Lightweight FRS, One Coat FRS, One Coat FRS Concentrated, and Base Coat Stucco – Pump Grade comply with Section R337.7.3 item 1 of the CRC and may be “used in the exterior design and construction of new buildings located within a Wildland-Urban Interface Fire Area” [Section R337.1.1 of the CRC] when the additional provisions of Section R337.7 of the CRC are satisfied.

2.3 Protection against condensation shall be provided in accordance with Section R703.1.1 of the CRC.

2.4 This supplement expires concurrently with ER-455.

For additional information about this evaluation report please visit www.uniform-es.org or email us at info@uniform-es.org



FLORIDA SUPPLEMENT

THE QUIKRETE COMPANIES, LLC

500 Marathon Parkway
Lawrenceville, GA 30046
770-216-9580
www.quikrete.com

QUIKRETE® Lightweight Fiberglass Reinforced Stucco (Lightweight FRS) and QUIKRETE® One Coat Fiberglass Reinforced Stucco (One Coat FRS), QUIKRETE® One Coat FRS Concentrated, and QUIKRETE® Base Coat Stucco - Pump Grade

ADDITIONAL COMPANY NAMES:

- **MasterWall, Inc.**
6975 Flat Rock Road
Midland, GA 31820
706-569-0092
- **STO Corp., Inc.**
3800 Camp Creek Parkway, SW
Atlanta, GA 30331
404-821-5972

CSI Sections:

09 24 00 Cement Plastering

1.0 RECOGNITION

QUIKRETE® Lightweight Fiberglass Reinforced Stucco, QUIKRETE® One Coat Fiberglass Reinforced Stucco, QUIKRETE® One Coat FRS Concentrated, and QUIKRETE® Base Coat Stucco - Pump Grade evaluated in IAPMO UES ER-455 is a satisfactory alternative to the following codes and regulations:

- 2020 Florida Building Code, Building (FBC, Building)
- 2020 Florida Building Code, Residential (FBC, Residential)

2.0 LIMITATIONS

Use of the QUIKRETE® Lightweight FRS, One Coat FRS, One Coat FRS Concentrated, and Base Coat Stucco – Pump Grade recognized in ER-455 and this supplement are subject to the following limitations:

2.1 Use of the QUIKRETE® Lightweight FRS, One Coat FRS, One Coat FRS Concentrated, and Base Coat Stucco – Pump Grade for compliance with the high-velocity hurricane zone provisions (HVHZ) of the FBC, Building and FBC,

Residential have not been evaluated and are outside the scope of this evaluation report.

2.2 “In order to provide for inspection for termite infestation, clearance between exterior wall coverings and final earth grade on the exterior of a building shall not be less than 6 inches (152 mm)” in accordance with Section 1403.8 of the 2020 FBC, Building or Section R318.7 of the 2020 FBC, Residential.

2.3 Water-resistive barriers shall comply with Section 1404.2 of the 2020 FBC, Building or Section R703.2 of the 2020 FBC, Residential.

2.4 “The wind provisions of this code shall not apply to the design of buildings where the ultimate design wind speed, V_{ult} from Figure R301.2(4) equals or exceeds 115 miles per hour (51 m/s)” in accordance with Section R301.2.1.1 of the FBC, Residential.

2.5 “Flashing shall be installed in such a manner so as to prevent moisture from entering the wall or to redirect it to the exterior” in accordance with Section 1405.4 of the 2020 FBC, Building.

2.6 Flashing in accordance with Section R703.4 of the 2020 FBC, Residential shall be provided.

2.7 QUIKRETE® Lightweight FRS, One Coat FRS, One Coat FRS Concentrated, and Base Coat Stucco – Pump Grade manufactured for use in the state of Florida, at the Jacksonville and Lakeland, Florida facilities are limited to be used only in Florida.

2.8 For products falling under Section (5)(d) of Florida Rule 61G20-3.008, verification that the report holder’s quality assurance program is audited by a quality assurance entity, approved by the Florida Building Commission (or the building official when the report holder does not possess an approval by the Commission), to provide oversight and determine that the products are being manufactured as described in this evaluation report to establish continual product performance.

2.9 This supplement expires concurrently with ER-455.

For additional information about this evaluation report please visit www.uniform-es.org or email us at info@uniform-es.org