

RAVEN

GEOMEMBRANE  
CONTAINMENT  
SOLUTIONS

Environmental Liners & Covers



"We are dedicated to developing targeted product solutions that not only solve precise application challenges, but also integrate sustainable long-range accountability into our product designs."

— Raven Geo Team



## SUSTAINABLE PRODUCT FOCUS

For over 60 years, Raven Industries has manufactured and fabricated engineered geomembrane liners and covers to support the environmental sector and advance our mission of working to protect earth's resources. Our sales and engineering professionals support and understand the critical aspects of the geosynthetics industry. Our team is dedicated to developing targeted product solutions that not only solve precise application challenges, but also integrate sustainable long-range design accountability. Raven is a vertically integrated full-service solutions provider for the geosynthetic industry through world-class manufacturing and fabrication capabilities, design-build customization, and certified installation services.

We are a pioneer in designing and manufacturing advanced geomembranes with seven U.S. locations spanning across a 730,618 sq.ft. footprint that houses the very latest in state-of-the-art processing equipment. Capabilities include blown and cast sheeting, lamination/coating, and conversion in addition to an impressive GAI-LAP accredited testing lab and development facility. All Raven products are developed and produced in a quality controlled environment under our stringent ISO 9001 certified management system. We are fully committed to creating sustainable product solutions, and internally house a full-scale polymer reclamation center to capture excess polymers in-line with our green initiatives.

Raven manufactures wide-width master size rolls, large prefabricated geomembrane liners and covers, and consumer size converted rolls to meet all customer needs.



Raven Industries' extensive 60-year history in manufacturing and proven product expertise provides our customers with the most innovative and targeted product solutions available in the industry today.

## WHAT MAKES RAVEN UNIQUE?

As a vertically-integrated full-service solutions provider for the geosynthetics industry our capabilities in world-class manufacturing, design-build and installation services in conjunction with our solid commitment to operational excellence is what sets us apart from the competition. We offer some of the most diversified capabilities in the industry, as well as high standards for one-on-one customer service. You can draw from decades of experience, gained from processing and installing millions of pounds of polymer materials.

Raven's extensive engineering and R&D efforts are focused on developing customized solutions to meet specific requirements. We can take your project from resin pellet form to the final installation and inspection. Raven products are designed and manufactured through our 6-stage technical development process using comprehensive research and analysis, along with the latest design and manufacturing standards for value-added, competitive customer solutions.

We are an experienced manufacturer providing up to 9-layer blown sheeting capabilities, extrusion lamination and coating of reinforced materials, and large factory-welded panels up to 4 acres in size. We are a nationwide provider with seven strategically located manufacturing facilities located throughout South Dakota, Texas, Colorado, and California.

Raven takes pride in consistently delivering quality containment solutions, quick response times, and targeted product performance through a broad range of leading-edge geosynthetic solutions for the industry.

At Raven, we partner with our customers and work closely through our technical development process to create innovative, value-added, competitive product solutions.



## DEDICATED TO QUALITY

Raven is dedicated to creating innovative new products through our comprehensive product development solutions center, streamlining the process from conceptual design to full-scale production. We are a first choice in quality, housing an accredited laboratory with the latest in testing equipment (GAI-LAP Accredited). Raven is an industry provider of geomembranes designed to meet specific GRI-GM standards, critical NSF/ANSI certifications, along with many other federal, state, and local regulations and standards.



## SOLVING GREAT CHALLENGES

Raven Industries' ultimate purpose is to solve great challenges. We realize our vision by developing innovative solutions to great challenges related to the markets we understand and serve. Today, those solutions are focused on feeding and connecting the growing world population, preserving natural resources, and answering the growing need for security. Raven Engineered Films is committed to producing essential film and sheeting for the containment and protection of earth's natural resources. Creating solutions that not only solve precise application challenges, but integrate sustainable environmental design practices for long-term performance.



## LEADING MANUFACTURER

Raven Engineered Films is capable of processing a broad range of materials, however our focus for many decades has centered on polyethylene, flexible polypropylene, and advanced barrier geomembranes. We are the leader in reinforced polyethylene (RPE) and flexible reinforced polypropylene (fPPR) geomembranes with over 60 years of manufacturing expertise. These membranes have become the choice of specifiers due to their exceptional performance including chemical resistance, superior physical characteristics, longevity, high seam strength, and ease of installation along with many other benefits.

Raven produces a diversified geomembrane line-up to meet the needs of the geosynthetic industry including targeted membranes formulated to meet specific geotechnical requirements. We are proud to be members and sponsors of the leading geosynthetics associations and are committed to providing our support and expertise with the latest in geomembrane technologies, test methods, and installation procedures.

## ADVANCED GEOMEMBRANES

Standard geomembranes are primarily flexible polymeric materials either unsupported or supported with an internal reinforcement scrim. The industry typically offers a range of geomembrane types, all with unique qualities, that effect overall material performance. The Raven product line-up includes a wide-range of geomembranes including RPE, RPP, PVC, EPDM, CSPE, HDPE, LLDPE, fPP, along with all the supportive geosynthetic materials to complete seamless installations and performance. Raven products have specific features and qualities that effect long-term performance, installation processes, welding, chemical resistance, and barrier capabilities.

Raven Engineered Films is a leader in the design and manufacture of advanced geomembranes and we partner with our customers to develop cutting-edge product solutions. In addition to our industry leading flexible reinforced polyethylene and polypropylene geomembranes, Raven adds a new dimension to both unsupported and supported HDPE and LLDPE geomembranes through our advanced 7-layer cast and blown extrusion process.

Common geomembranes are intended to be used as a barrier to water, process fluids, leachates, hydraulic fracturing fluids, and many others. Critical containment applications and challenging specifications require more technically advanced geomembranes. Raven produces seven-layer, co-extruded membranes that serve a dual purpose as an effective barrier against non-polar substances such as radon, methane, and hazardous VOCs in addition to polar substances such as water. This is possible with the introduction of a chemically resistant advanced barrier layer formulated into supported and unsupported geomembranes with smooth or textured surfaces.

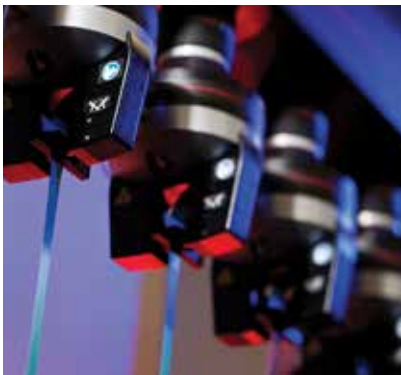



Raven specializes in producing reliable custom prefabricated drop-in panels up to 8,000 lbs (up to 4 acres) to optimize site coverage and significantly decrease install time and labor in the field.

## FABRICATED GEOMEMBRANES

Quality built prefabricated panels save considerable time on site by significantly decreasing the number of weather exposed installation days resulting in reduced project costs. With proper planning and custom designed panel layouts, a large portion of field seaming can be eliminated and replaced with higher quality factory certified seams produced in a controlled environment, which minimizes or eliminates destructive field seam testing. In many cases, a custom panel can be built as a one-piece drop-in solution. Raven also fabricates wide-width master rolls up to 60' wide to be further fabricated on-site increasing coverage optimization.

Raven custom fabricated panels are accordion-folded and rolled tightly on cores for optimized handling and shipping; panels are then easily deployed using the proper job-site equipment. These panels are all fabricated in a quality-controlled environment to meet the strict criteria of our ISO 9001 certified management system and tested in our internal (GAI-LAP) accredited laboratory. Raven produces large prefabricated panels up to 8,000 lbs (up to 4 acres) to be further joined in the field based on the project requirements.



Raven fabricates large one-piece panels that are accordion-folded and tightly rolled on cores for optimized handling and transportation.



Send in your project details and we will design a customized solution utilizing prefabricated panels to optimize your project footprint while eliminating excess liner waste.



Remember to utilize the Raven Online Calculators to quickly figure the liner size for your exact dimensions by visiting [www.RavenEFD.com](http://www.RavenEFD.com) and clicking the Tools tab.



Access the Raven site across all platforms! Whether you're in the field using a tablet or on an office desktop, the Raven website is fully responsive without missing a beat.

The Raven Modular Construction Model can save up to 80% of job-site seams for substantial savings in time and money by utilizing high quality prefabricated factory panels.



## MODULAR CONSTRUCTION MODEL

Raven has developed a geosynthetics system engineered with a modular construction design concept that utilizes the newest technology in multi-layered extrusion manufacturing combined with high-tenacity scrim reinforcement to increase strength and improve field performance. Raven engineers both the geomembrane performance and the fabricated panels to meet your specific requirements. This modular approach increases project quality, and significantly reduces construction time, and days on site.

By utilizing our extensive network of fabrication facilities and our talented team of construction professionals we can provide a system approach custom fabricated to the exact design dimensions of your facility, while eliminating up to 80% of geomembrane field seams to save time and money. We provide customers with easy-to-use site deployment drawings and utilize our engineered fabrication process to build large site-fitted panels in a climate controlled factory environment. Our construction field services team will utilize your site deployment drawings to design a tailored plan to align with your specific project details. Using this modular system, facilities can increase their bottom-line and realize substantial savings in site labor, weather risk potential, and days spent on site for deployment. Raven has developed an integrated approach to include world-class geomembrane manufacturing, quality fabrication, and certified installation to provide the civil and commercial construction segment with a turn-key solution for quality containment.

## CERTIFIED INSTALLATION SERVICES

In 2017, Raven acquired Colorado Lining International; a widely respected business partner with nearly 40 years of geosynthetics experience in custom fabrication, design-build expertise, and certified installation services. We since then, have formed an extensive network of qualified geosynthetics installation partners to facilitate our proven modular construction design concept.

Raven CLI Construction is an installation service subsidiary of Raven Engineered Films. They are an IAGI Approved Installation Contractor (AIC), a program to promote industry growth and provide higher quality workmanship. The IAGI program recognizes geosynthetic installation companies that meet a minimum level of professionalism, ethics and business practices. Approved installation contractors must meet requirements in the areas of corporate history and business practices, insurance verification, safety training, bonding, and professional industry competence and experience. Raven focuses on continuing education and training in an effort to employ experienced Certified Welding Technicians (CWT) within our installation team to provide unequalled customer service through reliable performance standards.

The adjacent water reservoir is approximately 16 acres and has 73% less field seams than the typical 60 mil HDPE layout shown. The modular approach provides value in lowering the risk on site by reducing the field hours, eliminating the majority of field seams, and giving the owners a functioning facility in half the time it would take to build with field welded HDPE. We can scale this modular construction concept to any size based on your specific project requirements. Our system approach can incorporate double-lined containment projects, as well as complete containment systems with integrated floating covers options.

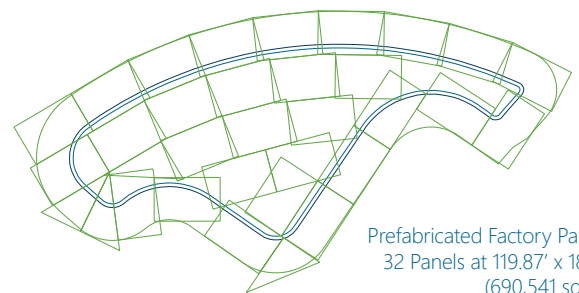

Prefabricated Factory Panels  
32 Panels at 119.87' x 180'  
(690,541 sq.ft.)  
9,000 LF - 6 Days On-site

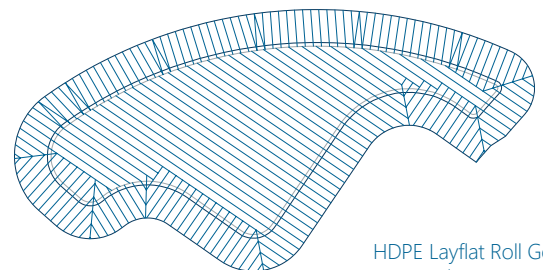

HDPE Layflat Roll Goods  
62 Panels at 22.5' x 540'  
(753,300 sq.ft.)  
33,000 LF - 9 Days On-site



Irrigation Pond

insubstantial

# CONTAINMENT APPLICATIONS

## POND LINERS/CONTAINMENT

Pond and general containment liner requirements are extremely broad depending upon the liquid contents, longevity expectations, soil conditions, geographical location, and many other factors. A thorough geomembrane selection that matches the containment requirements, in conjunction with proper construction methods and design, will result in a long-term reliable containment system.

Raven manufactures a wide-range of geomembrane liners to meet your individual containment requirements. You can choose from durable unsupported HydraFlex® LLDPE geomembranes ranging from 20 mil to 40 mil in various product families. HydraFlex® product families are designed to greatly exceed the physical properties of common LLDPE and other unsupported geomembranes. HydraFlex® geomembranes are available in a broad range of sizes including drop-in pond liners up to 78,000 square feet to greatly minimize installation time. Installers and fabricators prefer HydraFlex® due to the ease of welding during field installation. In addition to high-strength unsupported LLDPE pond and containment liners, Raven manufactures a full line of rugged Dura♦Skrim® N-Series reinforced geomembranes designed for pond liners and a wide range of other containment liners. Both of these products offer exceptionally high resistance to puncture and tear with an extremely low coefficient of thermal expansion, less than half of rigid HDPE geomembranes. The dense scrim reinforcement provides a rip-stop characteristic, which impedes tear propagation. The low temperature impact performance of reinforced polyethylene and flexible polypropylene is also far superior to that of PVC.

Dura♦Skrim® R-Series membranes range from light to medium weight materials as thin as 6 mil up to 30 mil for short to mid-term applications. Longer-term and highly demanding applications require our heavier reinforced Dura♦Skrim® N and NQ-Series geomembranes ranging in thickness from 30 mil up to 45 mil for long-term exposed applications. Custom engineered reinforced geomembranes are also available up to 80 mils thick depending upon the application requirements. Select N and NQ-Series reinforced geomembranes are available with our exclusive textured surfaces; GeoGrip™ and SurGrip™ to provide design engineers with new solutions for some of the most challenging projects. Exclusive Raven textures provide increased friction between various soil and geosynthetic layers allowing for steeper slope designs and also serve as an anti-skid surface, which is critical for applications requiring heavy foot traffic, especially in wet conditions.



## FLOATING COVERS

Floating covers are installed on lagoons, ponds, and reservoirs to protect the contents from evaporation, contamination, control odor, and many other purposes. Covers are commonly manufactured from geomembranes with high flex crack and weather resistance as they are typically subject to ever-changing liquid levels and continuous exposure to harsh outdoor conditions. In many cases, foot traffic is a common occurrence, requiring exceptionally resilient materials with high seam strength. Scrim reinforced materials provide unequalled tear resistance, high tensile strength, and excellent dimensional stability, all vital for long-term covers.



Raven manufactures Dura♦Skrim® N and NQ-Series reinforced geomembranes to provide an extremely durable floating cover option for the effective control of methane gas and odor emissions from animal waste. These materials offer tough puncture and tear resistance and are available in thicknesses from 30 mil up to 60 mil, depending on the series.

Raven's exclusive GeoGrip™ textured surface is also an option, consisting of durable random spikes and bidirectional bars for applications requiring an anti-skid surface. Raven Absolute Barrier® XB-Series 60 mil, is an HDPE geomembrane designed with an inner core of highly effective barrier resin to provide a solution for floating covers requiring exceptional chemical resistance to oils, greases, VOCs, and challenging odors. Uses for Absolute Barrier® include waste ponds, sewage ponds, dairy waste and anaerobic applications. Raven floating cover materials are available in either factory mill rolls or large fabricated panels to minimize installation time. Depending upon your application requirements and location, we can recommend a cover fabricator/installer to meet your individual needs.



## WASTE WATER LAGOON LINERS

Geomembranes play a vital role in protecting our environment. The Clean Water Act has addressed serious water pollution concerns since 1972, bringing awareness to the proper containment of waste water facilities across the United States. The Clean Water Act was created to restore and maintain the chemical, physical, and biological integrity of the nation's waters, by requiring the benefits of geomembrane containment systems used in waste water lagoons. The objective is to deliver a level of water quality that provides for the protection and propagation of fish, shellfish, and wildlife in general. According to the NRCS, geomembranes designed to restrict and control

seepage of water and contaminants from water and waste water impoundment structures for environmental protection, require a minimum of thickness 40 mil HDPE, LLDPE, or fPP. If the geomembrane is reinforced, 36 mil RPE and RfPP are acceptable minimums.

Raven provides large, custom fabricated one-piece drop-in liners designed for ease of installation and to control waste seepage contamination as well as fresh water containment for on-farm use. Raven Dura♦Skrim® N-Series are rugged puncture and tear resistant reinforced liners available in smooth or textured 36 mil and 45 mils thick. Raven's exclusive GeoGrip™ texture consists of durable random spikes and bidirectional bars for uniform stabilization and support. GeoGrip™ friction surface provides design engineers with new solutions for some of the most challenging projects. Raven Dura♦Skrim® N-Series are formulated with thermal and UV stabilizers to assure a long service life. These durable liners will easily outperform 60 mil unsupported geomembranes, as well as being easier to handle in the field. Non-reinforced liner options include Raven HydraFlex® Ultra 40 mil, a flexible linear-low-density geomembrane with excellent puncture resistance and conforming characteristics.

## BROWNFIELD/GAS BARRIERS

A brownfield is a property, expansion, redevelopment, or reuse of, which may be complicated by the presence of a hazardous substance, pollutant, or contaminant. It is estimated that there are more than 450,000 brownfields in the U.S. Cleaning up and reinvesting in these properties protects the environment, increases local tax bases, and facilitates job growth. Once a brownfield site has been remediated of known contaminants, valuable redevelopment can take place in the form of parks, shopping centers, and housing.



This is where a true gas barrier to VOC pollutants such as gasoline, diesel, dry cleaning fluids, solvents, and other toxic materials is vital when choosing an under concrete slab gas barrier to minimize gas and vapor intrusion into a building or other enclosed structure. Depending upon specific site conditions, gas barriers can also be designed to protect open areas, including redeveloped city parks or golf courses and other recreational areas.

Raven manufactures VaporBlock® Plus™ and a full line of Absolute Barrier® products designed to be placed directly below concrete slabs. VaporBlock® Plus™ is a 20 mil thick membrane formulated to mitigate gas and moisture migration into the building envelop when properly installed to provide protection from toxic/harmful chemicals. It can be installed as part of a passive or active control system extending across the entire building including floors, walls, and crawl spaces. When installed as a passive system, it is recommended to also include a ventilated system with sump(s) that could be converted to an active control system with properly designed ventilation fans.

Absolute Barrier® geomembranes are constructed in the same manner as VaporBlock® Plus™, ranging in thickness from 30 mil up to 60 mil depending upon the application requirements. Both contain a seven-layer co-extruded structure consisting of very flexible, linear-low-density polyethylene (LLDPE) or highly chemical resistant HDPE outer layers with an inner core of advanced barrier resin, designed specifically as a barrier against radon, methane, and VOCs. Absolute Barrier® geomembranes are designed to stop gas vapor migration on Brownfield sites, in residential and commercial buildings, as well as geomembrane containment, and covering systems.



## LANDFILL COVER/CAPS

The main purpose of a landfill cap is to control landfill gas, odor, and rain from entering the landfill, minimizing the amount of leachate that needs to be treated and disposed. A significant cost of landfill operations is the pumping and treatment of leachate. Geomembrane caps need to be able to withstand the strains and stresses that occur from differential settlements. This is common with the decomposition and shifting of waste, for that reason LLDPE and fPP are the covers of choice in buried cap applications.

Exposed geomembrane caps are becoming more common in the industry, as this helps to solve potential issues with side slope failures. Thermal/UV stability, wind, and gas uplift challenges have to be taken into consideration when designing exposed landfill caps, in addition to differential settlement. One of the most challenging aspects of capping a landfill is odor control. Hydrogen sulfide and other odor producing compounds will travel, in vapor form, through standard HDPE, LLDPE, or PVC capping materials into the open environment. This is especially problematic in older landfills that accepted industrial wastes including a wide range of VOCs. Continuous offensive odors can lead to multiple violations from state and federal regulators, as well as generate lawsuits from neighbouring communities.

## LANDFILL COVER/CAPS CONTINUED

Raven has very effective capping solutions to minimize landfill odor transmission. Absolute Barrier® geomembranes offer the latest in gas barrier technology for Odor Control Barriers (OCB) used in landfills and other challenging municipality applications. The Absolute Barrier® geomembrane line is available in linear-low-density or high-density, with a smooth or textured surface. Absolute Barrier® XT-Series 60 mil is a seven-layer co-extruded textured geomembrane consisting of durable high-density polyethylene (HDPE) and an inner core of highly effective barrier resins, designed specifically as an exposed barrier against methane, radon, landfill odors, and VOCs. The high-strength HDPE outer layers provide excellent chemical resistance and outdoor durability. A robust stabilization package that exceeds industry standards, provides long-term protection from thermal oxidation, and ultraviolet degradation in exposed applications. The aggressive surface texture provides excellent stabilization for earthen covers and secondary geosynthetics as well as work site safety. Wide-width lay-flat mill rolls are also available for further seaming in the field.

Raven offers the same odor/gas barrier technology in an interim landfill cover solution with a 20 mil scrim-reinforced material. Dura♦Skrim® RB-Series incorporates high-strength reinforcement with an advanced gas barrier designed to provide an effective barrier to landfill odors and gases. The RB-Series is manufactured with an outer ply consisting of seven-layers including high performance polymers with an integrated core of chemically resistant barrier resin. This limits migration of volatile organic compounds including methane, halogenated hydrocarbons, aromatic hydrocarbons, and odors. The barrier layer is more effective than standard polyethylene in gas and odor control, while providing the same strength and toughness expected from patented Dura♦Skrim® scrim-reinforced membranes.

## COAL ASH CONTAINMENT

In the U.S., about 40% of the electricity produced is generated from coal-fired power plants due to coal's abundance and effectiveness. A by-product of coal combustion is known as Coal Combustion Residue (CCR), which consists of fly ash, boiler slag, bottom ash, and flue gas desulfurization. CCRs are the second largest waste stream in the U.S. and is only second to municipal solid waste. Many industries make a profound impact on our environment, coal ash is no exception, with the potential for containment failures.

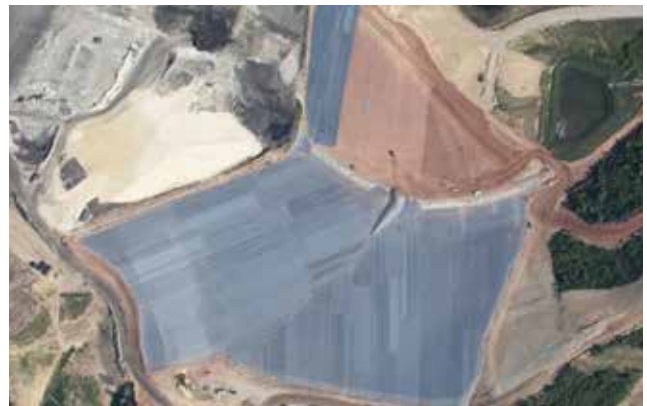

On October 19, 2015, Disposal of Coal Combustion Residuals from Electric Utilities final ruling became effective. It provides safeguards for the proper handling, storage, and impoundments of CCRs. This regulation is geared to protect drinking water from hazardous contamination, prevent air emissions of coal ash dust into the environment, and foremost, to help protect communities from catastrophic failures of coal ash surface impoundments. The rule was promulgated under subtitle D (non-hazardous solid waste) of the Resource Conservation and Recovery Act. The new requirements call for a single composite liner consisting of at least a 30 mil flexible geomembrane placed over a compacted clay liner, or if it is a HDPE geomembrane, it must be a minimum of 60 mil and placed over a compacted clay liner.

Coal Ash is a silt sized particle that is highly susceptible to erosion and changes in moisture content. Leachate generated from uncovered coal ash can be extremely expensive to address. Raven manufactures a wide range of temporary covers ranging from highly stabilized 8 mil to longer-term 20 mil depending upon the storage requirements. Dura♦Skrim® NT-Series reinforced textured 45 mil geomembrane provides the ultimate in strength, longevity and slope stability as a permanent capping material. Raven also offers HydraFlex™ Ultra HU-Series, consisting of highly flexible LLDPE unsupported containment liners in 30 mil and 40 mil thickness for primary containment when placed over a compacted clay liner.

Raven Industries has a long history of manufacturing high performance geomembranes for the environmental sector and is fully committed to producing essential products for the containment and protection of earth's natural resources. Raven designs and fabricates large one-piece panels to maximize site coverage and minimize on-site field seaming, saving time and money. Coal ash impoundment liners and covers are prefabricated in a quality-controlled factory environment, to guarantee consistent seam integrity and overall performance.

## MINING

Since 1970, geomembrane liners have been utilized by the mining industry. This is a very challenging application considering geomembranes are subjected to leachate properties, harsh environmental conditions, and extremely heavy loads depending on the particular function. Geomembranes have become a significant factor in mining operations based on their containment ability. Major applications include HDPE and LLDPE heap-leach pads in thickness of 60 mil to 80 mil; process solution, and overflow ponds commonly require 30 mil to 40 mil LLDPE. To prevent concentrated mine chemicals from being released into the environment, tailing dams are designed to accumulate remaining solids from the mining operation in which 40 mil HDPE, LLDPE, and fPP are widely used. Raincoats or temporary covers are also used on heap-leach pads to reduce dilution of operating solutions consisting of 30 mil to 60 mil LLDPE. Inter-lift liners are designed to reduce acid consumption in heap-leach solutions and typically consist of 30 mil to 40 mil LLDPE.



Raven offers a complete line of reinforced and unsupported geomembranes for rain covers, tailing dams, temporary covers, solution ponds, overflow ponds, and many other containment needs. Our heavy-duty reinforced Dura♦Skrim® N-Series ranges from 30 mil up to 45 mil in smooth or textured versions depending upon site requirements. In applications that do not require reinforced materials, we also offer a wide-range of high-strength HydraFlex™ Ultra LLDPE geomembranes in a variety of thickness and size configurations starting with 20 mil up to 40 mil. Raven fabricates geomembranes into large one-piece drop-in panels up to 8,000 pounds (up to 4 acres) for time-saving installation.



## GEOFOAM PROTECTION AND ENCAPSULATION

Geofoam is manufactured from expanded polystyrene (EPS) or extruded polystyrene (XPS), and is available in a wide range of large lightweight blocks cut to size up to 50 square feet. The primary function of geofoam is to provide a lightweight void fill below highways, bridge approaches, airport taxiways, rail embankments, and more. One of the main challenges with Geofoam is its low resistance to chemical exposure with a high damage potential from chemicals such as gasoline, diesel fuel, organic solvents, and other harmful liquids or vapors. Standard

geomembranes are intended to provide protection, however, they are not impermeable to gas vapors. Extensive testing and field experience has demonstrated that an engineered geomembrane with an advanced barrier core will provide superior protection and greatly minimize the migration of harmful chemicals—protecting the Geofoam from premature degradation.

Raven Absolute Barrier® Y-Series geomembranes are produced in 30 mil and 40 mil and contain a seven-layer co-extruded structure consisting of very flexible, linear low-density polyethylene (LLDPE) outer layers, with an inner core of chemically resistant barrier resin. They are designed specifically as a barrier against gasoline, diesel, VOCs, and other hazardous liquids when encapsulating Geofoam structures. These advanced barriers are 300x to 500x lower in gas permeability than traditional LLDPE, and most common unsupported or supported geomembranes on the market today—including many membranes that are specifically marketed as chemically resistant.

# Potable Water Reservoir





## RAVEN GEOMEMBRANE LINE-UP

Raven's unique product line-up includes geomembranes designed to provide effective containment of liquids, solids, odors, and hazardous gases. This is achieved through our multi-layer gas barrier technology and our ability to introduce tough reinforcements and precision textures, unlike any others in the industry. In the environmental sector, Raven geomembrane liners and covers protect our surroundings through proven containment solutions.



### Absolute Barrier® Y-Series – LLDPE 7-Layer Barrier

Y-Series (30-40 mil)—Seven-layer co-extruded geomembranes consisting of very flexible, linear-low-density polyethylene with an inner core of chemically resistant advanced barrier resin, designed specifically as a barrier to effectively block radon, methane, and harmful VOCs. High strength LLDPE provides exceptional tear, impact resistance and flexibility. Y-Series is designed to restrict the migration of volatile organic compounds including methane, halogenated hydrocarbons, aromatic hydrocarbons and odors. Y-Series prevents gas vapor migration in critical Brownfield redevelopment and vapor intrusion applications. Absolute Barrier® is highly effective in preventing the degradation of EPS geofoam by protecting it from direct contact with harsh VOCs.

### Absolute Barrier® X & XT-Series – HDPE Barrier & Textured Barrier

X-Series (40-60 mil) and XT-Series (60 mil)—Seven-layer co-extruded geomembranes consisting of chemically resistant high-density polyethylene with an inner core of advanced barrier resin. X & XT-Series are highly resilient vapor intrusion barriers designed to restrict naturally occurring gases with effective control for volatile organic compounds including methane, halogenated hydrocarbons, aromatic hydrocarbons, and odors. Provides unmatched impact strength along with advanced barrier performance over 100x more effective than standard polyethylene against harmful VOCs. XT-Series is nitrogen textured and contains a robust stabilization package that exceeds industry standards, providing long-term protection from thermal oxidation and ultraviolet degradation.



# RAVEN GEOMEMBRANE LINE-UP

Raven produces a complete line of next generation scrim-reinforced geomembranes in both polyethylene and polypropylene series to meet the unique requirements of the geosynthetics industry. We design products to meet and exceed the GRI-GM standard specifications as written by the Geosynthetic Institute, and certifications for NSF/ANSI Standard 61, along with state and federal regulations to make product selection simple.



## Dura♦Skrim® R & RB-Series - LLDPE Reinforced & Barrier Reinforced

R-Series (6-24 mil)—Reinforced high-strength linear-low-density polyethylene containing carbon black, UV inhibitors, and thermal stabilizers in a four-layer reinforced extrusion laminate with tough diagonal-direction scrim reinforcement. R-Series membranes range from light to medium weight materials for short to mid-term applications with select products for temporary to 10-year outdoor cover applications. RB-Series (20 mil) integrates an advanced gas barrier core layer to effectively control hazardous VOCs, radon, odors, and methane gas migration. Dura♦Skrim® R-Series 8BV, 12BV, and R24BV meet GRI-GM22 Standard Specifications.

## Dura♦Skrim® J & JT-Series - LLDPE Reinforced & Reinforced Textured

J & JT-Series (30-36 mil)—Durable scrim-reinforced flexible geomembranes available in a smooth reinforced and a unique, single-side textured reinforced manufactured using high strength virgin polyethylene resins. J & JT-Series are reinforced with a tri-directional scrim-reinforcement to maximize tear and puncture resistance. JT-Series is produced using a cast extrusion process to achieve a consistent friction surface with uniform asperity heights. Raven's exclusive GeoGrip™ surface texture provides increased friction between various soil and geosynthetic layers allowing for steeper slope designs. J & JT-Series membranes are formulated with thermal and UV stabilizers to assure a long service life.

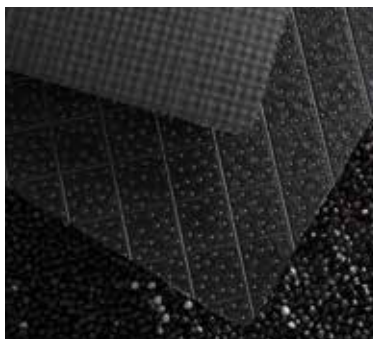
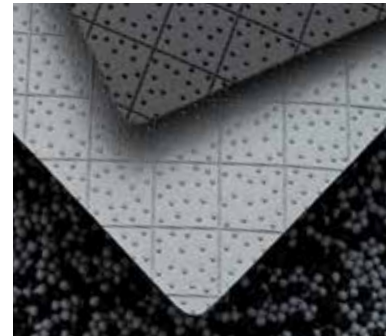

## Dura♦Skrim® N & NT-Series - LLDPE Reinforced & Reinforced Textured

N-Series and NT-Series (30-45 mil)—Heavy-duty scrim-reinforced flexible geomembranes, reinforced with a close knit 9x9, 1000-denier polyester and fully encapsulated in a highly UV stabilized lineal-low-density polyethylene. Exceptional toughness and a highly stabilized formulation provide excellent protection for long-term exposed applications. NT-Series is manufactured utilizing cast extrusion to achieve a consistent textured friction surface with uniform asperity heights. Exclusive GeoGrip™ texture provides increased friction between various soil and geosynthetic layers allowing for steeper slope designs. N-Series and NT-Series are certified under NSF/ANSI Standard 61, Drinking Water System Components - Health Effects, and also meet the physical property values as stated in GRI-GM25 Standard Specifications.

## Dura♦Skrim® NQ & NQT-Series - Flexible Reinforced Polypropylene

NQ-Series (36-45 mil) and NQT-Series (45 mil)—Highly flexible reinforced polypropylene geomembranes reinforced with close knit 9x9 weft inserted polyester scrim between two-layers of highly UV stabilized polypropylene. Exceptional flexibility is achieved by incorporating high levels of ethylene propylene rubber into polypropylene along with a dense scrim reinforcement, resulting in excellent dimensional stability and physical properties. NQT-Series contains a one-side cast extrusion textured surface featuring the latest Raven SurGrip™ texturing. SurGrip™ texture consists of diagonal cross-hatched patterning with uniform raised self-draining tread bars. NQ & NQT-Series provides outstanding resistance to environmental stress cracking and is certified under NSF/ANSI Standard 61, Drinking Water System Components - Health Effects.



# RAVEN GEOMEMBRANE LINE-UP

Raven geomembranes meet the challenging requirements of the geosynthetics industry, from highly flexible and conforming liners to durable long-term textured liners and covers designed to withstand abuse; we have the products to meet your toughest demands. You can install with confidence knowing that our experienced team will provide you with the right product for your application.



## HydraFlex® H-Series - Economy Grade LLDPE

H-Series (20-40 mil)—Co-extruded geomembranes consisting of virgin linear-low density polyethylene outer layers and an inner core of virgin and select reprocessed resins. H-Series membranes are stabilized with carbon black and antioxidants designed as an economical solution for temporary and non-critical applications. The premium quality outer layers of the H-Series product line offers exceptional value including ease of welding along with high impact and tear resistance. H-Series has over 11% greater tensile and 33% greater puncture strength than competitive geomembranes mil-for-mil. H-Series is recommended for general mid-term applications requiring up to 5 years of exposed longevity.

## HydraFlex® HT-Series - Economy LLDPE Textured

HT-Series (30-40 mil)—Co-extruded one-side textured linear-low-density polyethylene (LLDPE) geomembranes containing carbon black and ultraviolet inhibitors to ensure protection against harmful UV degradation. HT-Series one-side textured LLDPE provides increased friction, elongation, and flexibility. Available in black and black/gray color options with the gray side providing a cooler surface against contrasting colors and a vital function for ease of damage detection during installation. HT-Series is used in applications demanding increased friction resistance characteristics in sloped areas. These highly flexible geomembranes will conform to uneven subgrades.

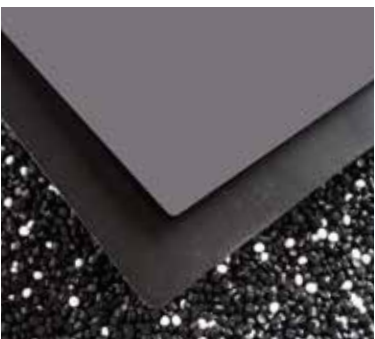
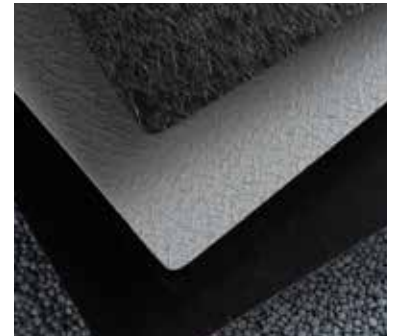

## HydraFlex® Pro HP-Series - Very Flexible LLDPE

HP-Series (30-40 mil)—Premium grade polyethylene liners designed with enhanced flexibility, and pinhole resistance as demonstrated by its low modulus characteristics. These properties are critical for applications requiring exceptional flexibility and high impact strength such as above ground tank lining systems. The optional gray top-layer minimizes thermal expansion and maintains a cooler surface. HP-Series has 48% higher tensile strength and 33% higher puncture resistance than common unsupported geomembranes mil-for-mil. HydraFlex® Pro has an estimated longevity of 15 years with the gray surface exposed.

## HydraFlex® Ultra HU-Series - Very Flexible LLDPE – Meets GRI-GM17

HU-Series (20-40 mil)—Premium LLDPE geomembranes designed for applications requiring superior outdoor longevity, chemical resistance, and exceptional durability, even in cold weather environments. Virgin-grade high strength LLDPE provides 36% greater tensile and 37% higher puncture mil-for-mil resistance as required by GRI-GM17. HU-Series meets or exceeds GRI-GM17 Standard Specifications for linear-low-density geomembranes, with excellent performance in water and waste water applications for commercial and municipal projects. HU-Series is highly flexible and conforms easily to uneven surfaces and is engineered to be used in more critical applications including the fish-safe requirements for aquaculture.





# RAVEN GEOMEMBRANE LINE-UP

Raven manufactures a wide-range of flexible unsupported geomembrane liners to meet your individual containment requirements. Choose from wide variety of flexible geomembranes ranging from 20 mil to 120 mil and very flexible in 30 mil to 60 mil thickness. All designed to greatly exceed the physical properties of common polyethylene and other unsupported geomembranes.



## HydraFlex® PP & V-Series - Very Flexible PP and Very Flexible PE

PP-Series (40 mil) and V-Series (30 mil)—Exceptionally flexible geomembranes, the PP-Series is achieved by incorporating high levels of ethylene propylene rubber into polypropylene. HydraFlex™ PP-Series provides outstanding resistance to environmental stress cracking even at elevated temperatures in addition to aggressive chemical environments. The V-Series consists of prime very-low-density polyethylene for superior elongation, tear resistance, and burst strength. HydraFlex™ PP and V-Series do not contain plasticizers that can migrate to the surface, causing premature aging, and will remain flexible and conforming to challenging terrains without environmental stress crack issues often seen with common HDPE membranes.

## HydraFlex® EP-Series - Very Flexible EPDM

EP-Series (45-60 mil)—Ethylene Propylene Diene Terpolymer (EPDM) is a type of elastomer synthetic rubber characterized by a wide range of applications. EP-Series geomembranes are a terpolymer of ethylene, propylene, and a diene-component. HydraFlex™ EP-Series is a waterproof membrane that has a 20-year proven performance history in exposed applications. HydraFlex™ EP-Series exhibits high tensile strength and excellent resistance to punctures, UV radiation and weathering. The EP-Series contains highly flexible materials with a low co-efficient of thermal expansion and contraction. This enables the membrane to lay flat in a wide range of temperatures and terrains while conforming to irregularities within the sub grade.

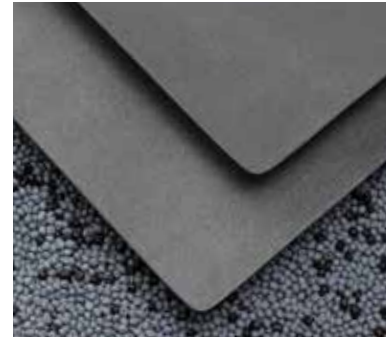

## HydraFlex® PV-Series - Flexible PVC

PV-Series (20-60 mil)—Poly Vinyl Chloride (PVC) geomembranes are non-reinforced and are commonly specified as a liner material. The HydraFlex™ PV-Series is manufactured to be a highly flexible, cost-effective, waterproofing geomembrane. HydraFlex™ PV-Series has excellent abrasion resistance and is resistant to a number of industrial chemicals. High flexibility characteristics allow the PV-Series to be readily conformable to subgrade and terrain contours, while providing excellent interface friction and abrasion resistance without a textured surface. The HydraFlex® PV-Series requires 12 inches of clean cover soil and if properly covered it can provide a service life of up to 20 years.

## HydraLine™ LL-Series - Flexible LLDPE Layflat - Meets GRI-GM17

LL-Series (20-120 mil)—Linear-low-density polyethylene (LLDPE) geomembranes are manufactured with high quality resins providing excellent elongation, multi-axial stress resistance, and flexibility conforming to various surfaces. LL-Series is sold in 22.5' or 23' layflat mill rolls and requires specialized welding equipment and certified welding technicians to be installed properly. LL-Series can be heat sealed with hot wedge or extrusion welding technologies. The LL-Series geomembranes feature high tensile strength, UV stability, and resistance to environmental stress cracking. HydraLine™ LL-Series meets the physical property values as stated in GRI test method GM17. Available in black, white, and custom colors with minimum quantity order requirements.



# RAVEN GEOMEMBRANE LINE-UP

The entire Raven geomembrane product line includes RPE, RPP, PVC, EPDM, CSPE, HDPE, LLDPE, fPP membranes, along with all the supportive geosynthetic materials to complete a turn-key project solution. All Raven products have specific features and qualities that effect long-term performance, installation processes, welding, chemical resistance, and barrier capabilities just to list a few. The Raven geosynthetics team can provide you with specific solutions based on your exact project requirements.



## HydraLine™ HD-Series - HDPE Layflat – Meets GRI-GM13

HD-Series (20-120 mil)—High-density polyethylene (HDPE) geomembranes contain UV stabilizers to provide exceptional longevity and product durability. HydraLine™ HD-Series has great chemical resistance and a fairly low permeability. HD-Series is sold in 22.5' or 23' layflat mill rolls and requires specialized welding equipment and certified welding technicians to be installed properly. The HD-Series membranes can be heat sealed with hot wedge or extrusion welding technologies. HydraLine™ HD-Series meets the physical property values as stated in GRI test method GM13 standard specifications. Available in the color black, and custom colors with minimum order quantity requirements.

## CSPE M-Series - Chlorosulfonated Polyethylene – Meets NSF 61

M-Series (36-90 mil)—Chlorosulfonated polyethylene reinforced flexible geomembranes provide an exceptional service life. M-Series is a synthetic rubber product manufactured through a calendaring process into plies over a reinforcing polyester scrim layer. The M-Series is available in 3-ply layers and 5-ply layers with up to two reinforcing layers. The M-Series are highly UV stabilized to be used extensively in municipal water containment. They have exceptional durability and longevity. M-Series materials are available in varying styles, colors, plies, thickness, supporting scrim types, and come with a 30-year weathering warranty for approved CSPE applications.

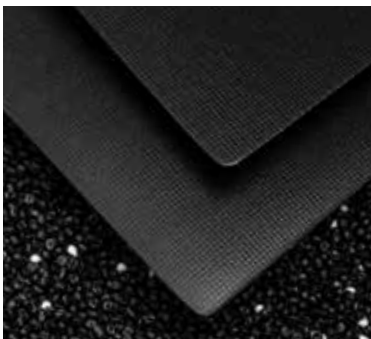
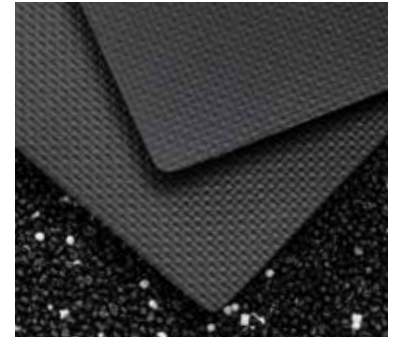

## XR-5® XR-Series - Ethylene Interpolymer Alloy

XR-Series (30-40 mil)—Chemically resistant geomembranes manufactured with an outer coating of Ethylene Interpolymer Alloy (EIA). XR-Series is reinforced with an extremely tough woven synthetic fabric coated with a unique polymeric adhesive, providing a molecular bond between the compounded EIA coating and the reinforcement layer. XR-Series membranes provide low thermal expansion and are dimensionally stable under high loads and temperature fluctuations. XR-Series is extremely chemically resistant with high puncture and tear properties and is designed to contain and protect against acids, oils, methane, alkalis, and is capable of performing in harsh environments.

## GCL GC-Series Bentonite® - Geosynthetic Clay Liners

GC-Series (Bentomat & Bentomat/Claymax)—Bentonite-based GCLs are designed to provide hydraulic barriers against many leachates. The GC-Series includes a multitude of liner options from bentonite combined with woven and non-woven needle-punched geotextiles to complete composite laminate geosynthetic liners. GCLs are a great secondary or supportive layer used in conjunction with the right geomembrane. GCLs are known to provide consistent low permeability with the unique ability to seal around penetrations, and self-heal punctures and overlaps. Bentonite-based GCLs provide a high-performance, cost-effective alternative to compacted clay liners. The use of GCLs and the proper liner are an exceptional solution to sub-grade and leak protection issues.



# RAVEN MANUFACTURING CAPABILITIES

## Blown Film and Sheeting:

- Mono-Layer up to 9-Layer Blown Film & Sheeting
- Single Wound Sheeting up to 276" Wide
- Multi-Layer Film from 0.50 mil up to 80 mil Thick
- Large Mill Rolls up to 48" Diameter
- Capable of Processing Wide-Range of Resins
- Textured Surfaces (Nitrogen Injected)
- Gas Impermeable 7-Layer Structures

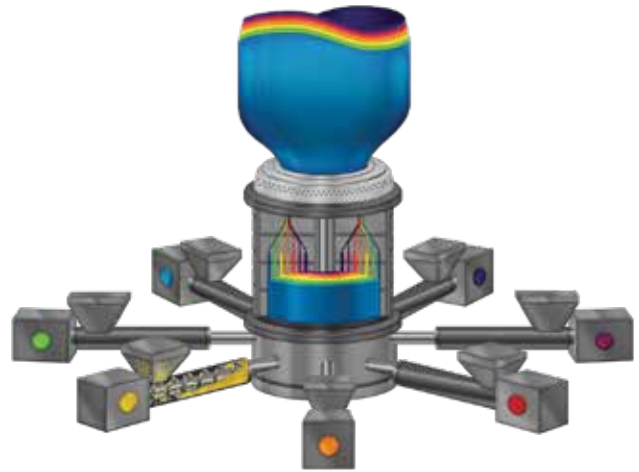

7-LAYER BLOWN EXTRUSION

## Cast/Lamination/Coating Capabilities:

- Reinforced Composite Structures up to 146" Wide
- Wide-Range of Reinforcement Options
- 3 mil to 80 mil Fiber Reinforced Film & Sheeting
- Geomembrane/Geotextile Composites
- Extrusion Lamination and Coating
- Up to 146" Wide by 48" Diameter Master Rolls
- Textured Surfaces (GeoGrip™ and SurGrip™ Cast)
- Extruded/Cast 7-Layer Gas Impermeable Structures

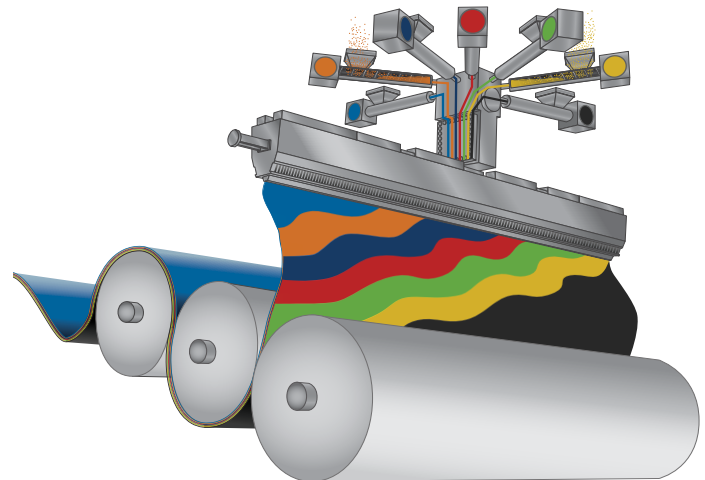

7-LAYER CAST EXTRUSION

## Converting/Fabrication Capabilities:

- Extrusion, Hot Air and Hot Wedge Welding
- Up to 10 Roll High-Speed Seaming
- Custom Fabricated Stepped Panels
- Factory Welded Panels up to 8,000 lbs (up to 4 acres)
- Up to 60' Wide Master Rolls

## Value Added Services:

- Custom Design Build Services
- Certified World-Class Installation Services
- Innovative Modular Concept Systems
- Quality Prefabricated Stepped Panels

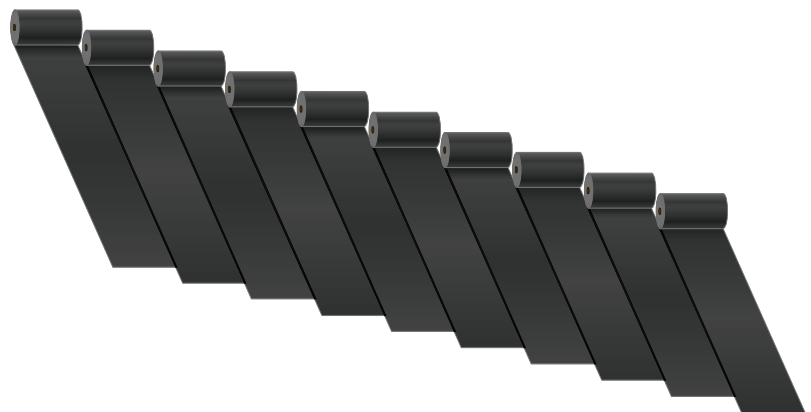

HIGH-SPEED SEAMING (UP TO 10 ROLLS)

**R A V E N**

WE SOLVE GREAT CHALLENGES.

 +1 (800) 635-3456

 +1 (605) 331-0333

 [efdsales@ravenind.com](mailto:efdsales@ravenind.com)

 [www.ravenfd.com](http://www.ravenfd.com)

Scan QR code to  
visit our website.

