

# Wedge-All® Design Information — Concrete



Carbon-Steel Wedge-All Allowable Tension Loads in Normal-Weight Concrete

Mechanical Anchors

Size in. (mm)	Embed. Depth in. (mm)	Critical Edge Dist. in. (mm)	Critical Spacing in. (mm)	Tension Load							Install. Torque ft.-lb. (N-m)
				f' <sub>c</sub> ≥ 2,000 psi (13.8 MPa) Concrete			f' <sub>c</sub> ≥ 3,000 psi (20.7 MPa) Concrete		f' <sub>c</sub> ≥ 4,000 psi (27.6 MPa) Concrete		
				Ultimate lb. (kN)	Std. Dev. lb. (kN)	Allowable lb. (kN)	Allowable lb. (kN)	Ultimate lb. (kN)	Std. Dev. lb. (kN)	Allowable lb. (kN)	
¼ (6.4)	1½ (29)	2½ (64)	1½ (41)	680 (3.0)	167 (0.7)	170 (0.8)	205 (0.9)	960 (4.3)	233 (1.0)	240 (1.1)	8 (10.8)
	2¼ (57)	2½ (64)	3½ (79)	1,920 (8.5)	286 (1.3)	480 (2.1)	530 (2.4)	2,320 (10.3)	105 (0.5)	580 (2.6)	
⅜ (9.5)	1¾ (44)	3¾ (95)	2¾ (60)	1,560 (6.9)	261 (1.2)	390 (1.7)	555 (2.5)	2,880 (12.8)	588 (2.6)	720 (3.2)	30 (40.7)
	2⅝ (67)	3¾ (95)	3⅝ (92)	3,360 (14.9)	464 (2.1)	840 (3.7)	1,100 (4.9)	5,440 (24.2)	553 (2.5)	1,360 (6.0)	
	3⅝ (86)	3¾ (95)	4¾ (121)	3,680 (16.4)	585 (2.6)	920 (4.1)	1,140 (5.1)	5,440 (24.2)	318 (1.4)	1,360 (6.0)	
½ (12.7)	2¼ (57)	5 (127)	3⅝ (79)	3,280 (14.6)	871 (3.9)	820 (3.6)	1,070 (4.8)	5,280 (23.5)	849 (3.8)	1,320 (5.9)	60 (81.3)
	3⅝ (86)	5 (127)	4¾ (121)	6,040 (26.9)	654 (2.9)	1,510 (6.7)	1,985 (8.8)	9,840 (43.8)	1,303 (5.8)	2,460 (10.9)	
	4½ (114)	5 (127)	6¼ (159)	6,960 (31.0)	839 (3.7)	1,740 (7.7)	2,350 (10.5)	11,840 (52.7)	2,462 (11.0)	2,960 (13.2)	
⅝ (15.9)	2¾ (70)	6¼ (159)	3⅝ (98)	4,520 (20.1)	120 (0.5)	1,130 (5.0)	1,640 (7.3)	8,600 (38.3)	729 (3.2)	2,150 (9.6)	90 (122.0)
	4½ (114)	6¼ (159)	6¼ (159)	8,200 (36.5)	612 (2.7)	2,050 (9.1)	2,990 (13.3)	15,720 (69.9)	1,224 (5.4)	3,930 (17.5)	
	5½ (140)	6¼ (159)	7¾ (197)	8,200 (36.5)	639 (2.8)	2,050 (9.1)	2,990 (13.3)	15,720 (69.9)	1,116 (5.0)	3,930 (17.5)	
¾ (19.1)	3⅝ (86)	7½ (191)	4¾ (121)	6,760 (30.1)	1,452 (6.5)	1,690 (7.5)	2,090 (9.3)	9,960 (44.3)	1,324 (5.9)	2,490 (11.1)	150 (203.4)
	5 (127)	7½ (191)	7 (178)	10,040 (44.7)	544 (2.4)	2,510 (11.2)	3,225 (14.3)	15,760 (70.1)	1,550 (6.9)	3,940 (17.5)	
	6¾ (171)	7½ (191)	9½ (241)	10,040 (44.7)	1,588 (7.1)	2,510 (11.2)	3,380 (15.0)	17,000 (75.6)	1,668 (7.4)	4,250 (18.9)	
⅞ (22.2)	3⅝ (98)	8¾ (222)	5⅝ (137)	7,480 (33.3)	821 (3.7)	1,870 (8.3)	2,275 (10.1)	10,720 (47.7)	1,253 (5.6)	2,680 (11.9)	200 (271.2)
	7⅝ (200)	8¾ (222)	11 (279)	17,040 (75.8)	1,566 (7.0)	4,260 (18.9)	4,670 (20.8)	20,320 (90.4)	2,401 (10.7)	5,080 (22.6)	
1 (25.4)	4½ (114)	10 (254)	6¼ (159)	11,550 (51.4)	1,830 (8.1)	2,888 (12.8)	2,891 (12.9)	11,760 (52.3)	1,407 (6.3)	2,940 (13.1)	225 (305.1)
	9 (229)	10 (254)	12⅝ (321)	15,570 (69.3)	2,337 (10.4)	3,893 (17.3)	4,766 (21.2)	22,560 (100.4)	1,209 (5.4)	5,640 (25.1)	
1¼ (31.8)	5⅝ (143)	12½ (318)	7⅝ (200)	11,370 (50.6)	1,010 (4.5)	2,843 (12.6)	3,743 (16.6)	18,570 (82.6)	469 (2.1)	4,643 (20.7)	400 (542.3)
	9½ (241)	12½ (318)	13¼ (337)	15,120 (67.3)	2,438 (10.8)	3,780 (16.8)	6,476 (28.8)	36,690 (163.2)	1,270 (5.6)	9,173 (40.8)	

1. The allowable loads listed are based on a safety factor of 4.0.
2. Refer to allowable load-adjustment factors for edge distance and spacing on pp. 131 and 133.
3. Drill bit diameter used in base material corresponds to nominal anchor diameter.
4. Allowable loads may be linearly interpolated between concrete strengths listed.
5. The minimum concrete thickness is 1½ times the embedment depth.

\* See p. 12 for an explanation of the load table icons.

## Wedge-All® Design Information — Concrete

## Carbon-Steel Wedge-All Allowable Shear Loads in Normal-Weight Concrete



Size in. (mm)	Embed. Depth in. (mm)	Critical Edge Dist. in. (mm)	Critical Spacing in. (mm)	Shear Load					Install. Torque ft.-lb. (N-m)
				$f'_c \geq 2,000$ psi (13.8 MPa) Concrete			$f'_c \geq 3,000$ psi (20.7 MPa) Concrete	$f'_c \geq 4,000$ psi (27.6 MPa) Concrete	
				Ultimate lb. (kN)	Std. Dev. lb. (kN)	Allowable lb. (kN)	Allowable lb. (kN)	Allowable lb. (kN)	
¼ (6.4)	1½ (29)	2½ (64)	1½ (41)	920 (4.1)	47 (0.2)	230 (1.0)	230 (1.0)	230 (1.0)	8 (10.8)
	2¼ (57)	2½ (64)	3½ (79)	—	—	230 (1.0)	230 (1.0)	230 (1.0)	
⅜ (9.5)	1¾ (44)	3¼ (95)	2¾ (60)	2,280 (10.1)	96 (0.4)	570 (2.5)	570 (2.5)	570 (2.5)	30 (40.7)
	2⅝ (67)	3¼ (95)	3⅝ (92)	4,220 (18.8)	384 (1.7)	1,055 (4.7)	1,055 (4.7)	1,055 (4.7)	
	3⅝ (86)	3¼ (95)	4¼ (121)	—	—	1,055 (4.7)	1,055 (4.7)	1,055 (4.7)	
½ (12.7)	2¼ (57)	5 (127)	3½ (79)	6,560 (29.2)	850 (3.8)	1,345 (6.0)	1,485 (6.6)	1,625 (7.2)	60 (81.3)
	3⅝ (86)	5 (127)	4¼ (121)	8,160 (36.3)	880 (3.9)	1,675 (7.5)	1,850 (8.2)	2,020 (9.0)	
	4½ (114)	5 (127)	6¼ (159)	—	—	1,675 (7.5)	1,850 (8.2)	2,020 (9.0)	
⅝ (15.9)	2¾ (70)	6¼ (159)	3¾ (98)	8,720 (38.8)	1,699 (7.6)	1,620 (7.2)	1,900 (8.5)	2,180 (9.7)	90 (122.0)
	4½ (114)	6¼ (159)	6¼ (159)	12,570 (55.9)	396 (1.8)	2,330 (10.4)	2,740 (12.2)	3,145 (14.0)	
	5½ (140)	6¼ (159)	7¼ (197)	—	—	2,330 (10.4)	2,740 (12.2)	3,145 (14.0)	
¾ (19.1)	3⅝ (86)	7½ (191)	4¼ (121)	11,360 (50.5)	792 (3.5)	2,840 (12.6)	2,840 (12.6)	2,840 (12.6)	150 (203.4)
	5 (127)	7½ (191)	7 (178)	18,430 (82.0)	1,921 (8.5)	4,610 (20.5)	4,610 (20.5)	4,610 (20.5)	
	6¼ (171)	7½ (191)	9½ (241)	—	—	4,610 (20.5)	4,610 (20.5)	4,610 (20.5)	
⅞ (22.2)	3⅝ (98)	8¼ (222)	5⅝ (137)	13,760 (61.2)	2,059 (9.2)	3,440 (15.3)	3,440 (15.3)	3,440 (15.3)	200 (271.2)
	7⅝ (200)	8¼ (222)	11 (279)	22,300 (99.2)	477 (2.1)	5,575 (24.8)	5,575 (24.8)	5,575 (24.8)	
1 (25.4)	4½ (114)	10 (254)	6¼ (159)	22,519 (100.2)	1,156 (5.1)	5,730 (25.5)	5,730 (25.5)	5,730 (25.5)	300 (406.7)
	9 (229)	10 (254)	12⅝ (321)	25,380 (112.9)	729 (3.2)	6,345 (28.2)	6,345 (28.2)	6,345 (28.2)	
1¼ (31.8)	5⅝ (143)	12½ (318)	7⅝ (200)	29,320 (130.4)	2,099 (9.3)	7,330 (32.6)	7,330 (32.6)	7,330 (32.6)	400 (542.3)
	9½ (241)	12½ (318)	13¼ (337)	—	—	7,330 (32.6)	7,330 (32.6)	7,330 (32.6)	

1. The allowable loads listed are based on a safety factor of 4.0.
2. Refer to allowable load-adjustment factors for spacing and edge distance on pp. 132, 134 and 135.
3. Drill bit diameter used in base material corresponds to nominal anchor diameter.
4. Allowable loads may be linearly interpolated between concrete strengths listed.
5. The minimum concrete thickness is 1½ times the embedment depth.

\* See p. 12 for an explanation of the load table icons.

# Wedge-All® Design Information — Concrete

Mechanical Anchors

Stainless-Steel Wedge-All Allowable Tension Loads in Normal-Weight Concrete



Size in. (mm)	Embed. Depth in. (mm)	Critical Edge Dist. in. (mm)	Critical Spacing in. (mm)	Allowable Tension Load lb. (kN)			Install. Torque ft.-lb. (N-m)
				$f'_c \geq 2,000$ psi (13.8 MPa) Concrete	$f'_c \geq 3,000$ psi (20.7 MPa) Concrete	$f'_c \geq 4,000$ psi (27.6 MPa) Concrete	
1/4 (6.4)	1 1/8 (29)	2 1/2 (64)	1 5/8 (41)	155 (0.7)	185 (0.8)	215 (1.0)	8 (10.8)
	2 1/4 (57)	2 1/2 (64)	3 1/8 (79)	430 (1.9)	475 (2.1)	520 (2.3)	
3/8 (9.5)	1 3/4 (44)	3 3/4 (95)	2 3/8 (60)	350 (1.6)	500 (2.2)	650 (2.9)	30 (40.7)
	2 5/8 (67)	3 3/4 (95)	3 5/8 (92)	755 (3.4)	990 (4.4)	1,225 (5.4)	
	3 3/8 (86)	3 3/4 (95)	4 3/4 (121)	830 (3.7)	1,025 (4.6)	1,225 (5.4)	
1/2 (12.7)	2 1/4 (57)	5 (127)	3 1/8 (79)	740 (3.3)	965 (4.3)	1,190 (5.3)	60 (81.3)
	3 3/8 (86)	5 (127)	4 3/4 (121)	1,360 (6.0)	1,785 (7.9)	2,215 (9.9)	
	4 1/2 (114)	5 (127)	6 1/4 (159)	1,565 (7.0)	2,115 (9.4)	2,665 (11.9)	
5/8 (15.9)	2 3/4 (70)	6 1/4 (159)	3 7/8 (98)	1,015 (4.5)	1,475 (6.6)	1,935 (8.6)	90 (122.0)
	4 1/2 (114)	6 1/4 (159)	6 1/4 (159)	1,845 (8.2)	2,690 (12.0)	3,535 (15.7)	
	5 1/2 (140)	6 1/4 (159)	7 3/4 (197)	1,845 (8.2)	2,690 (12.0)	3,535 (15.7)	
3/4 (19.1)	3 3/8 (86)	7 1/2 (191)	4 3/4 (121)	1,520 (6.8)	1,880 (8.4)	2,240 (10.0)	150 (203.4)
	5 (127)	7 1/2 (191)	7 (178)	2,260 (10.1)	2,905 (12.9)	3,545 (15.8)	
	6 3/4 (171)	7 1/2 (191)	9 1/2 (241)	2,260 (10.1)	3,040 (13.5)	3,825 (17.0)	
7/8 (22.2)	3 7/8 (98)	8 3/4 (222)	5 3/8 (137)	1,685 (7.5)	2,050 (9.1)	2,410 (10.7)	200 (271.2)
	7 7/8 (200)	8 3/4 (222)	11 (279)	3,835 (17.1)	4,205 (18.7)	4,570 (20.3)	
1 (25.4)	4 1/2 (114)	10 (254)	6 1/4 (159)	2,599 (11.6)	2,621 (11.7)	2,648 (11.8)	225 (305.1)
	9 (229)	10 (254)	12 5/8 (321)	3,503 (15.6)	4,290 (19.1)	5,078 (22.6)	
1 1/4 (31.8)	5 5/8 (143)	12 1/2 (318)	7 7/8 (200)	2,558 (11.4)	3,368 (15.0)	4,178 (18.6)	400 (542.3)
	9 1/2 (241)	12 1/2 (318)	13 1/4 (337)	3,401 (15.1)	5,828 (25.9)	8,254 (36.7)	

1. The allowable loads listed are based on a safety factor of 4.0.
2. Refer to allowable load-adjustment factors for edge distance and spacing on pp. 131 and 133.
3. Drill bit diameter used in base material corresponds to nominal anchor diameter.
4. Allowable loads may be linearly interpolated between concrete strengths listed.
5. The minimum concrete thickness is 1 1/2 times the embedment depth.

\* See p. 12 for an explanation of the load table icons.

## Wedge-All® Design Information — Concrete

## Stainless-Steel Wedge-All Allowable Shear Loads in Normal-Weight Concrete



Size in. (mm)	Embed. Depth in. (mm)	Critical Edge Dist. in. (mm)	Critical Spacing in. (mm)	Allowable Shear Load lb. (kN)			Install. Torque ft.-lb. (N-m)
				$f'_c \geq 2,000$ psi (13.8 MPa) Concrete	$f'_c \geq 3,000$ psi (20.7 MPa) Concrete	$f'_c \geq 4,000$ psi (27.6 MPa) Concrete	
¼ (6.4)	1⅞ (29)	2½ (64)	1⅝ (41)	265 (1.2)	265 (1.2)	265 (1.2)	8 (10.8)
	2¼ (57)	2½ (64)	3⅞ (79)	265 (1.2)	265 (1.2)	265 (1.2)	
⅜ (9.5)	1¾ (44)	3¾ (95)	2⅝ (60)	655 (2.9)	655 (2.9)	655 (2.9)	30 (40.7)
	2⅝ (67)	3¾ (95)	3⅝ (92)	1,215 (5.4)	1,215 (5.4)	1,215 (5.4)	
	3⅝ (86)	3¾ (95)	4¾ (121)	1,215 (5.4)	1,215 (5.4)	1,215 (5.4)	
½ (12.7)	2¼ (57)	5 (127)	3⅞ (79)	1,545 (6.9)	1,710 (7.6)	1,870 (8.3)	60 (81.3)
	3⅝ (86)	5 (127)	4¾ (121)	1,925 (8.6)	2,130 (9.5)	2,325 (10.3)	
	4½ (114)	5 (127)	6¼ (159)	1,925 (8.6)	2,130 (9.5)	2,325 (10.3)	
⅝ (15.9)	2¾ (70)	6¼ (159)	3⅞ (98)	1,865 (8.3)	2,185 (9.7)	2,505 (11.1)	90 (122.0)
	4½ (114)	6¼ (159)	6¼ (159)	2,680 (11.9)	3,150 (14.0)	3,615 (16.1)	
	5½ (140)	6¼ (159)	7¾ (197)	2,680 (11.9)	3,150 (14.0)	3,615 (16.1)	
¾ (19.1)	3⅝ (86)	7½ (191)	4¾ (121)	3,265 (14.5)	3,265 (14.5)	3,265 (14.5)	150 (203.4)
	5 (127)	7½ (191)	7 (178)	5,300 (23.6)	5,300 (23.6)	5,300 (23.6)	
	6¾ (171)	7½ (191)	9½ (241)	5,300 (23.6)	5,300 (23.6)	5,300 (23.6)	
⅞ (22.2)	3⅞ (98)	8¾ (222)	5⅝ (137)	3,955 (17.6)	3,955 (17.6)	3,955 (17.6)	200 (271.2)
	7⅞ (200)	8¾ (222)	11 (279)	6,410 (28.5)	6,410 (28.5)	6,410 (28.5)	
1 (25.4)	4½ (114)	10 (254)	6¼ (159)	6,590 (29.3)	6,590 (29.3)	6,590 (29.3)	300 (406.7)
	9 (229)	10 (254)	12⅝ (321)	7,295 (32.4)	7,295 (32.4)	7,295 (32.4)	
1¼ (31.8)	5⅝ (143)	12½ (318)	7⅞ (200)	8,430 (37.5)	8,430 (37.5)	8,430 (37.5)	400 (542.3)
	9½ (241)	12½ (318)	13¼ (337)	8,430 (37.5)	8,430 (37.5)	8,430 (37.5)	

1. The allowable loads listed are based on a safety factor of 4.0.
2. Refer to allowable load-adjustment factors for spacing and edge distance on pp. 131–132 and 134.
3. Drill bit diameter used in base material corresponds to nominal anchor diameter.
4. Allowable loads may be linearly interpolated between concrete strengths listed.
5. The minimum concrete thickness is 1½ times the embedment depth.

\* See p. 12 for an explanation of the load table icons.

# Wedge-All® Design Information — Concrete and Masonry

## Carbon-Steel Wedge-All Allowable Tension Loads in Sand-Lightweight Concrete over Steel Deck



Size in. (mm)	Embed. Depth in. (mm)	Critical Edge Dist. in. (mm)	Critical Spacing in. (mm)	Tension Load (Install in Concrete)			Tension Load (Install Through Steel Deck)			Install. Torque ft.-lb. (N-m)
				$f'_c \geq 3,000$ psi (20.7 MPa) Concrete			$f'_c \geq 3,000$ psi (20.7 MPa) Concrete			
				Ultimate lb. (kN)	Std. Dev. lb. (kN)	Allow. lb. (kN)	Ultimate lb. (kN)	Std. Dev. lb. (kN)	Allow. lb. (kN)	
1/4 (6.4)	1 1/2 (38)	3 3/8 (86)	2 3/4 (70)	—	—	—	1,440 (6.4)	167 (0.7)	360 (1.6)	—
1/2 (12.7)	2 1/4 (57)	6 3/4 (171)	4 1/8 (105)	3,880 (17.3)	228 (1.0)	970 (4.3)	3,860 (17.2)	564 (2.5)	965 (4.3)	60 (81.3)
5/8 (15.9)	2 3/4 (70)	8 3/8 (213)	5 (127)	5,920 (26.3)	239 (1.1)	1,480 (6.6)	5,220 (23.2)	370 (1.6)	1,305 (5.8)	90 (122.0)
3/4 (19.1)	3 3/8 (>86)	10 (254)	6 1/8 (156)	7,140 (31.8)	537 (2.4)	1,785 (7.9)	6,600 (29.4)	903 (4.0)	1,650 (7.3)	150 (203.4)

See footnotes 1–7 below.

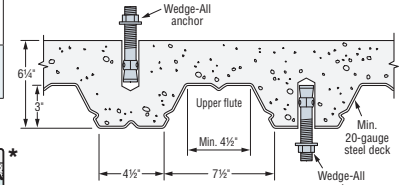

**Lightweight Concrete on Steel Deck**

## Carbon-Steel Wedge-All Allowable Shear Loads in Sand-Lightweight Concrete over Steel Deck



Size in. (mm)	Embed. Depth in. (mm)	Critical Edge Dist. in. (mm)	Critical Spacing in. (mm)	Shear Load (Install in Concrete)			Shear Load (Install Through Steel Deck)			Install. Torque ft.-lb. (N-m)
				$f'_c \geq 3,000$ psi (20.7 MPa) Concrete			$f'_c \geq 3,000$ psi (20.7 MPa) Concrete			
				Ultimate lb. (kN)	Std. Dev. lb. (kN)	Allow. lb. (kN)	Ultimate lb. (kN)	Std. Dev. lb. (kN)	Allow. lb. (kN)	
1/4 (6.4)	1 1/2 (38)	3 3/8 (86)	2 3/4 (70)	—	—	—	1,660 (7.4)	627 (2.8)	415 (1.8)	—
1/2 (12.7)	2 1/4 (57)	6 3/4 (171)	4 1/8 (105)	5,575 (24.8)	377 (1.7)	1,395 (6.2)	7,260 (32.3)	607 (2.7)	1,815 (8.1)	60 (81.3)
5/8 (15.9)	2 3/4 (70)	8 3/8 (213)	5 (127)	8,900 (39.6)	742 (3.3)	2,225 (9.9)	8,560 (38.1)	114 (0.5)	2,140 (9.5)	90 (122.0)
3/4 (19.1)	3 3/8 (86)	10 (254)	6 1/8 (156)	10,400 (46.3)	495 (2.2)	2,600 (11.6)	11,040 (49.1)	321 (1.4)	2,760 (12.3)	150 (203.4)

- The allowable loads listed are based on a safety factor of 4.0.
- Refer to allowable load-adjustment factors for edge distance on p. 135.
- 100% of the allowable load is permitted at critical spacing. Loads at reduced spacing have not been determined.
- Drill bit diameter used in base material corresponds to nominal anchor diameter.
- The minimum concrete thickness is 1 1/2 times the embedment depth.
- Steel deck must be minimum 20 gauge.
- Anchors installed in the bottom flute of the steel deck must have a minimum allowable edge distance of 1 1/2" from the inclined edge of the bottom flute.

## Carbon-Steel Wedge-All Allowable Tension and Shear Loads in Grout-Filled CMU



Size in. (mm)	Embed. Depth in. (mm)	Critical Edge Dist. in. (mm)	Critical End Dist. in. (mm)	Critical Spacing in. (mm)	8" Grout-Filled CMU Allowable Load Based on CMU Strength						Install. Torque ft.-lb. (N-m)
					Tension Load			Shear Load			
					Ultimate lb. (kN)	Std. Dev. lb. (kN)	Allow. lb. (kN)	Ultimate lb. (kN)	Std. Dev. lb. (kN)	Allow. lb. (kN)	
<b>Anchor Installed on the Face of the CMU Wall at Least 1 1/4 inch Away from Head Joint (See Figure)</b>											
3/8 (9.5)	2 5/8 (67)	10 1/2 (267)	10 1/2 (267)	10 1/2 (267)	1,700 (7.6)	129 (0.6)	340 (1.5)	3,360 (14.9)	223 (1.0)	670 (3.0)	30 (40.7)
1/2 (12.7)	3 1/2 (89)	14 (356)	14 (356)	14 (356)	2,120 (9.4)	129 (0.6)	425 (1.9)	5,360 (23.8)	617 (2.7)	1,070 (4.8)	35 (47.4)
5/8 (15.9)	4 3/8 (111)	17 1/2 (445)	17 1/2 (445)	17 1/2 (445)	3,120 (13.9)	342 (1.5)	625 (2.8)	8,180 (36.4)	513 (2.3)	1,635 (7.3)	55 (74.5)
3/4 (19.1)	5 1/4 (133)	21 (533)	21 (533)	21 (533)	4,320 (19.2)	248 (1.1)	865 (3.8)	10,160 (45.2)	801 (3.6)	2,030 (9.0)	120 (162.6)

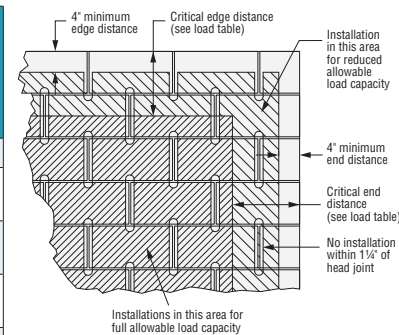

**Shaded area = Placement for Full and Reduced Allowable Load Capacity in Grout-Filled CMU**

- The tabulated allowable loads are based on a safety factor of 5.0 for installations under the IBC and IRC.
- Listed loads may be applied to installations on the face of the CMU wall at least 1 1/4" away from headjoints.
- Values for 8"-wide concrete masonry units (CMU) with a minimum specified compressive strength of masonry,  $f'_m$ , at 28 days is 1,500 psi.
- Embedment depth is measured from the outside face of the concrete masonry unit.
- Drill bit diameter used in base material corresponds to nominal anchor diameter.
- Tension and shear loads for the Wedge-All anchor may be combined using the parabolic interaction equation ( $n = 5/3$ ).
- Refer to allowable load-adjustment factors for edge distance on p. 135.

\* See p. 12 for an explanation of the load table icons.

# Wedge-All® Design Information — Concrete

## Allowable Load-Adjustment Factors for Carbon-Steel and Stainless-Steel Wedge-All Anchors in Normal-Weight Concrete: Edge Distance, Tension and Shear Loads

### How to use these charts:

- The following tables are for reduced edge distance.
- Locate the anchor size to be used for either a tension and/or shear load application.
- Locate the edge distance ( $c_{act}$ ) at which the anchor is to be installed.
- The load adjustment factor ( $f_c$ ) is the intersection of the row and column.
- Multiply the allowable load by the applicable load adjustment factor.
- Reduction factors for multiple edges are multiplied together.

### Edge Distance Tension ( $f_c$ )

Edge Dist. $c_{act}$ (in.)	Size	1/4	3/8	1/2	5/8	3/4	7/8	1	1 1/4
	$c_{cr}$	2 1/2	3 3/4	5	6 1/4	7 1/2	8 3/4	10	12 1/2
	$f_{cmin}$	0.70	0.70	0.70	0.70	0.70	0.70	0.70	0.70
1		0.70							
1 1/2		0.80	0.70						
2		0.90	0.77	0.70					
2 1/2		1.00	0.83	0.75	0.70				
3			0.90	0.80	0.74	0.70			
3 1/2			0.97	0.85	0.78	0.73	0.70		
3 3/4			1.00	0.88	0.80	0.75	0.71		
4				0.90	0.82	0.77	0.73	0.70	
4 1/2				0.95	0.86	0.80	0.76	0.73	
5				1.00	0.90	0.83	0.79	0.75	0.70
5 1/2					0.94	0.87	0.81	0.78	0.72
6					0.98	0.90	0.84	0.80	0.74
6 1/4					1.00	0.92	0.86	0.81	0.75
6 1/2						0.93	0.87	0.83	0.76
7						0.97	0.90	0.85	0.78
7 1/2						1.00	0.93	0.88	0.80
8							0.96	0.90	0.82
8 1/2							0.99	0.93	0.84
8 3/4							1.00	0.94	0.85
10								1.00	0.90
12 1/2									1.00
15									

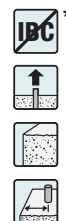

See footnotes below.

### Edge Distance Shear ( $f_c$ ) (Shear Applied Perpendicular to Edge)

Edge Dist. $c_{act}$ (in.)	Size	1/4	3/8	1/2	5/8	3/4	7/8	1	1 1/4
	$c_{cr}$	2 1/2	3 3/4	5	6 1/4	7 1/2	8 3/4	10	12 1/2
	$f_{cmin}$	0.30	0.30	0.30	0.30	0.30	0.30	0.30	0.30
1		0.30							
1 1/2		0.53	0.30						
2		0.77	0.46	0.30					
2 1/2		1.00	0.61	0.42	0.30				
3			0.77	0.53	0.39	0.30			
3 1/2			0.92	0.65	0.49	0.38	0.30		
3 3/4			1.00	0.71	0.53	0.42	0.33		
4				0.77	0.58	0.46	0.37	0.30	
4 1/2				0.88	0.67	0.53	0.43	0.36	
5				1.00	0.77	0.61	0.50	0.42	0.30
5 1/2					0.86	0.69	0.57	0.48	0.35
6					0.95	0.77	0.63	0.53	0.39
6 1/4					1.00	0.81	0.67	0.56	0.42
6 1/2						0.84	0.70	0.59	0.44
7						0.92	0.77	0.65	0.49
7 1/2						1.00	0.83	0.71	0.53
8							0.90	0.77	0.58
8 1/2							0.97	0.83	0.63
8 3/4							1.00	0.85	0.65
10								1.00	0.77
12 1/2									1.00
15									



- $c_{act}$  = actual edge distance at which anchor is installed (inches).
- $c_{cr}$  = critical edge distance for 100% load (inches).
- $c_{min}$  = minimum edge distance for reduced load (inches).
- $f_c$  = adjustment factor for allowable load at actual edge distance.
- $f_{c_{cr}}$  = adjustment factor for allowable load at critical edge distance.  $f_{c_{cr}}$  is always = 1.00.
- $f_{c_{min}}$  = adjustment factor for allowable load at minimum edge distance.
- $f_c = f_{c_{min}} + [(1 - f_{c_{min}}) (c_{act} - c_{min}) / (c_{cr} - c_{min})]$ .

### Load-Adjustment Factors for Reduced Spacing:

Critical spacing is listed in the load tables. No adjustment in load is required when the anchors are spaced at critical spacing. No additional testing has been performed to determine the adjustment factors for spacing dimensions less than those listed in the load tables.

\* See p. 12 for an explanation of the load table icons.

# Wedge-All® Design Information — Concrete

## Allowable Load-Adjustment Factors for Carbon-Steel and Stainless-Steel Wedge-All Anchors in Normal-Weight Concrete: Edge Distance and Shear Load Applied Parallel to Edge

### How to use these charts:

1. The following tables are for reduced edge distance.
2. Locate the anchor size to be used for a shear load application.
3. Locate the edge distance ( $C_{act||}$ ) at which the anchor is to be installed.
4. The load adjustment factor ( $\phi_{c||}$ ) is the intersection of the row and column.
5. Multiply the allowable load by the applicable load adjustment factor.
6. Reduction factors for multiple edges are multiplied together.

Edge Distance Shear ( $f_{c||}$ ) (Shear Applied Parallel to Edge with End Distance  $\geq ED_{min}$ )

Edge Dist. $C_{act  }$ (in.)	Size	1/4	3/8	1/2	5/8	3/4	7/8	1	1 1/4
	E	2 1/4	3 3/8	4 1/2	5 1/2	6 3/4	7 7/8	9	9 1/2
$ED_{min}$	9	13 1/2	18	22	27	31 1/2	36	38	
$C_{crit  }$	2 1/2	3 3/4	5	6 1/4	7 1/2	8 3/4	10	12 1/2	
$C_{min  }$	1	1 1/2	2	2 1/2	3	3 1/2	4	5	
$f_{cmin  }$	1.00	0.93	0.70	0.62	0.62	0.62	0.62	0.62	0.62
1		1.00							
1 1/2		1.00	0.93						
2		1.00	0.95	0.70					
2 1/2		1.00	0.96	0.75	0.62				
3			0.98	0.80	0.67	0.62			
3 1/2			0.99	0.85	0.72	0.66	0.62		
4			1.00	0.90	0.77	0.70	0.66	0.62	
5				1.00	0.87	0.79	0.73	0.68	0.62
6					0.97	0.87	0.80	0.75	0.67
7					1.00	0.96	0.87	0.81	0.72
8						1.00	0.95	0.87	0.77
9							1.00	0.94	0.82
10								1.00	0.87
11									0.92
12									0.97
13									1.00

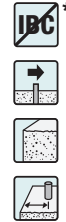

1. Table is not applicable to anchors with  $ED < ED_{min}$ . Factors from this table may not be combined with load-adjustment factors for shear loads applied perpendicular to edge.
2.  $C_{act||}$  = actual edge distance (measured perpendicular to direction of shear load) at which anchor is installed (inches).
3.  $C_{crit||}$  = critical edge distance (measured perpendicular to direction of shear load) for 100% load (inches).
4.  $C_{min||}$  = minimum edge distance (measured perpendicular to direction of shear load) for reduced load (inches).
5.  $ED$  = actual end distance (measured parallel to direction of shear load) at which anchor is installed (inches).
6.  $ED_{min}$  = minimum edge distance (measured parallel to direction of shear load).
7.  $f_{c||}$  = adjustment factor for allowable load at actual edge distance.
8.  $f_{ccrit||}$  = adjustment factor for allowable load at critical edge distance.  $f_{ccrit||}$  is always = 1.00.
9.  $f_{cmin||}$  = adjustment factor for allowable load at minimum edge distance.
10.  $f_{c||} = f_{cmin||} + [(1 - f_{cmin||})(C_{act||} - C_{min||}) / (C_{crit||} - C_{min||})]$ .

\* See p. 12 for an explanation of the load table icons.



# Wedge-All® Design Information — Concrete

## Allowable Load-Adjustment Factors for Carbon-Steel and Stainless-Steel Wedge-All Anchors in Normal-Weight Concrete: Spacing, Tension Loads

### How to use these charts:

1. The following tables are for reduced spacing.
2. Locate the anchor size to be used for a tension load application.
3. Locate the anchor embedment (E) used for a tension load application.
4. Locate the spacing ( $s_{act}$ ) at which the anchor is to be installed.
5. The load adjustment factor ( $f_s$ ) is the intersection of the row and column.
6. Multiply the allowable load by the applicable load adjustment factor.
7. Reduction factors for multiple spacings are multiplied together.

### Spacing Tension ( $f_s$ )

$s_{act}$ (in.)	Di.	¼			⅜			½			¾		
	E	1⅝	2¼	1¾	2⅝	3⅜	2¼	3⅜	4½	2¾	4½	5½	
	$s_{cr}$	1⅝	3⅛	2⅜	3⅝	4¾	3⅛	4¾	6¼	3⅞	6¼	7¾	
	$s_{min}$	⅝	1⅛	⅞	1⅝	1¾	1⅛	1¾	2¼	1⅝	2¼	2¾	
	$f_{smin}$	0.43	0.70	0.43	0.43	0.70	0.43	0.43	0.70	0.43	0.43	0.70	
¾		0.50											
1		0.64		0.48									
1¼		0.79	0.72	0.57			0.47						
1½		0.93	0.76	0.67	0.46		0.54			0.46			
1¾		1.00	0.79	0.76	0.53	0.70	0.61	0.43		0.52			
2			0.83	0.86	0.59	0.73	0.68	0.48		0.57			
2¼			0.87	0.95	0.65	0.75	0.75	0.53	0.70	0.63	0.43		
2½			0.91	1.00	0.72	0.78	0.82	0.57	0.72	0.69	0.47		
2¾			0.94		0.78	0.80	0.89	0.62	0.74	0.74	0.50	0.70	
3			0.98		0.84	0.83	0.96	0.67	0.76	0.80	0.54	0.72	
3½			1.00		0.97	0.88	1.00	0.76	0.79	0.91	0.61	0.75	
4					1.00	0.93		0.86	0.83	1.00	0.68	0.78	
4½						0.98		0.95	0.87		0.75	0.81	
5						1.00		1.00	0.91		0.82	0.84	
6									0.98		0.96	0.90	
7									1.00		1.00	0.96	
8												1.00	

See footnotes below.

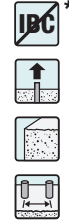

### Spacing Tension ( $f_s$ )

$s_{act}$ (in.)	Di.	¾			7/8		1		1¼	
	E	3⅝	5	6¼	3⅝	7⅞	4½	9	5⅝	9½
	$s_{cr}$	4¾	7	9½	5⅝	11	6¼	12⅝	7⅞	13¼
	$s_{min}$	1¾	2½	3⅝	2	4	2¼	4½	2⅞	4¾
	$f_{smin}$	0.43	0.43	0.70	0.43	0.70	0.43	0.70	0.43	0.70
2		0.48			0.43					
3		0.67	0.49		0.60		0.54		0.46	
4		0.86	0.62	0.73	0.77	0.70	0.68		0.57	
5		1.00	0.75	0.78	0.94	0.74	0.82	0.72	0.68	0.71
6			0.87	0.83	1.00	0.79	0.96	0.76	0.79	0.74
7			1.00	0.88		0.83	1.00	0.79	0.90	0.78
8				0.93		0.87		0.83	1.00	0.81
9				0.98		0.91		0.87		0.85
10				1.00		0.96		0.90		0.89
11						1.00		0.94		0.92
12								0.98		0.96
13								1.00		0.99
14										1.00

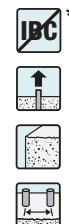

1. E = Embedment depth (inches).
2.  $s_{act}$  = actual spacing distance at which anchors are installed (inches).
3.  $s_{cr}$  = critical spacing distance for 100% load (inches).
4.  $s_{min}$  = minimum spacing distance for reduced load (inches).
5.  $f_s$  = adjustment factor for allowable load at actual spacing distance.
6.  $f_{scr}$  = adjustment factor for allowable load at critical spacing distance.  $f_{scr}$  is always = 1.00.
7.  $f_{smin}$  = adjustment factor for allowable load at minimum spacing distance.
8.  $f_s = f_{smin} + [(1 - f_{smin}) (s_{act} - s_{min}) / (s_{cr} - s_{min})]$ .

\* See p. 12 for an explanation of the load table icons.



# Wedge-All® Design Information — Concrete

## Allowable Load-Adjustment Factors for Carbon-Steel and Stainless-Steel Wedge-All Anchors in Normal-Weight Concrete: Spacing, Shear Loads

### How to use these charts:

1. The following tables are for reduced spacing.
2. Locate the anchor size to be used for a shear load application.
3. Locate the anchor embedment (E) used for a shear load application.
4. Locate the spacing ( $s_{act}$ ) at which the anchor is to be installed.
5. The load adjustment factor ( $f_s$ ) is the intersection of the row and column.
6. Multiply the allowable load by the applicable load adjustment factor.
7. Reduction factors for multiple spacings are multiplied together.

### Spacing Shear ( $f_s$ )

$s_{act}$ (in.)	Di.	¼			⅜			½			⅝		
	E	1⅞	2¼	1¾	2⅝	3⅜	2¼	3⅜	4½	2¾	4½	5½	
	$s_{cr}$	1⅞	3⅞	2⅝	3⅝	4¾	3⅞	4¾	6¼	3⅞	6¼	7¾	
	$s_{min}$	⅝	1⅞	⅞	1⅜	1¾	1⅞	1¾	2¼	1⅞	2¼	2¾	
	$f_{smin}$	0.79	0.79	0.79	0.79	0.79	0.79	0.79	0.79	0.79	0.79	0.79	
¾		0.82											
1		0.87		0.81									
1¼		0.92	0.80	0.84			0.80						
1½		0.97	0.83	0.88	0.80		0.83			0.80			
1¾		1.00	0.86	0.91	0.83	0.79	0.86	0.79		0.82			
2			0.88	0.95	0.85	0.81	0.88	0.81		0.84			
2¼			0.91	0.98	0.87	0.83	0.91	0.83	0.79	0.86	0.79		
2½			0.93	1.00	0.90	0.84	0.93	0.84	0.80	0.88	0.80		
2¾			0.96		0.92	0.86	0.96	0.86	0.82	0.91	0.82	0.79	
3			0.99		0.94	0.88	0.99	0.88	0.83	0.93	0.83	0.80	
3½			1.00		0.99	0.91	1.00	0.91	0.86	0.97	0.86	0.82	
4					1.00	0.95		0.95	0.88	1.00	0.88	0.84	
4½						0.98		0.98	0.91		0.91	0.86	
5							1.00	1.00	0.93		0.93	0.88	
6									0.99		0.99	0.93	
7									1.00		1.00	0.97	
8												1.00	

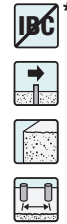

See notes below.

### Spacing Shear ( $f_s$ )

$s_{act}$ (in.)	Di.	¼			⅜		1		1¼	
	E	3⅞	5	6¼	3⅞	7⅞	4½	9	5⅞	9½
	$s_{cr}$	4¾	7	9½	5⅞	11	6¼	12⅝	7⅞	13¼
	$s_{min}$	1¾	2½	3⅞	2	4	2¼	4½	2⅞	4¾
	$f_{smin}$	0.79	0.79	0.79	0.79	0.79	0.79	0.79	0.79	0.79
2		0.81			0.79					
3		0.88	0.81		0.85		0.83		0.80	
4		0.95	0.86	0.81	0.91	0.79	0.88		0.84	
5		1.00	0.91	0.85	0.98	0.82	0.93	0.80	0.88	0.80
6			0.95	0.88	1.00	0.85	0.99	0.83	0.92	0.82
7			1.00	0.91		0.88	1.00	0.85	0.96	0.85
8				0.95		0.91		0.88	1.00	0.87
9				0.98		0.94		0.91		0.90
10				1.00		0.97		0.93		0.92
11						1.00		0.96		0.94
12								0.98		0.97
13								1.00		0.99
14										1.00

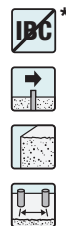

1. E = Embedment depth (inches).
2.  $s_{act}$  = actual spacing distance at which anchors are installed (inches).
3.  $s_{cr}$  = critical spacing distance for 100% load (inches).
4.  $s_{min}$  = minimum spacing distance for reduced load (inches).
5.  $f_s$  = adjustment factor for allowable load at actual spacing distance.
6.  $f_{s_{cr}}$  = adjustment factor for allowable load at critical spacing distance.  $f_{s_{cr}}$  is always = 1.00.
7.  $f_{s_{min}}$  = adjustment factor for allowable load at minimum spacing distance.
8.  $f_s = f_{s_{min}} + [(1 - f_{s_{min}})(s_{act} - s_{min}) / (s_{cr} - s_{min})]$ .

\* See p. 12 for an explanation of the load table icons.

# Wedge-All® Design Information — Concrete and Masonry

## Allowable Load-Adjustment Factors for Carbon-Steel Wedge-All Anchors in Sand-Lightweight Concrete: Edge Distance, Tension and Shear Loads

### How to use these charts:

1. The following tables are for reduced edge distance.
2. Locate the anchor size to be used for either a tension and/or shear load application.
3. Locate the edge distance ( $c_{act}$ ) at which the anchor is to be installed.
4. The load adjustment factor ( $f_c$ ) is the intersection of the row and column.
5. Multiply the allowable load by the applicable load adjustment factor.
6. Reduction factors for multiple edges are multiplied together.

### Edge Distance Tension ( $f_c$ )

Edge Dist. $c_{act}$ (in.)	Size	¼	½	⅝	¾
	$c_{cr}$	3⅞	6¾	8⅞	10
	$c_{min}$	1⅞	2¾	3⅞	4
	$f_{cmin}$	0.70	0.70	0.70	0.70
1⅞		0.70			
1½		0.72			
2		0.79			
2½		0.87			
2¾		0.91	0.70		
3		0.94	0.72		
3⅞		1.00	0.75	0.70	
3½			0.76	0.71	
4			0.79	0.74	0.70
4½			0.83	0.77	0.73
5			0.87	0.80	0.75
5½			0.91	0.83	0.78
6			0.94	0.86	0.80
6½			0.98	0.89	0.83
6¾			1.00	0.90	0.84
7				0.92	0.85
7½				0.95	0.88
8				0.98	0.90
8⅞				1.00	0.92
8½					0.93
9					0.95
9½					0.98
10					1.00

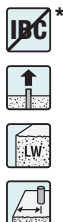

See footnotes below.

### Edge Distance Shear ( $f_c$ ) (Shear Applied Perpendicular to Edge)

Edge Dist. $c_{act}$ (in.)	Size	¼	½	⅝	¾
	$c_{cr}$	3⅞	6¾	8⅞	10
	$c_{min}$	1⅞	2¾	3⅞	4
	$f_{cmin}$	0.30	0.30	0.30	0.30
1⅞		0.30			
1½		0.34			
2		0.52			
2½		0.69			
2¾		0.78	0.30		
3		0.87	0.34		
3⅞		1.00	0.41	0.30	
3½			0.43	0.32	
4			0.52	0.39	0.30
4½			0.61	0.46	0.36
5			0.69	0.53	0.42
5½			0.78	0.60	0.48
6			0.87	0.67	0.53
6½			0.96	0.74	0.59
6¾			1.00	0.77	0.62
7				0.81	0.65
7½				0.88	0.71
8				0.95	0.77
8⅞				1.00	0.81
8½					0.83
9					0.88
9½					0.94
10					1.00



See footnotes below.

## Load Adjustment Factors for Carbon-Steel Wedge-All® Anchors in Face-of-Wall Installation in 8" Grout-Filled CMU: Edge Distance, Tension and Shear Loads

### Edge Distance Tension ( $f_c$ )

Edge Dist. $c_{act}$ (in.)	Size	⅝	½	⅝	¾
	$c_{cr}$	10½	14	17½	21
	$c_{min}$	4	4	4	4
	$f_{cmin}$	1.00	1.00	0.80	0.80
4		1.00	1.00	0.80	0.80
6		1.00	1.00	0.83	0.82
8		1.00	1.00	0.86	0.85
10½		1.00	1.00	0.90	0.88
12			1.00	0.92	0.89
14			1.00	0.95	0.92
16				0.98	0.94
17½				1.00	0.96
21					1.00

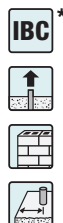

### Load-Adjustment Factors for Reduced Spacing:

Critical spacing is listed in the load tables. No adjustment in load is required when the anchors are spaced at critical spacing. No additional testing has been performed to determine the adjustment factors for spacing dimensions less than those listed in the load tables.

### Edge Distance Shear ( $f_c$ )

Edge Dist. $c_{act}$ (in.)	Size	⅝	½	⅝	¾
	$c_{cr}$	10½	14	17½	21
	$c_{min}$	4	4	4	4
	$f_{cmin}$	0.79	0.52	0.32	0.32
4		0.79	0.52	0.32	0.32
6		0.85	0.62	0.42	0.40
8		0.92	0.71	0.52	0.48
10½		1.00	0.83	0.65	0.58
12			0.90	0.72	0.64
14			1.00	0.82	0.72
16				0.92	0.80
17½				1.00	0.86
21					1.00



1.  $c_{act}$  = actual edge distance at which anchor is installed (inches).
2.  $c_{cr}$  = critical edge distance for 100% load (inches).
3.  $c_{min}$  = minimum edge distance for reduced load (inches).
4.  $f_c$  = adjustment factor for allowable load at actual edge distance.
5.  $f_{c_{cr}}$  = adjustment factor for allowable load at critical edge distance.  $f_{c_{cr}}$  is always = 1.00.
6.  $f_{c_{min}}$  = adjustment factor for allowable load at minimum edge distance.
7.  $f_c = f_{c_{min}} + [(1 - f_{c_{min}})(c_{act} - c_{min}) / (c_{cr} - c_{min})]$ .

\* See p. 12 for an explanation of the load table icons.