

QUALITY LIGHT STEEL FRAMING CONNECTIONS AND MEMBERS

# EXTERIOR WALL MEMBERS & ACCESSORIES

CURTAIN WALL STUDS · JAMBS · HEADERS · SILLS · ACCESSORIES



STEELNETWORK.COM  
1.888.474.4876

Table of Contents

JamStud® Introduction.....1

JamStud® Assembly Comparisons.....2

JamStud® Design Considerations.....3-4

JamStud® Section Properties.....5-6

JamStud® Non Load Bearing Opening Design Example.....7-8

JamStud® Non Load Bearing Opening Allowable Heights.....9-14

JamStud® Load Bearing Opening Design Example.....15-16

JamStud® Load Bearing Opening Allowable Axial Loads.....17-30

JamStud® Non Load Bearing Opening Header/Sill Design Example.....31-32

JamStud® Non Load Bearing Opening Allowable Header Spans.....33-37

JamStud® Header/Sill Solutions.....38

ThermaFast® Continuous Rigid Insulation Framing System Introduction.....39-41

ThermaFast® Corner Angle Section Properties.....42

ThermaFast® J-Track Section Properties.....43

ThermaFast® Z-Track Section Properties.....44

SteelSmart® System Design Software.....45

**600JAM250-43, 50ksi**

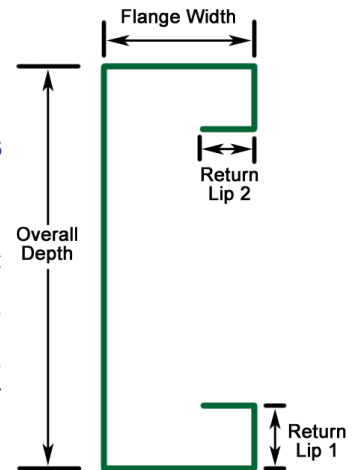

**Background**

JamStud is a revolutionary addition to the light gauge steel stud industry, producing significant economies in both design and installation when compared with conventional “C” Shaped studs. JamStud’s unique configuration delivers increased strength and stiffness, minimizing or eliminating the use of built-up jamb and header sections in curtain wall or load bearing wall assemblies. Available in all common wall stud depths, JamStud streamlines the design and construction process. JamStud’s shape is easily differentiated from the typical c-shape, enabling the selection of the most optimal member sizes to fit project conditions. TSN’s 600JAM™ and 800JAM™ product lines are for 6” and 8” walls. ASI’s SteelSmart® System software includes the complete database of sections to quickly design both JamStud header and jamb members. Visit [www.steelSMARTsystem.com](http://www.steelSMARTsystem.com) for your copy today!

**Benefits That Add Value:**

**Quality**

- Increases load capacity over a standard “C-shaped” stud of the same thickness, reducing overall all materials needed (single “JAM” from double or triple “C-Shape” common)
- Increased stiffness for deflection
- Increased load capacity enables selection of optimal thickness of curtain wall or load bearing wall members

**Value**

- Simplified jamb and header design
- Lighter weight results in shipping efficiencies and easier handling
- Provides a flat surface for attachment of door or window frame, requiring no additional track
- No welding or fastening built-up members together

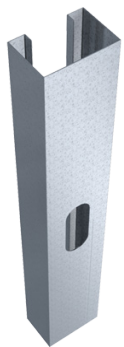

JamStud®

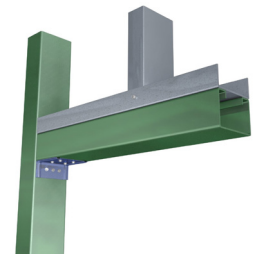

## Assembly Comparison

14' Wall Example: 600JAM350-54mil JamStud compared with (2) 600S162-43 and (1) 600T125-43 members. Refer to Jamb Design Example for design methodology.

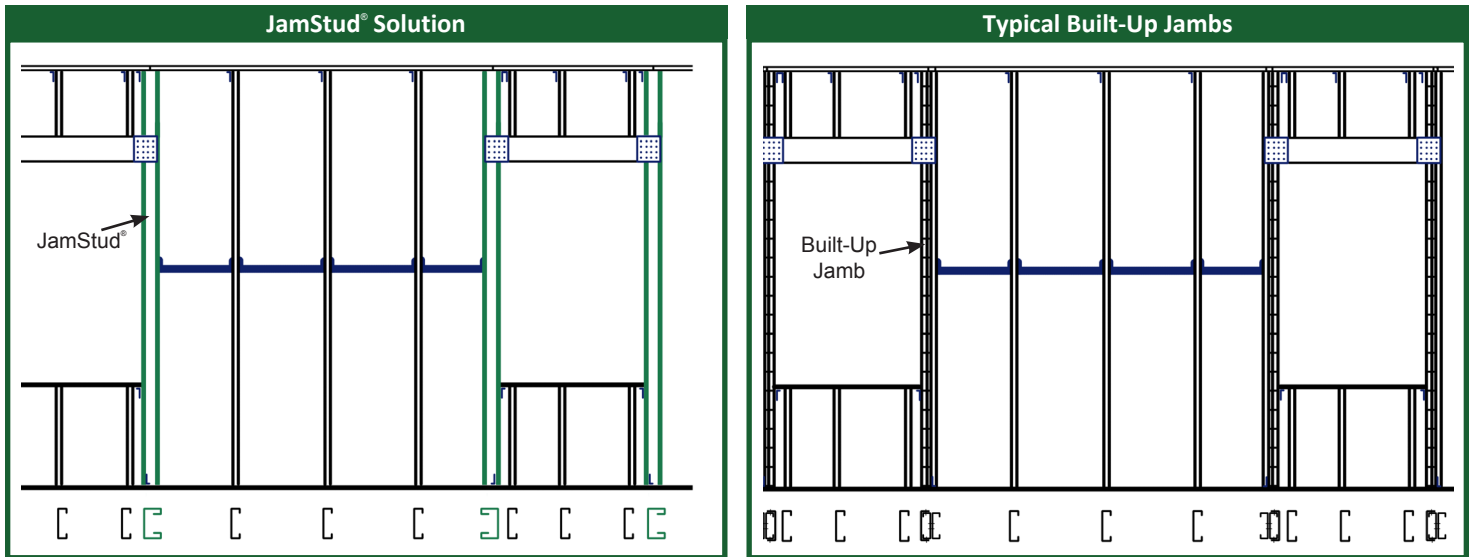

Jamb Member	Weight Per Jamb (lbs)	Qty #10 Screws to Top and Bottom Ends of Stud	Qty #10 Screws to Attach Built-Up Jamb (24" o.c.)	Total Qty #10 Screws at Each Jamb	Qty #10 Screws to Stud & Jamb in Each Two-Opening Assembly Above	Conclusion
600JAM350-54, 50ksi	39.3	2 (To bottom track**)	None	2	8	JamStud is as strong as the built-up column, but with <b>80% of the total weight</b> and <b>26 fewer fasteners to install per jamb</b> . Less materials to handle and fewer fasteners translate to <b>an increase in the rate of production</b> .
(2) 600S162-43 + (1) 5' 600T125-43 section*	50.4	4 (To bottom track**)	24*	28*	112**	The back-to-back jamb members require two #10 screws spaced vertically at 24" on center. <b>Built-up jambs require 14 times the amount of screw fasteners</b> for installation purposes as opposed to the JamStud assembly.

\* A flat surface facing the opening is typically required for attachment of the window frame. A 5' track section has been factored in the properties of the built-up jamb, adding 8 screws for each jamb in the screw total above.

\*\* Connection methods for supporting the header and sill, as well as wall bridging, vertical deflection, and jamb tie-downs are not factored in the number of screws to stud as they are similar in each assembly.

## BuckleBridge® used for Curtain Wall

*"Proven, field tested and a valuable component in the future of light steel framing construction!"*

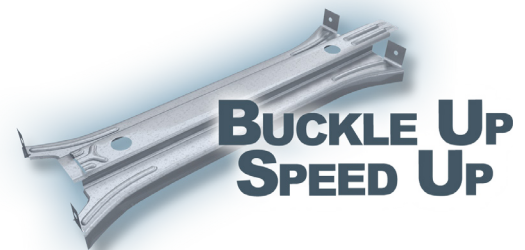

### Saving Benefits

- Fewer Screws Needed!!
- Reduces Install Cost for Walls!
- No Twisting with GWB Installation!
- Added Strength!
- Suitable for 6" & 8" Walls at 16" o.c.!
- Meets All Code Requirements!
- Automatically Aligns Studs!

\* Use (1) #10 screw on alternate sides of the BuckleBridge at 3rd stud (48" o.c.) Use (2) #10 screws at end of wall run.

# Exterior Wall Framing & Accessories

# Design Considerations

## Load Paths

Tracing and verifying load paths through a structure is crucial to protect design liability. Loads need to migrate from the roof, through the wall and floor systems, and terminate in the foundation. For curtain wall systems, JamStud® transfers out-of-plane wind loads from the header and sill to the primary structural system with a single member, simplifying the verification process. Use of a VertiClip® to accommodate vertical deflection will connect the JamStud web to the structure and provide a positive, verifiable connection path. In load bearing wall applications, JamStud transfers vertical gravity loads and out-of-plane wind loads from the header and sill into the floor system.

The optional StiffClip® CL or AL at the base of the wall resists web crippling and delivers an effective load transfer element to the structure. The top three images below illustrate the simplicity in tracing a verifiable load path in a curtain wall opening. The image on the left shows slab-to-slab framing, the middle image is a diagram of bypass (balloon) framing, and the image on the right illustrates the loads at a sill and the bottom end of the JamStud.

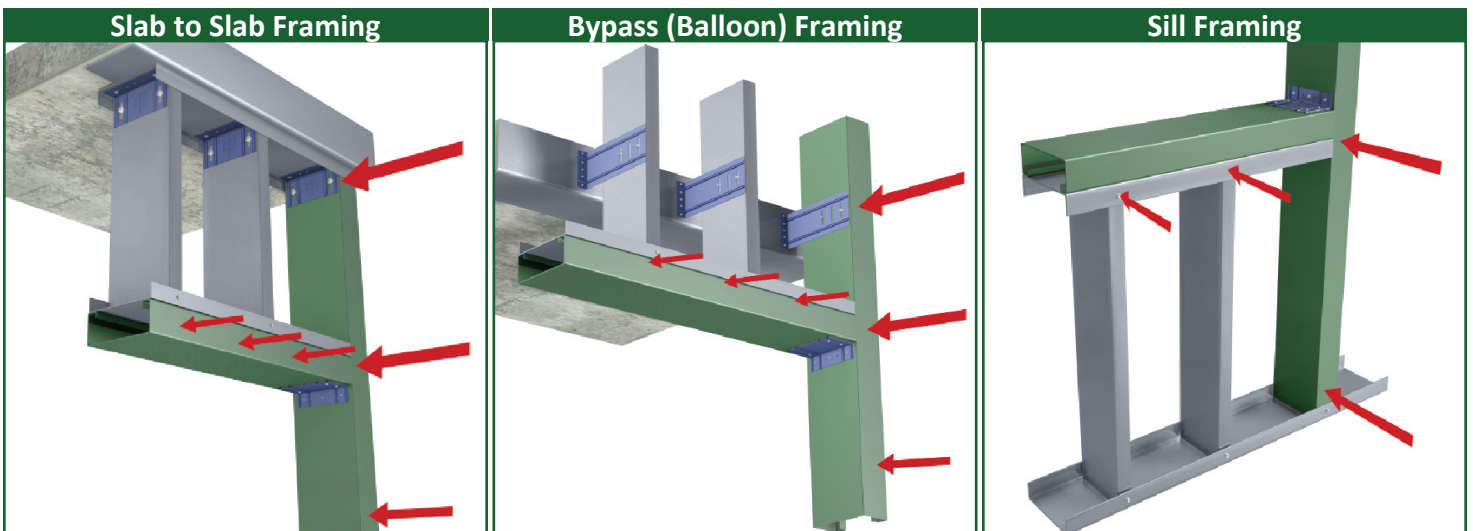
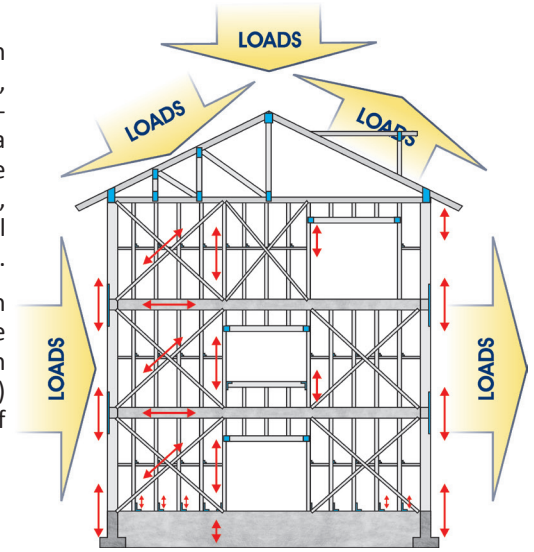

The largest arrows in each diagram indicate end reactions at the structure, with the medium-sized arrows signifying the reactions from the header and sill to JamStud. The smallest arrows point to a uniform wind load. A web stiffener is sometimes required at the top and bottom of the stud and is dependent on the end reactions present. Use of VertiClip SL or StiffClip AL at the top of wall and either StiffClip AL or StiffClip CL at the bottom satisfy the web stiffener requirements (if needed).

## Thermal Value

JamStud provides an improvement in thermal considerations over built-up sections.

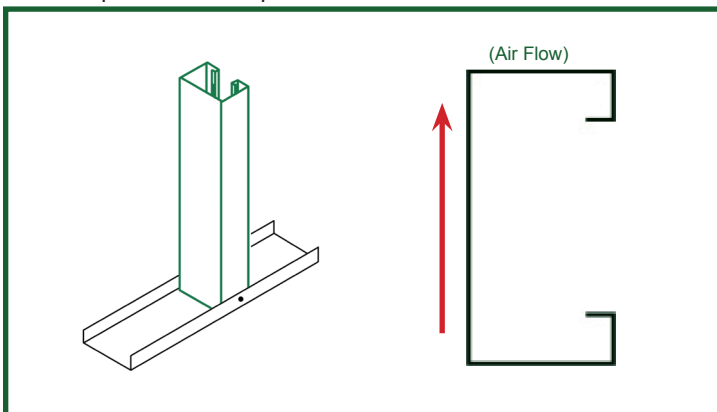

JamStud reduces the amount of materials used in the jamb, reducing the thermal bridge as well as requiring less insulation.

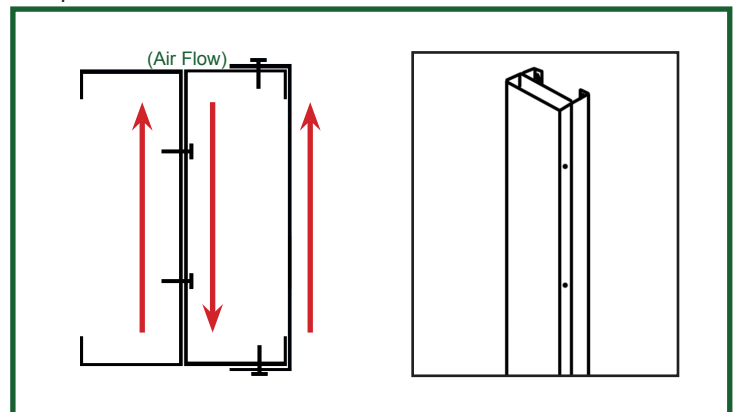

The additional webs in a built-up section increases the area of the thermal bridge. In addition, insulation is required inside the cavity or cavities created in the built-up section.

## Primary Structural Deflection

All structures deflect vertically. To prevent studs and non bearing openings from carrying the weight of the structure and to protect finishes, vertical deflection connections should be incorporated at the earliest possible moment of project design. The load-carrying capacity of a steel stud in bending is reduced significantly when adding an axial force propagated by the bending of a primary beam or slab. VertiClip® was developed to prevent the crushing effect on non-axial-load-bearing wall studs. Non-axial-load-bearing wall studs include exterior curtain wall and interior wall assemblies. When project conditions dictate, lateral drift and vertical deflection may be accommodated through utilization of TSN's DriftClip® and DriftTrak® lines of connectors.

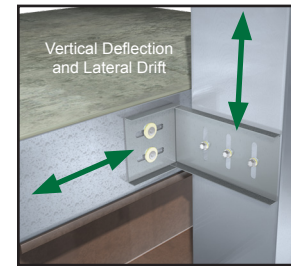
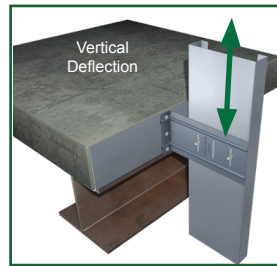
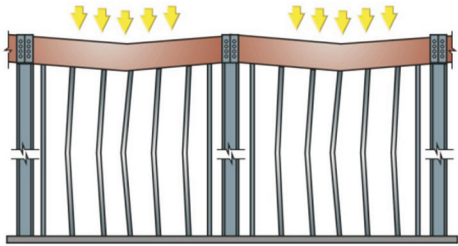

Finished walls frequently experience cracking, buckling, or crushing due to improper isolation of building movement. The movement of the primary building structure is largely accounted for in horizontal member live loading. In addition to live loads, wind, seismic forces, moisture content in materials, and temperature cycles all contribute to movement. The incorporation of vertical deflection connections during the working drawing phase will eliminate the liability of failures and added costs associated with wall system installation.

The VertiClip and DriftClip series of mechanical connectors is a complete solution for all vertical deflection configurations. Substantial effort has been made to standardize construction practices thus ensuring the positive connections of light steel framing components. VertiClip has undergone extensive field and independent laboratory testing to achieve a true slip connection solution that isolates all secondary frame components from loads induced by vertical movement.

\* Each VertiClip and DriftClip is delivered to the installer with step bushings pre-installed for accurate fastener placement. Connection examples shown on this page represent possible application solutions. Connection use is dependant upon project load requirements. More solutions are found in The Steel Network's *Light Steel Framing Connection Catalog*. Contact TSN's Technical Support Team at (888) 474-4876 or support@steelnetwork.com for design recommendations.



An ICC Evaluation Report for VertiClip®, DriftClip®, & DriftTrak® is available. Refer to ICC-ESR-2049 at [www.icc-es.org](http://www.icc-es.org) or at [www.steelnetwork.com](http://www.steelnetwork.com)

## Wall Bridging



- As axial compression and lateral wind loads are applied, wall studs react with weak axis buckling and torsional rotation. To offset these results, a form of bridging is incorporated into the wall system.
- The allowable load capacity of steel studs is dependant upon the presence of securely-attached wall bridging systems at specific vertical intervals (48" or 60" o.c.).
- Bridging is typically addressed with either a channel running through the stud punchouts securely fastened to each stud or by flat straps attached to each stud flange.
- TSN provides the industry's most effective bridging methods with BuckleBridge®, BridgeClip®, BridgeBar®, and BC600/800.
- More bridging information is found in TSN's Light Steel Framing Connections Catalog.

# Exterior Wall Framing & Accessories

## Material Properties

ASTM A1003/A1003M or ASTM A653/A653M, Grade 50 (340), 50ksi (340MPa) minimum yield strength, 65ksi (450 MPa) minimum tensile strength, G-60 (Z180) hot-dipped galvanized coating.

# JamStud® Section Properties

JamStud® Section Dimensions							
Section (All Studs 50ksi)	Overall Depth	Flange Width	Return Lip 1	Return Lip 2	Inside Bend Radius	Design Thickness	Unit Weight (lbs/ft)
	D (in)	B (in)	d1 (in)	d2 (in)	R (in)	t (in)	
350JAM250-43	3.5	2.5	0.6102	0.5	0.105	0.0451	1.553
350JAM250-54	3.5	2.5	0.6332	0.5	0.105	0.0566	1.942
350JAM250-68	3.5	2.5	0.6626	0.5	0.105	0.0713	2.435
350JAM250-97	3.5	2.5	0.7234	0.5	0.105	0.1017	3.438
350JAM350-68	3.5	3.5	0.6626	0.5	0.105	0.0713	2.920
362JAM250-43	3.625	2.5	0.6102	0.5	0.105	0.0451	1.572
362JAM250-54	3.625	2.5	0.6332	0.5	0.105	0.0566	1.966
362JAM250-68	3.625	2.5	0.6626	0.5	0.105	0.0713	2.465
362JAM250-97	3.625	2.5	0.7234	0.5	0.105	0.1017	3.481
362JAM350-68	3.625	3.5	0.6626	0.5	0.105	0.0713	2.950
400JAM250-43	4	2.5	0.6102	0.5	0.105	0.0451	1.630
400JAM250-54	4	2.5	0.6332	0.5	0.105	0.0566	2.038
400JAM250-68	4	2.5	0.6626	0.5	0.105	0.0713	2.556
400JAM250-97	4	2.5	0.7234	0.5	0.105	0.1017	3.611
400JAM350-68	4	3.5	0.6626	0.5	0.105	0.0713	3.041
400JAM350-97	4	3.5	0.7234	0.5	0.105	0.1017	4.303
400JAM350-118	4	3.5	0.7684	0.5	0.105	0.1242	5.216
550JAM250-43	5.5	2.5	0.6102	0.5	0.105	0.0451	1.860
550JAM250-54	5.5	2.5	0.6332	0.5	0.105	0.0566	2.327
550JAM250-68	5.5	2.5	0.6626	0.5	0.105	0.0713	2.920
550JAM250-97	5.5	2.5	0.7234	0.5	0.105	0.1017	4.130
550JAM250-118	5.5	2.5	0.7684	0.5	0.105	0.1242	5.005
550JAM350-68	5.5	3.5	0.6626	0.5	0.105	0.0713	3.405
550JAM350-97	5.5	3.5	0.7234	0.5	0.105	0.1017	4.822
550JAM350-118	5.5	3.5	0.7684	0.5	0.105	0.1242	5.849
600JAM250-43	6	2.5	0.6102	0.5	0.105	0.0451	1.937
600JAM250-54	6	2.5	0.6332	0.5	0.105	0.0566	2.424
600JAM250-68	6	2.5	0.6626	0.5	0.105	0.0713	3.041
600JAM250-97	6	2.5	0.7234	0.5	0.105	0.1017	4.303
600JAM250-118	6	2.5	0.7684	0.5	0.105	0.1242	5.216
600JAM350-68	6	3.5	0.6626	0.5	0.105	0.0713	3.527
600JAM350-97	6	3.5	0.7234	0.5	0.105	0.1017	4.995
600JAM350-118	6	3.5	0.7684	0.5	0.105	0.1242	6.060
800JAM250-43	8	2.5	0.6102	0.5	0.105	0.0451	2.244
800JAM250-54	8	2.5	0.6332	0.5	0.105	0.0566	2.809
800JAM250-68	8	2.5	0.6626	0.5	0.105	0.0713	3.527
800JAM250-97	8	2.5	0.7234	0.5	0.105	0.1017	4.995
800JAM250-118	8	2.5	0.7684	0.5	0.105	0.1242	6.060
800JAM350-68	8	3.5	0.6626	0.5	0.105	0.0713	4.012
800JAM350-97	8	3.5	0.7234	0.5	0.105	0.1017	5.688
800JAM350-118	8	3.5	0.7684	0.5	0.105	0.1242	6.904

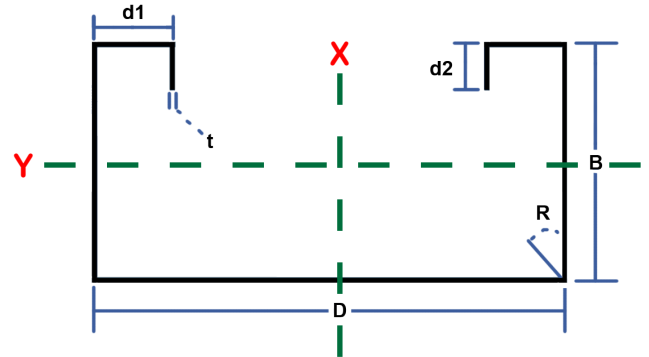

## Important Notes

1. Section properties and capacities are calculated in accordance with AISI S100-16 Spec, "North American Specification for the Design of Cold-Formed Steel Structural Members"
2. Tabulated gross properties are based on the full-unreduced cross section of the studs, away from punchouts.
3. Effective properties incorporate the strength increase from the cold-work of forming as applicable per AISI S100-16 Spec, Sec. A3.3.2 (3).
4. Net effective section properties are calculated at a cross section through the punchout.
5. Allowable moment about x-axis is the lesser of  $M_{al}$  and  $M_{ad}$  at solid section, and the lesser of  $M_{al(net)}$  and  $M_{ad(net)}$  at net section. Stud distortional buckling is based on an assumed  $k_{\phi} = 0$ .
6. For deflection calculations, use the effective moment of inertia.
7. The effective moment of inertia for deflection is calculated at a stress which results in a section modulus such that the stress times the section modulus at that stress is equal to the allowable moment. AISI S100-16 Procedure I for Serviceability Determination has been used.

Section (All 50 ksi)	Gross Properties (for Un-punched Sections)													Effective Properties 50 ksi ("net" = Punched Sections)													Effective Properties if limited to 33 ksi Strength				
	Area	I <sub>x</sub>	S <sub>x</sub>	R <sub>x</sub>	I <sub>y</sub>	R <sub>y</sub>	Jx10 <sup>3</sup>	C <sub>w</sub>	R <sub>o</sub>	m	X <sub>o</sub>	β	I <sub>xe</sub>	S <sub>xe</sub>	S <sub>xe(net)</sub>	M <sub>al</sub>	M <sub>al(net)</sub>	M <sub>ad</sub>	M <sub>ad(net)</sub>	V <sub>a</sub>	V <sub>a(net)</sub>	I <sub>ye</sub> <sup>1</sup>	M <sub>yal</sub> <sup>1</sup>	M <sub>yad</sub> <sup>1</sup>	I <sub>ye</sub> <sup>2</sup>	M <sub>yal</sub> <sup>2</sup>	I <sub>xe</sub>	M <sub>al</sub>	M <sub>al(net)</sub>	M <sub>ad</sub>	M <sub>ad(net)</sub>
	(in <sup>2</sup> )	(in <sup>4</sup> )	(in <sup>3</sup> )	(in)	(in <sup>4</sup> )	(in)	(in <sup>4</sup> )	(in <sup>6</sup> )	(in)	(in)	(in)		(in <sup>4</sup> )	(in <sup>3</sup> )	(in <sup>3</sup> )	(in-k)	(in-k)	(in-k)	(in-k)	(lbs)	(lbs)	(in <sup>4</sup> )	(in-k)	(in-k)	(in <sup>4</sup> )	(in-k)	(in <sup>4</sup> )	(in-k)	(in-k)	(in-k)	(in-k)
350JAM250-43	0.456	0.945	0.540	1.439	0.424	0.964	0.309	1.565	3.017	1.445	-2.471	0.329	0.933	0.447	0.418	13.371	12.505	13.045	12.687	2,141	747	0.424	8.738	8.738	0.383	8.097	0.945	9.764	9.389	9.864	9.628
350JAM250-54	0.571	1.171	0.669	1.432	0.526	0.960	0.609	1.953	3.008	1.442	-2.465	0.329	1.171	0.571	0.545	17.099	16.324	17.616	17.120	3,371	925	0.526	10.864	10.864	0.508	10.390	1.171	12.370	12.069	13.136	12.804
350JAM250-68	0.715	1.450	0.829	1.424	0.653	0.955	1.212	2.443	2.996	1.439	-2.457	0.328	1.450	0.748	0.728	22.400	21.809	23.676	23.014	4,208	900	0.653	13.522	13.522	0.653	13.302	1.450	17.765	17.494	18.039	17.735
350JAM250-97	1.010	1.999	1.142	1.406	0.904	0.946	3.483	3.431	2.972	1.430	-2.441	0.325	1.999	1.125	1.107	37.597	37.006	38.177	37.438	5,886	850	0.904	18.806	18.806	0.904	18.806	1.999	25.603	25.240	25.603	25.237
350JAM350-68	0.858	1.870	1.068	1.476	1.471	1.309	1.454	5.401	3.980	1.965	-3.456	0.246	1.812	0.804	0.774	24.073	23.179	26.651	25.932	4,208	900	1.471	22.321	22.321	1.471	21.873	1.856	17.681	17.250	20.057	19.595
362JAM250-43	0.462	1.024	0.565	1.489	0.430	0.964	0.313	1.656	3.023	1.435	-2.447	0.344	1.011	0.468	0.435	14.012	13.038	13.565	13.194	2,141	802	0.430	8.783	8.663	0.384	8.106	1.024	10.223	9.796	10.265	10.021
362JAM250-54	0.578	1.269	0.700	1.482	0.533	0.961	0.617	2.066	3.014	1.432	-2.442	0.344	1.269	0.598	0.569	17.908	17.031	18.335	17.821	3,372	994	0.533	10.921	10.921	0.511	10.406	1.269	12.944	12.598	13.687	13.369
362JAM250-68	0.724	1.573	0.868	1.474	0.662	0.956	1.227	2.583	3.002	1.428	-2.434	0.342	1.573	0.783	0.761	23.449	22.775	24.670	23.982	4,375	1,007	0.662	13.593	13.593	0.662	13.332	1.573	18.596	18.333	18.889	18.574
362JAM250-97	1.023	2.169	1.197	1.456	0.916	0.946	3.527	3.625	2.977	1.420	-2.418	0.340	2.169	1.178	1.161	39.389	38.814	40.011	39.252	6,124	954	0.916	18.908	18.908	0.916	18.908	2.169	26.833	26.483	26.833	26.480
362JAM350-68	0.867	2.023	1.116	1.528	1.491	1.311	1.469	5.715	3.977	1.954	-3.430	0.256	1.961	0.841	0.808	25.186	24.190	27.689	26.946	4,375	1,007	1.491	22.444	22.444	1.491	21.921	2.019	18.481	18.050	20.857	20.377
400JAM250-43	0.479	1.283	0.641	1.637	0.446	0.965	0.325	1.951	3.046	1.404	-2.381	0.389	1.268	0.534	0.489	15.981	14.635	15.133	14.726	2,141	967	0.446	8.908	8.380	0.389	8.130	1.283	11.631	11.014	11.479	11.208
400JAM250-54	0.599	1.591	0.796	1.630	0.554	0.962	0.640	2.432	3.037	1.401	-2.375	0.388	1.591	0.681	0.640	20.397	19.150	20.506	19.938	3,372	1,201	0.554	11.077	11.077	0.520	10.449	1.591	14.708	14.190	15.351	14.995
400JAM250-68	0.751	1.975	0.987	1.622	0.688	0.957	1.273	3.038	3.025	1.398	-2.368	0.387	1.975	0.891	0.858	26.669	25.675	27.679	26.913	4,876	1,360	0.688	13.790	13.790	0.688	13.411	1.975	21.143	19.215	21.490	19.313
400JAM250-97	1.061	2.730	1.365	1.604	0.953	0.948	3.658	4.255	3.000	1.390	-2.352	0.386	2.730	1.343	1.351	44.884	40.448	45.635	40.443	6,839	1,299	0.953	19.189	19.189	0.953	19.189	2.730	30.605	30.288	30.605	30.284
400JAM350-68	0.894	2.525	1.263	1.681	1.547	1.316	1.514	6.736	3.976	1.922	-3.354	0.288	2.447	0.955	0.909	28.602	27.223	30.818	30.002	4,876	1,360	1.547	22.789	22.789	1.530	22.043	2.519	20.930	20.378	23.268	22.736
400JAM350-97	1.265	3.503	1.751	1.664	2.158	1.306	4.360	9.488	3.953	1.915	-3.339	0.286	3.483	1.502	1.473	44.961	44.092	49.104	47.809	6,839	1,299	2.158	31.903	31.903	2.158	31.903	3.503	36.019	35.587	37.965	37.478
400JAM350-118	1.533	4.184	2.092	1.652	2.587	1.299	7.855	11.458	3.936	1.909	-3.328	0.285	4.184	1.980	1.955	59.268	58.533	62.640	61.275	8,235	1,256	2.587	38.361	38.361	2.587	38.361	4.184	44.732	44.265	46.055	45.671
550JAM250-43	0.547	2.667	0.970	2.209	0.503	0.959	0.371	3.497	3.230	1.297	-2.153	0.556	2.650	0.820	0.820	24.561	24.561	21.511	20.968	1,570	1,192	0.503	9.288	6.962	0.400	8.190	2.667	17.716	17.716	16.435	16.062
550JAM250-54	0.684	3.317	1.206	2.202	0.625	0.956	0.730	4.352	3.221	1.294	-2.147	0.556	3.317	1.043	1.043	31.227	31.227	29.377	28.604	3,117	1,875	0.625	11.554	9.763	0.542	10.559	3.317	22.334	22.334	22.187	21.682
550JAM250-68	0.858	4.129	1.501	2.194	0.776	0.951	1.454	5.423	3.208	1.290	-2.139	0.555	4.129	1.357	1.357	40.642	40.642	40.041	38.971	5,352	2,535	0.776	14.391	13.625	0.728	13.608	4.129	32.111	32.111	31.984	31.245
550JAM250-97	1.214	5.747	2.090	2.176	1.077	0.942	4.184	7.559	3.183	1.282	-2.123	0.555	5.747	2.051	2.051	68.578	68.578	68.487	66.650	9,700	3,167	1.077	20.045	20.045	1.077	19.791	5.747	46.849	46.849	46.849	46.616
550JAM250-118	1.471	6.881	2.502	2.163	1.285	0.935	7.538	9.058	3.163	1.275	-2.111	0.555	6.881	2.502	2.502	85.210	85.210	85.210	84.778	11,723	3,100	1.285	24.010	24.010	1.285	24.010	6.881	57.274	57.274	57.274	56.984
550JAM350-68	1.001	5.180	1.883	2.275	1.743	1.320	1.696	12.048	4.054	1.806	-3.084	0.421	4.957	1.450	1.450	43.421	43.421	43.539	42.448	5,352	2,535	1.743	23.876	22.948	1.613	22.354	5.144	31.469	31.469	33.109	32.375
550JAM350-97	1.417	7.228	2.629	2.259	2.434	1.311	4.886	16.898	4.029	1.798	-3.069	0.420	7.160	2.262	2.262	67.718	67.718	70.434	68.637	9,700	3,167	2.434	33.453	33.453	2.434	32.810	7.228	53.935	53.935	56.053	54.824
550JAM350-118	1.719	8.673	3.154	2.246	2.921	1.304	8.809	20.344	4.012	1.792	-3.057	0.419	8.673	2.976	2.976	89.112	89.112	91.138	88.891	11,723	3,100	2.921	40.250	40.250	2.921	40.250	8.673	67.271	67.271	69.422	69.143
600JAM250-43	0.569	3.261	1.087	2.394	0.519	0.955	0.386	4.150	3.317	1.266	-2.088	0.604	3.245	0.919	0.919	27.502	27.502	23.662	23.076	1,432	1,235	0.519	9.385	6.495	0.403	8.203	3.261	19.902	19.902	18.114	17.709
600JAM250-54	0.712	4.058	1.353	2.387	0.644	0.951	0.760	5.163	3.307	1.263	-2.082	0.604	4.058	1.174	1.174	35.140	35.140	32.383	31.545	2,842	1,942	0.644	11.676	9.203	0.546	10.582	4.058	25.073	25.073	24.516	23.962
600JAM250-68	0.894	5.055	1.685	2.378	0.801	0.947	1.514	6.431	3.295	1.259	-2.074	0.604	5.055	1.526	1.526	45.679	45.679	44.254	43.085	5,352	2,882	0.801	14.544	13.002	0.737	13.650	5.055	36.037	36.037	35.425	34.610
600JAM250-97	1.265	7.047	2.349	2.361	1.111	0.937	4.360	8.956	3.269	1.250	-2.058	0.604	7.047	2.305	2.305	77.070	77.070	76.026	73.996	10,653	3,964	1.111	20.261	20.261	1.111	19.891	7.047	52.663	52.663	52.663	52.449
600JAM250-118	1.533	8.447	2.816	2.348	1.327	0.930	7.855	10.726	3.250	1.244	-2.045	0.604	8.447	2.816	2.816	95.893	95.893	95.893	95.389	12,885	3,889	1.327	24.274	24.274	1.327	24.264	8.447	64.455	64.455	64.455	64.189
600JAM350-68	1.036	6.309	2.103	2.467	1.799	1.318	1.756	14.285	4.106	1.771	-3.006	0.464	6.055	1.628	1.628	48.757	48.757	47.851	46.671	5,352	2,882	1.799	24.160	21.969	1.631	22.421	6.263	35.238	35.238	36.455	35.655
600JAM350-97	1.468	8.816	2.939	2.451	2.513	1.308	5.061	20.020	4.081	1.763	-2.990	0.463	8.730	2.534	2.534	75.856	75.856	77.711	75.750	10,653	3,964	2.513	33.858	33.858	2.512	32.975	8.816	60.297	60.297	61.964	60.610
600JAM350-118	1.781	10.588	3.529	2.438	3.017	1.302	9.127	24.090	4.063	1.757	-2.978</																				

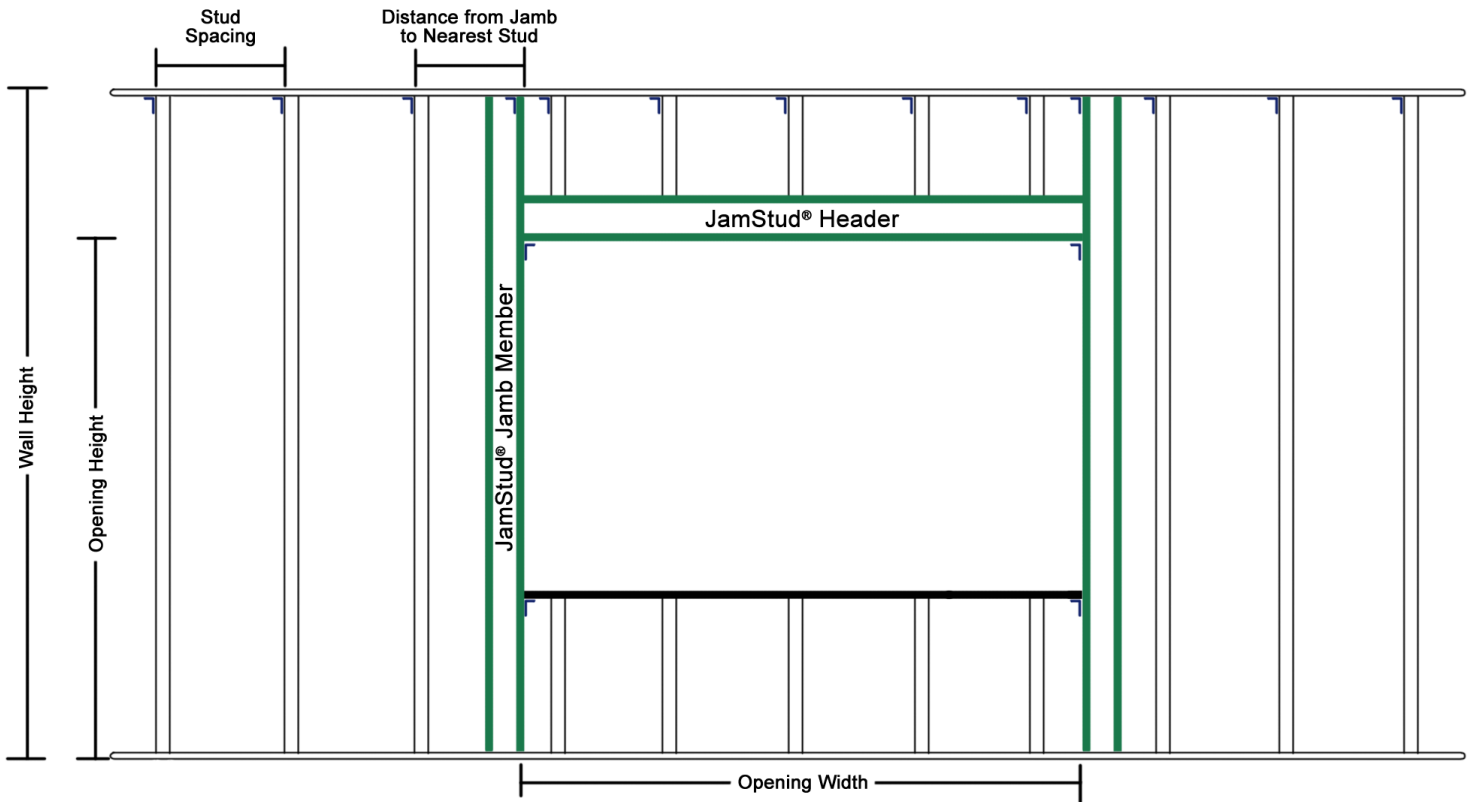

## 1. Basis for Tables

The JamStud Non Load Bearing Opening Allowable Heights tables in this catalog cover the following basic load combination for strength determination using the Allowable Stress Design (ASD) Method (IBC 2018 and ASCE 7-16). Listed wind pressure represents calculated design wind pressure ( $0.6W$  based on IBC 2018).

$$\bullet D + 0.6W_{c\&c} \quad (\text{ASCE 7-16})$$

$W_{c\&c}$  is the component & cladding wind load. The Dead Load (D) acting on the stud is assumed minimum and therefore neglected in the tables.

For deflection determination IBC 2018 Sec. 1604.3 and AISI S240-15 North American Standard for Cold-Formed Steel Structural Framing Sec. B1.1.2. allow for a reduction factor of 0.7 on the component & cladding wind load ( $0.7W_{c\&c}$ ).

The JamStud Allowable Heights tables are based on the following assumptions:

- 4-Way distribution of lateral wind pressure acting on the opening
- Opening height extends from floor level to the bottom surface of the header
- Jamb member supports wind pressure from opening, wind pressure from half distance to adjacent stud, and header reaction

The input for the tables include: the JamStud section, the opening width (ft.), the opening height (ft.), the design wind pressure ( $W_{c\&c}$ , psf), and the specified deflection limit. The output from the tables reflects the allowable JamStud height (ft.-in.) and the controlling design factor, whether it is strength or deflection ("f" denotes strength, "d" denotes deflection). An "\*" denotes critical web crippling at support of jamb. The use of stiffening clips at supports typically eliminates the web crippling condition.

## 2. Design Example

Given:

Wind Pressure ( $0.6W_{c\&c}$ )(ASCE 7-16)	= 30 psf
Wall Width	= 6.0 in.
Wall Height	= 14.0 ft.
Opening Width	= 8.0 ft.
Opening Height	= 10.0 ft.
Stud Spacing	= 16 in. o.c.
Specified Deflection Limit	= L/360
Typical Stud	= 600S162-43

Bridging (Lateral Bracing) is recommended at a vertical spacing of 60" o.c. with both JamStud flanges connected to the sheathing.

## Design Jam:

Go to the JamStud Non Load Bearing Opening Allowable Heights table with 6" stud member, 30 psf wind load, L/360 deflection limit, 8.0 ft. opening width, and 10.0 ft. opening height. Possible JamStud selections from table for 14.0 ft. height are 600JAM250-97 (allowable height = 15' 0") and 600JAM350-68 (allowable height = 14' 6"). The alternative with typical 43mil "cee" studs result in a built-up section comprised of (3) 600S162-43 capped by (2) 600T162-43.

## Conclusion:

The second option, 600JAM350-68, is a lighter section with a lesser thickness. Use 600JAM350-68 (50ksi) (with design thickness = 0.0713" and  $F_y = 50$  ksi). Allow 2 rows of bridging for the wall (including jamb stud) arranged so that the maximum spacing does not exceed 60 in. (5 ft.).

## 3. Extra Design Considerations

Strength determination in the "JamStud Non Load Bearing Opening Allowable Heights" tables includes checks for bending and shear capacity values of the stud and a check for lateral end reaction of the stud for web crippling. If tables indicate critical web crippling (denoted with an "\*"), a clip may be used at the top and bottom ends of stud to eliminate the web crippling condition.

## 4. Design Comparison of Jamb Members

Design Case	Typical Wall Stud	JamStud Solution		Typical Built-Up Jamb	
		Section	Shape	Section**	Shape
$W_{c\&c} = 30$ psf Wall Width = 6.0' Wall Height = 14.0' Opening Width = 6.0' Opening Height = 10.0' Stud Spacing = 16" o.c. Deflection Limit = L/360	600S162-43	Single 600JAM250-68		(2) Studs 600S162-43*, attached at 24" o.c. max. vertically, capped with a closure Track 600T125-43 for window frame attachment	
$W_{c\&c} = 20$ psf Wall Width = 3.625' Wall Height = 10.0' Opening Width = 8.0' Opening Height = 8.0' Stud Spacing = 16" o.c. Deflection Limit = L/600	362S162-43	Built-Up 362JAM350-68 + 362T200-68		(3) Studs 362S162-43 + (1) middle Track 362T125-43, attached at 24" o.c. max. vertically, capped with a closure Track 362T125-43 for window frame attachment	
$W_{c\&c} = 35$ psf Wall Width = 8.0' Wall Height = 16.0' Opening Width = 4.0' Opening Height = 10.0' Stud Spacing = 24" o.c. Deflection Limit = L/360	800S162-54	Single 800JAM250-54		(2) Studs 800S162-54, attached at 24" o.c. max. vertically, capped with a closure Track 800T125-43 for window frame attachment	
$W_{c\&c} = 28$ psf Wall Width = 6.0' Wall Height = 16.0' Opening Width = 12.0' Opening Height = 12.0' Stud Spacing = 16" o.c. Deflection Limit = L/360	600S162-54	Double 600JAM350-68 attached at 24" o.c. max. vertically, capped with a closure Track 600T125-43 for window frame attachment		(4) Studs 600S162-54 + (2) middle Tracks 600T125-54, attached at 24" o.c. max. vertically, capped with a closure Track 600T125-43 for window frame attachment	

\* Web crippling at ends of stud is not satisfied per AISI S100-16 North American Specification for the Design of Cold-Formed Steel Structural Members, Sec. G5. Use VertiClip SL and StiffClip CL at top and bottom ends of stud, respectively, to eliminate web crippling.

\*\* Closure track for window frame attachment was not considered as part of the design cross-section as it does not extend to full height of jamb stud. However, it is up to the EOR to count this track when checking deflection at mid height of jamb stud.



# Exterior Wall Framing & Accessories JamStud® Non Load Bearing Opening Allowable Heights

Refer to Important Table Notes on Page 9

Section	Opening Width (ft)	Opening Height (ft)	Wind Pressure (PSF) And Deflection Limits																											
			5 psf			15 psf			20 psf			25 psf			30 psf			35 psf			40 psf			45 psf			50 psf			
			L/120	L/240	L/360	L/240	L/360	L/600	L/240	L/360	L/600	L/240	L/360	L/600	L/240	L/360	L/600	L/240	L/360	L/600	L/240	L/360	L/600	L/240	L/360	L/600	L/240	L/360	L/600	
400JAM250-43, 50ksi	4	6	27'2" d	20'6" d	17'5" d	15'3" d	13'1" d	10'10" d	13'8" f	11'9" d	9'10" d	12'1" f	10'10" d	9'1" d	11'1" f	10'2" d	8'7" d	10'4" f	9'8" d	8'2" d	9'8" f	9'3" d	7'9" d	9'2" f	8'10" d	7'6" d	8'9" f	8'7" d	7'3" d	
		8	25'6" d	19'5" d	16'7" d	14'8" d	12'8" d	10'7" d	13'2" d	11'5" d	9'7" d	12'1" f	10'7" d	8'11" d	11'0" f	10'0" d	8'5" d	10'2" f	9'6" d	8'0" d	9'6" f	9'1" d		9'0" f	8'8" d		8'6" f	8'5" d		
		10	22'9" d	17'4" d	14'11" d	13'3" d	11'7" d	9'10" d	11'11" f	10'7" d	9'0" d	10'9" f	9'10" d	8'5" d	9'11" f	9'4" d	8'0" d	9'3" f	8'11" d		8'8" f	8'7" d		8'3" f	8'3" f					
	6	8	20'9" d	15'11" d	13'10" d	12'4" f	10'11" d	9'5" d	11'0" f	10'1" d	8'9" d	10'0" f	9'5" d	8'3" d	9'4" f	9'0" d		8'9" f	8'8" d		8'4" f	8'4" f		8'0" f	8'0" f					
		10	20'0" d	15'8" d	13'9" d	12'5" d	11'0" d		11'0" f	10'2" d		10'1" f																		
		12	19'8" d	15'8" d	13'9" d	12'5" d																								
	8	8	18'10" f	15'0" d	13'1" d	11'6" f	10'6" d	9'3" d	10'5" f	9'9" d	8'8" d	9'8" f	9'3" d	8'3" d	9'1" f	8'10" d		8'8" f	8'6" d		8'3" f	8'3" f		8'0" f	8'0" f					
		10	18'7" f	14'11" d	13'3" d	11'11" f	10'10" d		10'8" f	10'1" d																				
		12	18'7" d	15'0" d	13'4" d	12'0" f																								
	400JAM250-54, 50ksi	4	6	29'7" d	22'4" d	19'0" d	16'7" d	14'2" d	11'9" d	14'10" d	12'9" d	10'7" d	13'7" d	11'9" d	9'9" d	12'8" f	11'0" d	9'2" d	11'8" f	10'5" d	8'9" d	10'11" f	9'11" d	8'4" d	10'5" f	9'6" d	8'0" d	9'11" f	9'2" d	7'9" d
			8	27'10" d	21'1" d	18'0" d	15'10" d	13'8" d	11'5" d	14'3" d	12'4" d	10'4" d	13'2" d	11'5" d	9'7" d	12'4" d	10'9" d	9'0" d	11'8" f	10'2" d	8'7" d	10'11" f	9'9" d	8'2" d	10'3" f	9'4" d		9'9" f	9'0" d	
			10	23'8" d	18'3" d	15'10" d	14'2" d	12'5" d	10'6" d	12'10" d	11'4" d	9'8" d	12'0" d	10'6" d	9'0" d	11'2" f	9'11" d	8'6" d	10'5" f	9'6" d	8'2" d	9'10" f	9'1" d				9'4" f	8'10" d		8'10" f
6		8	22'8" d	17'3" d	14'11" d	13'3" d	11'8" d	10'0" d	12'1" d	10'8" d	9'3" d	11'2" f	10'0" d	8'9" d	10'5" f	9'6" d	8'4" d	9'9" f	9'2" d	8'0" d	9'3" f	8'10" d		8'10" f	8'7" d		8'6" f	8'4" d		
		10	21'8" d	16'11" d	14'9" d	13'3" d	11'9" d	10'1" d	12'2" d	10'9" d		11'3" f	10'1" d		10'5" f															
		12	21'3" d	16'9" d	14'9" d	13'3" d			12'2" d																					
8		8	21'0" d	16'2" d	14'1" d	12'7" d	11'2" d	9'9" d	11'6" f	10'4" d	9'1" d	10'7" f	9'9" d	8'7" d	10'0" f	9'4" d	8'3" d	9'5" f	9'0" d	8'0" d	9'0" f	8'8" d		8'8" f	8'6" d		8'5" f	8'3" d		
		10	20'4" d	16'0" d	14'1" d	12'9" d	11'5" d	10'0" d	11'9" d	10'7" d		10'11" f	10'0" d		10'2" f															
		12	20'0" d	16'0" d	14'2" d	12'10" d																								
400JAM250-68, 50ksi		4	6	32'4" d	24'5" d	20'9" d	18'1" d	15'5" d	12'8" d	16'2" d	13'10" d	11'5" d	14'10" d	12'8" d	10'6" d	13'10" d	11'10" d	9'11" d	13'0" d	11'3" d	9'5" d	12'5" d	10'8" d	9'0" d	11'10" d	10'3" d	8'7" d	11'4" f	9'11" d	8'4" d
			8	30'4" d	23'0" d	19'7" d	17'2" d	14'9" d	12'4" d	15'5" d	13'4" d	11'2" d	14'3" d	12'4" d	10'4" d	13'4" d	11'7" d	9'8" d	12'7" d	10'11" d	9'3" d	12'0" d	10'6" d	8'10" d	11'7" d	10'1" d	8'6" d	11'2" d	9'8" d	8'2" d
			10	27'1" d	20'5" d	17'6" d	15'5" d	13'4" d	11'3" d	13'11" d	12'2" d	10'4" d	12'11" d	11'3" d	9'7" d	12'2" d	10'8" d	9'1" d	11'6" d	10'2" d	8'8" d	11'1" d	9'9" d	8'4" d	10'7" f	9'5" d	8'1" d	10'1" f	9'1" d	
	6	8	24'9" d	18'9" d	16'1" d	14'3" d	12'6" d	10'8" d	13'0" d	11'5" d	9'10" d	12'1" d	10'8" d	9'3" d	11'5" d	10'2" d	8'10" d	10'11" d	9'8" d	8'6" d	10'5" f	9'4" d	8'2" d	9'11" f	9'1" d		9'6" f	8'10" d		
		10	23'7" d	18'3" d	15'10" d	14'2" d	12'6" d	10'9" d	13'0" d	11'6" d		12'1" d	10'9" d		11'6" d	10'3" d		11'0" d			10'5" f									
		12	23'0" d	18'0" d	15'9" d	14'2" d	12'6" d		13'0" d			12'2" d																		
	8	8	23'0" d	17'6" d	15'1" d	13'6" d	11'11" d	10'4" d	12'4" d	10'11" d	9'7" d	11'6" d	10'4" d	9'1" d	10'11" d	9'10" d	8'8" d	10'5" f	9'5" d	8'5" d	10'0" f	9'2" d	8'2" d	9'7" f	8'11" d		9'3" f	8'8" d		
		10	22'0" d	17'2" d	15'1" d	13'7" d	12'1" d	10'7" d	12'6" d	11'3" d		11'9" d	10'7" d		11'3" d	10'1" d		10'9" f			10'2" f									
		12	21'6" d	17'1" d	15'1" d	13'8" d	12'2" d		12'7" d																					
	400JAM250-97, 50ksi	4	6	36'10" d	27'10" d	23'7" d	20'7" d	17'6" d	14'4" d	18'4" d	15'8" d	12'10" d	16'10" d	14'4" d	11'10" d	15'8" d	13'5" d	11'1" d	14'9" d	12'7" d	10'6" d	14'0" d	12'0" d	10'0" d	13'5" d	11'6" d	9'7" d	12'10" d	11'1" d	9'3" d
			8	34'8" d	26'2" d	22'3" d	19'6" d	16'8" d	13'10" d	17'5" d	15'0" d	12'6" d	16'0" d	13'10" d	11'6" d	15'0" d	12'11" d	10'10" d	14'2" d	12'3" d	10'3" d	13'6" d	11'8" d	9'10" d	12'11" d	11'3" d	9'5" d	12'6" d	10'10" d	9'1" d
			10	31'0" d	23'3" d	19'10" d	17'5" d	15'0" d	12'7" d	15'8" d	13'6" d	11'5" d	14'5" d	12'7" d	10'7" d	13'6" d	11'10" d	10'0" d	12'10" d	11'3" d	9'7" d	12'3" d	10'9" d	9'2" d	11'10" d	10'4" d	8'10" d	11'5" d	10'0" d	8'7" d
6		8	29'5" d	22'4" d	19'2" d	17'0" d	14'9" d	12'6" d	15'5" d	13'5" d	11'5" d	14'3" d	12'6" d	10'8" d	13'5" d	11'10" d	10'1" d	12'9" d	11'3" d		12'3" d	10'9" d		11'10" d	10'5" d		11'5" d	10'1" d		
		10	28'4" d	21'3" d	18'2" d	16'0" d	13'11" d	11'9" d	14'6" d	12'8" d	10'10" d	13'5" d	11'9" d	10'1" d	12'8" d	11'2" d	9'7" d	12'0" d	10'8" d	9'3" d	11'7" d	10'3" d	8'11" d	11'2" d	9'11" d	8'8" d	10'10" d	9'7" d	8'5" d	
		12	25'11" d	20'2" d	17'7" d	15'9" d	13'10" d		14'4" d	12'8" d		13'5" d			12'8" d			12'1" d	10'9" d		11'7" d	10'4" d		11'3" d	10'0" d		10'11" d			
8		8	26'3" d	19'10" d	17'0" d	15'1" d	13'2" d	11'3" d	13'8" d	12'0" d	10'5" d	12'9" d	11'3" d	9'10" d	12'0" d	10'9" d	9'5" d	11'6" d	10'3" d	9'0" d	11'1" d	9'11" d	8'9" d	10'9" d	9'8" d	8'6" d	10'5" d	9'5" d	8'4" d	
		10	24'11" d	19'2" d	16'8" d	15'0" d	13'3" d	11'6" d	13'9" d	12'3" d	10'8" d	12'10" d	11'6" d	10'1" d	12'3" d	11'0" d		11'9" d	10'7" d		11'4" d	10'2" d		11'0" d			10'8" d			
		12	24'2" d	19'0" d	16'8" d	15'0" d	13'4" d		13'10" d	12'4" d		13'0" d			12'4" d															
400JAM350-68, 50ksi		4	6	35'8" d	27'0" d	22'11" d	20'0" d	17'0" d	13'11" d	17'10" d	15'2" d	12'6" d	16'3" d	13'11" d	11'6" d	15'2" d	13'0" d	10'9" d	14'1" f	12'3" d	10'3" d	13'1" f	11'8" d	9'9" d	12'3" f	11'2" d	9'4" d	11'8" f	10'9" d	9'0" d
			8	33'7" d	25'4" d	21'7" d	18'11" d	16'2" d	13'5" d	16'11" d	14'7" d	12'2" d	15'7" d	13'5" d	11'3" d	14'7" d	12'7" d	10'7" d	13'9" d	11'11" d	10'0" d	13'0" f	11'5" d	9'7" d	12'3" f	10'11" d	9'2" d	11'8" f	10'7" d	8'11" d
			10	30'0" d	22'7" d	19'3" d	16'11" d	14'7" d	12'3" d	15'2" d	13'2" d	11'2" d	14'0" d	12'3" d	10'4" d	13'1" f	11'6" d	9'10" d	12'3" f	10'11" d	9'4" d	11'6" f	10'6" d	9'0" d	10'11" f	10'1" d	8'8" d	10'5" f	9'10" d	8'5" d
	6	8	28'6" d	21'8" d	18'8" d	16'6" d	14'5" d	12'2" d	15'0" d	13'1" d	11'2" d	13'11" d	12'2" d	10'5" d	13'1" d	11'6" d		12'3" f	10'11" d		11'6" f	10'6" d		10'11" f	10'2" d		10'5" f			
		10	27'5" d	20'8" d	17'8" d	15'7" d	13'6" d	11'6" d	14'1" f	12'4" d	10'7" d	12'10" f	11'6" d	9'11" d	12'0" f	10'11" d	9'5" d	11'3" f	10'5" d	9'0" d	10'8" f	10'0" d	8'9" d	10'2" f	9'8" d	8'5" d	9'9" f	9'5" d	8'3" d	
		12	25'2" d	19'7" d	17'1" d	15'4" d	13'6" d		14'0" d	12'4" d	10'8" d	13'1" d	11'7" d	10'0" d	12'1" f	11'0" d		11'4" f	10'6" d		10'8" f	10'1" d		10'2" f						
	8	8	25'5" d	19'2" d	16'6" d	14'8" f	12'10" d	11'0" d	13'0" f	11'9" d	10'2" d	12'0" f	11'0" d	9'8" d	11'3" f	10'6" d	9'2" d	10'8" f	10'1" d	8'10" d	10'2" f	9'9" d	8'7" d	9'9" f	9'5" d	8'5" d	9'5" f	9'2" d	8'2" d	
		10	24'2" d	18'8" d	16'3" d	14'8" d	13'0" d	11'3" d	13'5" d	12'0" d	10'6" d	12'6" f	11'3" d		11'7" f	10'9" d		10'11" f	10'4" d		10'5" f	10'0" d		10'0" f						
		12	23'6" d	18'6" d	16'3" d	14'8" d	13'1" d		13'																					

Refer to Important Table Notes on Page 9

Section	Opening Width (ft)	Opening Height (ft)	Wind Pressure (PSF) And Deflection Limits																											
			5 psf			15 psf			20 psf			25 psf			30 psf			35 psf			40 psf			45 psf			50 psf			
			L/120	L/240	L/360	L/240	L/360	L/600	L/240	L/360	L/600	L/240	L/360	L/600	L/240	L/360	L/600	L/240	L/360	L/600	L/240	L/360	L/600	L/240	L/360	L/600	L/240	L/360	L/600	
400JAM350-118, 50ksi	4	6	43'8" d	33'1" d	28'1" d	24'6" d	20'9" d	16'11" d	21'10" d	18'6" d	15'2" d	19'11" d	16'11" d	13'11" d	18'6" d	15'9" d	13'0" d	17'5" d	14'10" d	12'3" d	16'6" d	14'1" d	11'8" d	15'9" d	13'6" d	11'2" d	15'2" d	13'0" d	10'9" d	
		8	41'2" d	31'1" d	26'5" d	23'1" d	19'8" d	16'2" d	20'7" d	17'7" d	14'6" d	18'10" d	16'2" d	13'5" d	17'7" d	15'1" d	12'7" d	16'7" d	14'3" d	11'11" d	15'9" d	13'7" d	11'4" d	15'1" d	13'0" d	10'11" d	14'6" d	12'7" d	10'6" d	
	6	8	37'1" d	27'9" d	23'6" d	20'6" d	17'6" d	14'6" d	18'4" d	15'9" d	13'2" d	16'10" d	14'6" d	12'2" d	15'9" d	13'8" d	11'6" d	14'11" d	12'11" d	10'11" d	14'2" d	12'4" d	10'6" d	13'8" d	11'11" d	10'1" d	13'2" d	11'6" d	9'9" d	
		10	35'0" d	26'5" d	22'6" d	19'10" d	17'1" d	14'4" d	17'10" d	15'6" d	13'1" d	16'8" d	14'4" d	12'2" d	15'6" d	13'6" d	11'6" d	14'8" d	12'10" d	10'11" d	14'1" d	12'4" d	10'6" d	13'6" d	11'10" d	10'1" d	13'1" d	11'6" d		
	8	8	33'11" d	25'4" d	21'6" d	18'10" d	16'2" d	13'6" d	16'10" d	14'7" d	12'4" d	15'6" d	13'6" d	11'6" d	14'7" d	12'9" d	10'10" d	13'10" d	12'1" d	10'5" d	13'3" d	11'7" d	10'0" d	12'9" d	11'3" d	9'8" d	12'4" d	10'10" d	9'5" d	
		10	31'11" d	24'1" d	20'8" d	18'3" d	15'11" d	13'6" d	16'6" d	14'6" d	12'4" d	15'4" d	13'6" d	11'7" d	14'6" d	12'9" d	10'11" d	13'9" d	12'2" d	10'6" d	13'2" d	11'8" d	10'1" d	12'9" d	11'3" d		12'4" d	10'11" d		
	10	8	31'6" d	23'6" d	20'0" d	17'7" d	15'2" d	12'10" d	15'10" d	13'9" d	11'9" d	14'7" d	12'10" d	11'0" d	13'9" d	12'1" d	10'6" d	13'1" d	11'7" d	10'1" d	12'7" d	11'2" d	9'9" d	12'1" d	10'9" d	9'5" d	11'9" d	10'6" d	9'2" d	
		10	29'8" d	22'6" d	19'4" d	17'3" d	15'1" d	12'11" d	15'8" d	13'10" d	11'11" d	14'7" d	12'11" d	11'3" d	13'10" d	12'4" d	10'9" d	13'3" d	11'10" d	10'4" d	12'9" d	11'5" d	10'0" d	11'11" d	11'0" d		11'11" d	10'9" d		
		12	28'6" d	22'0" d	19'1" d	17'2" d	15'2" d	13'1" d	15'8" d	13'11" d	12'0" d	14'8" d	13'1" d		13'11" d	12'5" d		13'4" d			12'10" d			12'5" d			12'0" d			
	600JAM250-43, 50ksi	4	6	39'6" d	29'11" d	25'5" d	22'1" f	18'10" d	15'4" d	18'1" f	16'9" d	13'9" d	15'8" f	15'4" d	12'8" d	14'0" f	14'0" f	11'10" d	12'10" f	12'10" f	11'2" d	12'0" f	12'0" f	10'8" d	11'4" f	11'4" f	10'3" d	10'9" f	10'9" f	9'10" d
			8	37'3" d	28'1" d	23'10" d	20'1" f	17'10" d	14'9" d	17'0" f	16'0" d	13'3" d	15'2" f	14'9" d	12'3" d	13'10" f	13'9" d	11'6" d	12'10" f	12'10" f	10'11" d	12'0" f	12'0" f	10'5" d	11'3" f	11'3" f	10'0" d	10'8" f	10'8" f	9'8" d
		6	8	33'5" d	25'0" d	21'3" d	16'9" f	16'0" d	13'4" d	14'6" f	14'5" d	12'1" d	13'2" f	13'2" f	11'3" d	12'2" f	12'2" f	10'7" d	11'4" f	11'4" f	10'1" d	10'8" f	10'8" f	9'8" d	10'1" f	10'1" f	9'4" d	9'8" f	9'8" f	9'1" d
10			31'1" f	23'11" d	20'6" d	16'11" f	15'8" d	13'3" d	14'9" f	14'3" d	12'1" d	13'3" f	13'3" f	11'3" d	12'2" f	12'2" f	10'7" d	11'4" f	11'4" f	10'1" d	10'8" f	10'8" f		10'1" f	10'1" f					
8		8	28'8" f	22'10" d	19'5" d	14'10" f	14'9" d	12'5" d	13'1" f	13'1" f	11'5" d	12'1" f	12'1" f	10'8" d	11'2" f	11'2" f	10'1" d	10'6" f	10'6" f	9'8" d	10'0" f	10'0" f	9'4" d	9'6" f	9'6" f	9'0" d	9'2" f	9'2" f	8'10" d	
		10	26'7" f	21'11" d	18'10" d	15'4" f	14'8" d	12'6" d	13'6" f	13'4" d	11'5" d	12'3" f	12'3" f	10'9" d	11'3" f	11'3" f	10'2" d	10'7" f	10'7" f		10'0" f	10'0" f								
10		8	25'0" f	21'3" d	18'2" d	13'8" f	13'8" f	11'10" d	12'3" f	12'3" f	10'11" d	11'4" f	11'4" f	10'3" d	10'8" f	10'8" f	9'10" d	10'1" f	10'1" f	9'5" d	9'7" f	9'7" f	9'2" d	9'3" f	9'3" f	8'11" d	8'11" f	8'11" f	8'8" d	
		12	23'4" f	20'2" d	17'8" d	14'6" f	14'1" d	12'2" d	12'10" f	12'10" f																				
600JAM250-54, 50ksi		4	6	43'1" d	32'8" d	27'9" d	24'2" d	20'6" d	16'9" d	21'6" d	18'4" d	14'11" d	19'2" f	16'9" d	13'9" d	17'0" f	15'7" d	12'10" d	15'5" f	14'8" d	12'1" d	14'3" f	13'11" d	11'6" d	13'4" f	13'4" f	11'1" d	12'7" f	12'7" f	10'8" d
			8	40'8" d	30'9" d	26'1" d	22'9" d	19'5" d	16'0" d	20'4" f	17'4" d	14'4" d	17'10" f	16'0" d	13'3" d	16'2" f	14'11" d	12'5" d	15'0" f	14'1" d	11'9" d	14'0" f	13'5" d	11'3" d	13'2" f	12'11" d	10'10" d	12'6" f	12'5" d	10'5" d
		6	8	36'7" d	27'5" d	23'2" d	20'0" f	17'4" d	14'5" d	17'0" f	15'7" d	13'0" d	15'2" f	14'5" d	12'1" d	13'11" f	13'6" d	11'5" d	13'1" f	12'10" d	10'10" d	12'4" f	12'3" d	10'5" d	11'8" f	11'8" f	10'0" d	11'1" f	11'1" f	9'8" d
			10	34'7" d	26'1" d	22'3" d	19'7" f	16'11" d	14'3" d	17'1" f	15'4" d	12'11" d	15'5" f	14'3" d	12'1" d	14'2" f	13'5" d	11'4" d	13'2" f	12'9" d	10'10" d	12'4" f	12'2" d	10'5" d	11'8" f	11'8" f	10'0" d	11'1" f	11'1" f	
	8	8	33'6" d	25'0" d	21'2" d	17'5" f	16'0" d	13'4" d	15'1" f	14'5" d	12'2" d	13'7" f	13'4" d	11'4" d	12'8" f	12'7" d	10'9" d	11'11" f	11'11" f	10'4" d	11'4" f	11'4" f	9'11" d	10'9" f	10'9" f	9'7" d	10'4" f	10'4" f	9'4" d	
		10	31'7" d	23'10" d	20'5" d	17'6" f	15'9" d	13'4" d	15'6" f	14'4" d	12'3" d	14'0" f	13'4" d	11'5" d	12'11" f	12'7" d	10'10" d	12'1" f	12'1" f	10'5" d	11'5" f	11'5" f	10'0" d	10'10" f	10'10" f		10'4" f	10'4" f		
	10	8	31'1" d	23'3" d	19'9" d	15'9" f	15'0" d	12'8" d	13'10" f	13'7" d	11'8" d	12'7" f	12'7" f	10'11" d	11'10" f	11'10" f	10'5" d	11'3" f	11'3" f	10'0" d	10'9" f	10'9" f	9'8" d	10'3" f	10'3" f	9'4" d	9'11" f	9'11" f	9'1" d	
		10	28'8" f	22'3" d	19'2" d	16'2" f	14'11" d	12'10" d	14'6" f	13'8" d	11'10" d	13'3" f	12'10" d	11'2" d	12'4" f	12'2" d	10'8" d	11'7" f	11'7" f	10'3" d	11'0" f	11'0" f		10'6" f	10'6" f		10'2" f	10'2" f		
		12	27'7" f	21'9" d	18'11" d	16'7" f	15'0" d	12'11" d	14'7" f	13'9" d		13'4" f	12'11" d		12'4" f	12'3" d														
	600JAM250-68, 50ksi	4	6	47'0" d	35'8" d	30'4" d	26'5" d	22'5" d	18'3" d	23'6" d	20'0" d	16'4" d	21'6" d	18'3" d	14'11" d	20'0" d	17'0" d	13'11" d	18'9" d	16'0" d	13'2" d	17'3" f	15'2" d	12'6" d	16'0" f	14'6" d	12'0" d	15'0" f	13'11" d	11'6" d
			8	44'5" d	33'7" d	28'6" d	24'10" d	21'2" d	17'4" d	22'2" d	18'11" d	15'7" d	20'4" d	17'4" d	14'4" d	18'11" d	16'2" d	13'5" d	17'7" f	15'4" d	12'9" d	16'5" f	14'7" d	12'2" d	15'5" f	13'11" d	11'8" d	14'8" f	13'5" d	11'3" d
		6	8	40'1" d	30'0" d	25'4" d	22'2" d	18'10" d	15'7" d	19'9" d	16'11" d	14'0" d	17'10" f	15'7" d	13'0" d	16'2" f	14'7" d	12'3" d	15'0" f	13'10" d	11'7" d	14'1" f	13'2" d	11'2" d	13'5" f	12'8" d	10'9" d	12'10" f	12'3" d	10'4" d
10			37'11" d	28'6" d	24'3" d	21'3" d	18'4" d	15'4" d	19'1" d	16'6" d	13'11" d	17'8" d	15'4" d	12'11" d	16'5" f	14'5" d	12'2" d	15'3" f	13'8" d	11'7" d	14'4" f	13'1" d	11'2" d	13'6" f	12'7" d	10'9" d	12'10" f	12'2" d	10'5" d	
8		8	36'9" d	27'5" d	23'2" d	20'3" d	17'4" d	14'5" d	17'8" f	15'7" d	13'1" d	15'8" f	14'5" d	12'2" d	14'5" f	13'6" d	11'6" d	13'6" f	12'10" d	11'0" d	12'9" f	12'4" d	10'7" d	12'3" f	11'11" d	10'2" d	11'9" f	11'6" d	9'11" d	
		10	34'7" d	26'0" d	22'2" d	19'7" d	16'11" d	14'4" d	17'8" f	15'5" d	13'1" d	16'1" f	14'4" d	12'3" d	14'10" f	13'6" d	11'7" d	13'11" f	12'10" d	11'1" d	13'1" f	12'4" d	10'8" d	12'5" f	11'11" d	10'3" d	11'10" f	11'7" d	10'0" d	
10		8	33'1" d	25'2" d	21'8" d	19'3" d	16'10" d	14'4" d	17'6" d	15'4" d	13'1" d	16'3" f	14'4" d	12'3" d	14'11" f	13'6" d		13'11" f	12'11" d		13'1" f	12'5" d		12'5" f						
		10	34'2" d	25'5" d	21'6" d	18'8" f	16'3" d	13'7" d	15'11" f	14'8" d	12'5" d	14'4" f	13'7" d	11'7" d	13'3" f	12'10" d	11'0" d	12'6" f	12'3" d	10'7" d	11'11" f	11'9" d	10'2" d	11'6" f	11'4" d	9'11" d	11'1" f	11'0" d	9'8" d	
		12	30'8" d	23'6" d	20'5" d	18'3" d	16'0" d	13'9" d	16'7" d	14'8" d	12'8" d	15'2" f	13'9" d		14'1" f	13'1" d		13'2" f	12'6" d		12'5" f	12'1" d								
600JAM250-97, 50ksi		4	6	53'7" d	40'9" d	34'8" d	30'3" d	25'8" d	20'11" d	26'11" d	22'10" d	18'7" d	24'7" d	20'11" d	17'0" d	22'10" d	19'5" d	15'10" d	21'6" d	18'3" d	14'11" d	20'4" d	17'4" d	14'2" d	19'5" d	16'6" d	13'6" d	18'7" d	15'10" d	13'0" d
			8	50'9" d	38'5" d	32'7" d	28'5" d	24'2" d	19'9" d	25'4" d	21'6" d	17'8" d	23'2" d	19'9" d	16'3" d	21'6" d	18'5" d	15'2" d	20'3" d	17'4" d	14'4" d	19'3" d	16'6" d	13'8" d	18'5" d	15'9" d	13'1" d	17'8" d	15'2" d	12'7" d
		6	8	46'1" d	34'6" d	29'1" d	25'4" d	21'6" d	17'7" d</																					

# Exterior Wall Framing & Accessories JamStud® Non Load Bearing Opening Allowable Heights

Refer to Important Table Notes on Page 9

Opening Width (ft)	Opening Height (ft)	Wind Pressure (PSF) And Deflection Limits																												
		5 psf			15 psf			20 psf			25 psf			30 psf			35 psf			40 psf			45 psf			50 psf				
		L/120	L/240	L/360	L/240	L/360	L/600	L/240	L/360	L/600	L/240	L/360	L/600	L/240	L/360	L/600	L/240	L/360	L/600	L/240	L/360	L/600	L/240	L/360	L/600	L/240	L/360	L/600		
600JAM350-68, 50ksi	4	6	51'3"d	39'0"d	33'2"d	28'11"d	24'7"d	20'0"d	25'9"d	21'0"d	17'10"d	23'6"d	20'0"d	16'3"d	21'10"d	18'7"d	15'2"d	19'11"f	17'5"d	14'3"d	18'2"f	16'7"d	13'7"d	16'10"f	15'10"d	13'0"d	15'9"f	15'2"d	12'6"d	
		8	48'7"d	36'9"d	31'2"d	27'2"d	23'1"d	18'11"d	24'3"d	20'7"d	16'11"d	22'2"d	18'11"d	15'7"d	20'2"f	17'7"d	14'7"d	18'5"f	16'7"d	13'9"d	17'1"f	15'10"d	13'1"d	16'1"f	15'1"d	12'7"d	15'3"f	14'7"d	12'2"d	
		10	44'0"d	32'11"d	27'10"d	24'3"d	20'7"d	16'11"d	21'4"f	18'5"d	15'2"d	18'8"f	16'11"d	14'0"d	16'10"f	15'9"d	13'2"d	15'7"f	14'11"d	12'6"d	14'7"f	14'3"d	12'0"d	13'10"f	13'8"d	11'6"d	13'3"f	13'2"d	11'1"d	
	6	8	41'7"d	31'2"d	26'5"d	23'2"d	19'10"d	16'6"d	20'7"f	17'11"d	15'0"d	18'5"f	16'6"d	13'11"d	17'0"f	15'6"d	13'1"d	15'10"f	14'9"d	12'6"d	14'10"f	14'1"d	11'10"d	14'1"f	13'7"d	11'6"d	13'4"f	13'1"d	11'2"d	
		10	40'5"d	30'1"d	25'5"d	22'0"f	18'10"d	15'7"d	18'6"f	16'11"d	14'1"d	16'4"f	15'7"d	13'1"d	14'11"f	14'7"d	12'4"d	13'11"f	13'10"d	11'9"d	13'2"f	13'2"d	11'3"d	12'7"f	12'7"f	10'11"d	12'1"f	12'1"f	10'7"d	
		12	37'11"d	28'5"d	24'2"d	21'2"f	18'4"d	15'4"d	18'4"f	16'7"d	14'0"d	16'8"f	15'4"d	13'1"d	15'5"f	14'6"d	12'4"d	14'5"f	13'9"d	11'10"d	13'7"f	13'3"d	11'4"d	12'10"f	12'9"d	11'0"d	12'3"f	12'3"f	10'8"d	
		8	37'6"d	27'11"d	23'7"d	19'6"f	17'7"d	14'8"d	16'7"f	15'10"d	13'4"d	14'10"f	14'8"d	12'5"d	13'9"f	13'9"f	11'9"d	12'11"f	12'11"f	11'3"d	12'3"f	12'3"d	10'10"d	11'9"f	11'9"f	10'6"d	11'4"f	11'4"f	10'2"d	
		10	35'1"d	26'5"d	22'6"d	19'2"f	17'3"d	14'8"d	16'10"f	15'8"d	13'5"d	15'5"f	14'8"d	12'7"d	14'5"f	13'10"d	12'0"d	13'6"f	13'3"d	11'6"d	12'10"f	12'9"d	11'1"d	12'3"f	12'3"f	10'9"d	11'9"f	11'9"f	10'6"d	
		12	33'6"d	25'7"d	22'0"d	19'7"f	17'2"d	14'8"d	17'4"f	15'8"d	13'6"d	15'9"f	14'8"d	12'8"d	14'6"f	13'11"d	12'1"d	13'7"f	13'4"d		12'10"f	12'10"f		12'3"f	12'3"f					
	600JAM350-97, 50ksi	4	6	58'5"d	44'6"d	37'11"d	33'1"d	28'11"d	22'10"d	29'6"d	25'0"d	20'4"d	26'11"d	22'10"d	18'7"d	25'0"d	21'3"d	17'4"d	23'6"d	19'11"d	16'3"d	22'3"d	18'11"d	15'5"d	21'3"d	18'0"d	14'9"d	20'4"d	17'4"d	14'2"d
			8	55'6"d	42'1"d	35'8"d	31'2"d	26'5"d	21'6"d	27'9"d	23'6"d	19'3"d	25'4"d	21'6"d	17'8"d	23'6"d	20'1"d	16'6"d	22'2"d	18'11"d	15'7"d	21'0"d	17'11"d	14'10"d	20'1"d	17'2"d	14'2"d	19'3"d	16'6"d	13'8"d
			10	50'7"d	37'10"d	31'11"d	27'9"d	23'6"d	19'2"d	24'8"d	20'11"d	17'2"d	22'7"d	19'2"d	15'10"d	20'11"d	17'11"d	14'10"d	19'9"d	16'10"d	14'0"d	18'9"f	16'1"d	13'5"d	17'6"f	15'5"d	12'10"d	16'7"f	14'10"d	12'5"d
6		8	47'10"d	35'9"d	30'3"d	26'5"d	22'6"d	18'7"d	23'7"d	20'2"d	16'10"d	21'8"d	18'7"d	15'7"d	20'2"d	17'5"d	14'7"d	19'1"d	16'6"d	13'11"d	18'2"d	15'9"d	13'4"d	17'5"d	15'2"d	12'10"d	16'10"f	14'7"d	12'4"d	
		10	46'7"d	34'8"d	29'2"d	25'4"d	21'6"d	17'7"d	22'6"d	19'2"d	15'10"d	20'7"d	17'7"d	14'8"d	19'2"d	16'5"d	13'9"d	17'7"f	15'7"d	13'1"d	16'5"f	14'10"d	12'6"d	15'6"f	14'3"d	12'1"d	14'9"f	13'9"d	11'8"d	
		12	43'9"d	32'8"d	27'8"d	24'2"d	20'8"d	17'2"d	21'7"d	18'7"d	15'7"d	19'11"d	17'2"d	14'6"d	18'7"d	16'2"d	13'8"d	17'7"f	15'4"d	13'1"d	16'9"f	14'8"d	12'6"d	15'1"f	14'2"d	12'1"d	15'3"f	13'9"d	11'9"d	
		8	41'8"d	31'3"d	26'8"d	23'6"d	20'4"d	17'1"d	21'2"d	18'5"d	15'7"d	19'7"d	17'1"d	14'6"d	18'5"d	16'1"d	13'9"d	17'6"d	15'4"d	13'1"d	16'9"d	14'8"d	12'7"d	16'1"f	14'2"d	12'1"d	15'3"f	13'9"d		
		10	43'5"d	32'2"d	27'1"d	23'6"d	20'0"d	16'6"d	20'11"d	17'11"d	14'11"d	19'11"d	16'6"d	13'10"d	17'3"f	15'5"d	13'0"d	15'11"f	14'8"d	12'5"d	14'11"f	14'0"d	11'11"d	14'2"f	13'6"d	11'6"d	13'6"f	13'0"d	11'2"d	
		12	40'8"d	30'4"d	25'8"d	22'6"d	19'4"d	16'3"d	20'3"d	17'6"d	14'10"d	18'8"d	16'3"d	13'10"d	17'5"f	15'4"d	13'2"d	16'4"f	14'7"d	12'7"d	15'6"f	14'0"d	12'1"d	14'10"f	13'7"d	11'9"d	14'3"f	13'2"d	11'5"d	
600JAM350-118, 50ksi		4	6	62'8"d	47'10"d	40'9"d	35'8"d	30'3"d	24'7"d	31'9"d	26'11"d	21'11"d	29'0"d	24'7"d	20'0"d	26'11"d	22'10"d	18'7"d	25'4"d	21'6"d	17'6"d	24'0"d	20'4"d	16'7"d	22'10"d	19'5"d	15'10"d	21'11"d	18'7"d	15'2"d
			8	59'8"d	45'3"d	38'5"d	33'6"d	28'5"d	23'2"d	29'10"d	25'4"d	20'8"d	27'3"d	23'2"d	18'11"d	25'4"d	21'7"d	17'8"d	23'10"d	20'3"d	16'8"d	22'7"d	19'3"d	15'10"d	21'7"d	18'5"d	15'2"d	20'8"d	17'8"d	14'7"d
			10	54'6"d	40'11"d	34'6"d	30'0"d	25'4"d	20'7"d	26'7"d	22'7"d	18'5"d	24'3"d	20'7"d	16'11"d	22'7"d	19'2"d	15'10"d	21'2"d	18'1"d	15'0"d	20'1"d	17'2"d	14'3"d	19'2"d	16'5"d	13'8"d	18'5"d	15'10"d	13'2"d
	6	8	50'5"d	37'6"d	31'7"d	27'5"d	23'2"d	18'11"d	24'4"d	20'7"d	16'11"d	22'2"d	18'11"d	15'7"d	20'7"d	17'7"d	14'8"d	19'5"d	16'8"d	13'11"d	18'5"d	15'10"d	13'3"d	17'7"d	15'2"d	12'9"d	16'10"f	14'8"d	12'4"d	
		10	47'4"d	35'3"d	29'9"d	26'0"d	22'2"d	18'4"d	23'2"d	19'11"d	16'7"d	21'3"d	18'4"d	15'5"d	19'11"d	17'3"d	14'6"d	18'10"d	16'4"d	13'10"d	17'11"d	15'7"d	13'3"d	17'3"d	15'0"d	12'9"d	16'7"d	14'6"d	12'5"d	
		12	45'0"d	33'8"d	28'8"d	25'2"d	21'8"d	18'2"d	22'7"d	19'7"d	16'6"d	20'10"d	18'2"d	15'4"d	19'7"d	17'1"d	14'6"d	18'7"d	16'3"d	13'10"d	17'9"d	15'7"d	13'3"d	17'1"d	15'0"d	12'10"d	16'6"d	14'6"d	12'5"d	
		8	47'0"d	34'10"d	29'3"d	25'5"d	21'6"d	17'8"d	22'7"d	19'2"d	15'10"d	20'7"d	17'8"d	14'8"d	19'2"d	16'6"d	13'10"d	18'1"d	15'7"d	13'2"d	17'1"f	14'11"d	12'7"d	16'1"f	14'4"d	12'2"d	15'3"f	13'10"d	11'9"d	
		10	44'0"d	32'8"d	27'8"d	24'2"d	20'8"d	17'3"d	21'8"d	18'8"d	15'9"d	19'11"d	17'3"d	14'8"d	18'8"d	16'3"d	13'10"d	17'8"d	15'6"d	13'3"d	16'11"d	14'10"d	12'9"d	16'3"d	14'4"d	12'4"d	15'9"f	13'10"d	12'0"d	
		12	41'9"d	31'3"d	26'8"d	23'6"d	20'4"d	17'3"d	21'3"d	18'6"d	15'9"d	19'8"d	17'3"d	14'9"d	18'6"d	16'3"d	13'11"d	17'7"d	15'6"d	13'4"d	16'10"d	14'11"d	12'10"d	16'3"d	14'5"d	12'5"d	15'9"f	13'11"d	12'1"d	
	800JAM250-43, 50ksi	4	6	51'6"d	39'2"d	33'3"d	27'10"f	24'8"d	20'1"d	22'5"f	21'11"d	17'10"d	19'2"f	19'2"f	16'4"d	17'0"f	17'0"f	15'3"d	15'5"f	15'5"f	14'4"d	14'3"f	14'3"f	13'8"d	13'4"f	13'4"f	13'0"d	12'7"f	12'7"f	12'6"d
			8	48'10"d	36'11"d	31'4"d	24'6"f	23'2"f	19'0"d	20'4"f	20'4"f	17'0"d	17'0"d	17'0"d	15'7"d	16'2"f	16'2"f	15'7"d	15'0"f	15'0"f	13'10"d	14'0"f	14'0"f	13'2"d	13'2"f	13'2"f	12'8"d	12'6"f	12'6"f	12'2"d
			10	43'10"f	33'1"d	27'11"d	20'0"f	16'11"d	17'0"f	17'0"f	15'3"d	15'2"f	15'2"f	14'1"d	13'11"f	13'11"f	13'3"d	13'1"f	13'1"f	12'7"d	12'4"f	12'4"f	12'0"d	11'8"f	11'8"f	11'7"d	11'1"f	11'1"f	11'1"f	
6		8	38'9"f	31'4"d	26'7"d	19'6"f	19'6"f	16'7"d	17'1"f	17'1"f	15'0"d	15'5"f	15'5"f	13'11"d	14'2"f	14'2"f	13'2"d	13'2"f	13'2"f	12'6"d	12'4"f	12'4"f	12'0"d	11'8"f	11'8"f	11'7"d	11'1"f	11'1"f	11'1"f	
		10	36'3"f	30'3"d	25'6"d	17'5"f	17'5"f	15'8"d	15'0"f	15'0"f	14'2"d	13'7"f	13'7"f	13'1"d	12'8"f	12'8"f	12'4"d	11'9"f	11'9"f	11'9"f	11'0"f	11'0"f	11'0"f	10'4"f	10'4"f	10'4"f	9'8"f	9'8"f	9'8"f	
		12	32'7"f	28'7"d	24'3"d	17'6"f	17'6"f	15'5"d	15'6"f	15'6"f	14'1"d	14'0"f	14'0"f	13'1"d	12'11"f	12'11"f	12'5"d	12'1"f	12'1"f	11'10"d	11'5"f	11'5"f	11'5"f	10'6"f	10'6"f	10'6"f	10'0"f	10'0"f	10'0"f	
		8	30'10"f	27'6"d	23'7"d	17'10"f	17'10"f	15'5"d	15'7"f	15'7"f	14'1"d	14'1"f	14'1"f	13'2"d	12'11"f	12'11"f	12'5"d	12'1"f	12'1"f											
		10	31'3"f	28'0"d	23'8"d	15'9"f	15'9"f	14'8"d	13'9"f	13'9"f	13'4"d	12'7"f	12'7"f	12'6"d	11'6"f	11'6"f	11'6"f	10'8"f	10'8"f	10'8"f	9'10"f	9'10"f	9'10"f	8'11"f	8'11"f	8'11"f	8'0"f	8'0"f	8'0"f	
		12	28'7"f	26'6"d	22'2"d	16'2"f	16'2"f	14'8"d	14'6"f	14'6"f	13'6"d	13'3"f	13'3"f	12'8"d	12'2"f	12'2"f	12'0"d	11'2"f	11'2"f	11'2"f	10'0"f	10'0"f	10'0"f	10'0"f	10'0"f	10'0"f	10'0"f	10'0"f	10'0"f	
800JAM250-54, 50ksi		4	6	56'1"d	42'9"d	36'4"d	31'9"d	26'11"d	21'11"d	28'3"d	24'0"d	19'6"d	24'1"f	21'11"d	17'10"d	21'1"f	20'4"d	16'7"d	18'11"f	18'11"f	15'8"d	17'4"f	17'4"f	14'10"d	16'1"f	16'1"f	14'2"d	15'1"f	15'1"f	13'7"d
			8	53'3"d	40'4"d	34'3"d	29'10"d	25'4"d	20'8"d	25'0"f	22'7"d	18'6"d	21'7"f	20'8"d	17'0"d	19'4"f	19'3"d	15'10"d	17'8"f	17'8"f	15'0"d	16'5"f	16'5"f	14'3"d	15'6"f	15'6"f	13'8"d	14'8"f	14'8"f	13'2"d
			10	48'5"d	36'3"d	30'7"d	24'6"f	22'7"d	18'5"d	20'5"f	20'1"d	16'6"d	17'11"f	17'11"f	15'3"d	16'3"f	16'3"f	14'3"d	15'0"f	15'0"f	13'6"d	14'2"f	14'2"f	12'11"d	13'5"f	13'5"f	12'5"d	12'10"f	12'10"f	12'0"d
	6	8	45'9"d	34'3"d	29'0"d	23'2"f	21'8"d	17'11"d	19'10"f	19'5"d	16'2"d	17'10"f	17'10"f	15'0"d	16'5"f	16'5"f	14'2"d	15'4"f	15'4"f	13'5"d	14'4"f	14'4"f	12'10"d	13'7"f	13'7"f	12'5"d	12'11"f	12'11"f	12'0"d	
		10	44'7"d	33'2"d	27'11"d	21'0"f	20'7"d	16'11"d	17'9"f	17'9"f	15'3"d	15'9"f	15'9"f	14'1"d	14'5"f															

Refer to Important Table Notes on Page 9

Section	Opening Width (ft)	Opening Height (ft)	Wind Pressure (PSF) And Deflection Limits																											
			5 psf			15 psf			20 psf			25 psf			30 psf			35 psf			40 psf			45 psf			50 psf			
			L/120	L/240	L/360	L/240	L/360	L/600	L/240	L/360	L/600	L/240	L/360	L/600	L/240	L/360	L/600	L/240	L/360	L/600	L/240	L/360	L/600	L/240	L/360	L/600	L/240	L/360	L/600	
800JAM250-97, 50ksi	4	6	69'7" d	53'3" d	45'5" d	39'9" d	33'9" d	27'6" d	35'5" d	30'1" d	24'5" d	32'5" d	27'6" d	22'4" d	30'1" d	25'6" d	20'9" d	28'3" d	24'0" d	19'6" d	26'9" d	22'9" d	18'6" d	25'6" d	21'8" d	17'8" d	24'5" d	20'9" d	16'11" d	
		8	66'5" d	50'6" d	42'11" d	37'5" d	31'9" d	25'10" d	33'4" d	28'3" d	23'0" d	30'5" d	25'10" d	21'1" d	28'3" d	24'0" d	19'7" d	26'7" d	22'7" d	18'6" d	25'2" d	21'5" d	17'7" d	24'0" d	20'5" d	16'9" d	23'0" d	19'7" d	16'2" d	
	6	8	61'0" d	45'9" d	38'8" d	33'7" d	28'4" d	23'0" d	29'9" d	25'2" d	20'6" d	27'2" d	23'0" d	18'9" d	25'2" d	21'4" d	17'6" d	23'8" d	20'1" d	16'6" d	22'5" d	19'1" d	15'9" d	21'3" f	18'3" d	15'1" d	19'11" f	17'6" d	14'6" d	
		10	57'10" d	43'3" d	36'6" d	31'9" d	26'11" d	22'1" d	28'3" d	24'1" d	19'9" d	25'10" d	22'1" d	18'3" d	24'1" d	20'7" d	17'1" d	22'8" d	19'5" d	16'2" d	21'6" d	18'6" d	15'6" d	20'6" f	17'9" d	14'10" d	19'5" f	17'1" d	14'4" d	
	8	8	56'7" d	42'1" d	35'5" d	30'8" d	25'11" d	21'0" d	27'2" d	23'0" d	18'9" d	24'9" d	21'0" d	17'3" d	23'0" d	19'7" d	16'1" d	21'4" f	18'5" d	15'3" d	19'8" f	17'6" d	14'7" d	18'5" f	16'9" d	14'0" d	17'4" f	16'1" d	13'6" d	
		12	53'2" d	39'7" d	33'4" d	29'0" d	24'7" d	20'3" d	25'10" d	22'0" d	18'3" d	23'7" d	20'3" d	16'11" d	22'0" d	18'11" d	15'10" d	20'8" f	17'11" d	15'1" d	19'4" f	17'1" d	14'5" d	18'3" f	16'5" d	13'11" d	17'5" f	15'10" d	13'5" d	
	10	8	52'11" d	39'2" d	32'11" d	28'6" d	24'0" d	19'7" d	25'3" d	21'4" d	17'6" d	23'0" d	19'7" d	16'2" d	20'10" f	18'3" d	15'2" d	19'0" f	17'3" d	14'4" d	17'8" f	16'5" d	13'9" d	16'7" f	15'9" d	13'3" d	15'8" f	15'2" d	12'10" d	
		12	49'6" d	36'8" d	30'11" d	26'11" d	22'11" d	19'0" d	24'0" d	20'7" d	17'2" d	22'0" d	19'0" d	16'0" d	20'3" f	17'10" d	15'1" d	18'9" f	16'11" d	14'4" d	17'8" f	16'2" d	13'10" d	16'9" f	15'7" d	13'4" d	16'1" f	15'1" d	12'11" d	
	800JAM250-118, 50ksi	4	6	74'7" d	57'2" d	48'10" d	42'9" d	36'5" d	29'7" d	38'2" d	32'5" d	26'4" d	34'10" d	29'7" d	24'1" d	32'5" d	27'6" d	22'4" d	30'5" d	25'10" d	21'0" d	28'10" d	24'6" d	19'11" d	27'6" d	23'4" d	19'0" d	26'4" d	22'4" d	18'2" d
			8	71'5" d	54'4" d	46'3" d	40'4" d	34'3" d	27'10" d	35'11" d	30'6" d	24'9" d	32'10" d	27'10" d	22'8" d	30'6" d	25'10" d	21'1" d	28'7" d	24'4" d	19'10" d	27'1" d	23'0" d	18'10" d	25'10" d	22'0" d	18'0" d	24'9" d	21'1" d	17'4" d
		6	8	65'9" d	49'5" d	41'9" d	36'3" d	30'7" d	24'9" d	32'2" d	27'2" d	22'1" d	29'4" d	24'9" d	20'2" d	27'2" d	23'0" d	18'10" d	25'6" d	21'8" d	17'9" d	24'2" d	20'6" d	16'10" d	23'0" d	19'7" d	16'1" d	22'1" d	18'10" d	15'6" d
			10	62'5" d	46'9" d	39'5" d	34'4" d	29'0" d	23'8" d	30'6" d	25'10" d	21'2" d	27'10" d	23'8" d	19'6" d	25'10" d	22'1" d	18'3" d	24'4" d	20'10" d	17'3" d	23'1" d	19'10" d	16'6" d	22'1" d	19'0" d	15'10" d	21'2" d	18'3" d	15'3" d
8		8	61'2" d	45'7" d	38'4" d	33'2" d	28'0" d	22'8" d	29'5" d	24'10" d	20'2" d	26'9" d	22'8" d	18'6" d	24'10" d	21'0" d	17'3" d	23'3" d	19'9" d	16'4" d	22'1" d	18'9" d	15'6" d	21'0" d	17'11" d	14'11" d	20'2" d	17'3" d	14'4" d	
		12	57'6" d	42'9" d	36'0" d	31'3" d	26'6" d	21'8" d	27'10" d	23'8" d	19'6" d	25'5" d	21'8" d	18'0" d	23'8" d	20'3" d	16'11" d	22'3" d	19'2" d	16'0" d	21'2" d	18'3" d	15'4" d	20'3" d	17'6" d	14'9" d	19'6" d	16'11" d	14'3" d	
10		8	54'8" d	40'9" d	34'5" d	30'0" d	25'8" d	21'3" d	26'10" d	23'0" d	19'3" d	24'8" d	21'3" d	17'10" d	23'0" d	19'11" d	16'9" d	21'9" d	18'11" d	16'0" d	20'9" d	18'1" d	15'4" d	19'11" d	17'5" d	14'9" d	19'3" d	16'9" d	14'3" d	
		12	51'3" d	37'3" d	31'1" d	26'11" d	22'11" d	19'0" d	23'3" d	20'0" d	16'6" d	22'10" d	19'0" d	16'0" d	20'3" f	17'10" d	15'1" d	18'9" f	16'11" d	14'4" d	17'8" f	16'2" d	13'10" d	16'9" f	15'7" d	13'4" d	16'1" f	15'1" d	12'11" d	
800JAM350-68, 50ksi		4	6	66'1" d	50'7" d	43'1" d	37'8" d	32'0" d	26'1" d	33'7" d	28'6" d	23'2" d	30'8" d	26'1" d	21'2" d	28'2" f	24'2" d	19'8" d	25'0" f	22'9" d	18'6" d	22'8" f	21'6" d	17'6" d	20'10" f	20'6" d	16'9" d	19'4" f	19'4" f	16'1" d
			8	63'1" d	47'11" d	40'8" d	35'6" d	30'1" d	24'6" d	31'7" d	26'9" d	21'10" d	28'0" f	24'6" d	20'0" d	24'8" f	22'9" d	18'8" d	22'4" f	21'5" d	17'7" d	20'6" f	20'4" d	16'8" d	19'1" f	19'1" f	16'0" d	18'0" f	18'0" f	15'4" d
		6	8	57'9" d	43'4" d	36'7" d	31'9" d	26'10" d	21'10" d	26'2" d	23'10" d	19'5" d	22'7" f	21'10" d	17'10" d	20'2" f	20'2" f	16'8" d	18'5" f	18'5" f	15'9" d	17'1" f	17'1" f	15'0" d	16'1" f	16'1" f	14'4" d	15'3" f	15'3" f	13'10" d
			10	54'8" d	40'11" d	34'7" d	29'5" d	25'7" d	21'0" d	24'7" d	22'10" d	18'10" d	21'7" f	21'0" d	17'5" d	19'8" f	19'7" d	16'4" d	18'3" f	18'3" f	15'6" d	17'2" f	17'2" f	14'9" d	16'4" f	16'4" f	14'3" d	15'6" f	15'6" f	13'9" d
	8	8	53'5" d	39'9" d	33'6" d	27'1" d	24'6" d	19'11" d	22'4" f	21'10" d	17'10" d	19'6" f	19'6" f	16'5" d	17'7" f	17'7" f	15'4" d	16'2" f	16'2" f	14'7" d	15'2" f	15'2" f	13'11" d	14'4" f	14'4" f	13'4" d	13'8" f	13'8" f	12'11" d	
		12	50'2" d	37'5" d	31'6" d	25'4" f	23'4" d	19'3" d	21'5" f	20'11" d	17'5" d	19'1" f	19'1" f	16'2" d	17'7" f	17'7" f	15'2" d	16'6" f	16'6" f	14'5" d	15'7" f	15'7" f	13'10" d	14'9" f	14'9" f	13'4" d	14'1" f	14'1" f	12'11" d	
	10	8	47'7" d	35'8" d	30'3" d	24'8" f	22'9" d	19'0" d	21'6" f	20'7" d	17'3" d	19'6" f	19'0" d	16'1" d	17'11" f	17'11" f	15'2" d	16'8" f	16'8" f	14'5" d	15'8" f	15'8" f	13'10" d	14'10" f	14'10" f	13'4" d	14'2" f	14'2" f	12'11" d	
		12	49'10" d	37'0" d	31'1" d	23'9" f	22'9" d	18'7" d	19'10" f	19'10" f	16'8" d	17'5" f	17'5" f	15'5" d	15'10" f	15'10" f	14'6" d	14'9" f	14'9" f	13'9" d	13'10" f	13'10" f	13'2" d	13'2" f	13'2" f	12'8" d	12'8" f	12'8" f	12'3" d	
	800JAM350-97, 50ksi	4	6	75'3" d	57'8" d	49'3" d	43'1" d	36'8" d	29'10" d	38'5" d	32'8" d	26'7" d	35'2" d	29'10" d	24'3" d	32'8" d	27'9" d	22'7" d	30'9" d	26'1" d	21'2" d	29'1" d	24'8" d	20'1" d	27'9" d	23'6" d	19'2" d	26'7" d	22'7" d	18'4" d
			8	72'0" d	54'10" d	46'7" d	40'8" d	34'6" d	28'1" d	36'3" d	30'9" d	25'0" d	33'1" d	28'1" d	22'10" d	30'9" d	26'1" d	21'3" d	28'10" d	24'6" d	20'0" d	27'4" d	23'3" d	19'0" d	26'1" d	22'2" d	18'2" d	24'5" f	21'3" d	17'5" d
		6	8	66'4" d	49'11" d	42'1" d	36'7" d	30'11" d	25'0" d	32'5" d	27'5" d	22'3" d	29'7" d	25'0" d	20'4" d	27'5" d	23'3" d	18'11" d	25'1" d	21'10" d	17'10" d	23'0" f	20'8" d	17'0" d	21'4" f	19'9" d	16'3" d	20'0" f	18'11" d	15'8" d
			10	63'0" d	47'2" d	39'10" d	34'7" d	29'3" d	23'11" d	30'9" d	26'1" d	21'4" d	28'1" d	23'11" d	19'8" d	26'0" f	22'3" d	18'5" d	23'8" f	21'0" d	17'5" d	21'11" f	20'0" d	16'7" d	20'7" f	19'1" d	15'11" d	19'6" f	18'5" d	15'5" d
8		8	61'8" d	46'0" d	38'8" d	33'6" d	28'3" d	22'10" d	29'8" d	25'0" d	20'4" d	26'10" f	22'10" d	18'8" d	23'9" f	21'3" d	17'5" d	21'6" f	19'11" d	16'5" d	19'9" f	18'11" d	15'8" d	18'6" f	18'1" d	15'0" d	17'5" f	17'5" f	14'6" d	
		10	58'1" d	43'2" d	36'4" d	31'7" d	26'9" d	21'10" d	28'0" d	23'10" d	19'8" d	25'1" f	21'10" d	18'2" d	22'7" f	20'5" d	17'0" d	20'9" f	19'4" d	16'2" d	19'4" f	18'5" d	15'5" d	18'4" f	17'8" d	14'10" d	17'6" f	17'0" d	14'4" d	
10		8	55'2" d	41'1" d	34'8" d	30'3" d	25'10" d	21'5" d	27'0" d	23'2" d	19'4" d	24'6" f	21'5" d	17'11" d	22'5" f	20'1" d	16'11" d	20'11" f	19'0" d	16'1" d	19'9" f	18'2" d	15'5" d	18'8" f	17'6" d	14'10" d	17'9" f	16'11" d	14'4" d	
		12	57'10" d	42'10" d	35'11" d	31'1" d	26'2" d	21'3" d	27'4" f	23'3" d	18'11" d	23'6" f	21'3" d	17'5" d	20'11" f	19'9" d	16'3" d	19'1" f	18'7" d	15'5" d	17'8" f	17'8" f	14'9" d	16'7" f	16'7" f	14'2" d	15'9" f	15'9" f	13'8" d	
800JAM350-118, 50ksi		4	6	80'8" d	62'0" d	53'0" d	46'5" d	39'6" d	32'2" d	41'5" d	35'3" d	28'8" d	37'11" d	32'2" d	26'2" d	35'3" d	29'11" d	24'4" d	33'1" d	28'1" d	22'10" d	31'4" d	26'7" d	21'8" d	29'11" d	25'5" d	20'8" d	28'8" d	24'4" d	19'9" d
			8	77'5" d	59'0" d	50'3" d	43'10" d	37'3" d	30'3" d	39'1" d	33'2" d	26'11" d	35'8" d	30'3" d	24'7" d	33'2" d	28'1" d	22'11" d	31'1" d	26'5" d	21'6" d	29'6" d	25'0" d	20'5" d	28'1" d	23'11" d	19'6" d	26'11" d	22'11" d	18'9" d
		6	8	71'7" d	53'10" d	45'6" d	39'7" d	33'5" d	27'0" d	35'1" d	29'7" d	24'0" d	31'11" d	27'0" d	21'11" d	29'7" d	25'1" d	20'5" d	27'9" d	23'6" d	19'2" d	26'3" d	22'3" d	18'3" d	25'1" d	21'3" d	17'5" d	23'8" f	20'5" d	16'9" d
			10	68'0" d	51'0" d	43'0" d	37'4" d	31'7" d	25'8" d	33'2" d	28'1" d	22'11" d	30'3" d	25'8" d	21'1" d	28'1" d	23'11" d	19'8" d	26'5" d	22'6" d	18'7" d	25'1" d	21'5" d	17'9" d	23'11" f	20'6" d	17'0" d	22'6" f	19'8" d	16'5" d
	8	8	66'8" d	49'9" d																										

# Exterior Wall Framing & Accessories JamStud® Non Load Bearing Opening Allowable Heights

## Also use JamStud® in Header Assemblies

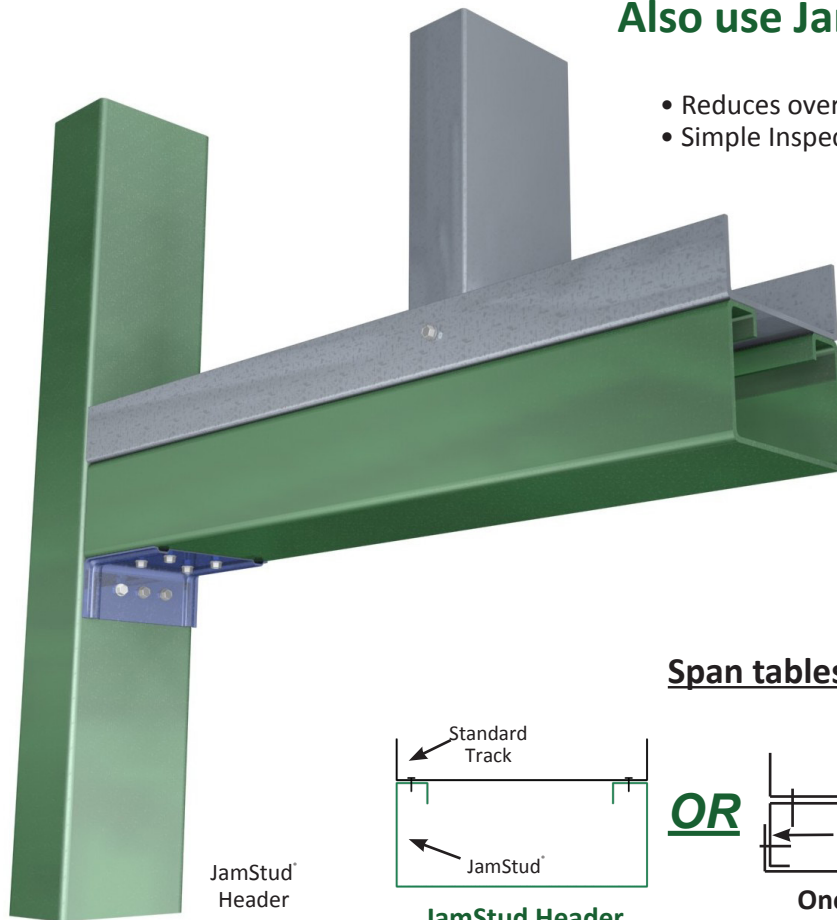

- Reduces overall materials used
- Simple Inspection
- Speeds installation
- Fewer fasteners

Span tables begin on page 33.

\* The top track seen in the assemblies above is to capture the cripple studs above and does not factor in the design of the header.

## JamStud® Project Example



Example of a opening made of multiple (S) section studs. Seven studs and 2 tracks are utilized in this jamb, creating a significant increase in both materials and labor costs. By taking advantage of TSN's free design assist service or by utilizing the Quick Member Selector in SteelSmart® System software (SSS), the design could have been optimized using far fewer members. SSS is available online at [www.steelSMARTsystem.com](http://www.steelSMARTsystem.com).

# Exterior Wall Framing & Accessories Load Bearing Opening Design Example

## Designing JamStud®

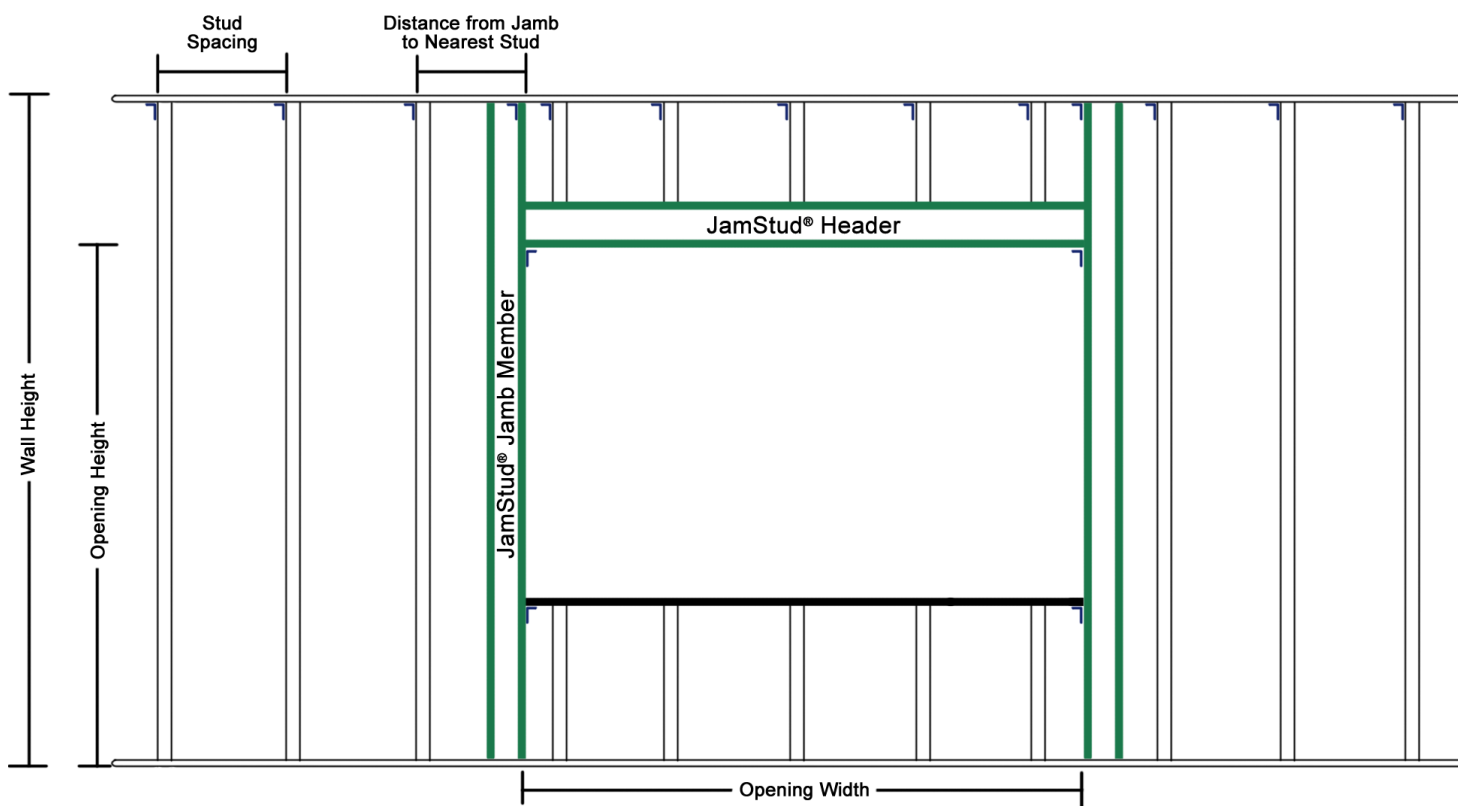

### 1. Basis for Tables

The JamStud Load Bearing Opening Allowable Axial Loads tables in this catalog cover the following basic load combinations for the Allowable Stress Design (ASD) Method (IBC 2018 and ASCE 7-16). Listed wind pressures represent calculated design wind pressure ( $0.6W$  based on IBC 2018).

- IBC 2018 / ASCE 7-16
  - i.  $D + 0.6W_{MWFRS}^*$  (Strength Determination)
  - ii.  $D + 0.75L + 0.75(0.6W_{MWFRS}^*)$  (Strength Determination)
  - iii.  $D + 0.70(0.6W_{C\&C}^{**})$  (Deflection Determination)

\* MWFRS: Main Wind Force Resisting System

\*\* C&C: Component and Cladding

For deflection determination IBC 2018 Sec. 1604.3 and AISI S240-15 North American Standard for Cold-Formed Steel Structural Framing Sec. B1.1.2. allows for a reduction factor of 0.7 on the component & cladding wind load ( $0.7W_{C\&C}$ ).

The “JamStud Allowable Axial Loads for Load Bearing Openings” tables are based on the following assumptions:

- 4-Way distribution of lateral wind pressure acting on the opening plus
- Opening height extends from floor level to the bottom surface of the header
- Jamb member supports wind pressure from opening, wind pressure from half distance to adjacent stud, and header reaction

The input for the tables include: the JamStud section, the opening width (ft.), the opening height (ft.), the design wind pressures ( $0.6W_{MWFRS}$  and  $0.6W_{C\&C}$ , psf), and the specified deflection limit. The output from the tables reflects the allowable JamStud axial load (kips) and the maximum deflection at mid height.

# Exterior Wall Framing & Accessories Load Bearing Opening Design Example

## 2. Design Example

### Given:

Service (Un-factored) Loads:

Axial Dead Load in Jamb (Reaction from header and floor above)	= 5.5 kips
Axial Live Load in Jamb (Reaction from header and floor above)	= 7.5 kips
Wind Pressure ( $0.6W_{MWFRS}$ )(ASCE 7-16)	= 28 psf
Wind Pressure ( $0.6W_{C\&C}$ )(ASCE 7-16)	= 40 psf

Wall Width	= 6.0 in.
Wall Height	= 12.0 ft.
Opening Width	= 8.0 ft.
Specified Deflection Limit	= L/360
Bridging (Lateral Bracing) at a maximum vertical spacing of 48" o.c.	

### Calculations:

- a) Use the  $D + 0.6W_{MWFRS}$  (IBC 2018 / ASCE 7-16) load combination for strength to get the first estimate of the JamStud.
- |                              |                                 |
|------------------------------|---------------------------------|
| Combination total axial load | = 5.5 kips                      |
| $0.6W_{MWFRS}$               | = 28 psf (approximately 30 psf) |
- Go to the Lateral Wind Pressure = 30 psf column with a 6 in. wall width, an 8 ft. opening width, and 12 ft. wall height, and choose 600JAM250-97 (50 ksi) with an axial resistance of 8.93 kips > 5.5 kips. OK
- b) Check the  $D + 0.75L + 0.75(0.6W_{MWFRS})$  (IBC 2018 / ASCE 7-16) load combination for strength.
- |                              |                                 |
|------------------------------|---------------------------------|
| Combination total axial load | = 5.5 kips + 0.75(7.5 kips)     |
|                              | = 11.125 kips                   |
| $0.75(0.6W_{MWFRS})$         | = 0.75(28 psf)                  |
|                              | = 21 psf (approximately 20 psf) |
- Go to the Lateral Wind Pressure = 20 psf column with a 6 in. wall width, an 8 ft. opening width, and 12 ft. wall height. The axial resistance for 600JAM250-97 (50 ksi) is 11.69 kips > 11.125 kips. OK
- c) Check the  $0.70(0.6W_{C\&C})$  (IBC 2018 / ASCE 7-16) load combination for deflection. The specified limit is L/360.
- Go to the Lateral Wind pressure = 40 psf column with a 6 in. wall width, an 8ft. opening width, and 12 ft. wall height. The deflection parameter for 600JAM250-97 (50 ksi) is 6, which indicates that  $L/600 \leq \Delta < L/360$ . OK

### Conclusion:

Use 600JAM250-97 (50 ksi) (with design thickness = 0.1017" and  $F_y = 50$  ksi) with 3 lines of bridging arranged so that the maximum spacing does not exceed 48 in. (4 ft.)

## 3. Extra Design Considerations

- a) Check lateral end reaction of the jamb for web crippling if applicable.
- b) If the specified axial dead load and live load acting on the jamb is significantly larger than the specified wind load, the following basic load combination needs to be checked as well:
- |       |   |
|-------|---|
| D + L | (Strength Determination based on IBC 2018/ ASCE 7-16) |
|-------|---|

## Important Notes

- All values are based on a tributary width equal to one-half of the opening width plus one-half of the stud spacing, where the stud spacing = 16" o.c.
- Lateral loads have not been modified for strength checks: full loads are applied.
- Listed wind pressures represent calculated design wind pressure (0.6W based on 2018 IBC).
- 15 psf and higher wind pressures have been multiplied by 0.7 for deflection determination, in accordance with footnote "f" of IBC table 1604.3. The 5 psf pressure has not been reduced for deflection checks.
- Allowable loads are based on weak axis and torsional bracing at 48" o.c. maximum for axial load calculation and continuous support of each flange for flexural calculation.
- Sections are punched with a standard punch-out 1.5" wide located along the centerline of the web 24" o.c.
- The allowable axial or flexural strength for distortional buckling is based on an assumed  $k_{\phi} = 0$ .
- Allowable loads are based on checks for punched section under axial load and flexural moment.
- Weak axis and torsional bracing should have sufficient stiffness and strength to resist the axial load.
- Strength increase due to cold forming is incorporated in calculating allowable loads as per AISI S100-16 Spec, Sec. A3.3.2 (3).
- Moment of inertia for deflection is optimized based on the allowable flexural strength at service loads.
- Loads in tables are in kips/stud.
- The following superscripts are used for maximum deflection ( $\Delta$ ) calculated at mid height:

"7" for  $L/720 \leq \Delta < L/600$   
 "6" for  $L/600 \leq \Delta < L/360$   
 "3" for  $L/360 \leq \Delta < L/240$   
 "2" for  $L/240 \leq \Delta < L/120$   
 "1" for  $\Delta \geq 120$

JamStud® Allowable Axial Loads for Load Bearing Openings											
Section	Opening Width (ft)	Wall Height (ft)	Lateral Wind Pressure (psf)								
			5	15	20	25	30	35	40	45	50
350JAM250-43, 50ksi	4	8	4.57	3.52	3.00	2.48 <sup>7</sup>	1.96 <sup>6</sup>	1.44 <sup>5</sup>	0.92 <sup>6</sup>	0.40 <sup>3</sup>	
		9	4.17	2.93 <sup>7</sup>	2.31 <sup>6</sup>	1.68 <sup>6</sup>	1.06 <sup>3</sup>	0.44 <sup>3</sup>			
		10	3.76	2.32 <sup>6</sup>	1.61 <sup>6</sup>	0.89 <sup>3</sup>	0.18 <sup>3</sup>				
		12	2.86 <sup>7</sup>	1.15 <sup>3</sup>	0.29 <sup>2</sup>						
	6	8	4.37	2.94	2.22 <sup>6</sup>	1.50 <sup>6</sup>	0.79 <sup>6</sup>	0.07 <sup>3</sup>			
		9	3.94	2.23 <sup>6</sup>	1.37 <sup>6</sup>	0.52 <sup>3</sup>					
		10	3.49	1.52 <sup>6</sup>	0.53 <sup>3</sup>						
		12	2.54 <sup>6</sup>	0.18 <sup>2</sup>							
	8	8	4.18	2.35 <sup>6</sup>	1.44 <sup>6</sup>	0.53 <sup>3</sup>					
		9	3.70	1.53 <sup>6</sup>	0.44 <sup>3</sup>						
		10	3.22 <sup>7</sup>	0.71 <sup>3</sup>							
	10	8	3.98	1.76 <sup>6</sup>	0.66 <sup>6</sup>						
9		3.47 <sup>7</sup>	0.83 <sup>3</sup>								
350JAM250-54, 50ksi	4	8	6.26	5.19	4.66	4.13	3.59 <sup>7</sup>	3.06 <sup>6</sup>	2.53 <sup>6</sup>	1.99 <sup>6</sup>	1.46 <sup>6</sup>
		9	5.68	4.43	3.80 <sup>7</sup>	3.18 <sup>6</sup>	2.55 <sup>6</sup>	1.92 <sup>6</sup>	1.30 <sup>3</sup>	0.67 <sup>3</sup>	0.04 <sup>3</sup>
		10	5.07	3.65 <sup>7</sup>	2.94 <sup>6</sup>	2.24 <sup>6</sup>	1.53 <sup>3</sup>	0.82 <sup>3</sup>	0.11 <sup>3</sup>		
		12	3.86	2.20 <sup>6</sup>	1.38 <sup>3</sup>	0.55 <sup>2</sup>					
		14	2.87 <sup>6</sup>	1.05 <sup>2</sup>	0.14 <sup>2</sup>						
	6	8	6.06	4.59	3.86 <sup>7</sup>	3.13 <sup>6</sup>	2.39 <sup>6</sup>	1.66 <sup>6</sup>	0.93 <sup>3</sup>	0.20 <sup>3</sup>	
		9	5.45	3.72 <sup>7</sup>	2.86 <sup>6</sup>	2.00 <sup>6</sup>	1.14 <sup>3</sup>	0.28 <sup>3</sup>			
		10	4.80	2.86 <sup>6</sup>	1.88 <sup>3</sup>	0.91 <sup>3</sup>					
		12	3.55 <sup>6</sup>	1.27 <sup>3</sup>	0.13 <sup>2</sup>						
	8	8	5.86	3.99	3.06 <sup>6</sup>	2.13 <sup>6</sup>	1.20 <sup>6</sup>	0.26 <sup>3</sup>			
		9	5.21	3.02 <sup>6</sup>	1.92 <sup>6</sup>	0.83 <sup>3</sup>					
		10	4.54	2.06 <sup>6</sup>	0.82 <sup>3</sup>						
		12	3.24 <sup>6</sup>	0.34 <sup>2</sup>							
	10	8	5.66	3.39 <sup>7</sup>	2.26 <sup>6</sup>	1.13 <sup>6</sup>					
		9	4.98	2.31 <sup>6</sup>	0.98 <sup>3</sup>						
		10	4.27 <sup>7</sup>	1.26 <sup>3</sup>							
350JAM250-68, 50ksi	4	8	8.07	7.07	6.56	6.06	5.55	5.05 <sup>7</sup>	4.55 <sup>6</sup>	4.04 <sup>6</sup>	3.54 <sup>6</sup>
		9	7.34	6.16	5.57	4.98 <sup>7</sup>	4.40 <sup>6</sup>	3.81 <sup>6</sup>	3.22 <sup>6</sup>	2.63 <sup>6</sup>	2.04 <sup>3</sup>
		10	6.59	5.26	4.59 <sup>7</sup>	3.93 <sup>6</sup>	3.26 <sup>6</sup>	2.59 <sup>3</sup>	1.93 <sup>3</sup>	1.26 <sup>3</sup>	0.60 <sup>3</sup>
		12	5.09	3.54 <sup>6</sup>	2.76 <sup>3</sup>	1.99 <sup>3</sup>	1.21 <sup>2</sup>	0.44 <sup>2</sup>			
		14	3.87 <sup>7</sup>	2.17 <sup>3</sup>	1.32 <sup>2</sup>	0.47 <sup>2</sup>					
	6	8	7.88	6.50	5.81	5.11 <sup>7</sup>	4.42 <sup>6</sup>	3.73 <sup>6</sup>	3.04 <sup>6</sup>	2.34 <sup>6</sup>	1.65 <sup>3</sup>
		9	7.12	5.50	4.69 <sup>7</sup>	3.88 <sup>6</sup>	3.07 <sup>6</sup>	2.26 <sup>3</sup>	1.45 <sup>3</sup>	0.64 <sup>3</sup>	
		10	6.34	4.51 <sup>6</sup>	3.59 <sup>6</sup>	2.68 <sup>3</sup>	1.76 <sup>3</sup>	0.85 <sup>3</sup>			
		12	4.80	2.67 <sup>3</sup>	1.60 <sup>3</sup>	0.54 <sup>2</sup>					
		14	3.55 <sup>6</sup>	1.22 <sup>2</sup>	0.05 <sup>2</sup>						
	8	8	7.70	5.93	5.05 <sup>7</sup>	4.17 <sup>6</sup>	3.29 <sup>6</sup>	2.41 <sup>6</sup>	1.53 <sup>3</sup>	0.64 <sup>3</sup>	
		9	6.90	4.84 <sup>7</sup>	3.81 <sup>6</sup>	2.77 <sup>6</sup>	1.74 <sup>3</sup>	0.71 <sup>3</sup>			
		10	6.09	3.76 <sup>6</sup>	2.59 <sup>3</sup>	1.43 <sup>3</sup>	0.26 <sup>2</sup>				
		12	4.51 <sup>6</sup>	1.80 <sup>3</sup>	0.44 <sup>2</sup>						
	10	8	7.51	5.37	4.30 <sup>6</sup>	3.23 <sup>6</sup>	2.15 <sup>6</sup>	1.08 <sup>3</sup>	0.01 <sup>3</sup>		
		9	6.68	4.17 <sup>6</sup>	2.92 <sup>6</sup>	1.67 <sup>3</sup>	0.41 <sup>3</sup>				
10		5.84	3.01 <sup>6</sup>	1.60 <sup>3</sup>	0.18 <sup>2</sup>						
12		4.22 <sup>6</sup>	0.92 <sup>2</sup>								

Refer to Important Table Notes on Page 17

JamStud® Allowable Axial Loads for Load Bearing Openings											
Section	Opening Width (ft)	Wall Height (ft)	Lateral Wind Pressure (psf)								
			5	15	20	25	30	35	40	45	50
350JAM250-97, 50ksi	4	8	12.14	11.27	10.84	10.40	9.97	9.53	9.10	8.66	8.23 <sup>7</sup>
		9	11.01	10.00	9.50	9.00	8.49	7.99 <sup>7</sup>	7.48 <sup>6</sup>	6.98 <sup>6</sup>	6.47 <sup>6</sup>
		10	9.85	8.73	8.16	7.60 <sup>7</sup>	7.04 <sup>6</sup>	6.47 <sup>6</sup>	5.91 <sup>6</sup>	5.35 <sup>6</sup>	4.78 <sup>3</sup>
		12	7.63	6.34 <sup>7</sup>	5.70 <sup>6</sup>	5.05 <sup>6</sup>	4.41 <sup>3</sup>	3.76 <sup>3</sup>	3.12 <sup>3</sup>	2.47 <sup>2</sup>	1.83 <sup>2</sup>
		14	5.92	4.51 <sup>6</sup>	3.81 <sup>3</sup>	3.11 <sup>3</sup>	2.41 <sup>2</sup>	1.71 <sup>2</sup>	1.01 <sup>2</sup>	0.30 <sup>2</sup>	
		16	4.62 <sup>5</sup>	3.14 <sup>3</sup>	2.39 <sup>2</sup>	1.65 <sup>2</sup>	0.91 <sup>2</sup>	0.16 <sup>1</sup>			
	6	8	11.98	10.78	10.18	9.59	8.99	8.39 <sup>7</sup>	7.79 <sup>6</sup>	7.19 <sup>6</sup>	6.59 <sup>6</sup>
		9	10.82	9.44	8.74	8.05 <sup>7</sup>	7.36 <sup>6</sup>	6.66 <sup>6</sup>	5.97 <sup>6</sup>	5.28 <sup>6</sup>	4.58 <sup>3</sup>
		10	9.64	8.09	7.32 <sup>7</sup>	6.54 <sup>6</sup>	5.77 <sup>6</sup>	4.99 <sup>3</sup>	4.22 <sup>3</sup>	3.45 <sup>3</sup>	2.67 <sup>3</sup>
		12	7.39	5.61 <sup>6</sup>	4.73 <sup>3</sup>	3.84 <sup>3</sup>	2.96 <sup>2</sup>	2.07 <sup>2</sup>	1.19 <sup>2</sup>	0.30 <sup>2</sup>	
		14	5.65 <sup>7</sup>	3.72 <sup>3</sup>	2.76 <sup>2</sup>	1.79 <sup>2</sup>	0.83 <sup>2</sup>				
		16	4.34 <sup>5</sup>	2.30 <sup>2</sup>	1.28 <sup>2</sup>	0.26 <sup>1</sup>					
	8	8	11.82	10.29	9.53	8.77	8.01 <sup>7</sup>	7.25 <sup>6</sup>	6.48 <sup>6</sup>	5.72 <sup>6</sup>	4.96 <sup>6</sup>
		9	10.64	8.87	7.99 <sup>7</sup>	7.10 <sup>6</sup>	6.22 <sup>6</sup>	5.34 <sup>6</sup>	4.46 <sup>3</sup>	3.57 <sup>3</sup>	2.69 <sup>3</sup>
		10	9.43	7.46 <sup>7</sup>	6.47 <sup>6</sup>	5.49 <sup>6</sup>	4.50 <sup>3</sup>	3.52 <sup>3</sup>	2.53 <sup>3</sup>	1.55 <sup>2</sup>	0.56 <sup>2</sup>
		12	7.14	4.89 <sup>6</sup>	3.76 <sup>3</sup>	2.64 <sup>2</sup>	1.51 <sup>2</sup>	0.38 <sup>2</sup>			
		14	5.39 <sup>6</sup>	2.93 <sup>2</sup>	1.71 <sup>2</sup>	0.48 <sup>2</sup>					
		16	4.06 <sup>3</sup>	1.46 <sup>2</sup>	0.16 <sup>1</sup>						
	10	8	11.65	9.80	8.88	7.95 <sup>7</sup>	7.03 <sup>6</sup>	6.10 <sup>6</sup>	5.18 <sup>6</sup>	4.25 <sup>3</sup>	3.33 <sup>3</sup>
		9	10.45	8.30	7.23 <sup>6</sup>	6.16 <sup>6</sup>	5.09 <sup>6</sup>	4.01 <sup>3</sup>	2.94 <sup>3</sup>	1.87 <sup>3</sup>	0.80 <sup>2</sup>
10		9.22	6.83 <sup>6</sup>	5.63 <sup>6</sup>	4.43 <sup>3</sup>	3.23 <sup>3</sup>	2.04 <sup>2</sup>	0.84 <sup>2</sup>			
12		6.90 <sup>7</sup>	4.17 <sup>3</sup>	2.80 <sup>2</sup>	1.43 <sup>2</sup>	0.06 <sup>2</sup>					
14		5.13 <sup>6</sup>	2.15 <sup>2</sup>	0.65 <sup>2</sup>							
16		3.79 <sup>3</sup>	0.63 <sup>2</sup>								
350JAM350-68, 50ksi	4	8	8.70	7.68	7.17	6.67	6.16	5.65	5.14	4.63 <sup>7</sup>	4.12 <sup>6</sup>
		9	8.14	6.92	6.30	5.69	5.08 <sup>7</sup>	4.47 <sup>6</sup>	3.86 <sup>6</sup>	3.24 <sup>6</sup>	2.63 <sup>6</sup>
		10	7.60	6.17	5.45	4.73 <sup>7</sup>	4.01 <sup>6</sup>	3.29 <sup>6</sup>	2.57 <sup>6</sup>	1.86 <sup>3</sup>	1.14 <sup>3</sup>
		12	6.30	4.51 <sup>6</sup>	3.62 <sup>6</sup>	2.72 <sup>3</sup>	1.83 <sup>3</sup>	0.93 <sup>3</sup>	0.04 <sup>2</sup>		
		14	5.03	2.98 <sup>6</sup>	1.95 <sup>3</sup>	0.93 <sup>2</sup>					
		16	3.86 <sup>6</sup>	1.67 <sup>3</sup>	0.57 <sup>2</sup>						
	6	8	8.51	7.11	6.41	5.71	5.01	4.31 <sup>7</sup>	3.61 <sup>6</sup>	2.91 <sup>6</sup>	2.21 <sup>6</sup>
		9	7.91	6.23	5.39	4.54 <sup>7</sup>	3.70 <sup>6</sup>	2.86 <sup>6</sup>	2.02 <sup>6</sup>	1.18 <sup>3</sup>	0.34 <sup>3</sup>
		10	7.34	5.36	4.37 <sup>6</sup>	3.38 <sup>6</sup>	2.39 <sup>6</sup>	1.41 <sup>3</sup>	0.42 <sup>3</sup>		
		12	5.97	3.51 <sup>6</sup>	2.28 <sup>3</sup>	1.04 <sup>3</sup>					
		14	4.64 <sup>6</sup>	1.83 <sup>3</sup>	0.42 <sup>2</sup>						
		16	3.45 <sup>6</sup>	0.44 <sup>2</sup>							
	8	8	8.32	6.54	5.65	4.76 <sup>7</sup>	3.87 <sup>6</sup>	2.98 <sup>6</sup>	2.09 <sup>6</sup>	1.20 <sup>6</sup>	0.30 <sup>3</sup>
		9	7.68	5.54	4.47 <sup>6</sup>	3.40 <sup>6</sup>	2.33 <sup>6</sup>	1.25 <sup>3</sup>	0.18 <sup>3</sup>		
		10	7.07	4.55 <sup>6</sup>	3.29 <sup>6</sup>	2.04 <sup>3</sup>	0.78 <sup>3</sup>				
		12	5.63 <sup>7</sup>	2.50 <sup>3</sup>	0.93 <sup>3</sup>						
		14	4.26 <sup>6</sup>	0.67 <sup>2</sup>							
		16									
	10	8	8.13	5.97	4.88 <sup>7</sup>	3.80 <sup>6</sup>	2.72 <sup>6</sup>	1.64 <sup>6</sup>	0.56 <sup>3</sup>		
		9	7.45	4.85 <sup>7</sup>	3.55 <sup>6</sup>	2.25 <sup>6</sup>	0.95 <sup>3</sup>				
10		6.80	3.74 <sup>6</sup>	2.22 <sup>3</sup>	0.69 <sup>3</sup>						
12		5.30 <sup>6</sup>	1.49 <sup>3</sup>								
362JAM250-43, 50ksi	4	8	4.74	3.71	3.19	2.68 <sup>7</sup>	2.16 <sup>6</sup>	1.64 <sup>6</sup>	1.13 <sup>6</sup>	0.61 <sup>6</sup>	0.09 <sup>3</sup>
		9	4.36	3.12	2.50 <sup>6</sup>	1.88 <sup>6</sup>	1.26 <sup>6</sup>	0.64 <sup>3</sup>	0.02 <sup>3</sup>		
		10	3.95	2.52 <sup>6</sup>	1.80 <sup>6</sup>	1.08 <sup>3</sup>	0.37 <sup>3</sup>				
		12	3.09 <sup>7</sup>	1.33 <sup>3</sup>	0.46 <sup>3</sup>						
		14	2.27 <sup>6</sup>	0.31 <sup>2</sup>							
	6	8	4.55	3.13	2.42 <sup>7</sup>	1.71 <sup>6</sup>	1.00 <sup>6</sup>	0.28 <sup>3</sup>			
		9	4.13	2.42 <sup>6</sup>	1.57 <sup>6</sup>	0.72 <sup>3</sup>					
		10	3.69	1.71 <sup>6</sup>	0.73 <sup>3</sup>						
		12	2.76 <sup>6</sup>	0.35 <sup>2</sup>							
	8	8	4.36	2.55 <sup>7</sup>	1.64 <sup>6</sup>	0.74 <sup>6</sup>					
		9	3.90	1.73 <sup>6</sup>	0.64 <sup>3</sup>						
		10	3.42 <sup>7</sup>	0.91 <sup>3</sup>							
	10	8	4.16	1.97 <sup>6</sup>	0.87 <sup>6</sup>						
		9	3.66	1.03 <sup>6</sup>							
10		3.15 <sup>6</sup>	0.10 <sup>3</sup>								

Refer to Important Table Notes on Page 17

JamStud® Allowable Axial Loads for Load Bearing Openings											
Section	Opening Width (ft)	Wall Height (ft)	Lateral Wind Pressure (psf)								
			5	15	20	25	30	35	40	45	50
362JAM250-54, 50ksi	4	8	6.54	5.48	4.95	4.42	3.88 <sup>7</sup>	3.35 <sup>6</sup>	2.82 <sup>6</sup>	2.29 <sup>6</sup>	1.75 <sup>6</sup>
		9	5.99	4.73	4.10	3.47 <sup>6</sup>	2.84 <sup>6</sup>	2.21 <sup>6</sup>	1.58 <sup>6</sup>	0.95 <sup>3</sup>	0.32 <sup>3</sup>
		10	5.41	3.97 <sup>7</sup>	3.25 <sup>6</sup>	2.53 <sup>6</sup>	1.81 <sup>3</sup>	1.09 <sup>3</sup>	0.37 <sup>3</sup>		
		12	4.20	2.49 <sup>6</sup>	1.63 <sup>3</sup>	0.78 <sup>3</sup>					
		14	3.15 <sup>6</sup>	1.26 <sup>3</sup>	0.32 <sup>2</sup>						
	6	8	6.34	4.88	4.15	3.42 <sup>7</sup>	2.69 <sup>6</sup>	1.95 <sup>6</sup>	1.22 <sup>6</sup>	0.49 <sup>3</sup>	
		9	5.75	4.02 <sup>7</sup>	3.15 <sup>6</sup>	2.29 <sup>6</sup>	1.42 <sup>3</sup>	0.55 <sup>3</sup>			
		10	5.14	3.16 <sup>6</sup>	2.17 <sup>6</sup>	1.18 <sup>3</sup>	0.19 <sup>3</sup>				
		12	3.88 <sup>7</sup>	1.53 <sup>3</sup>	0.35 <sup>2</sup>						
	8	8	6.14	4.28	3.35 <sup>6</sup>	2.42 <sup>6</sup>	1.49 <sup>6</sup>	0.56 <sup>3</sup>			
		9	5.52	3.31 <sup>6</sup>	2.21 <sup>6</sup>	1.11 <sup>3</sup>					
		10	4.87	2.35 <sup>6</sup>	1.09 <sup>3</sup>						
		12	3.56 <sup>6</sup>	0.56 <sup>2</sup>							
	10	8	5.95	3.68 <sup>7</sup>	2.55 <sup>6</sup>	1.42 <sup>6</sup>	0.29 <sup>3</sup>				
		9	5.28	2.60 <sup>6</sup>	1.26 <sup>3</sup>						
		10	4.60 <sup>7</sup>	1.54 <sup>3</sup>	0.01 <sup>3</sup>						
362JAM250-68, 50ksi	4	8	8.52	7.51	7.00	6.49	5.98	5.47	4.97 <sup>7</sup>	4.46 <sup>6</sup>	3.95 <sup>6</sup>
		9	7.80	6.61	6.01	5.41	4.81 <sup>7</sup>	4.22 <sup>6</sup>	3.62 <sup>6</sup>	3.02 <sup>6</sup>	2.42 <sup>6</sup>
		10	7.05	5.70	5.02 <sup>7</sup>	4.34 <sup>6</sup>	3.66 <sup>6</sup>	2.98 <sup>6</sup>	2.30 <sup>3</sup>	1.62 <sup>3</sup>	0.94 <sup>3</sup>
		12	5.53	3.93 <sup>6</sup>	3.13 <sup>6</sup>	2.33 <sup>3</sup>	1.52 <sup>3</sup>	0.72 <sup>2</sup>			
		14	4.23 <sup>7</sup>	2.47 <sup>3</sup>	1.59 <sup>3</sup>	0.71 <sup>2</sup>					
	6	8	8.33	6.93	6.24	5.54	4.84 <sup>7</sup>	4.14 <sup>6</sup>	3.44 <sup>6</sup>	2.75 <sup>6</sup>	2.05 <sup>6</sup>
		9	7.58	5.93	5.11 <sup>7</sup>	4.29 <sup>6</sup>	3.47 <sup>6</sup>	2.65 <sup>6</sup>	1.82 <sup>3</sup>	1.00 <sup>3</sup>	0.18 <sup>3</sup>
		10	6.80	4.93 <sup>7</sup>	4.00 <sup>6</sup>	3.06 <sup>6</sup>	2.13 <sup>3</sup>	1.19 <sup>3</sup>	0.26 <sup>3</sup>		
		12	5.23	3.03 <sup>6</sup>	1.93 <sup>3</sup>	0.82 <sup>2</sup>					
	8	8	8.14	6.36	5.47	4.59 <sup>6</sup>	3.70 <sup>6</sup>	2.81 <sup>6</sup>	1.92 <sup>6</sup>	1.03 <sup>3</sup>	0.14 <sup>3</sup>
		9	7.35	5.26 <sup>7</sup>	4.22 <sup>6</sup>	3.17 <sup>6</sup>	2.12 <sup>3</sup>	1.08 <sup>3</sup>	0.03 <sup>3</sup>		
		10	6.54	4.17 <sup>6</sup>	2.98 <sup>6</sup>	1.79 <sup>3</sup>	0.60 <sup>3</sup>				
		12	4.93 <sup>7</sup>	2.13 <sup>3</sup>	0.72 <sup>2</sup>						
	10	8	7.95	5.79	4.71 <sup>7</sup>	3.63 <sup>6</sup>	2.56 <sup>6</sup>	1.48 <sup>3</sup>	0.40 <sup>3</sup>		
		9	7.13	4.59 <sup>6</sup>	3.32 <sup>6</sup>	2.05 <sup>3</sup>	0.78 <sup>3</sup>				
		10	6.29	3.40 <sup>6</sup>	1.96 <sup>3</sup>	0.51 <sup>3</sup>					
12		4.63 <sup>6</sup>	1.22 <sup>3</sup>								
362JAM250-97, 50ksi	4	8	12.83	11.96	11.52	11.08	10.64	10.21	9.77	9.33	8.89 <sup>7</sup>
		9	11.72	10.70	10.19	9.68	9.17	8.66 <sup>7</sup>	8.15 <sup>7</sup>	7.64 <sup>6</sup>	7.13 <sup>6</sup>
		10	10.57	9.42	8.85	8.27	7.70 <sup>7</sup>	7.12 <sup>6</sup>	6.55 <sup>6</sup>	5.98 <sup>6</sup>	5.40 <sup>6</sup>
		12	8.28	6.95 <sup>7</sup>	6.29 <sup>6</sup>	5.62 <sup>6</sup>	4.96 <sup>3</sup>	4.29 <sup>3</sup>	3.63 <sup>3</sup>	2.97 <sup>2</sup>	2.30 <sup>2</sup>
		14	6.44	4.99 <sup>6</sup>	4.27 <sup>3</sup>	3.55 <sup>3</sup>	2.82 <sup>2</sup>	2.10 <sup>2</sup>	1.37 <sup>2</sup>	0.65 <sup>2</sup>	
	6	8	12.67	11.46	10.86	10.26	9.66	9.06	8.45 <sup>7</sup>	7.85 <sup>6</sup>	7.25 <sup>6</sup>
		9	11.53	10.13	9.42	8.72	8.02 <sup>7</sup>	7.32 <sup>6</sup>	6.62 <sup>6</sup>	5.91 <sup>6</sup>	5.21 <sup>6</sup>
		10	10.36	8.78	7.99 <sup>7</sup>	7.20 <sup>6</sup>	6.41 <sup>6</sup>	5.62 <sup>6</sup>	4.83 <sup>3</sup>	4.04 <sup>3</sup>	3.25 <sup>3</sup>
		12	8.03	6.20 <sup>6</sup>	5.29 <sup>6</sup>	4.38 <sup>3</sup>	3.46 <sup>3</sup>	2.55 <sup>2</sup>	1.64 <sup>2</sup>	0.73 <sup>2</sup>	
		14	6.17 <sup>7</sup>	4.18 <sup>3</sup>	3.18 <sup>3</sup>	2.19 <sup>2</sup>	1.19 <sup>2</sup>	0.20 <sup>2</sup>			
		16	4.76 <sup>6</sup>	2.65 <sup>2</sup>	1.59 <sup>2</sup>	0.54 <sup>2</sup>					
	8	8	12.50	10.97	10.21	9.44	8.67 <sup>7</sup>	7.91 <sup>6</sup>	7.14 <sup>6</sup>	6.37 <sup>6</sup>	5.61 <sup>6</sup>
		9	11.34	9.55	8.66 <sup>7</sup>	7.76 <sup>6</sup>	6.87 <sup>6</sup>	5.98 <sup>6</sup>	5.08 <sup>3</sup>	4.19 <sup>3</sup>	3.29 <sup>3</sup>
		10	10.14	8.13 <sup>7</sup>	7.12 <sup>6</sup>	6.12 <sup>6</sup>	5.11 <sup>3</sup>	4.11 <sup>3</sup>	3.10 <sup>3</sup>	2.10 <sup>2</sup>	1.09 <sup>2</sup>
		12	7.78	5.46 <sup>6</sup>	4.29 <sup>3</sup>	3.13 <sup>3</sup>	1.97 <sup>2</sup>	0.81 <sup>2</sup>			
		14	5.90 <sup>6</sup>	3.36 <sup>3</sup>	2.10 <sup>2</sup>	0.83 <sup>2</sup>					
10	8	12.34	10.48	9.55	8.62 <sup>7</sup>	7.69 <sup>6</sup>	6.76 <sup>6</sup>	5.83 <sup>6</sup>	4.90 <sup>6</sup>	3.97 <sup>3</sup>	
	9	11.15	8.98	7.89 <sup>6</sup>	6.81 <sup>6</sup>	5.72 <sup>6</sup>	4.64 <sup>3</sup>	3.55 <sup>3</sup>	2.46 <sup>3</sup>	1.38 <sup>2</sup>	
	10	9.93	7.48 <sup>6</sup>	6.26 <sup>6</sup>	5.04 <sup>3</sup>	3.82 <sup>3</sup>	2.60 <sup>3</sup>	1.38 <sup>2</sup>	0.16 <sup>2</sup>		
	12	7.53 <sup>7</sup>	4.71 <sup>3</sup>	3.30 <sup>3</sup>	1.89 <sup>2</sup>	0.48 <sup>2</sup>					
	14	5.63 <sup>6</sup>	2.55 <sup>2</sup>	1.01 <sup>2</sup>							
	16	4.19 <sup>3</sup>	0.92 <sup>2</sup>								

Refer to Important Table Notes on Page 17

JamStud® Allowable Axial Loads for Load Bearing Openings											
Section	Opening Width (ft)	Wall Height (ft)	Lateral Wind Pressure (psf)								
			5	15	20	25	30	35	40	45	50
362JAM350-68, 50ksi	4	8	9.10	8.08	7.58	7.07	6.56	6.05	5.54	5.03 <sup>7</sup>	4.52 <sup>7</sup>
		9	8.51	7.29	6.68	6.06	5.45	4.84 <sup>7</sup>	4.23 <sup>6</sup>	3.62 <sup>6</sup>	3.01 <sup>6</sup>
		10	7.96	6.53	5.81	5.09 <sup>7</sup>	4.37 <sup>6</sup>	3.65 <sup>6</sup>	2.94 <sup>6</sup>	2.22 <sup>6</sup>	1.50 <sup>3</sup>
		12	6.76	4.93 <sup>7</sup>	4.01 <sup>6</sup>	3.10 <sup>6</sup>	2.19 <sup>3</sup>	1.27 <sup>3</sup>	0.36 <sup>2</sup>		
		14	5.47	3.36 <sup>6</sup>	2.30 <sup>3</sup>	1.24 <sup>3</sup>	0.18 <sup>2</sup>				
		16	4.22 <sup>6</sup>	1.95 <sup>3</sup>	0.82 <sup>2</sup>						
	6	8	8.91	7.51	6.81	6.11	5.41	4.71 <sup>7</sup>	4.01 <sup>6</sup>	3.31 <sup>6</sup>	2.61 <sup>6</sup>
		9	8.28	6.60	5.76	4.92 <sup>7</sup>	4.08 <sup>6</sup>	3.24 <sup>6</sup>	2.40 <sup>6</sup>	1.56 <sup>6</sup>	0.72 <sup>3</sup>
		10	7.70	5.72	4.73 <sup>7</sup>	3.74 <sup>6</sup>	2.76 <sup>6</sup>	1.77 <sup>3</sup>	0.78 <sup>3</sup>		
		12	6.41	3.90 <sup>6</sup>	2.64 <sup>3</sup>	1.39 <sup>3</sup>	0.13 <sup>2</sup>				
		14	5.08 <sup>7</sup>	2.16 <sup>3</sup>	0.71 <sup>2</sup>						
		16	3.80 <sup>6</sup>	0.68 <sup>2</sup>							
	8	8	8.72	6.94	6.05	5.16	4.27 <sup>7</sup>	3.38 <sup>6</sup>	2.49 <sup>6</sup>	1.60 <sup>6</sup>	0.71 <sup>6</sup>
		9	8.05	5.91	4.84 <sup>7</sup>	3.77 <sup>6</sup>	2.70 <sup>6</sup>	1.63 <sup>6</sup>	0.56 <sup>3</sup>		
		10	7.43	4.91 <sup>7</sup>	3.65 <sup>6</sup>	2.40 <sup>6</sup>	1.14 <sup>3</sup>				
		12	6.07	2.87 <sup>6</sup>	1.27 <sup>3</sup>						
		14	4.68 <sup>6</sup>	0.97 <sup>2</sup>							
		16									
10	8	8.53	6.37	5.29	4.20 <sup>7</sup>	3.12 <sup>6</sup>	2.04 <sup>6</sup>	0.96 <sup>6</sup>			
	9	7.82	5.22 <sup>7</sup>	3.93 <sup>6</sup>	2.63 <sup>6</sup>	1.33 <sup>3</sup>	0.03 <sup>3</sup>				
	10	7.16	4.10 <sup>6</sup>	2.58 <sup>6</sup>	1.05 <sup>3</sup>						
	12	5.73 <sup>7</sup>	1.84 <sup>3</sup>								
400JAM250-43, 50ksi	4	8	5.19	4.19	3.70	3.20	2.70 <sup>7</sup>	2.20 <sup>6</sup>	1.70 <sup>6</sup>	1.21 <sup>6</sup>	0.71 <sup>6</sup>
		9	4.86	3.65	3.04	2.44 <sup>6</sup>	1.83 <sup>6</sup>	1.23 <sup>6</sup>	0.62 <sup>6</sup>	0.02 <sup>3</sup>	
		10	4.49	3.06 <sup>7</sup>	2.35 <sup>6</sup>	1.64 <sup>6</sup>	0.93 <sup>3</sup>	0.22 <sup>3</sup>			
		12	3.69	1.88 <sup>6</sup>	0.98 <sup>3</sup>	0.07 <sup>3</sup>					
	6	8	5.00	3.63	2.95	2.26 <sup>7</sup>	1.58 <sup>6</sup>	0.90 <sup>6</sup>	0.21 <sup>6</sup>		
		9	4.63	2.97 <sup>7</sup>	2.14 <sup>6</sup>	1.30 <sup>6</sup>	0.47 <sup>3</sup>				
		10	4.22	2.27 <sup>6</sup>	1.29 <sup>6</sup>	0.31 <sup>3</sup>					
		12	3.35 <sup>7</sup>	0.86 <sup>3</sup>							
	8	8	4.82	3.07	2.20 <sup>6</sup>	1.33 <sup>6</sup>	0.46 <sup>6</sup>				
		9	4.41	2.29 <sup>6</sup>	1.23 <sup>6</sup>	0.17 <sup>3</sup>					
		10	3.95	1.47 <sup>6</sup>	0.22 <sup>3</sup>						
	10	8	4.63	2.51 <sup>7</sup>	1.46 <sup>6</sup>	0.40 <sup>6</sup>					
9		4.18	1.61 <sup>6</sup>	0.32 <sup>3</sup>							
10	3.69 <sup>7</sup>	0.67 <sup>3</sup>									
400JAM250-54, 50ksi	4	8	7.10	6.08	5.57	5.06	4.55	4.04	3.54 <sup>7</sup>	3.03 <sup>6</sup>	2.52 <sup>6</sup>
		9	6.72	5.48	4.86	4.23	3.61 <sup>7</sup>	2.99 <sup>6</sup>	2.37 <sup>6</sup>	1.75 <sup>6</sup>	1.13 <sup>6</sup>
		10	6.25	4.79	4.06 <sup>7</sup>	3.33 <sup>6</sup>	2.60 <sup>6</sup>	1.87 <sup>6</sup>	1.14 <sup>3</sup>	0.41 <sup>3</sup>	
		12	5.12	3.31 <sup>6</sup>	2.40 <sup>6</sup>	1.49 <sup>3</sup>	0.58 <sup>3</sup>				
		14	4.00 <sup>7</sup>	1.94 <sup>3</sup>	0.91 <sup>3</sup>						
		16	3.06 <sup>6</sup>	0.82 <sup>2</sup>							
	6	8	6.90	5.51	4.81	4.11	3.41 <sup>7</sup>	2.71 <sup>6</sup>	2.01 <sup>6</sup>	1.31 <sup>6</sup>	0.61 <sup>6</sup>
		9	6.49	4.78	3.92 <sup>7</sup>	3.07 <sup>6</sup>	2.21 <sup>6</sup>	1.36 <sup>6</sup>	0.51 <sup>3</sup>		
		10	5.98	3.97 <sup>7</sup>	2.97 <sup>6</sup>	1.97 <sup>6</sup>	0.96 <sup>3</sup>				
		12	4.78	2.29 <sup>6</sup>	1.04 <sup>3</sup>						
		14	3.61 <sup>6</sup>	0.78 <sup>2</sup>							
	8	8	6.71	4.93	4.04	3.15 <sup>6</sup>	2.26 <sup>6</sup>	1.37 <sup>6</sup>	0.48 <sup>6</sup>		
		9	6.25	4.08 <sup>7</sup>	2.99 <sup>6</sup>	1.90 <sup>6</sup>	0.82 <sup>3</sup>				
		10	5.70	3.15 <sup>6</sup>	1.87 <sup>6</sup>	0.60 <sup>3</sup>					
		12	4.44 <sup>7</sup>	1.26 <sup>3</sup>							
	10	8	6.52	4.36	3.28 <sup>7</sup>	2.20 <sup>6</sup>	1.12 <sup>6</sup>	0.04 <sup>3</sup>			
9		6.02	3.38 <sup>6</sup>	2.06 <sup>6</sup>	0.74 <sup>3</sup>						
10		5.43	2.33 <sup>6</sup>	0.78 <sup>3</sup>							
12		4.10 <sup>6</sup>	0.24 <sup>3</sup>								

Refer to Important Table Notes on Page 17

JamStud® Allowable Axial Loads for Load Bearing Openings											
Section	Opening Width (ft)	Wall Height (ft)	Lateral Wind Pressure (psf)								
			5	15	20	25	30	35	40	45	50
400JAM250-68, 50ksi	4	8	9.67	8.65	8.15	7.64	7.13	6.62	6.12	5.61	5.10 <sup>7</sup>
		9	9.04	7.82	7.21	6.60	5.99	5.38 <sup>7</sup>	4.77 <sup>6</sup>	4.16 <sup>6</sup>	3.56 <sup>6</sup>
		10	8.36	6.94	6.24	5.53 <sup>7</sup>	4.82 <sup>6</sup>	4.12 <sup>6</sup>	3.41 <sup>6</sup>	2.71 <sup>6</sup>	2.00 <sup>3</sup>
		12	6.90	5.16 <sup>7</sup>	4.28 <sup>6</sup>	3.41 <sup>6</sup>	2.54 <sup>3</sup>	1.67 <sup>3</sup>	0.79 <sup>3</sup>		
		14	5.41	3.46 <sup>6</sup>	2.48 <sup>3</sup>	1.51 <sup>3</sup>	0.53 <sup>2</sup>				
	6	8	9.48	8.08	7.39	6.69	5.99	5.29 <sup>7</sup>	4.59 <sup>6</sup>	3.90 <sup>6</sup>	3.20 <sup>6</sup>
		9	8.81	7.13	6.30	5.46 <sup>7</sup>	4.62 <sup>6</sup>	3.78 <sup>6</sup>	2.95 <sup>6</sup>	2.11 <sup>6</sup>	1.27 <sup>3</sup>
		10	8.09	6.15	5.18 <sup>7</sup>	4.21 <sup>6</sup>	3.24 <sup>6</sup>	2.26 <sup>3</sup>	1.29 <sup>3</sup>	0.32 <sup>3</sup>	
		12	6.58	4.18 <sup>6</sup>	2.98 <sup>3</sup>	1.78 <sup>3</sup>	0.58 <sup>2</sup>				
		14	5.04 <sup>7</sup>	2.36 <sup>3</sup>	1.02 <sup>2</sup>						
	8	8	9.29	7.51	6.62	5.74	4.85 <sup>7</sup>	3.96 <sup>6</sup>	3.07 <sup>6</sup>	2.18 <sup>6</sup>	1.29 <sup>6</sup>
		9	8.58	6.45	5.38 <sup>7</sup>	4.32 <sup>6</sup>	3.25 <sup>6</sup>	2.19 <sup>6</sup>	1.12 <sup>3</sup>	0.06 <sup>3</sup>	
		10	7.83	5.35 <sup>7</sup>	4.12 <sup>6</sup>	2.88 <sup>6</sup>	1.65 <sup>3</sup>	0.41 <sup>3</sup>			
		12	6.25	3.19 <sup>6</sup>	1.67 <sup>3</sup>	0.14 <sup>2</sup>					
		14	4.68 <sup>6</sup>	1.26 <sup>2</sup>							
	10	8	9.10	6.94	5.86	4.78 <sup>7</sup>	3.70 <sup>6</sup>	2.63 <sup>6</sup>	1.55 <sup>6</sup>	0.47 <sup>3</sup>	
		9	8.35	5.76 <sup>7</sup>	4.47 <sup>6</sup>	3.18 <sup>6</sup>	1.88 <sup>3</sup>	0.59 <sup>3</sup>			
		10	7.56	4.56 <sup>6</sup>	3.06 <sup>6</sup>	1.56 <sup>3</sup>	0.06 <sup>3</sup>				
		12	5.92 <sup>7</sup>	2.21 <sup>3</sup>	0.36 <sup>2</sup>						
		14	4.31 <sup>6</sup>	0.17 <sup>2</sup>							
400JAM250-97, 50ksi	4	8	14.25	13.32	12.85	12.39	11.92	11.45	10.99	10.52	10.06
		9	13.31	12.20	11.64	11.09	10.53	9.98	9.42	8.86 <sup>7</sup>	8.31 <sup>7</sup>
		10	12.30	11.02	10.38	9.74	9.10	8.46 <sup>7</sup>	7.82 <sup>6</sup>	7.18 <sup>6</sup>	6.54 <sup>6</sup>
		12	10.20	8.63	7.85 <sup>7</sup>	7.07 <sup>6</sup>	6.29 <sup>6</sup>	5.50 <sup>6</sup>	4.72 <sup>3</sup>	3.94 <sup>3</sup>	3.16 <sup>3</sup>
		14	8.10	6.36 <sup>6</sup>	5.49 <sup>6</sup>	4.62 <sup>3</sup>	3.75 <sup>3</sup>	2.88 <sup>2</sup>	2.01 <sup>2</sup>	1.14 <sup>2</sup>	0.27 <sup>2</sup>
	6	8	14.07	12.79	12.15	11.51	10.87	10.23	9.59	8.95	8.31 <sup>7</sup>
		9	13.10	11.57	10.81	10.05	9.28	8.52 <sup>7</sup>	7.75 <sup>6</sup>	6.99 <sup>6</sup>	6.23 <sup>6</sup>
		10	12.06	10.30	9.42	8.54 <sup>7</sup>	7.66 <sup>6</sup>	6.78 <sup>6</sup>	5.90 <sup>6</sup>	5.02 <sup>6</sup>	4.14 <sup>3</sup>
		12	9.90	7.75 <sup>7</sup>	6.68 <sup>6</sup>	5.60 <sup>6</sup>	4.53 <sup>3</sup>	3.45 <sup>3</sup>	2.38 <sup>3</sup>	1.30 <sup>2</sup>	0.22 <sup>2</sup>
		14	7.78	5.38 <sup>6</sup>	4.19 <sup>3</sup>	2.99 <sup>3</sup>	1.79 <sup>2</sup>	0.60 <sup>2</sup>			
	8	8	13.90	12.27	11.45	10.64	9.82	9.01	8.19 <sup>7</sup>	7.38 <sup>6</sup>	6.56 <sup>6</sup>
		9	12.89	10.95	9.98	9.00	8.03 <sup>7</sup>	7.06 <sup>6</sup>	6.09 <sup>6</sup>	5.11 <sup>6</sup>	4.14 <sup>6</sup>
		10	11.82	9.58	8.46 <sup>7</sup>	7.34 <sup>6</sup>	6.22 <sup>6</sup>	5.10 <sup>6</sup>	3.98 <sup>3</sup>	2.86 <sup>3</sup>	1.74 <sup>3</sup>
		12	9.61	6.87 <sup>6</sup>	5.50 <sup>6</sup>	4.14 <sup>3</sup>	2.77 <sup>3</sup>	1.40 <sup>2</sup>	0.03 <sup>2</sup>		
		14	7.45 <sup>7</sup>	4.40 <sup>3</sup>	2.88 <sup>2</sup>	1.36 <sup>2</sup>					
	10	8	13.73	11.75	10.76	9.77	8.78 <sup>7</sup>	7.79 <sup>7</sup>	6.80 <sup>6</sup>	5.81 <sup>6</sup>	4.82 <sup>6</sup>
		9	12.68	10.32	9.14	7.96 <sup>6</sup>	6.78 <sup>6</sup>	5.60 <sup>6</sup>	4.42 <sup>6</sup>	3.24 <sup>3</sup>	2.06 <sup>3</sup>
		10	11.58	8.86	7.50 <sup>6</sup>	6.14 <sup>6</sup>	4.78 <sup>6</sup>	3.42 <sup>3</sup>	2.06 <sup>3</sup>	0.70 <sup>3</sup>	
		12	9.32	5.99 <sup>6</sup>	4.33 <sup>3</sup>	2.67 <sup>3</sup>	1.01 <sup>2</sup>				
		14	7.12 <sup>6</sup>	3.43 <sup>3</sup>	1.58 <sup>2</sup>						
400JAM350-68, 50ksi	4	8	10.10	9.10	8.60	8.11	7.61	7.11	6.61	6.11	5.61
		9	9.59	8.37	7.77	7.16	6.55	5.95	5.34 <sup>7</sup>	4.73 <sup>7</sup>	4.12 <sup>6</sup>
		10	9.03	7.60	6.88	6.16	5.45 <sup>7</sup>	4.73 <sup>6</sup>	4.02 <sup>6</sup>	3.30 <sup>6</sup>	2.58 <sup>6</sup>
		12	7.93	6.05	5.11 <sup>6</sup>	4.18 <sup>6</sup>	3.24 <sup>6</sup>	2.30 <sup>3</sup>	1.36 <sup>3</sup>	0.42 <sup>3</sup>	
		14	6.66	4.42 <sup>5</sup>	3.30 <sup>6</sup>	2.17 <sup>3</sup>	1.05 <sup>3</sup>				
	6	8	9.91	8.54	7.86	7.17	6.49	5.80	5.11	4.43 <sup>7</sup>	3.74 <sup>6</sup>
		9	9.36	7.69	6.86	6.02	5.19 <sup>7</sup>	4.35 <sup>6</sup>	3.52 <sup>6</sup>	2.68 <sup>6</sup>	1.85 <sup>6</sup>
		10	8.76	6.79	5.81	4.82 <sup>6</sup>	3.84 <sup>6</sup>	2.85 <sup>6</sup>	1.87 <sup>6</sup>	0.88 <sup>3</sup>	
		12	7.58	5.00 <sup>6</sup>	3.71 <sup>6</sup>	2.41 <sup>3</sup>	1.12 <sup>3</sup>				
		14	6.24	3.16 <sup>6</sup>	1.61 <sup>3</sup>	0.07 <sup>2</sup>					
	8	8	9.73	7.98	7.11	6.24	5.36	4.49 <sup>7</sup>	3.62 <sup>6</sup>	2.75 <sup>6</sup>	1.87 <sup>6</sup>
		9	9.13	7.01	5.95	4.88 <sup>7</sup>	3.82 <sup>6</sup>	2.76 <sup>6</sup>	1.70 <sup>6</sup>	0.63 <sup>3</sup>	
		10	8.49	5.99	4.73 <sup>6</sup>	3.48 <sup>6</sup>	2.22 <sup>6</sup>	0.97 <sup>3</sup>			
		12	7.23	3.94 <sup>6</sup>	2.30 <sup>3</sup>	0.65 <sup>3</sup>					
		14	5.82 <sup>7</sup>	1.89 <sup>3</sup>							
	10	8	9.54	7.42	6.36	5.30	4.24 <sup>7</sup>	3.18 <sup>6</sup>	2.12 <sup>6</sup>	1.06 <sup>6</sup>	
		9	8.90	6.32	5.04 <sup>7</sup>	3.75 <sup>6</sup>	2.46 <sup>6</sup>	1.17 <sup>6</sup>			
		10	8.22	5.18 <sup>7</sup>	3.66 <sup>6</sup>	2.13 <sup>6</sup>	0.61 <sup>3</sup>				
		12	6.87	2.88 <sup>6</sup>	0.89 <sup>3</sup>						
		14	5.40 <sup>6</sup>	0.63 <sup>2</sup>							

Refer to Important Table Notes on Page 17

JamStud® Allowable Axial Loads for Load Bearing Openings											
Section	Opening Width (ft)	Wall Height (ft)	Lateral Wind Pressure (psf)								
			5	15	20	25	30	35	40	45	50
400JAM350-97, 50ksi	4	8	16.74	15.74	15.24	14.74	14.24	13.74	13.24	12.74	12.24
		9	15.84	14.63	14.03	13.42	12.82	12.21	11.61	11.00	10.40
		10	14.90	13.49	12.78	12.07	11.36	10.65	9.94	9.24 <sup>7</sup>	8.53 <sup>6</sup>
		12	12.89	11.09	10.19	9.29 <sup>7</sup>	8.38 <sup>6</sup>	7.48 <sup>6</sup>	6.58 <sup>6</sup>	5.68 <sup>6</sup>	4.78 <sup>3</sup>
		14	10.39	8.36 <sup>7</sup>	7.35 <sup>6</sup>	6.33 <sup>6</sup>	5.32 <sup>3</sup>	4.30 <sup>3</sup>	3.29 <sup>3</sup>	2.28 <sup>2</sup>	1.26 <sup>2</sup>
	6	8	16.55	15.18	14.49	13.80	13.11	12.4 <sup>2</sup>	11.74	11.05	10.36
		9	15.61	13.95	13.12	12.29	11.46	10.63	9.80	8.96 <sup>7</sup>	8.13 <sup>6</sup>
		10	14.64	12.69	11.72	10.74	9.77 <sup>7</sup>	8.79 <sup>7</sup>	7.82 <sup>6</sup>	6.85 <sup>6</sup>	5.87 <sup>6</sup>
		12	12.55	10.07	8.84 <sup>7</sup>	7.60 <sup>6</sup>	6.36 <sup>6</sup>	5.12 <sup>3</sup>	3.88 <sup>3</sup>	2.64 <sup>3</sup>	1.40 <sup>3</sup>
		14	10.01	7.22 <sup>6</sup>	5.83 <sup>6</sup>	4.43 <sup>3</sup>	3.04 <sup>3</sup>	1.64 <sup>2</sup>	0.25 <sup>2</sup>		
	8	8	16.37	14.61	13.74	12.86	11.99	11.11	10.23	9.36	8.48 <sup>7</sup>
		9	15.39	13.27	12.21	11.16	10.10	9.04 <sup>7</sup>	7.98 <sup>6</sup>	6.93 <sup>6</sup>	5.87 <sup>6</sup>
		10	14.37	11.89	10.65	9.41 <sup>7</sup>	8.17 <sup>6</sup>	6.93 <sup>6</sup>	5.69 <sup>6</sup>	4.45 <sup>6</sup>	3.22 <sup>3</sup>
		12	12.21	9.06 <sup>7</sup>	7.48 <sup>6</sup>	5.91 <sup>6</sup>	4.33 <sup>3</sup>	2.75 <sup>3</sup>	1.18 <sup>3</sup>		
		14	9.63	6.08 <sup>6</sup>	4.30 <sup>3</sup>	2.53 <sup>3</sup>	0.75 <sup>2</sup>				
	10	8	16.18	14.05	12.99	11.92	10.86	9.80	8.73 <sup>7</sup>	7.67 <sup>6</sup>	6.60 <sup>6</sup>
		9	15.16	12.59	11.31	10.02	8.74 <sup>7</sup>	7.45 <sup>6</sup>	6.17 <sup>6</sup>	4.89 <sup>6</sup>	3.60 <sup>6</sup>
		10	14.11	11.10	9.59 <sup>7</sup>	8.09 <sup>6</sup>	6.58 <sup>6</sup>	5.07 <sup>6</sup>	3.57 <sup>3</sup>	2.06 <sup>3</sup>	0.56 <sup>3</sup>
		12	11.88	8.05 <sup>6</sup>	6.13 <sup>6</sup>	4.22 <sup>3</sup>	2.30 <sup>3</sup>	0.39 <sup>2</sup>			
		14	9.25 <sup>7</sup>	4.94 <sup>3</sup>	2.78 <sup>3</sup>	0.63 <sup>2</sup>					
400JAM350-118, 50ksi	4	8	21.68	20.71	20.22	19.74	19.25	18.77	18.28	17.80	17.32
		9	20.32	19.17	18.59	18.01	17.43	16.85	16.27	15.69	15.12
		10	18.88	17.55	16.88	16.21	15.54	14.87	14.21	13.54	12.87 <sup>7</sup>
		12	15.87	14.22	13.40	12.58	11.76 <sup>7</sup>	10.94 <sup>6</sup>	10.12 <sup>6</sup>	9.30 <sup>6</sup>	8.47 <sup>6</sup>
		14	12.84	10.99	10.07 <sup>7</sup>	9.15 <sup>6</sup>	8.23 <sup>6</sup>	7.31 <sup>6</sup>	6.38 <sup>3</sup>	5.46 <sup>3</sup>	4.54 <sup>3</sup>
	6	8	21.50	20.16	19.50	18.83	18.16	17.50	16.83	16.16	15.50
		9	20.11	18.52	17.72	16.92	16.13	15.33	14.54	13.74	12.95 <sup>7</sup>
		10	18.63	16.79	15.88	14.96	14.04	13.12	12.20 <sup>7</sup>	11.28 <sup>6</sup>	10.36 <sup>6</sup>
		12	15.56	13.30	12.17	11.04 <sup>6</sup>	9.91 <sup>6</sup>	8.78 <sup>6</sup>	7.65 <sup>6</sup>	6.52 <sup>3</sup>	5.39 <sup>3</sup>
		14	12.49	9.96 <sup>7</sup>	8.69 <sup>6</sup>	7.42 <sup>6</sup>	6.15 <sup>3</sup>	4.89 <sup>3</sup>	3.62 <sup>2</sup>	2.35 <sup>2</sup>	1.08 <sup>2</sup>
	8	8	21.31	19.62	18.77	17.92	17.07	16.22	15.38	14.53	13.68
		9	19.89	17.86	16.85	15.84	14.83	13.81	12.80 <sup>7</sup>	11.79 <sup>7</sup>	10.78 <sup>6</sup>
		10	18.38	16.04	14.87	13.70	12.54 <sup>7</sup>	11.37 <sup>6</sup>	10.20 <sup>6</sup>	9.03 <sup>6</sup>	7.86 <sup>6</sup>
		12	15.25	12.38	10.94 <sup>6</sup>	9.50 <sup>6</sup>	8.06 <sup>6</sup>	6.63 <sup>3</sup>	5.19 <sup>3</sup>	3.75 <sup>3</sup>	2.31 <sup>2</sup>
		14	12.14	8.92 <sup>6</sup>	7.31 <sup>6</sup>	5.69 <sup>3</sup>	4.08 <sup>3</sup>	2.47 <sup>2</sup>	0.85 <sup>2</sup>		
	10	8	21.13	19.07	18.04	17.01	15.98	14.95	13.92	12.89	11.86 <sup>7</sup>
		9	19.67	17.21	15.98	14.75	13.52	12.30 <sup>7</sup>	11.07 <sup>6</sup>	9.84 <sup>6</sup>	8.61 <sup>6</sup>
		10	18.13	15.29	13.87	12.45 <sup>7</sup>	11.03 <sup>6</sup>	9.61 <sup>6</sup>	8.19 <sup>6</sup>	6.77 <sup>6</sup>	5.35 <sup>3</sup>
		12	14.94	11.45 <sup>7</sup>	9.71 <sup>6</sup>	7.96 <sup>6</sup>	6.22 <sup>3</sup>	4.47 <sup>3</sup>	2.73 <sup>3</sup>	0.98 <sup>2</sup>	
		14	11.80	7.88 <sup>6</sup>	5.92 <sup>3</sup>	3.96 <sup>3</sup>	2.01 <sup>2</sup>	0.05 <sup>2</sup>			
550JAM250-43, 50ksi	4	8	6.22	5.41	5.01	4.60	4.20	3.79	3.39	2.98	2.58
		9	6.02	5.01	4.50	4.00	3.50	2.99	2.49	1.98 <sup>7</sup>	1.48 <sup>7</sup>
		10	5.78	4.56	3.95	3.34	2.73	2.12 <sup>7</sup>	1.51 <sup>6</sup>	0.90 <sup>6</sup>	0.29 <sup>6</sup>
		12	5.24	3.57	2.74 <sup>7</sup>	1.90 <sup>6</sup>	1.07 <sup>6</sup>	0.23 <sup>6</sup>			
		14	4.63	2.50 <sup>6</sup>	1.43 <sup>6</sup>	0.37 <sup>3</sup>					
	6	8	6.07	4.96	4.40	3.84	3.29	2.73	2.17	1.62 <sup>7</sup>	1.06 <sup>7</sup>
		9	5.83	4.44	3.75	3.05	2.36	1.67 <sup>7</sup>	0.97 <sup>6</sup>	0.28 <sup>6</sup>	
		10	5.55	3.87	3.04	2.20 <sup>7</sup>	1.36 <sup>6</sup>	0.52 <sup>6</sup>			
		12	4.93	2.63 <sup>7</sup>	1.48 <sup>6</sup>	0.33 <sup>6</sup>					
		14	4.23	1.30 <sup>6</sup>							
	8	8	5.92	4.50	3.79	3.09	2.38	1.67 <sup>7</sup>	0.96 <sup>7</sup>	0.25 <sup>6</sup>	
		9	5.64	3.87	2.99	2.11 <sup>7</sup>	1.23 <sup>6</sup>	0.34 <sup>6</sup>			
		10	5.32	3.19	2.12 <sup>7</sup>	1.05 <sup>6</sup>					
		12	4.62	1.69 <sup>6</sup>	0.23 <sup>6</sup>						
		14	3.83 <sup>7</sup>	0.10 <sup>3</sup>							
	10	8	5.77	4.05	3.19	2.33	1.47 <sup>7</sup>	0.60 <sup>6</sup>			
		9	5.45	3.31	2.23	1.16 <sup>6</sup>	0.09 <sup>6</sup>				
		10	5.10	2.50 <sup>7</sup>	1.21 <sup>6</sup>						
			12	4.30	0.75 <sup>6</sup>						

Refer to Important Table Notes on Page 17

JamStud® Allowable Axial Loads for Load Bearing Openings											
Section	Opening Width (ft)	Wall Height (ft)	Lateral Wind Pressure (psf)								
			5	15	20	25	30	35	40	45	50
550JAM250-54, 50ksi	4	8	8.33	7.55	7.16	6.77	6.38	5.99	5.60	5.21	4.82
		9	8.08	7.11	6.63	6.14	5.66	5.17	4.68	4.20	3.71
		10	7.80	6.63	6.04	5.46	4.87	4.28	3.69 <sup>7</sup>	3.11 <sup>7</sup>	2.52 <sup>5</sup>
		12	7.24	5.62	4.81	4.00 <sup>7</sup>	3.18 <sup>6</sup>	2.37 <sup>6</sup>	1.56 <sup>6</sup>	0.75 <sup>3</sup>	
		14	6.62	4.52 <sup>7</sup>	3.47 <sup>6</sup>	2.41 <sup>6</sup>	1.36 <sup>3</sup>	0.31 <sup>3</sup>			
	6	8	8.18	7.11	6.57	6.04	5.50	4.96	4.43	3.89	3.35
		9	7.90	6.57	5.90	5.23	4.56	3.90	3.23 <sup>7</sup>	2.56 <sup>7</sup>	1.89 <sup>5</sup>
		10	7.58	5.97	5.16	4.35	3.55 <sup>7</sup>	2.74 <sup>6</sup>	1.93 <sup>6</sup>	1.13 <sup>6</sup>	0.32 <sup>6</sup>
		12	6.94	4.71	3.59 <sup>6</sup>	2.47 <sup>6</sup>	1.36 <sup>6</sup>	0.24 <sup>3</sup>			
		14	6.23	3.33 <sup>6</sup>	1.89 <sup>6</sup>	0.44 <sup>3</sup>					
	8	8	8.04	6.67	5.99	5.30	4.62	3.94	3.25	2.57 <sup>7</sup>	1.89 <sup>7</sup>
		9	7.72	6.02	5.17	4.32	3.47	2.62 <sup>7</sup>	1.77 <sup>6</sup>	0.92 <sup>6</sup>	0.07 <sup>6</sup>
		10	7.36	5.31	4.28	3.25 <sup>7</sup>	2.23 <sup>6</sup>	1.20 <sup>6</sup>	0.17 <sup>6</sup>		
		12	6.63	3.79 <sup>7</sup>	2.37 <sup>6</sup>	0.95 <sup>6</sup>					
		14	5.83	2.15 <sup>6</sup>	0.31 <sup>3</sup>						
	10	8	7.89	6.23	5.40	4.57	3.74	2.91	2.08 <sup>7</sup>	1.25 <sup>6</sup>	0.42 <sup>5</sup>
		9	7.54	5.47	4.44	3.41	2.38 <sup>7</sup>	1.35 <sup>6</sup>	0.31 <sup>6</sup>		
		10	7.14	4.65	3.40 <sup>7</sup>	2.15 <sup>6</sup>	0.91 <sup>6</sup>				
		12	6.33	2.88 <sup>6</sup>	1.16 <sup>6</sup>						
		14	5.44 <sup>7</sup>	0.97 <sup>3</sup>							
550JAM250-68, 50ksi	4	8	12.05	11.23	10.82	10.41	10.00	9.59	9.18	8.77	8.36
		9	11.76	10.74	10.23	9.71	9.20	8.69	8.18	7.67	7.16
		10	11.43	10.19	9.58	8.96	8.34	7.72	7.10	6.48	5.86 <sup>7</sup>
		12	10.43	8.76	7.93	7.10	6.26 <sup>7</sup>	5.43 <sup>6</sup>	4.60 <sup>6</sup>	3.77 <sup>6</sup>	2.93 <sup>6</sup>
		14	9.25	7.18	6.15 <sup>7</sup>	5.11 <sup>6</sup>	4.08 <sup>6</sup>	3.04 <sup>6</sup>	2.01 <sup>3</sup>	0.97 <sup>3</sup>	
	6	8	11.89	10.77	10.20	9.64	9.08	8.52	7.95	7.39	6.83
		9	11.56	10.16	9.46	8.76	8.06	7.36	6.65	5.95	5.25 <sup>7</sup>
		10	11.20	9.50	8.65	7.80	6.95	6.10	5.24 <sup>7</sup>	4.39 <sup>6</sup>	3.54 <sup>6</sup>
		12	10.11	7.82	6.68	5.54 <sup>6</sup>	4.39 <sup>6</sup>	3.25 <sup>6</sup>	2.10 <sup>6</sup>	0.96 <sup>3</sup>	
		14	8.87	6.02 <sup>7</sup>	4.59 <sup>6</sup>	3.17 <sup>6</sup>	1.75 <sup>3</sup>	0.32 <sup>3</sup>			
	8	8	11.74	10.31	9.59	8.87	8.16	7.44	6.73	6.01	5.29
		9	11.37	9.59	8.69	7.80	6.91	6.02	5.12 <sup>7</sup>	4.23 <sup>7</sup>	3.34 <sup>6</sup>
		10	10.97	8.80	7.72	6.64	5.55 <sup>7</sup>	4.47 <sup>6</sup>	3.39 <sup>6</sup>	2.31 <sup>6</sup>	1.22 <sup>6</sup>
		12	9.80	6.89	5.43 <sup>6</sup>	3.97 <sup>6</sup>	2.52 <sup>6</sup>	1.06 <sup>3</sup>			
		14	8.48	4.85 <sup>6</sup>	3.04 <sup>6</sup>	1.23 <sup>3</sup>					
	10	8	11.59	9.85	8.98	8.11	7.24	6.37	5.50	4.63 <sup>7</sup>	3.76 <sup>7</sup>
		9	11.18	9.01	7.93	6.85	5.76	4.68 <sup>7</sup>	3.59 <sup>6</sup>	2.51 <sup>6</sup>	1.43 <sup>6</sup>
		10	10.74	8.11	6.79	5.48 <sup>7</sup>	4.16 <sup>6</sup>	2.85 <sup>6</sup>	1.53 <sup>6</sup>	0.22 <sup>6</sup>	
		12	9.49	5.95 <sup>7</sup>	4.18 <sup>6</sup>	2.41 <sup>6</sup>	0.65 <sup>3</sup>				
		14	8.09	3.69 <sup>6</sup>	1.49 <sup>3</sup>						
550JAM250-97, 50ksi	4	8	19.13	18.38	18.01	17.63	17.26	16.88	16.51	16.13	15.76
		9	18.57	17.65	17.19	16.72	16.26	15.80	15.33	14.87	14.41
		10	17.94	16.83	16.27	15.72	15.16	14.61	14.05	13.50	12.94
		12	16.46	14.97	14.23	13.49	12.74	12.00	11.25 <sup>7</sup>	10.51 <sup>7</sup>	9.77 <sup>6</sup>
		14	14.77	12.92	12.00	11.08 <sup>7</sup>	10.15 <sup>6</sup>	9.23 <sup>6</sup>	8.31 <sup>6</sup>	7.38 <sup>6</sup>	6.46 <sup>3</sup>
	6	8	18.99	17.96	17.44	16.93	16.41	15.90	15.38	14.87	14.35
		9	18.40	17.13	16.49	15.86	15.22	14.58	13.95	13.31	12.67
		10	17.73	16.21	15.44	14.68	13.92	13.15	12.39	11.63	10.86 <sup>7</sup>
		12	16.18	14.14	13.11	12.09	11.07 <sup>7</sup>	10.05 <sup>6</sup>	9.02 <sup>6</sup>	8.00 <sup>6</sup>	6.98 <sup>6</sup>
		14	14.42	11.89	10.62 <sup>7</sup>	9.35 <sup>6</sup>	8.08 <sup>6</sup>	6.81 <sup>6</sup>	5.54 <sup>3</sup>	4.27 <sup>3</sup>	3.00 <sup>3</sup>
	8	8	18.85	17.54	16.88	16.23	15.57	14.91	14.26	13.60	12.95
		9	18.23	16.61	15.80	14.99	14.18	13.37	12.56	11.75	10.94
		10	17.52	15.58	14.61	13.64	12.67	11.69	10.72 <sup>7</sup>	9.75 <sup>7</sup>	8.78 <sup>6</sup>
		12	15.90	13.30	12.00	10.70 <sup>7</sup>	9.40 <sup>6</sup>	8.09 <sup>6</sup>	6.79 <sup>6</sup>	5.49 <sup>3</sup>	4.19 <sup>3</sup>
		14	14.08	10.85 <sup>7</sup>	9.23 <sup>6</sup>	7.62 <sup>6</sup>	6.00 <sup>3</sup>	4.38 <sup>3</sup>	2.77 <sup>3</sup>	1.15 <sup>2</sup>	
	10	8	18.71	17.12	16.32	15.52	14.73	13.93	13.13	12.34	11.54
		9	18.05	16.09	15.10	14.12	13.14	12.15	11.17	10.19 <sup>7</sup>	9.20 <sup>7</sup>
		10	17.32	14.96	13.78	12.60	11.42	10.24 <sup>7</sup>	9.06 <sup>6</sup>	7.88 <sup>6</sup>	6.70 <sup>6</sup>
		12	15.62	12.46	10.88 <sup>7</sup>	9.30 <sup>6</sup>	7.72 <sup>6</sup>	6.14 <sup>6</sup>	4.56 <sup>3</sup>	2.98 <sup>3</sup>	1.40 <sup>3</sup>
		14	13.73	9.81 <sup>6</sup>	7.85 <sup>6</sup>	5.88 <sup>3</sup>	3.92 <sup>3</sup>	1.96 <sup>2</sup>			
16	11.76	7.17 <sup>6</sup>	4.87 <sup>3</sup>	2.58 <sup>2</sup>	0.28 <sup>2</sup>						

Refer to Important Table Notes on Page 17

JamStud® Allowable Axial Loads for Load Bearing Openings												
Section	Opening Width (ft)	Wall Height (ft)	Lateral Wind Pressure (psf)									
			5	15	20	25	30	35	40	45	50	
550JAM250-118, 50ksi	4	8	24.39	23.64	23.27	22.89	22.52	22.15	21.77	21.40	21.02	
		9	23.69	22.77	22.31	21.85	21.38	20.92	20.46	20.00	19.54	
		10	22.89	21.79	21.23	20.68	20.13	19.57	19.02	18.47	17.91	
		12	21.02	19.54	18.81	18.07	17.33	16.59	15.85	15.11	14.37 <sup>7</sup>	
		14	18.89	17.05	16.14	15.22	14.31 <sup>7</sup>	13.39 <sup>7</sup>	12.48 <sup>6</sup>	11.56 <sup>6</sup>	10.64 <sup>6</sup>	
	6	8	24.25	23.22	22.71	22.19	21.68	21.16	20.65	20.14	19.62	
		9	23.52	22.25	21.62	20.98	20.35	19.71	19.08	18.44	17.81	
		10	22.69	21.16	20.40	19.64	18.88	18.12	17.36	16.60	15.84	
		12	20.75	18.71	17.70	16.68	15.66	14.65 <sup>7</sup>	13.63 <sup>7</sup>	12.61 <sup>6</sup>	11.60 <sup>6</sup>	
		14	18.54	16.02	14.77	13.51 <sup>7</sup>	12.25 <sup>6</sup>	10.99 <sup>6</sup>	9.73 <sup>6</sup>	8.47 <sup>3</sup>	7.21 <sup>3</sup>	
	8	8	24.11	22.80	22.15	21.49	20.84	20.18	19.53	18.87	18.22	
		9	23.35	21.73	20.92	20.11	19.31	18.50	17.69	16.88	16.08	
		10	22.48	20.54	19.57	18.61	17.64	16.67	15.70	14.73	13.76 <sup>7</sup>	
		12	20.47	17.88	16.59	15.29	14.00 <sup>7</sup>	12.70 <sup>6</sup>	11.41 <sup>6</sup>	10.12 <sup>6</sup>	8.82 <sup>6</sup>	
		14	18.20	14.99	13.39 <sup>7</sup>	11.79 <sup>6</sup>	10.19 <sup>6</sup>	8.58 <sup>3</sup>	6.98 <sup>3</sup>	5.38 <sup>3</sup>	3.77 <sup>3</sup>	
	10	8	23.97	22.38	21.58	20.79	20.00	19.20	18.41	17.61	16.82	
		9	23.17	21.21	20.23	19.25	18.27	17.29	16.31	15.33	14.34	
		10	22.27	19.92	18.74	17.57	16.39	15.22	14.04 <sup>7</sup>	12.87 <sup>7</sup>	11.69 <sup>6</sup>	
		12	20.19	17.05	15.48	13.91 <sup>7</sup>	12.33 <sup>6</sup>	10.76 <sup>6</sup>	9.19 <sup>6</sup>	7.62 <sup>3</sup>	6.05 <sup>3</sup>	
		14	17.86	13.96 <sup>7</sup>	12.02 <sup>6</sup>	10.07 <sup>6</sup>	8.13 <sup>3</sup>	6.18 <sup>3</sup>	4.23 <sup>3</sup>	2.29 <sup>2</sup>	0.34 <sup>2</sup>	
	550JAM350-68, 50ksi	4	8	12.31	11.54	11.16	10.78	10.40	10.01	9.63	9.25	8.86
			9	11.99	11.04	10.56	10.09	9.61	9.13	8.66	8.18	7.71
			10	11.63	10.48	9.90	9.33	8.75	8.18	7.60	7.03	6.45
			12	10.80	9.23	8.44	7.66	6.87	6.08 <sup>7</sup>	5.30 <sup>7</sup>	4.51 <sup>6</sup>	3.72 <sup>6</sup>
14			9.86	7.86	6.85	5.85 <sup>7</sup>	4.84 <sup>6</sup>	3.84 <sup>6</sup>	2.84 <sup>6</sup>	1.83 <sup>3</sup>	0.83 <sup>3</sup>	
6		8	12.17	11.11	10.59	10.06	9.53	9.01	8.48	7.95	7.43	
		9	11.81	10.50	9.85	9.19	8.54	7.88	7.23	6.58	5.92	
		10	11.41	9.83	9.04	8.25	7.46	6.67	5.88	5.09 <sup>7</sup>	4.29 <sup>7</sup>	
		12	10.51	8.35	7.26	6.18 <sup>7</sup>	5.10 <sup>6</sup>	4.02 <sup>6</sup>	2.94 <sup>6</sup>	1.85 <sup>6</sup>	0.77 <sup>3</sup>	
		14	9.49	6.73	5.35 <sup>6</sup>	3.96 <sup>6</sup>	2.58 <sup>6</sup>	1.20 <sup>3</sup>				
8		8	12.02	10.68	10.01	9.34	8.67	8.00	7.33	6.66	5.99	
		9	11.63	9.97	9.13	8.30	7.47	6.64	5.80	4.97	4.14 <sup>7</sup>	
		10	11.20	9.18	8.18	7.17	6.16	5.16 <sup>7</sup>	4.15 <sup>6</sup>	3.14 <sup>6</sup>	2.14 <sup>6</sup>	
		12	10.21	7.46	6.08 <sup>7</sup>	4.71 <sup>6</sup>	3.33 <sup>6</sup>	1.95 <sup>6</sup>	0.58 <sup>3</sup>			
		14	9.11	5.60 <sup>6</sup>	3.84 <sup>6</sup>	2.08 <sup>3</sup>	0.32 <sup>3</sup>					
10		8	11.88	10.25	9.44	8.62	7.81	7.00	6.18	5.37	4.56	
		9	11.45	9.43	8.42	7.41	6.40	5.39	4.37 <sup>7</sup>	3.36 <sup>6</sup>	2.35 <sup>6</sup>	
		10	10.98	8.54	7.31	6.09	4.87 <sup>7</sup>	3.65 <sup>6</sup>	2.42 <sup>6</sup>	1.20 <sup>6</sup>		
		12	9.92	6.58	4.90 <sup>6</sup>	3.23 <sup>6</sup>	1.56 <sup>6</sup>					
		14	8.73	4.47 <sup>6</sup>	2.33 <sup>3</sup>	0.20 <sup>3</sup>						
550JAM350-97, 50ksi		4	8	21.81	20.97	20.55	20.13	19.70	19.28	18.86	18.44	18.02
			9	21.31	20.26	19.74	19.22	18.70	18.18	17.65	17.13	16.61
			10	20.62	19.37	18.74	18.11	17.49	16.86	16.23	15.60	14.97
			12	19.09	17.39	16.54	15.69	14.85	14.00	13.15	12.30	11.45 <sup>7</sup>
	14		17.40	15.26	14.19	13.12	12.05	10.99 <sup>7</sup>	9.92 <sup>6</sup>	8.85 <sup>6</sup>	7.78 <sup>6</sup>	
	6	8	21.65	20.49	19.91	19.34	18.76	18.18	17.60	17.03	16.45	
		9	21.11	19.68	18.96	18.24	17.52	16.80	16.09	15.37	14.65	
		10	20.39	18.66	17.80	16.94	16.07	15.21	14.35	13.48	12.62	
		12	18.77	16.44	15.27	14.10	12.94	11.77	10.61 <sup>7</sup>	9.44 <sup>6</sup>	8.27 <sup>6</sup>	
		14	17.00	14.06	12.59	11.12 <sup>7</sup>	9.65 <sup>6</sup>	8.18 <sup>6</sup>	6.71 <sup>6</sup>	5.24 <sup>3</sup>	3.77 <sup>3</sup>	
	8	8	21.49	20.02	19.28	18.55	17.81	17.08	16.34	15.61	14.87	
		9	20.92	19.09	18.18	17.26	16.35	15.43	14.52	13.60	12.69	
		10	20.15	17.96	16.86	15.76	14.66	13.56	12.46	11.36	10.27 <sup>7</sup>	
		12	18.45	15.48	14.00	12.51	11.03 <sup>7</sup>	9.55 <sup>6</sup>	8.06 <sup>6</sup>	6.58 <sup>6</sup>	5.09 <sup>6</sup>	
		14	16.60	12.86	10.99 <sup>7</sup>	9.11 <sup>6</sup>	7.24 <sup>6</sup>	5.37 <sup>3</sup>	3.50 <sup>3</sup>	1.63 <sup>3</sup>		
	10	8	21.33	19.55	18.65	17.76	16.87	15.98	15.08	14.19	13.30	
		9	20.72	18.50	17.39	16.28	15.17	14.06	12.95	11.84	10.73	
		10	19.92	17.25	15.92	14.58	13.25	11.91	10.58 <sup>7</sup>	9.25 <sup>7</sup>	7.91 <sup>6</sup>	
		12	18.13	14.53	12.73	10.92 <sup>7</sup>	9.12 <sup>6</sup>	7.32 <sup>6</sup>	5.52 <sup>6</sup>	3.72 <sup>6</sup>	1.91 <sup>3</sup>	
		14	16.20	11.65 <sup>7</sup>	9.38 <sup>6</sup>	7.11 <sup>6</sup>	4.83 <sup>3</sup>	2.56 <sup>3</sup>	0.29 <sup>3</sup>			
	16	14.25	8.79 <sup>6</sup>	6.06 <sup>3</sup>	3.33 <sup>3</sup>	0.61 <sup>2</sup>						

Refer to Important Table Notes on Page 17

JamStud® Allowable Axial Loads for Load Bearing Openings												
Section	Opening Width (ft)	Wall Height (ft)	Lateral Wind Pressure (psf)									
			5	15	20	25	30	35	40	45	50	
550JAM350-118, 50ksi	4	8	28.61	27.77	27.36	26.94	26.52	26.10	25.68	25.27	24.85	
		9	27.90	26.86	26.34	25.82	25.31	24.79	24.27	23.75	23.23	
		10	27.11	25.86	25.24	24.61	23.99	23.36	22.74	22.11	21.49	
		12	25.37	23.67	22.82	21.97	21.12	20.27	19.42	18.57	17.72	
		14	23.20	21.06	19.99	18.92	17.84	16.77	15.70 <sup>7</sup>	14.63 <sup>6</sup>	13.56 <sup>6</sup>	
	6	8	28.45	27.30	26.73	26.15	25.58	25.00	24.43	23.86	23.28	
		9	27.70	26.28	25.57	24.85	24.14	23.43	22.72	22.00	21.29	
		10	26.87	25.16	24.30	23.44	22.58	21.72	20.87	20.01	19.15	
		12	25.05	22.72	21.55	20.38	19.21	18.04	16.87	15.71 <sup>7</sup>	14.54 <sup>7</sup>	
		14	22.80	19.85	18.38	16.91	15.44 <sup>7</sup>	13.96 <sup>6</sup>	12.49 <sup>6</sup>	11.02 <sup>6</sup>	9.55 <sup>6</sup>	
	8	8	28.30	26.83	26.10	25.37	24.64	23.91	23.18	22.44	21.71	
		9	27.51	25.70	24.79	23.88	22.98	22.07	21.16	20.26	19.35	
		10	26.64	24.45	23.36	22.27	21.18	20.09	18.99	17.90	16.81	
		12	24.73	21.76	20.27	18.79	17.30	15.81 <sup>7</sup>	14.33 <sup>7</sup>	12.84 <sup>6</sup>	11.35 <sup>6</sup>	
		14	22.39	18.65	16.77	14.90 <sup>7</sup>	13.03 <sup>6</sup>	11.15 <sup>6</sup>	9.28 <sup>6</sup>	7.41 <sup>3</sup>	5.54 <sup>3</sup>	
	10	8	28.14	26.36	25.48	24.59	23.70	22.81	21.92	21.03	20.14	
		9	27.31	25.11	24.01	22.91	21.81	20.71	19.61	18.51	17.41	
		10	26.41	23.75	22.43	21.10	19.77	18.45	17.12	15.80	14.47 <sup>7</sup>	
		12	24.42	20.80	19.00	17.19	15.39 <sup>7</sup>	13.58 <sup>6</sup>	11.78 <sup>6</sup>	9.97 <sup>6</sup>	8.16 <sup>6</sup>	
		14	21.99	17.44	15.17 <sup>7</sup>	12.89 <sup>6</sup>	10.62 <sup>6</sup>	8.35 <sup>3</sup>	6.07 <sup>3</sup>	3.80 <sup>3</sup>	1.52 <sup>3</sup>	
600JAM250-43, 50ksi	4	8	6.43	5.67	5.30	4.92	4.54	4.16	3.79	3.41	3.03	
		9	6.25	5.30	4.83	4.36	3.89	3.42	2.94	2.47	2.00	
		10	6.04	4.89	4.32	3.75	3.17	2.60	2.03 <sup>7</sup>	1.45 <sup>7</sup>	0.88 <sup>6</sup>	
		12	5.56	3.97	3.18	2.39 <sup>7</sup>	1.59 <sup>6</sup>	0.80 <sup>6</sup>				
		14	5.00	2.95 <sup>7</sup>	1.93 <sup>6</sup>	0.90 <sup>6</sup>						
	6	8	6.29	5.25	4.73	4.21	3.69	3.17	2.65	2.13	1.61	
		9	6.07	4.77	4.12	3.47	2.83	2.18	1.53 <sup>7</sup>	0.88 <sup>7</sup>	0.23 <sup>6</sup>	
		10	5.83	4.25	3.46	2.67	1.88 <sup>7</sup>	1.09 <sup>6</sup>	0.30 <sup>6</sup>			
		12	5.26	3.08	1.99 <sup>6</sup>	0.90 <sup>6</sup>						
		14	4.62	1.80 <sup>6</sup>	0.39 <sup>6</sup>							
	8	8	6.15	4.82	4.16	3.50	2.84	2.18	1.52	0.86 <sup>7</sup>	0.19 <sup>7</sup>	
		9	5.89	4.24	3.42	2.59	1.76 <sup>7</sup>	0.94 <sup>7</sup>	0.11 <sup>6</sup>			
		10	5.61	3.60	2.60	1.60 <sup>7</sup>	0.59 <sup>6</sup>					
		12	4.97	2.19 <sup>7</sup>	0.80 <sup>6</sup>							
		14	4.24	0.65 <sup>6</sup>								
	10	8	6.01	4.40	3.60	2.79	1.99	1.19 <sup>7</sup>	0.38 <sup>7</sup>			
		9	5.72	3.71	2.71	1.70 <sup>7</sup>	0.70 <sup>6</sup>					
		10	5.40	2.96	1.74 <sup>7</sup>	0.52 <sup>6</sup>						
	600JAM250-54, 50ksi	4	8	8.61	7.88	7.52	7.16	6.79	6.43	6.06	5.70	5.33
			9	8.40	7.49	7.04	6.58	6.13	5.67	5.22	4.76	4.31
10			8.16	7.05	6.50	5.95	5.40	4.84	4.29	3.74	3.18 <sup>7</sup>	
12			7.58	6.06	5.30	4.53	3.77 <sup>7</sup>	3.01 <sup>6</sup>	2.25 <sup>6</sup>	1.48 <sup>6</sup>	0.72 <sup>6</sup>	
14			7.03	5.03	4.03 <sup>7</sup>	3.04 <sup>6</sup>	2.04 <sup>6</sup>	1.04 <sup>3</sup>	0.04 <sup>3</sup>			
6		8	8.48	7.47	6.97	6.47	5.97	5.47	4.97	4.47	3.97	
		9	8.23	6.98	6.35	5.73	5.10	4.48	3.85	3.22	2.60 <sup>7</sup>	
		10	7.95	6.43	5.67	4.91	4.15	3.39 <sup>7</sup>	2.63 <sup>7</sup>	1.87 <sup>6</sup>	1.11 <sup>6</sup>	
		12	7.30	5.20	4.15 <sup>7</sup>	3.10 <sup>6</sup>	2.06 <sup>6</sup>	1.01 <sup>6</sup>				
		14	6.65	3.91 <sup>7</sup>	2.54 <sup>6</sup>	1.16 <sup>6</sup>						
8		8	8.34	7.06	6.43	5.79	5.15	4.51	3.88	3.24	2.60	
		9	8.06	6.47	5.67	4.87	4.08	3.28	2.49 <sup>7</sup>	1.69 <sup>6</sup>	0.89 <sup>6</sup>	
		10	7.74	5.81	4.84	3.88	2.91 <sup>7</sup>	1.94 <sup>6</sup>	0.97 <sup>6</sup>	0.01 <sup>6</sup>		
		12	7.01	4.34	3.01 <sup>6</sup>	1.67 <sup>6</sup>	0.34 <sup>6</sup>					
		14	6.28	2.79 <sup>6</sup>	1.04 <sup>3</sup>							
10		8	8.20	6.65	5.88	5.11	4.33	3.56	2.78	2.01 <sup>7</sup>	1.23 <sup>7</sup>	
		9	7.89	5.96	4.99	4.02	3.05	2.09 <sup>7</sup>	1.12 <sup>6</sup>	0.15 <sup>6</sup>		
		10	7.54	5.19	4.01	2.84 <sup>7</sup>	1.67 <sup>6</sup>	0.49 <sup>6</sup>				
		12	6.73	3.49 <sup>7</sup>	1.87 <sup>6</sup>	0.25 <sup>6</sup>						
14		8	5.90	1.66 <sup>6</sup>								

Refer to Important Table Notes on Page 17

JamStud® Allowable Axial Loads for Load Bearing Openings											
Section	Opening Width (ft)	Wall Height (ft)	Lateral Wind Pressure (psf)								
			5	15	20	25	30	35	40	45	50
600JAM250-68, 50ksi	4	8	12.43	11.67	11.29	10.90	10.52	10.14	9.76	9.38	9.00
		9	12.17	11.22	10.74	10.27	9.79	9.32	8.84	8.37	7.89
		10	11.88	10.73	10.15	9.57	8.99	8.41	7.83	7.25	6.67
		12	11.19	9.59	8.79	7.98	7.18	6.38 <sup>7</sup>	5.58 <sup>7</sup>	4.78 <sup>6</sup>	3.97 <sup>6</sup>
		14	10.13	8.10	7.09	6.07 <sup>7</sup>	5.06 <sup>6</sup>	4.04 <sup>6</sup>	3.03 <sup>5</sup>	2.01 <sup>3</sup>	1.00 <sup>3</sup>
	6	8	12.28	11.24	10.71	10.19	9.67	9.14	8.62	8.10	7.57
		9	11.99	10.69	10.03	9.38	8.72	8.07	7.41	6.76	6.11
		10	11.67	10.07	9.28	8.48	7.69	6.89	6.10	5.30 <sup>7</sup>	4.50 <sup>7</sup>
		12	10.89	8.69	7.58	6.48 <sup>7</sup>	5.38 <sup>6</sup>	4.27 <sup>6</sup>	3.17 <sup>6</sup>	2.07 <sup>6</sup>	0.97 <sup>3</sup>
		14	9.75	6.96	5.56 <sup>6</sup>	4.17 <sup>6</sup>	2.77 <sup>6</sup>	1.38 <sup>3</sup>			
	8	8	12.14	10.81	10.14	9.48	8.81	8.14	7.48	6.81	6.15
		9	11.82	10.15	9.32	8.48	7.65	6.82	5.99	5.15	4.32 <sup>7</sup>
		10	11.45	9.42	8.41	7.40	6.39	5.37 <sup>7</sup>	4.36 <sup>7</sup>	3.35 <sup>6</sup>	2.33 <sup>6</sup>
		12	10.59	7.78	6.38 <sup>7</sup>	4.98 <sup>6</sup>	3.57 <sup>6</sup>	2.17 <sup>6</sup>	0.77 <sup>3</sup>		
		14	9.37	5.82 <sup>6</sup>	4.04 <sup>6</sup>	2.27 <sup>3</sup>	0.49 <sup>3</sup>				
	10	8	12.00	10.38	9.57	8.76	7.95	7.15	6.34	5.53	4.72
		9	11.64	9.61	8.60	7.59	6.58	5.57	4.56 <sup>7</sup>	3.55 <sup>7</sup>	2.54 <sup>6</sup>
		10	11.23	8.77	7.54	6.31	5.08 <sup>7</sup>	3.85 <sup>6</sup>	2.62 <sup>6</sup>	1.39 <sup>6</sup>	0.16 <sup>6</sup>
		12	10.29	6.88	5.18 <sup>6</sup>	3.47 <sup>6</sup>	1.77 <sup>6</sup>	0.06 <sup>3</sup>			
		14	8.99	4.68 <sup>6</sup>	2.52 <sup>6</sup>	0.37 <sup>3</sup>					
600JAM250-97, 50ksi	4	8	20.00	19.29	18.94	18.59	18.24	17.88	17.53	17.18	16.83
		9	19.53	18.66	18.22	17.78	17.35	16.91	16.47	16.03	15.60
		10	18.99	17.94	17.41	16.88	16.36	15.83	15.30	14.77	14.24
		12	17.71	16.27	15.55	14.84	14.12	13.40	12.69	11.97	11.25 <sup>7</sup>
		14	16.19	14.38	13.47	12.57	11.66	10.75 <sup>7</sup>	9.85 <sup>6</sup>	8.94 <sup>6</sup>	8.04 <sup>6</sup>
	6	8	19.86	18.90	18.41	17.93	17.44	16.96	16.48	15.99	15.51
		9	19.37	18.17	17.56	16.96	16.36	15.76	15.16	14.56	13.96
		10	18.80	17.34	16.62	15.89	15.17	14.44	13.72	12.99	12.26
		12	17.44	15.46	14.48	13.49	12.51	11.52 <sup>7</sup>	10.53 <sup>7</sup>	9.55 <sup>6</sup>	8.56 <sup>6</sup>
		14	15.85	13.36	12.11	10.87 <sup>7</sup>	9.62 <sup>6</sup>	8.38 <sup>6</sup>	7.13 <sup>6</sup>	5.88 <sup>3</sup>	4.64 <sup>3</sup>
	8	8	19.73	18.50	17.88	17.27	16.65	16.04	15.42	14.80	14.19
		9	19.20	17.67	16.91	16.14	15.38	14.61	13.85	13.08	12.32
		10	18.60	16.75	15.83	14.90	13.98	13.06	12.13	11.21	10.29 <sup>7</sup>
		12	17.17	14.66	13.40	12.15	10.89 <sup>7</sup>	9.64 <sup>6</sup>	8.38 <sup>6</sup>	7.13 <sup>6</sup>	5.87 <sup>6</sup>
		14	15.51	12.34	10.75 <sup>7</sup>	9.17 <sup>6</sup>	7.58 <sup>6</sup>	6.00 <sup>3</sup>	4.41 <sup>3</sup>	2.83 <sup>3</sup>	1.24 <sup>3</sup>
	10	8	19.60	18.10	17.36	16.61	15.86	15.11	14.36	13.62	12.87
		9	19.04	17.18	16.25	15.32	14.39	13.47	12.54	11.61	10.68
		10	18.40	16.16	15.04	13.91	12.79	11.67	10.55 <sup>7</sup>	9.43 <sup>7</sup>	8.31 <sup>6</sup>
		12	16.90	13.85	12.33	10.80 <sup>7</sup>	9.28 <sup>6</sup>	7.75 <sup>6</sup>	6.23 <sup>6</sup>	4.71 <sup>3</sup>	3.18 <sup>3</sup>
		14	15.17	11.32 <sup>7</sup>	9.40 <sup>6</sup>	7.47 <sup>6</sup>	5.55 <sup>3</sup>	3.62 <sup>3</sup>	1.70 <sup>3</sup>		
600JAM250-118, 50ksi	4	8	25.59	24.90	24.55	24.20	23.85	23.50	23.15	22.81	22.46
		9	25.01	24.15	23.72	23.29	22.85	22.42	21.99	21.56	21.12
		10	24.34	23.30	22.78	22.26	21.73	21.21	20.69	20.17	19.65
		12	22.72	21.31	20.60	19.89	19.19	18.48	17.77	17.06	16.36
		14	20.82	19.03	18.14	17.25	16.36	15.46	14.57 <sup>7</sup>	13.68 <sup>6</sup>	12.79 <sup>6</sup>
	6	8	25.46	24.50	24.02	23.55	23.07	22.59	22.11	21.63	21.15
		9	24.85	23.66	23.07	22.47	21.88	21.29	20.69	20.10	19.50
		10	24.15	22.71	21.99	21.28	20.56	19.84	19.13	18.41	17.69
		12	22.46	20.51	19.54	18.57	17.59	16.62	15.65	14.68 <sup>7</sup>	13.70 <sup>6</sup>
		14	20.48	18.03	16.80	15.57	14.35 <sup>7</sup>	13.12 <sup>6</sup>	11.89 <sup>6</sup>	10.67 <sup>6</sup>	9.44 <sup>6</sup>
	8	8	25.33	24.11	23.50	22.89	22.28	21.67	21.07	20.46	19.85
		9	24.69	23.18	22.42	21.66	20.91	20.15	19.39	18.64	17.88
		10	23.95	22.12	21.21	20.30	19.39	18.48	17.56	16.65	15.74
		12	22.19	19.72	18.48	17.24	16.00	14.76 <sup>7</sup>	13.53 <sup>6</sup>	12.29 <sup>6</sup>	11.05 <sup>6</sup>
		14	20.15	17.02	15.46	13.90 <sup>6</sup>	12.34 <sup>6</sup>	10.78 <sup>6</sup>	9.22 <sup>6</sup>	7.65 <sup>3</sup>	6.09 <sup>3</sup>
	10	8	25.20	23.72	22.98	22.24	21.50	20.76	20.02	19.28	18.54
		9	24.53	22.69	21.77	20.85	19.94	19.02	18.10	17.18	16.26
		10	23.75	21.54	20.43	19.32	18.21	17.11	16.00	14.89	13.78 <sup>7</sup>
		12	21.93	18.92	17.42	15.91	14.41 <sup>7</sup>	12.91 <sup>6</sup>	11.40 <sup>6</sup>	9.90 <sup>6</sup>	8.40 <sup>6</sup>
		14	19.81	16.02	14.12 <sup>7</sup>	12.23 <sup>6</sup>	10.33 <sup>6</sup>	8.44 <sup>3</sup>	6.54 <sup>3</sup>	4.64 <sup>3</sup>	2.75 <sup>3</sup>
16	8	17.53	13.01 <sup>6</sup>	10.75 <sup>6</sup>	8.50 <sup>3</sup>	6.24 <sup>3</sup>	3.98 <sup>2</sup>	1.73 <sup>2</sup>			

Refer to Important Table Notes on Page 17

JamStud® Allowable Axial Loads for Load Bearing Openings											
Section	Opening Width (ft)	Wall Height (ft)	Lateral Wind Pressure (psf)								
			5	15	20	25	30	35	40	45	50
600JAM350-68, 50ksi	4	8	12.74	12.02	11.66	11.30	10.95	10.59	10.23	9.87	9.51
		9	12.46	11.57	11.12	10.67	10.22	9.77	9.32	8.88	8.43
		10	12.15	11.06	10.51	9.97	9.43	8.88	8.34	7.79	7.25
		12	11.41	9.91	9.16	8.41	7.66	6.91	6.16	5.41 <sup>7</sup>	4.65 <sup>5</sup>
		14	10.57	8.63	7.66	6.69	5.72 <sup>7</sup>	4.75 <sup>6</sup>	3.78 <sup>6</sup>	2.81 <sup>6</sup>	1.84 <sup>6</sup>
	6	8	12.61	11.62	11.12	10.63	10.14	9.64	9.15	8.65	8.16
		9	12.29	11.06	10.45	9.83	9.21	8.60	7.98	7.36	6.75
		10	11.94	10.45	9.70	8.95	8.20	7.45	6.71	5.96	5.21
		12	11.13	9.07	8.03	7.00	5.97 <sup>7</sup>	4.94 <sup>7</sup>	3.90 <sup>6</sup>	2.87 <sup>6</sup>	1.84 <sup>6</sup>
		14	10.20	7.54	6.20 <sup>7</sup>	4.87 <sup>5</sup>	3.54 <sup>6</sup>	2.21 <sup>6</sup>	0.87 <sup>3</sup>		
	8	8	12.47	11.21	10.59	9.96	9.33	8.70	8.07	7.44	6.81
		9	12.13	10.56	9.77	8.99	8.20	7.42	6.63	5.85	5.07
		10	11.74	9.83	8.88	7.93	6.98	6.03	5.07	4.12 <sup>7</sup>	3.17 <sup>5</sup>
		12	10.85	8.22	6.91	5.59 <sup>7</sup>	4.28 <sup>6</sup>	2.97 <sup>6</sup>	1.65 <sup>6</sup>	0.34 <sup>6</sup>	
		14	9.84	6.45 <sup>7</sup>	4.75 <sup>5</sup>	3.05 <sup>6</sup>	1.36 <sup>3</sup>				
	10	8	12.34	10.81	10.05	9.28	8.52	7.75	6.99	6.23	5.46
		9	11.96	10.05	9.10	8.15	7.19	6.24	5.29	4.34	3.38 <sup>7</sup>
		10	11.53	9.22	8.07	6.91	5.75	4.60 <sup>7</sup>	3.44 <sup>7</sup>	2.29 <sup>6</sup>	1.13 <sup>6</sup>
		12	10.57	7.38	5.78 <sup>7</sup>	4.19 <sup>6</sup>	2.59 <sup>6</sup>	0.99 <sup>6</sup>			
		14	9.48	5.36 <sup>6</sup>	3.30 <sup>6</sup>	1.24 <sup>3</sup>					
600JAM350-97, 50ksi	4	8	22.56	21.79	21.40	21.01	20.62	20.23	19.85	19.46	19.07
		9	22.16	21.20	20.71	20.23	19.74	19.26	18.77	18.29	17.80
		10	21.71	20.54	19.95	19.36	18.77	18.18	17.59	17.00	16.41
		12	20.39	18.78	17.98	17.17	16.36	15.56	14.75	13.94	13.14
		14	18.84	16.78	15.75	14.72	13.70	12.67	11.64 <sup>7</sup>	10.61 <sup>6</sup>	9.58 <sup>5</sup>
	6	8	22.42	21.35	20.82	20.28	19.75	19.22	18.68	18.15	17.62
		9	21.98	20.65	19.98	19.32	18.65	17.99	17.32	16.65	15.99
		10	21.49	19.87	19.06	18.25	17.44	16.63	15.82	15.01	14.20
		12	20.09	17.87	16.77	15.66	14.55	13.44	12.33	11.22 <sup>7</sup>	10.11 <sup>7</sup>
		14	18.45	15.62	14.21	12.80	11.38 <sup>7</sup>	9.97 <sup>6</sup>	8.55 <sup>6</sup>	7.14 <sup>5</sup>	5.73 <sup>5</sup>
	8	8	22.27	20.91	20.23	19.56	18.88	18.20	17.52	16.84	16.16
		9	21.80	20.11	19.26	18.41	17.56	16.71	15.87	15.02	14.17
		10	21.27	19.21	18.18	17.15	16.12	15.09	14.06	13.03	12.00
		12	19.79	16.97	15.56	14.15	12.74	11.32 <sup>7</sup>	9.91 <sup>7</sup>	8.50 <sup>6</sup>	7.09 <sup>5</sup>
		14	18.07	14.47	12.67	10.87 <sup>7</sup>	9.07 <sup>6</sup>	7.27 <sup>6</sup>	5.47 <sup>6</sup>	3.67 <sup>3</sup>	1.87 <sup>3</sup>
	10	8	22.13	20.48	19.65	18.83	18.00	17.18	16.36	15.53	14.71
		9	21.62	19.56	18.53	17.50	16.47	15.44	14.41	13.38	12.35
		10	21.05	18.55	17.30	16.04	14.79	13.54	12.29	11.04	9.79 <sup>7</sup>
		12	19.49	16.06	14.35	12.63	10.92 <sup>7</sup>	9.21 <sup>6</sup>	7.49 <sup>6</sup>	5.78 <sup>5</sup>	4.07 <sup>5</sup>
		14	17.68	13.31	11.12 <sup>7</sup>	8.94 <sup>6</sup>	6.75 <sup>5</sup>	4.57 <sup>6</sup>	2.38 <sup>3</sup>	0.20 <sup>3</sup>	
600JAM350-118, 50ksi	4	8	29.90	29.12	28.72	28.33	27.93	27.54	27.14	26.75	26.35
		9	29.28	28.30	27.81	27.32	26.83	26.33	25.84	25.35	24.86
		10	28.57	27.39	26.79	26.20	25.61	25.01	24.42	23.83	23.23
		12	26.98	25.35	24.54	23.72	22.91	22.10	21.28	20.47	19.65
		14	25.24	23.14	22.09	21.05	20.00	18.95	17.90	16.85	15.81 <sup>7</sup>
	6	8	29.76	28.67	28.13	27.59	27.04	26.50	25.96	25.42	24.88
		9	29.09	27.74	27.07	26.40	25.72	25.05	24.37	23.70	23.03
		10	28.35	26.72	25.90	25.09	24.27	23.46	22.64	21.83	21.01
		12	26.67	24.43	23.32	22.20	21.08	19.96	18.84	17.72	16.60
		14	24.84	21.96	20.52	19.08	17.64	16.20 <sup>7</sup>	14.76 <sup>6</sup>	13.32 <sup>6</sup>	11.88 <sup>6</sup>
	8	8	29.61	28.23	27.54	26.85	26.16	25.47	24.78	24.09	23.40
		9	28.91	27.19	26.33	25.48	24.62	23.76	22.90	22.04	21.19
		10	28.13	26.05	25.01	23.98	22.94	21.90	20.86	19.82	18.79
		12	26.37	23.52	22.10	20.67	19.25	17.82	16.40	14.97 <sup>7</sup>	13.55 <sup>6</sup>
		14	24.45	20.78	18.95	17.12	15.28 <sup>7</sup>	13.45 <sup>6</sup>	11.62 <sup>6</sup>	9.78 <sup>5</sup>	7.95 <sup>5</sup>
	10	8	29.46	27.78	26.95	26.11	25.27	24.43	23.59	22.76	21.92
		9	28.73	26.64	25.60	24.56	23.52	22.47	21.43	20.39	19.35
		10	27.91	25.38	24.12	22.86	21.60	20.34	19.08	17.82	16.56
		12	26.06	22.60	20.87	19.14	17.42	15.69 <sup>7</sup>	13.96 <sup>7</sup>	12.23 <sup>6</sup>	10.50 <sup>6</sup>
		14	24.06	19.60	17.38	15.15 <sup>7</sup>	12.93 <sup>6</sup>	10.70 <sup>6</sup>	8.47 <sup>6</sup>	6.25 <sup>3</sup>	4.02 <sup>3</sup>
10	8	29.46	27.78	26.95	26.11	25.27	24.43	23.59	22.76	21.92	
	9	28.73	26.64	25.60	24.56	23.52	22.47	21.43	20.39	19.35	
	10	27.91	25.38	24.12	22.86	21.60	20.34	19.08	17.82	16.56	
	12	26.06	22.60	20.87	19.14	17.42	15.69 <sup>7</sup>	13.96 <sup>7</sup>	12.23 <sup>6</sup>	10.50 <sup>6</sup>	
	14	24.06	19.60	17.38	15.15 <sup>7</sup>	12.93 <sup>6</sup>	10.70 <sup>6</sup>	8.47 <sup>6</sup>	6.25 <sup>3</sup>	4.02 <sup>3</sup>	
10	8	29.46	27.78	26.95	26.11	25.27	24.43	23.59	22.76	21.92	
	9	28.73	26.64	25.60	24.56	23.52	22.47	21.43	20.39	19.35	
	10	27.91	25.38	24.12	22.86	21.60	20.34	19.08	17.82	16.56	
	12	26.06	22.60	20.87	19.14	17.42	15.69 <sup>7</sup>	13.96 <sup>7</sup>	12.23 <sup>6</sup>	10.50 <sup>6</sup>	
	14	24.06	19.60	17.38	15.15 <sup>7</sup>	12.93 <sup>6</sup>	10.70 <sup>6</sup>	8.47 <sup>6</sup>	6.25 <sup>3</sup>	4.02 <sup>3</sup>	
10	8	29.46	27.78	26.95	26.11	25.27	24.43	23.59	22.76	21.92	
	9	28.73	26.64	25.60	24.56	23.52	22.47	21.43	20.39	19.35	
	10	27.91	25.38	24.12	22.86	21.60	20.34	19.08	17.82	16.56	
	12	26.06	22.60	20.87	19.14	17.42	15.69 <sup>7</sup>	13.96 <sup>7</sup>	12.23 <sup>6</sup>	10.50 <sup>6</sup>	
	14	24.06	19.60	17.38	15.15 <sup>7</sup>	12.93 <sup>6</sup>	10.70 <sup>6</sup>	8.47 <sup>6</sup>	6.25 <sup>3</sup>	4.02 <sup>3</sup>	
10	8	29.46	27.78	26.95	26.11	25.27	24.43	23.59	22.76	21.92	
	9	28.73	26.64	25.60	24.56	23.52	22.47	21.43	20.39	19.35	
	10	27.91	25.38	24.12	22.86	21.60	20.34	19.08	17.82	16.56	
	12	26.06	22.60	20.87	19.14	17.42	15.69 <sup>7</sup>	13.96 <sup>7</sup>	12.23 <sup>6</sup>	10.50 <sup>6</sup>	
	14	24.06	19.60	17.38	15.15 <sup>7</sup>	12.93 <sup>6</sup>	10.70 <sup>6</sup>	8.47 <sup>6</sup>	6.25 <sup>3</sup>	4.02 <sup>3</sup>	
10	8	29.46	27.78	26.95	26.11	25.27	24.43	23.59	22.76	21.92	
	9	28.73	26.64	25.60	24.56	23.52	22.47	21.43	20.39	19.35	
	10	27.91	25.38	24.12	22.86	21.60	20.34	19.08	17.82	16.56	
	12	26.06	22.60	20.87	19.14	17.42	15.69 <sup>7</sup>	13.96 <sup>7</sup>	12.23 <sup>6</sup>	10.50 <sup>6</sup>	
	14	24.06	19.60	17.38	15.15 <sup>7</sup>	12.93 <sup>6</sup>	10.70 <sup>6</sup>	8.47 <sup>6</sup>	6.25 <sup>3</sup>	4.02 <sup>3</sup>	
10	8	29.46	27.78	26.95	26.11	25.27	24.43	23.59	22.76	21.92	
	9	28.73	26.64	25.60	24.56	23.52	22.47	21.43	20.39	19.35	
	10	27.91	25.38	24.12	22.86	21.60	20.34	19.08	17.82	16.56	
	12	26.06	22.60	20.87	19.14	17.42	15.69 <sup>7</sup>	13.96 <sup>7</sup>	12.23 <sup>6</sup>	10.50 <sup>6</sup>	
	14	24.06	19.60	17.38	15.15 <sup>7</sup>	12.93 <sup>6</sup>	10.70 <sup>6</sup>	8.47 <sup>6</sup>	6.25 <sup>3</sup>	4.02 <sup>3</sup>	
10	8	29.46	27.78	26.95	26.11	25.27	24.43	23.59	22.76	21.92	
	9	28.73	26.64	25.60	24.56	23.52	22.47	21.43	20.39	19.35	
	10	27.91	25.38	24.12	22.86	21.60	20.34	19.08	17.82	16.56	
	12	26.06	22.60	20.87	19.14	17.42	15.69 <sup>7</sup>	13.96 <sup>7</sup>	12.23 <sup>6</sup>	10.50 <sup>6</sup>	
	14	24.06	19.60	17.38	15.15 <sup>7</sup>	12.93 <sup>6</sup>	10.70 <sup>6</sup>	8.47 <sup>6</sup>	6.25 <sup>3</sup>	4.02 <sup>3</sup>	
10	8	29.46	27.78	26.95	26.11	25.27	24.43	23.59	22.76	21.92	
	9	28.73	26.64	25.60	24.56	23.52	22.47	21.43	20.39	19.35	
	10										

Refer to Important Table Notes on Page 17

JamStud® Allowable Axial Loads for Load Bearing Openings											
Section	Opening Width (ft)	Wall Height (ft)	Lateral Wind Pressure (psf)								
			5	15	20	25	30	35	40	45	50
800JAM250-43, 50ksi	4	8	6.92	6.34	6.04	5.75	5.46	5.16	4.87	4.58	4.28
		9	6.81	6.07	5.70	5.33	4.96	4.60	4.23	3.86	3.49
		10	6.68	5.78	5.32	4.87	4.42	3.96	3.51	3.06	2.60
		12	6.37	5.09	4.45	3.81	3.17	2.52	1.88	1.24 <sup>7</sup>	0.60 <sup>7</sup>
		14	5.99	4.29	3.43	2.58	1.73 <sup>7</sup>	0.88 <sup>6</sup>	0.03 <sup>6</sup>		
	6	8	6.81	6.01	5.60	5.20	4.80	4.39	3.99	3.59	3.18
		9	6.67	5.66	5.15	4.64	4.13	3.63	3.12	2.61	2.10
		10	6.51	5.27	4.64	4.02	3.40	2.77	2.15	1.53	0.91
		12	6.13	4.37	3.49	2.60	1.72	0.84 <sup>7</sup>			
		14	5.67	3.33	2.16 <sup>7</sup>	0.99 <sup>6</sup>					
	8	8	6.70	5.68	5.16	4.65	4.14	3.62	3.11	2.60	2.08
		9	6.53	5.24	4.60	3.95	3.30	2.66	2.01	1.36	0.72
		10	6.34	4.76	3.96	3.17	2.38	1.58	0.79		
		12	5.89	3.65	2.52	1.40 <sup>7</sup>	0.28 <sup>6</sup>				
		14	5.35	2.37	0.88 <sup>6</sup>						
	10	8	6.59	5.35	4.72	4.10	3.48	2.85	2.23	1.61	0.98
		9	6.40	4.83	4.04	3.26	2.47	1.69	0.90	0.12	
		10	6.17	4.25	3.28	2.32	1.36	0.40			
		12	5.65	2.92	1.56	0.20 <sup>6</sup>					
		14	5.03	1.41 <sup>7</sup>							
800JAM250-54, 50ksi	4	8	9.28	8.71	8.43	8.15	7.87	7.59	7.30	7.02	6.74
		9	9.16	8.45	8.09	7.74	7.38	7.02	6.67	6.31	5.96
		10	9.01	8.14	7.71	7.27	6.83	6.40	5.96	5.53	5.09
		12	8.66	7.43	6.81	6.20	5.58	4.97	4.35	3.73	3.12
		14	8.22	6.59	5.77	4.95	4.14	3.32 <sup>7</sup>	2.50 <sup>7</sup>	1.69 <sup>6</sup>	0.87 <sup>6</sup>
	6	8	9.17	8.40	8.01	7.62	7.23	6.85	6.46	6.07	5.68
		9	9.02	8.05	7.56	7.07	6.58	6.09	5.60	5.11	4.63
		10	8.85	7.65	7.05	6.45	5.85	5.26	4.66	4.06	3.46
		12	8.43	6.74	5.89	5.04	4.20	3.35	2.50 <sup>7</sup>	1.65 <sup>7</sup>	0.81 <sup>6</sup>
		14	7.91	5.67	4.54	3.42 <sup>7</sup>	2.30 <sup>6</sup>	1.17 <sup>6</sup>	0.05 <sup>6</sup>		
	8	8	9.07	8.08	7.59	7.09	6.60	6.10	5.61	5.12	4.62
		9	8.89	7.65	7.02	6.40	5.78	5.16	4.54	3.92	3.29
		10	8.69	7.16	6.40	5.64	4.87	4.11	3.35	2.59	1.82
		12	8.20	6.04	4.97	3.89	2.81	1.73 <sup>7</sup>	0.65 <sup>6</sup>		
		14	7.61	4.75	3.32 <sup>7</sup>	1.89 <sup>6</sup>	0.46 <sup>6</sup>				
	10	8	8.96	7.76	7.16	6.56	5.96	5.36	4.76	4.16	3.56
		9	8.76	7.25	6.49	5.74	4.98	4.23	3.47	2.72	1.96
		10	8.52	6.67	5.75	4.82	3.89	2.97	2.04	1.12 <sup>7</sup>	0.19 <sup>7</sup>
		12	7.97	5.35	4.04	2.73	1.42 <sup>7</sup>	0.11 <sup>6</sup>			
		14	7.30	3.83	2.09 <sup>6</sup>	0.36 <sup>6</sup>					
800JAM250-68, 50ksi	4	8	13.36	12.77	12.48	12.19	11.90	11.60	11.31	11.02	10.73
		9	13.21	12.48	12.11	11.74	11.37	11.00	10.63	10.27	9.90
		10	13.04	12.14	11.68	11.23	10.78	10.33	9.88	9.43	8.98
		12	12.61	11.34	10.70	10.06	9.42	8.78	8.14	7.50	6.87
		14	12.08	10.38	9.54	8.69	7.84	6.99	6.14	5.30 <sup>7</sup>	4.45 <sup>7</sup>
	6	8	13.25	12.44	12.04	11.64	11.24	10.84	10.43	10.03	9.63
		9	13.07	12.06	11.55	11.05	10.54	10.04	9.53	9.02	8.52
		10	12.87	11.63	11.01	10.39	9.77	9.15	8.52	7.90	7.28
		12	12.37	10.62	9.74	8.86	7.98	7.11	6.23	5.35	4.47 <sup>7</sup>
		14	11.76	9.43	8.26	7.10	5.93	4.77 <sup>7</sup>	3.60 <sup>6</sup>	2.43 <sup>6</sup>	1.27 <sup>6</sup>
	8	8	13.14	12.12	11.60	11.09	10.58	10.07	9.56	9.05	8.53
		9	12.94	11.65	11.00	10.36	9.71	9.07	8.43	7.78	7.14
		10	12.70	11.12	10.33	9.54	8.75	7.96	7.17	6.38	5.59
		12	12.13	9.90	8.78	7.66	6.55	5.43	4.31 <sup>7</sup>	3.19 <sup>7</sup>	2.08 <sup>6</sup>
		14	11.44	8.48	6.99	5.51 <sup>7</sup>	4.02 <sup>6</sup>	2.54 <sup>6</sup>	1.06 <sup>6</sup>		
	10	8	13.03	11.79	11.17	10.54	9.92	9.30	8.68	8.06	7.44
		9	12.80	11.23	10.45	9.67	8.89	8.10	7.32	6.54	5.76
		10	12.53	10.61	9.65	8.69	7.73	6.77	5.82	4.86	3.90
		12	11.90	9.18	7.82	6.47	5.11	3.75 <sup>7</sup>	2.39 <sup>6</sup>	1.04 <sup>6</sup>	
		14	11.13	7.52	5.72 <sup>7</sup>	3.92 <sup>6</sup>	2.12 <sup>6</sup>	0.31 <sup>6</sup>			
16	10.25	5.69 <sup>7</sup>	3.40 <sup>6</sup>	1.12 <sup>6</sup>							

Refer to Important Table Notes on Page 17

JamStud® Allowable Axial Loads for Load Bearing Openings											
Section	Opening Width (ft)	Wall Height (ft)	Lateral Wind Pressure (psf)								
			5	15	20	25	30	35	40	45	50
800JAM250-97, 50ksi	4	8	22.02	21.47	21.19	20.92	20.65	20.37	20.10	19.82	19.55
		9	21.79	21.10	20.76	20.41	20.07	19.72	19.38	19.03	18.69
		10	21.52	20.67	20.25	19.83	19.41	18.99	18.57	18.14	17.72
		12	20.81	19.63	19.03	18.44	17.85	17.26	16.67	16.07	15.48
		14	19.88	18.32	17.55	16.77	15.99	15.21	14.44	13.66	12.88
	6	8	21.91	21.16	20.78	20.41	20.03	19.65	19.28	18.90	18.52
		9	21.66	20.71	20.24	19.77	19.29	18.82	18.35	17.87	17.40
		10	21.36	20.20	19.62	19.04	18.46	17.88	17.30	16.72	16.14
		12	20.59	18.96	18.15	17.33	16.52	15.70	14.89	14.08	13.26
		14	19.59	17.45	16.38	15.31	14.24	13.17	12.10	11.03 <sup>7</sup>	9.96 <sup>7</sup>
	8	8	21.81	20.85	20.37	19.89	19.41	18.93	18.45	17.97	17.49
		9	21.53	20.33	19.72	19.12	18.52	17.92	17.31	16.71	16.11
		10	21.20	19.73	18.99	18.25	17.51	16.78	16.04	15.30	14.56
		12	20.37	18.29	17.26	16.22	15.19	14.15	13.11	12.08	11.04
		14	19.30	16.57	15.21	13.85	12.49	11.13 <sup>7</sup>	9.77 <sup>7</sup>	8.41 <sup>6</sup>	7.05 <sup>5</sup>
	10	8	21.71	20.54	19.96	19.38	18.80	18.21	17.63	17.05	16.47
		9	21.40	19.94	19.21	18.47	17.74	17.01	16.28	15.55	14.82
		10	21.04	19.25	18.36	17.46	16.56	15.67	14.77	13.88	12.98
		12	20.14	17.63	16.37	15.11	13.85	12.60	11.34	10.08 <sup>7</sup>	8.82 <sup>7</sup>
		14	19.01	15.70	14.05	12.39	10.74 <sup>7</sup>	9.09 <sup>6</sup>	7.44 <sup>6</sup>	5.78 <sup>6</sup>	4.13 <sup>6</sup>
800JAM250-118, 50ksi	4	8	28.37	27.83	27.56	27.30	27.03	26.76	26.49	26.22	25.96
		9	28.10	27.42	27.09	26.75	26.41	26.08	25.74	25.40	25.07
		10	27.77	26.94	26.53	26.12	25.71	25.30	24.88	24.47	24.06
		12	26.91	25.75	25.17	24.59	24.02	23.44	22.86	22.28	21.70
		14	25.76	24.24	23.48	22.72	21.96	21.20	20.44	19.68	18.92
	6	8	28.27	27.53	27.16	26.79	26.43	26.06	25.69	25.32	24.95
		9	27.97	27.04	26.58	26.12	25.66	25.19	24.73	24.27	23.80
		10	27.61	26.48	25.91	25.35	24.78	24.21	23.65	23.08	22.52
		12	26.69	25.10	24.30	23.51	22.71	21.92	21.12	20.33	19.53
		14	25.48	23.39	22.34	21.30	20.25	19.21	18.16	17.12	16.08
	8	8	28.07	26.93	26.36	25.79	25.22	24.65	24.08	23.51	22.94
		9	27.72	26.29	25.57	24.86	24.14	23.43	22.71	22.00	21.28
		10	27.30	25.55	24.68	23.80	22.93	22.05	21.18	20.30	19.43
		12	26.26	23.80	22.57	21.34	20.11	18.88	17.65	16.42	15.19
		14	24.91	21.68	20.06	18.45	16.83	15.22 <sup>7</sup>	13.61 <sup>7</sup>	11.99 <sup>6</sup>	10.38 <sup>6</sup>
	10	8	28.30	27.27	26.70	26.13	25.56	24.99	24.42	23.85	23.28
		9	28.07	26.93	26.36	25.79	25.22	24.65	24.08	23.51	22.94
		10	27.72	26.29	25.57	24.86	24.14	23.43	22.71	22.00	21.28
		12	26.26	23.80	22.57	21.34	20.11	18.88	17.65	16.42	15.19
		14	24.91	21.68	20.06	18.45	16.83	15.22 <sup>7</sup>	13.61 <sup>7</sup>	11.99 <sup>6</sup>	10.38 <sup>6</sup>
800JAM350-68, 50ksi	4	8	13.80	13.23	12.95	12.67	12.38	12.10	11.82	11.54	11.25
		9	13.63	12.92	12.56	12.21	11.85	11.50	11.14	10.79	10.43
		10	13.43	12.56	12.13	11.69	11.26	10.82	10.39	9.96	9.52
		12	12.96	11.74	11.12	10.51	9.90	9.29	8.67	8.06	7.45
		14	12.39	10.77	9.95	9.14	8.33	7.52	6.71	5.90	5.09
	6	8	13.69	12.91	12.52	12.14	11.75	11.36	10.97	10.58	10.20
		9	13.49	12.52	12.03	11.54	11.05	10.57	10.08	9.59	9.10
		10	13.27	12.07	11.48	10.88	10.28	9.68	9.09	8.49	7.89
		12	12.73	11.05	10.20	9.36	8.52	7.68	6.84	5.99	5.15
		14	12.08	9.85	8.74	7.62	6.51	5.40	4.28 <sup>7</sup>	3.17 <sup>6</sup>	2.05 <sup>6</sup>
	8	8	13.58	12.60	12.10	11.61	11.11	10.62	10.13	9.63	9.14
		9	13.36	12.12	11.50	10.88	10.26	9.63	9.01	8.39	7.77
		10	13.11	11.59	10.82	10.06	9.30	8.54	7.78	7.02	6.26
		12	12.50	10.36	9.29	8.21	7.14	6.07	5.00	3.93	2.86 <sup>7</sup>
		14	11.78	8.94	7.52	6.11	4.69 <sup>7</sup>	3.27 <sup>6</sup>	1.85 <sup>6</sup>	0.43 <sup>6</sup>	
	10	8	13.48	12.28	11.68	11.08	10.48	9.88	9.28	8.68	8.08
		9	13.23	11.72	10.97	10.21	9.46	8.70	7.95	7.20	6.44
		10	12.94	11.10	10.17	9.25	8.33	7.40	6.48	5.56	4.63
		12	12.27	9.67	8.37	7.07	5.76	4.46	3.16 <sup>7</sup>	1.86 <sup>7</sup>	0.56 <sup>6</sup>
		14	11.47	8.03	6.31	4.59 <sup>7</sup>	2.86 <sup>6</sup>	1.14 <sup>6</sup>			
10	8	13.48	12.28	11.68	11.08	10.48	9.88	9.28	8.68	8.08	
	9	13.23	11.72	10.97	10.21	9.46	8.70	7.95	7.20	6.44	
	10	12.94	11.10	10.17	9.25	8.33	7.40	6.48	5.56	4.63	
	12	12.27	9.67	8.37	7.07	5.76	4.46	3.16 <sup>7</sup>	1.86 <sup>7</sup>	0.56 <sup>6</sup>	
	14	11.47	8.03	6.31	4.59 <sup>7</sup>	2.86 <sup>6</sup>	1.14 <sup>6</sup>				

Refer to Important Table Notes on Page 17

JamStud® Allowable Axial Loads for Load Bearing Openings											
Section	Opening Width (ft)	Wall Height (ft)	Lateral Wind Pressure (psf)								
			5	15	20	25	30	35	40	45	50
800JAM350-97, 50ksi	4	8	24.38	23.77	23.47	23.17	22.87	22.57	22.27	21.97	21.67
		9	24.15	23.39	23.01	22.63	22.25	21.88	21.50	21.12	20.74
		10	23.88	22.95	22.49	22.02	21.56	21.10	20.63	20.17	19.70
		12	23.23	21.92	21.26	20.60	19.95	19.29	18.64	17.98	17.33
		14	22.42	20.68	19.81	18.94	18.07	17.20	16.33	15.46	14.59
		16	21.47	19.27	18.17	17.07	15.96	14.86	13.76	12.66	11.56 <sup>7</sup>
	6	8	24.26	23.44	23.02	22.61	22.19	21.78	21.37	20.95	20.54
		9	24.01	22.96	22.44	21.92	21.40	20.88	20.36	19.84	19.32
		10	23.71	22.43	21.79	21.15	20.52	19.88	19.24	18.60	17.96
		12	22.98	21.18	20.28	19.37	18.47	17.57	16.67	15.77	14.87
		14	22.10	19.70	18.51	17.31	16.11	14.92	13.72	12.52	11.32
		16	21.06	18.03	16.51	15.00	13.48	11.97	10.45 <sup>7</sup>	8.94 <sup>6</sup>	7.42 <sup>6</sup>
	8	8	24.15	23.10	22.57	22.04	21.52	20.99	20.46	19.94	19.41
		9	23.86	22.54	21.88	21.21	20.55	19.89	19.22	18.56	17.90
		10	23.53	21.91	21.10	20.28	19.47	18.66	17.85	17.03	16.22
		12	22.73	20.44	19.29	18.15	17.00	15.85	14.70	13.56	12.41
		14	21.77	18.72	17.20	15.68	14.15	12.63	11.11	9.58 <sup>7</sup>	8.06 <sup>6</sup>
		16	20.65	16.79	14.86	12.93	11.01 <sup>7</sup>	9.08 <sup>6</sup>	7.156	5.22 <sup>6</sup>	3.29 <sup>6</sup>
	10	8	24.04	22.76	22.12	21.48	20.84	20.20	19.56	18.92	18.28
		9	23.72	22.11	21.31	20.50	19.70	18.89	18.09	17.28	16.48
		10	23.36	21.39	20.40	19.41	18.43	17.44	16.45	15.47	14.48
		12	22.49	19.70	18.31	16.92	15.52	14.13	12.74	11.34	9.95
		14	21.44	17.74	15.89	14.04	12.19	10.35 <sup>7</sup>	8.50 <sup>7</sup>	6.65 <sup>6</sup>	4.80 <sup>6</sup>
		16	20.23	15.55	13.21	10.87 <sup>7</sup>	8.53 <sup>6</sup>	6.18 <sup>6</sup>	3.84 <sup>6</sup>	1.50 <sup>6</sup>	
800JAM350-118, 50ksi	4	8	33.11	32.49	32.18	31.87	31.55	31.24	30.93	30.62	30.31
		9	32.75	31.97	31.58	31.19	30.80	30.40	30.01	29.62	29.23
		10	32.32	31.37	30.89	30.41	29.94	29.46	28.98	28.50	28.03
		12	31.28	29.94	29.27	28.60	27.93	27.26	26.59	25.92	25.26
		14	30.02	28.25	27.37	26.49	25.61	24.73	23.85	22.96	22.08
		16	28.58	26.37	25.26	24.16	23.05	21.94	20.84	19.73	18.63
	6	8	32.99	32.14	31.71	31.28	30.85	30.43	30.00	29.57	29.14
		9	32.60	31.53	30.99	30.45	29.92	29.38	28.84	28.30	27.77
		10	32.14	30.83	30.17	29.52	28.86	28.21	27.55	26.89	26.24
		12	31.03	29.19	28.27	27.35	26.43	25.51	24.59	23.66	22.74
		14	29.69	27.26	26.05	24.84	23.63	22.41	21.20	19.99	18.78
		16	28.17	25.12	23.60	22.08	20.56	19.04	17.52	16.00 <sup>7</sup>	14.48 <sup>7</sup>
	8	8	32.88	31.79	31.24	30.70	30.15	29.61	29.06	28.52	27.97
		9	32.46	31.09	30.40	29.72	29.04	28.35	27.67	26.99	26.30
		10	31.96	30.29	29.46	28.62	27.79	26.95	26.12	25.28	24.45
		12	30.78	28.44	27.26	26.09	24.92	23.75	22.58	21.40	20.23
		14	29.36	26.27	24.73	23.19	21.64	20.10	18.56	17.01	15.47
		16	27.75	23.88	21.94	20.01	18.07	16.14 <sup>7</sup>	14.20 <sup>7</sup>	12.26 <sup>6</sup>	10.33 <sup>6</sup>
	10	8	32.76	31.44	30.78	30.11	29.45	28.79	28.13	27.47	26.81
		9	32.31	30.65	29.82	28.99	28.16	27.33	26.50	25.67	24.84
		10	31.79	29.76	28.74	27.73	26.71	25.70	24.68	23.67	22.66
		12	30.53	27.68	26.26	24.84	23.41	21.99	20.57	19.14	17.72
		14	29.03	25.28	23.41	21.53	19.66	17.79	15.91	14.04 <sup>7</sup>	12.17 <sup>6</sup>
		16	27.34	22.64	20.29	17.93	15.58 <sup>7</sup>	13.23 <sup>6</sup>	10.88 <sup>6</sup>	8.53 <sup>6</sup>	6.18 <sup>6</sup>

## The Simple Choice to Increase Your Production

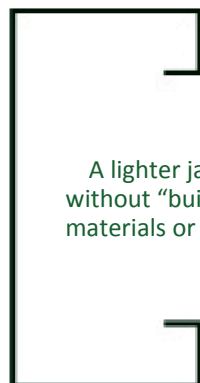
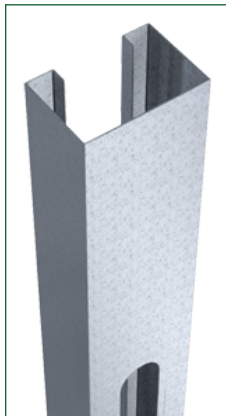

A lighter jamb without "built-up" materials or labor.

**OR**

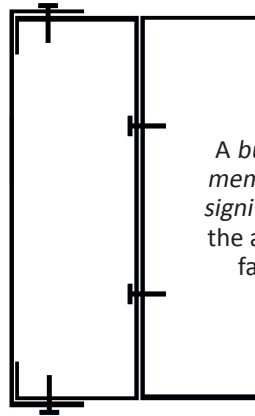

A built-up, multiple member jamb with a significant increase in the amount of screw fasteners used.

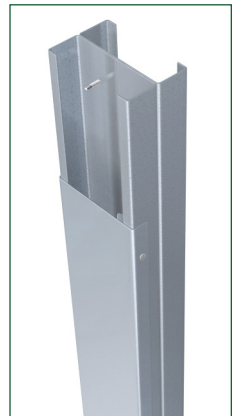

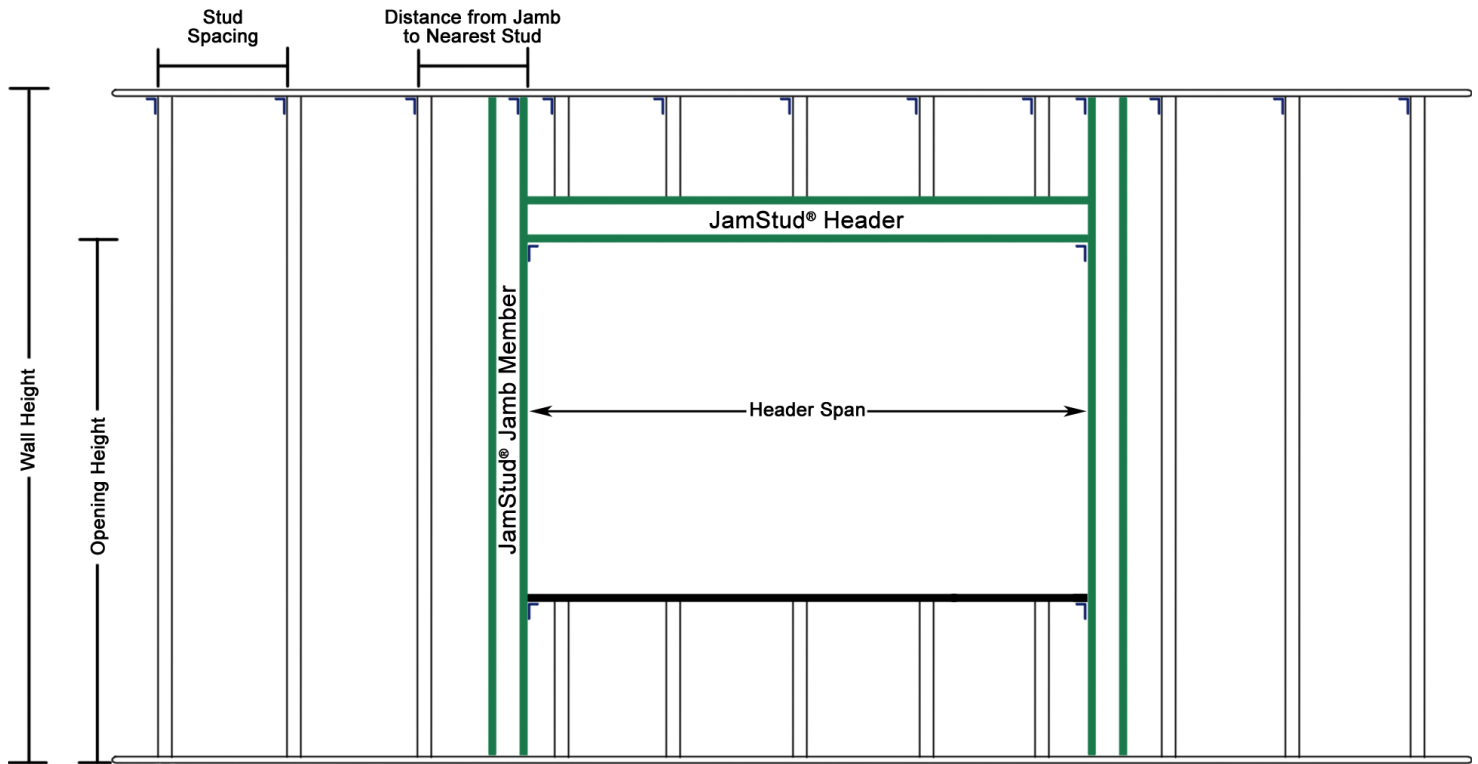

## 1. Basis for Tables

The JamStud Non Load Bearing Opening Allowable Header Spans table in this catalog cover the following basic load combination for the Allowable Stress Design (ASD) Method (IBC 2018 and ASCE 7-16). Listed wind pressures represent calculated design wind pressure ( $0.6W$  based on IBC 2018).

- $D + 0.6W_{c\&c}$  (ASCE 7-16)

$W_{c\&c}$  is the component & cladding wind load. A sheathing dead load (D) of 12 psf acting vertically on the header is assumed in the tables.

For deflection determination, IBC 2018 Sec. 1604.3 and AISI S240-15 North American Standard for Cold-Formed Steel Structural Framing Sec. B1.1.2. allow for a reduction factor of 0.7 on the component & cladding wind load ( $0.7W_{c\&c}$ ).

The “JamStud – Allowable Header Spans” tables are based on the following assumptions:

- 4-Way distribution of lateral wind pressure acting on the opening
- Opening height extends from floor level to the bottom surface of the header
- Header supports wind pressure from opening, wind pressure from half distance to floor above, and vertical dead load from sheathing above

The input for the tables are: JamStud section, the wall height (ft.), the opening height (ft.), the design wind pressure ( $WC\&C$ , psf), and the specified deflection limit. The output from the tables includes: the allowable JamStud span or opening width (ft.-in.) and controlling design factor, strength or deflection (“f” denotes strength, “d” denotes deflection).

## 2. Design Example

### Given:

Wind Pressure ( $0.6W_{c\&c}$ )(ASCE 7-16)	= 30 psf
Wall Width	= 6.0 in.
Header Span	= 9.0 ft.
Opening Height	= 10.0 ft.
Specified Deflection Limit	= L/360

### 3. Design Header

Go to JamStud® Non Load Bearing Opening Allowable Header Spans table with 6.0 in. stud member, 30 psf wind load, L/360 deflection limit, 13.0 ft. wall height, and 10.0 ft. opening height. Possible JamStud selections from the table for a 9.0 ft. header span are a 600JAM250-54 (allowable span = 9' 0").

#### Conclusion:

Use 600JAM250-54 (50ksi) (with design thickness. = 0.0556" and Fy = 50 ksi).

#### Important Note:

When ordering JamStud header solutions, indicate that the punchouts are not required. Designate JamStud without punchouts on plans and specify header use when ordering.

### 4. Design Comparison of Header Components

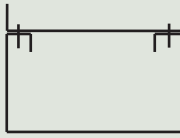
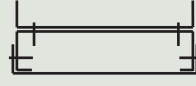
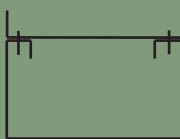
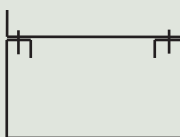
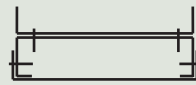
Design Case	Typical Wall Stud	JamStud® Solution		Typical Built-Up Header	
		Section*	Shape	Section*	Shape
$W_{c\&c} = 30$ psf Wall Width = 6.0" Wall Height = 13.0' Header Span = 9.0' Opening Height = 10.0' Deflection Limit = L/360	600S162-43	Single 600JAM250-54		(1) Stud 600S162-54 + (1) Track 600T125-54, attached at 24" o.c. max. horizontally	
$W_{c\&c} = 20$ psf Wall Width = 3.625" Wall Height = 11.0' Header Span = 10.0' Opening Height = 8.0' Deflection Limit = L/600	362S162-43	362JAM350-68 + 362T200-54		(2) Studs 362S162-68 + (2) Tracks 362T125-68, attached at 24" o.c. max. horizontally	
$W_{c\&c} = 35$ psf Wall Width = 8.0" Wall Height = 15.0' Header Span = 10.0' Opening Height = 10.0' Deflection Limit = L/360	800S162-54	Single 800JAM350-68		(1) Stud 800S162-54 + (1) Track 800T125-54, attached at 24" o.c. max. horizontally	

\* The runner track for the attachment of cripple studs was not considered as part of the design cross-section.

Important Notes

1. A sheathing dead load of 12 psf acting vertically on the header is considered in the calculations.
2. Lateral loads have not been modified for strength checks: full loads are applied.
3. Listed wind pressures represent calculated design wind pressure (0.6W based on 2018 IBC).
4. 15 psf and higher wind pressures have been multiplied by 0.7 for deflection determination, in accordance with footnote "f" of IBC table 1604.3. The 5 psf pressure has not been reduced for deflection checks.
5. "f" denotes limiting header span is controlled by strength, while "d" denotes limiting header span is controlled by deflection.
6. Header is assumed to be connected to jamb member through a stiffening clip to eliminate a web crippling condition.
7. Limiting header spans are based on continuous support of each flange over the full length of the member.
8. Strength determination includes checks for bending and shear capacity values of the header.
9. Designate JamStud without punchouts on drawings when utilized for header applications.
10. Moment of inertia for deflection is optimized based on the maximum moment at service loads for the listed spans; therefore; span values may be greater than spans based on an effective moment of inertia listed in section property tables.

Section	Wall Ht. (ft)	Opening Height (ft)	Wind Pressure (PSF) And Deflection Limits																										
			5 psf			15 psf			20 psf			25 psf			30 psf			35 psf			40 psf			45 psf			50 psf		
			L/120	L/240	L/360	L/240	L/360	L/600	L/240	L/360	L/600	L/240	L/360	L/600	L/240	L/360	L/600	L/240	L/360	L/600	L/240	L/360	L/600	L/240	L/360	L/600	L/240	L/360	L/600
362JAM250-43, 50ksi	9	6	10'9"	9'2"	8'0"	8'9"	8'9"	7'7"	8'2"	8'2"	7'7"	7'8"	7'8"	7'4"	7'3"	7'3"	7'0"	6'11"	6'11"	6'8"	6'7"	6'7"	6'5"	6'5"	6'5"	6'2"	6'2"	6'2"	6'0"
		8	15'1"	13'3"	11'7"	10'11"	10'6"	9'1"	9'11"	9'8"	8'5"	9'2"	9'1"	7'11"	8'8"	8'8"	7'7"	8'3"	8'3"	7'3"	7'10"	7'10"	7'0"	7'7"	7'7"	6'9"	7'4"	7'4"	6'7"
		10	10'7"	9'2"	8'0"	8'7"	8'7"	7'7"	8'0"	8'0"	7'7"	7'7"	7'7"	7'4"	7'2"	7'2"	6'11"	6'10"	6'10"	6'8"	6'7"	6'7"	6'5"	6'4"	6'4"	6'2"	6'2"	6'2"	6'0"
	11	8	10'7"	9'2"	8'0"	8'7"	8'7"	7'7"	8'0"	8'0"	7'7"	7'7"	7'7"	7'4"	7'2"	7'2"	6'11"	6'10"	6'10"	6'8"	6'7"	6'7"	6'5"	6'4"	6'4"	6'2"	6'2"	6'2"	6'0"
		10	14'7"	13'3"	11'7"	10'8"	10'4"	9'1"	9'9"	9'7"	8'5"	9'1"	9'1"	7'11"	8'7"	8'7"	7'7"	8'3"	8'3"	7'3"	7'10"	7'10"	7'0"	7'7"	7'7"	6'9"	7'4"	7'4"	6'7"
		12	8'7"	7'9"	6'9"	7'4"	7'4"	6'5"	6'10"	6'10"	6'5"	6'6"	6'6"	6'5"	6'3"	6'3"	6'3"	5'11"	5'11"	5'11"	5'9"	5'9"	5'9"	5'6"	5'6"	5'6"	5'4"	5'4"	5'4"
	13	8	10'6"	9'2"	8'0"	8'7"	8'7"	7'7"	8'0"	8'0"	7'7"	7'7"	7'7"	7'4"	7'2"	7'2"	6'10"	6'10"	6'10"	6'8"	6'7"	6'7"	6'5"	6'4"	6'4"	6'2"	6'2"	6'2"	6'0"
		10	14'3"	13'3"	11'7"	10'7"	10'4"	9'1"	9'9"	9'7"	8'5"	9'1"	9'1"	7'11"	8'7"	8'7"	7'7"	8'3"	8'3"	7'3"	7'10"	7'10"	7'0"	7'7"	7'7"	6'9"	7'4"	7'4"	6'7"
		12	8'7"	7'9"	6'9"	7'4"	7'4"	6'5"	6'10"	6'10"	6'5"	6'6"	6'6"	6'5"	6'3"	6'3"	6'3"	5'11"	5'11"	5'11"	5'9"	5'9"	5'9"	5'6"	5'6"	5'6"	5'4"	5'4"	5'4"
	15	8	10'6"	9'2"	8'0"	8'7"	8'7"	7'7"	8'0"	8'0"	7'7"	7'7"	7'7"	7'4"	7'2"	7'2"	6'10"	6'10"	6'10"	6'8"	6'7"	6'7"	6'5"	6'4"	6'4"	6'2"	6'2"	6'2"	6'0"
		10	8'7"	7'9"	6'9"	7'4"	7'4"	6'5"	6'10"	6'10"	6'5"	6'6"	6'6"	6'5"	6'3"	6'3"	6'3"	5'11"	5'11"	5'11"	5'9"	5'9"	5'9"	5'6"	5'6"	5'6"	5'4"	5'4"	5'4"
		12	10'6"	9'2"	8'0"	8'7"	8'7"	7'7"	8'0"	8'0"	7'7"	7'7"	7'7"	7'4"	7'2"	7'2"	6'10"	6'10"	6'10"	6'8"	6'7"	6'7"	6'5"	6'4"	6'4"	6'2"	6'2"	6'2"	6'0"
362JAM250-54, 50ksi	9	6	12'1"	9'10"	8'7"	9'11"	9'8"	8'2"	9'2"	9'2"	8'2"	8'7"	8'7"	7'10"	8'2"	8'2"	7'5"	7'9"	7'9"	7'1"	7'5"	7'5"	6'10"	7'2"	7'2"	6'7"	6'11"	6'11"	6'5"
		8	16'9"	14'3"	12'5"	12'3"	11'2"	9'8"	11'1"	10'3"	8'11"	10'3"	9'8"	8'5"	9'8"	9'2"	8'0"	9'2"	8'9"	7'8"	8'9"	8'6"	7'5"	8'5"	8'2"	7'2"	8'1"	8'0"	7'0"
		10	11'11"	9'10"	8'7"	9'7"	9'7"	8'2"	8'11"	8'11"	8'2"	8'5"	8'5"	7'9"	8'0"	8'0"	7'5"	7'8"	7'8"	7'1"	7'4"	7'4"	6'10"	7'1"	7'1"	6'7"	6'11"	6'11"	6'5"
	11	8	16'5"	14'3"	12'5"	11'10"	10'11"	9'7"	10'10"	10'2"	8'10"	10'1"	9'7"	8'4"	9'6"	9'2"	8'0"	9'1"	8'9"	7'8"	8'8"	8'6"	7'5"	8'5"	8'2"	7'2"	8'1"	8'0"	7'0"
		10	11'9"	9'10"	8'7"	9'7"	9'7"	8'2"	8'11"	8'11"	8'2"	8'5"	8'5"	7'9"	8'0"	8'0"	7'5"	7'8"	7'8"	7'1"	7'4"	7'4"	6'10"	7'1"	7'1"	6'7"	6'11"	6'11"	6'5"
		12	16'0"	14'3"	12'5"	11'9"	10'11"	9'7"	10'9"	10'2"	8'10"	10'1"	9'7"	8'4"	9'6"	9'1"	8'0"	9'1"	8'9"	7'8"	8'8"	8'6"	7'5"	8'5"	8'2"	7'2"	8'1"	8'0"	7'0"
	13	8	8'4"	7'5"	6'5"	7'3"	7'3"	6'2"	6'10"	6'10"	6'2"	6'6"	6'6"	6'2"	6'3"	6'3"	6'2"	6'0"	6'0"	6'0"	5'9"	5'9"	5'9"	5'7"	5'7"	5'7"	5'5"	5'5"	5'5"
		10	9'8"	8'4"	7'3"	8'2"	8'2"	6'11"	7'8"	7'8"	6'11"	7'4"	7'4"	6'11"	7'0"	7'0"	6'11"	6'8"	6'8"	6'7"	6'5"	6'5"	6'4"	6'3"	6'3"	6'2"	6'0"	6'0"	5'11"
		12	11'9"	9'10"	8'7"	9'7"	9'7"	8'2"	8'11"	8'11"	8'2"	8'5"	8'5"	7'9"	8'0"	8'0"	7'5"	7'8"	7'8"	7'1"	7'4"	7'4"	6'10"	7'1"	7'1"	6'7"	6'11"	6'11"	6'5"
	15	8	13'4"	9'10"	8'7"	11'2"	10'5"	8'9"	10'4"	10'4"	8'9"	9'8"	9'8"	8'5"	9'2"	9'2"	7'11"	8'9"	8'9"	7'7"	8'4"	8'4"	7'3"	8'0"	8'0"	7'0"	7'9"	7'9"	6'10"
		10	19'0"	15'4"	13'4"	13'6"	11'11"	10'3"	12'4"	10'11"	9'5"	11'6"	10'3"	8'11"	10'9"	9'9"	8'5"	10'2"	9'4"	8'1"	9'8"	9'0"	7'10"	9'4"	8'8"	7'7"	8'11"	8'11"	7'5"
		12	13'4"	10'7"	9'3"	10'9"	10'5"	8'9"	10'0"	10'0"	8'9"	9'5"	9'5"	8'3"	8'11"	8'11"	7'10"	8'6"	8'6"	7'6"	8'2"	8'2"	7'3"	8'0"	8'0"	7'0"	7'8"	7'8"	6'10"
362JAM250-68, 50ksi	9	6	13'4"	10'7"	9'3"	11'2"	10'5"	8'9"	10'4"	10'4"	8'9"	9'8"	9'8"	8'5"	9'2"	9'2"	7'11"	8'9"	8'9"	7'7"	8'4"	8'4"	7'3"	8'0"	8'0"	7'0"	7'9"	7'9"	6'10"
		8	19'0"	15'4"	13'4"	13'6"	11'11"	10'3"	12'4"	10'11"	9'5"	11'6"	10'3"	8'11"	10'9"	9'9"	8'5"	10'2"	9'4"	8'1"	9'8"	9'0"	7'10"	9'4"	8'8"	7'7"	8'11"	8'11"	7'5"
		10	18'5"	15'4"	13'4"	13'0"	11'7"	10'1"	12'0"	10'9"	9'5"	11'2"	10'1"	8'10"	10'6"	9'8"	8'5"	10'0"	9'3"	8'1"	9'7"	8'11"	7'10"	9'3"	8'8"	7'7"	8'11"	8'11"	7'5"
	11	8	10'10"	8'11"	7'10"	9'2"	8'9"	7'5"	8'7"	8'7"	7'5"	8'2"	8'2"	7'5"	7'9"	7'9"	7'4"	7'5"	7'5"	7'0"	7'2"	7'2"	6'9"	6'11"	6'11"	6'6"	6'9"	6'9"	6'4"
		10	13'2"	10'7"	9'3"	10'7"	10'5"	8'9"	9'11"	9'11"	8'9"	9'4"	9'4"	8'3"	8'11"	8'11"	7'10"	8'6"	8'6"	7'6"	8'2"	8'2"	7'3"	7'11"	7'11"	7'0"	7'8"	7'8"	6'9"
		12	17'10"	15'4"	13'4"	12'10"	11'6"	10'1"	11'10"	10'9"	9'5"	11'1"	10'1"	8'10"	10'6"	9'8"	8'5"	10'0"	9'3"	8'1"	9'7"	8'11"	7'10"	9'3"	8'8"	7'7"	8'11"	8'11"	7'5"
	13	8	9'4"	8'0"	7'0"	8'1"	7'10"	6'7"	7'7"	7'7"	6'7"	7'3"	7'3"	6'7"	6'11"	6'11"	6'7"	6'8"	6'8"	6'7"	6'5"	6'5"	6'5"	6'3"	6'3"	6'2"	6'1"	6'1"	6'0"
		10	10'9"	8'11"	7'10"	9'1"	8'9"	7'5"	8'7"	8'7"	7'5"	8'2"	8'2"	7'5"	7'9"	7'9"	7'4"	7'5"	7'5"	7'0"	7'2"	7'2"	6'9"	6'11"	6'11"	6'6"	6'9"	6'9"	6'4"
		12	13'1"	10'7"	9'3"	10'7"	10'5"	8'9"	9'11"	9'11"	8'9"	9'4"	9'4"	8'3"	8'11"	8'11"	7'10"	8'6"	8'6"	7'6"	8'2"	8'2"	7'3"	7'11"	7'11"	7'0"	7'8"	7'8"	6'9"
	15	8	14'11"	11'10"	10'4"	13'4"	11'8"	9'10"	12'7"	11'8"	9'10"	11'11"	10'11"	9'3"	11'4"	10'3"	8'9"	10'10"	9'9"	8'4"	10'5"	9'5"	8'0"	10'0"	9'1"	7'9"	9'8"	8'9"	7'6"
		10	21'6"	17'1"	14'11"	14'11"	13'2"	11'3"	13'8"	12'1"	10'4"	12'9"	11'3"	9'9"	12'1"	10'8"	9'3"	11'6"	10'3"	8'10"	11'1"	9'10"	8'6"	10'8"	9'6"	8'3"	10'4"	9'3"	8'0"
		12	14'11"	11'10"	10'4"	13'2"	11'8"	9'10"	12'3"	11'3"	9'8"	11'6"	10'6"	9'0"	10'11"	9'11"	8'7"	10'5"	9'6"	8'2"	10'0"	9'2"	7'11"	9'7"	8'10"	7'8"	9'4"	8'7"	7'5"
362JAM250-97, 50ksi	9	6	14'11"	11'10"	10'4"	13'4"	11'8"	9'10"	12'7"	11'8"	9'10"	11'11"	10'11"	9'3"	11'4"	10'3"	8'9"	10'10"	9'9"	8'4"	10'5"	9'5"	8'0"	10'0"	9'1"	7'9"	9'8"	8'9"	7'6"
		8	21'6"	17'1"	14'11"	14'11"	13'2"	11'3"	13'8"	12'1"	10'4"	12'9"	11'3"	9'9"	12'1"	10'8"	9'3"	11'6"	10'3"	8'10"	11'1"	9'10"	8'6"	10'8"	9'6"	8'3"	10'4"	9'3"	8'0"
		10	14'11"	11'10"	10'4"	13'2"	11'8"	9'10"	12'3"	11'3"	9'8"	11'6"	10'6"	9'0"	10'11"	9'11"	8'7"	10'5"	9'6"	8'2"	10'0"	9'2"	7'11"	9'7"	8'10"	7'8"	9'4"	8'7"	7'5"
	11	8	21'6"	17'1"	14'11"	14'11"	13'2"	11'3"	13'8"	12'1"	10'4"	12'9"	11'3"	9'9"	12'1"	10'8"	9'3"	11'6"	10'3"	8'10"	11'1"	9'10"	8'6"	10'8"	9'6"	8'3"	10'2"	9'2"	8'0"
		10	12'7"	10'0"	8'8"	11'1"	9'10"	8'3"	10'5"	9'10"	8'3"	9'11"	9'10"	8'3"	9'5"	9'4"	8'1"	9'1"	8'11"	7'9"	8'9"	8'7"	7'5"	8'5"	8'4"	7'2"	8'2"	8'1"	6'11"
		12	14'11"	11'10"	10'4"	12'10"	11'8"	9'10"	12'0"	11'0"	9'7"	11'3"	10'4"	9'0"	10'9"	9'10"	8'7"	10'3"	9'5"	8'2"	9'10"	9'10"	7'11"	9'6"	8'10"	7'8"	9'3"	8'7"	7'5"
	13	8	21'5"	17'1"	14'11"	14'0"	12'7"	11'0"	12'0"	11'8"	10'2"	12'3"	11'0"	9'8"	11'8"	10'6"	9'2"	11'2"	10'1"	8'10"	10'10"	9'9"	8'11"	10'6"	9'5"	8'3"	10'2"	9'2"	8'0"
		10	11'2"	8'11"	7'9"	9'9"	8'9"	7'4"	9'3"	8'9"	7'4"	8'10"	8'9"	7'4"	8'5"	8'5"	7'4"	8'2"	8'2"	7'4"	7'10"	7'10"	7'0"	7'7"	7'7"	6'9"	7'5"	7'5"	6'7"
		12	12'7"	10'0"	8'8"	11'0"	9'10"	8'3"	10'4"	9'10"	8'3"	9'10"	9'10"	8'3"	9'5"	9'4"	8'1"	9'0"	8'11"	7'8"	8'9"	8'7"	7'5"	8'5"	8'4"	7'2"	8'2"	8'1"	6'11"
	15	8	14'11"	11'10"	10'4"	12'9"	11'8"	9'10"	11'11"	11'0"	9'7"	11'3"	10'4"	9'0"	10'8"	9'10"	8'7"	10'3"	9'5"	8'2"	9'10"	9'10"	7'11"	9'6"	8'10"	7'8"	9'3"	8'7"	7'5"
		10																											

# Exterior Wall Framing & Accessories JamStud® Non Load Bearing Opening Allowable Header Spans

Refer to Important Table Notes on Page 33

Section	Wall Ht. (ft)	Opening Height (ft)	Wind Pressure (PSF) And Deflection Limits																											
			5 psf			15 psf			20 psf			25 psf			30 psf			35 psf			40 psf			45 psf			50 psf			
			L/120	L/240	L/360	L/240	L/360	L/600	L/240	L/360	L/600	L/240	L/360	L/600	L/240	L/360	L/600	L/240	L/360	L/600	L/240	L/360	L/600	L/240	L/360	L/600				
400JAM250-54, 50ksi	9	6	12'4" f	10'0" d	8'9" d	10'3" f	9'10" d	8'3" d	9'6" f	9'6" f	8'3" d	9'0" f	9'0" f	8'3" d	8'6" f	8'6" f	8'0" d	8'1" f	8'1" f	7'7" d	7'9" f	7'9" f	7'4" d	7'6" f	7'6" f	7'1" d	7'3" f	7'3" f	6'10" d	
		8	17'5" f	14'5" d	12'7" d	12'10" f	12'0" d	10'4" d	11'8" f	11'0" d	9'6" d	10'9" f	10'4" d	8'11" d	10'1" f	9'9" d	8'6" d	9'7" f	9'4" d	8'2" d	9'2" f	9'0" d	7'10" d	8'9" f	8'9" f	7'7" d	8'6" f	8'6" f	7'5" d	
	11	8	12'2" f	10'0" d	8'9" d	9'11" f	9'10" d	8'3" d	9'3" f	9'3" f	8'3" d	8'9" f	8'9" f	8'3" d	8'4" f	8'4" f	7'10" d	8'0" f	8'0" f	7'6" d	7'8" f	7'8" f	7'3" d	7'5" f	7'5" f	7'0" d	7'2" f	7'2" f	6'10" d	
		10	17'0" f	14'5" d	12'7" d	12'4" f	11'8" d	10'2" d	11'3" f	10'9" d	9'5" d	10'6" f	10'2" d	8'11" d	9'11" f	9'8" d	8'6" d	9'6" f	9'3" d	8'2" d	9'1" f	9'0" d	7'10" d	8'9" f	8'8" d	7'7" d	8'5" f	8'5" f	7'5" d	
	13	8	9'10" f	8'5" d	7'4" d	8'5" f	8'3" d	7'0" d	7'11" f	7'11" f	7'0" d	7'7" f	7'7" f	7'0" d	7'3" f	7'3" f	7'0" d	6'11" f	6'11" f	6'11" f	6'8" f	6'8" f	6'8" f	6'6" f	6'6" f	6'6" f	6'3" f	6'3" f	6'3" f	
		10	12'1" f	10'0" d	8'9" d	9'10" f	9'10" f	8'3" d	9'3" f	9'3" f	8'3" d	8'9" f	8'9" f	8'3" d	8'4" f	8'4" f	7'10" d	8'0" f	8'0" f	7'6" d	7'8" f	7'8" f	7'3" d	7'5" f	7'5" f	7'0" d	7'2" f	7'2" f	6'10" d	
		12	16'7" f	14'5" d	12'7" d	12'2" f	11'7" d	10'2" d	11'3" f	10'9" d	9'5" d	10'6" f	10'2" d	8'11" d	9'11" f	9'8" d	8'6" d	9'6" f	9'4" d	8'2" d	9'1" f	9'0" d	7'10" d	8'9" f	8'8" d	7'7" d	8'5" f	8'5" f	7'5" d	
	15	8	8'6" f	7'6" d	6'7" d	7'5" f	7'5" f	6'3" d	7'0" f	7'0" f	6'3" d	6'9" f	6'9" f	6'3" d	6'5" f	6'5" f	6'3" d	6'2" f	6'2" f	6'2" f	6'0" f	6'0" f	6'0" f	5'9" f	5'9" f	5'9" f	5'7" f	5'7" f	5'7" f	
		10	9'10" f	8'5" d	7'4" d	8'5" f	8'3" d	7'0" d	7'11" f	7'11" f	7'0" d	7'7" f	7'7" f	7'0" d	7'3" f	7'3" f	7'0" d	6'11" f	6'11" f	6'11" f	6'8" f	6'8" f	6'8" f	6'6" f	6'6" f	6'6" f	6'3" f	6'3" f	6'3" f	
		12	12'0" f	10'0" d	8'9" d	9'10" f	9'10" f	8'3" d	9'3" f	9'3" f	8'3" d	8'9" f	8'9" f	8'3" d	8'4" f	8'4" f	7'10" d	8'0" f	8'0" f	7'6" d	7'8" f	7'8" f	7'3" d	7'5" f	7'5" f	7'0" d	7'2" f	7'2" f	6'10" d	
	400JAM250-68, 50ksi	9	6	13'6" d	10'9" d	9'5" d	11'6" f	10'7" d	8'11" d	10'9" f	10'7" d	8'11" d	10'1" f	10'1" f	8'11" d	9'7" f	9'7" f	8'6" d	9'1" f	9'1" f	8'1" d	8'9" f	8'9" f	7'10" d	8'5" f	8'5" f	7'6" d	8'1" f	8'1" f	7'3" d
			8	19'7" d	15'6" d	13'6" d	14'5" f	12'9" d	11'0" d	13'1" f	11'9" d	10'1" d	12'1" f	11'0" d	9'6" d	11'4" f	10'5" d	9'0" d	10'8" f	9'11" d	8'7" d	10'2" f	9'7" d	8'4" d	9'9" f	9'3" d	8'1" d	8'5" f	9'0" d	7'10" d
11		8	13'6" d	10'9" d	9'5" d	11'2" f	10'7" d	8'11" d	10'4" f	10'4" f	8'11" d	9'9" f	9'9" f	8'9" d	9'3" f	9'3" f	8'4" d	8'10" f	8'10" f	8'0" d	8'6" f	8'6" f	7'8" d	8'3" f	8'3" f	7'5" d	7'11" f	7'11" f	7'3" d	
		10	19'1" f	15'6" d	13'6" d	13'10" f	12'5" d	10'9" d	12'7" f	11'5" d	9'11" d	11'8" f	10'9" d	9'5" d	11'0" f	10'3" d	9'0" d	10'5" f	9'10" d	8'7" d	10'0" f	9'6" d	8'4" d	9'7" f	9'2" d	8'1" d	9'4" f	9'0" d	7'10" d	
13		8	11'0" f	9'1" d	7'11" d	9'5" f	8'11" d	7'6" d	8'10" f	8'10" f	7'6" d	8'5" f	8'5" f	7'6" d	8'1" f	8'1" f	7'6" d	7'9" f	7'9" f	7'6" d	7'6" f	7'6" f	7'3" d	7'3" f	7'3" f	7'0" d	7'0" f	7'0" f	6'9" d	
		10	13'6" f	10'9" d	9'5" d	11'0" f	10'7" d	8'11" d	10'3" f	10'3" f	8'11" d	9'8" f	9'8" f	8'9" d	9'3" f	9'3" f	8'4" d	8'10" f	8'10" f	8'0" d	8'6" f	8'6" f	7'8" d	8'3" f	8'3" f	7'5" d	7'11" f	7'11" f	7'3" d	
		12	18'6" f	15'6" d	13'6" d	13'6" f	12'3" d	10'9" d	12'4" f	11'4" d	9'11" d	11'7" f	10'9" d	9'5" d	11'1" f	10'3" d	9'0" d	10'5" f	9'10" d	8'7" d	10'0" f	9'6" d	8'4" d	9'7" f	9'3" d	8'1" d	9'4" f	9'0" d	7'10" d	
15		8	9'6" f	8'1" d	7'1" d	8'3" f	7'11" d	6'8" d	7'10" f	7'10" f	6'8" d	7'6" f	7'6" f	6'8" d	7'2" f	7'2" f	6'8" d	6'11" f	6'11" f	6'8" d	6'8" f	6'8" f	6'8" f	6'6" f	6'6" f	6'6" f	6'4" f	6'4" f	6'4" f	
		10	11'0" f	9'1" d	7'11" d	9'4" f	8'11" d	7'6" d	8'10" f	8'10" f	7'6" d	8'5" f	8'5" f	7'6" d	8'1" f	8'1" f	7'6" d	7'9" f	7'9" f	7'6" d	7'6" f	7'6" f	7'3" d	7'3" f	7'3" f	7'0" d	7'0" f	7'0" f	6'9" d	
		12	13'4" f	10'9" d	9'5" d	10'11" f	10'7" d	8'11" d	10'3" f	10'3" f	8'11" d	9'8" f	9'8" f	8'9" d	9'3" f	9'3" f	8'4" d	8'10" f	8'10" f	8'0" d	8'6" f	8'6" f	7'8" d	8'3" f	8'3" f	7'5" d	7'11" f	7'11" f	7'3" d	
400JAM250-97, 50ksi		9	6	15'1" d	12'0" d	10'5" d	13'6" d	11'9" d	9'11" d	13'1" f	11'9" d	9'11" d	12'4" f	11'9" d	9'11" d	11'10" f	11'1" d	9'5" d	11'4" f	10'6" d	9'0" d	10'10" f	10'1" d	8'7" d	10'5" f	9'9" d	8'4" d	10'1" f	9'5" d	8'0" d
			8	21'10" d	17'3" d	15'1" d	15'11" d	14'1" d	12'1" d	14'8" d	12'11" d	11'1" d	13'8" d	12'1" d	10'5" d	12'11" d	11'5" d	9'10" d	12'4" d	10'11" d	9'5" d	11'10" d	10'6" d	9'1" d	11'5" d	10'2" d	8'10" d	11'1" d	9'10" d	8'7" d
	11	8	15'1" d	12'0" d	10'5" d	13'6" d	11'9" d	9'11" d	12'9" f	11'9" d	9'11" d	12'0" f	11'3" d	9'8" d	11'5" f	10'8" d	9'2" d	10'10" f	10'2" d	8'9" d	10'5" f	9'9" d	8'5" d	10'1" f	9'5" d	8'2" d	9'9" f	9'2" d	7'11" d	
		10	21'10" d	17'3" d	15'1" d	15'4" d	13'7" d	11'9" d	14'1" d	12'6" d	10'10" d	13'2" d	11'9" d	10'3" d	12'6" d	11'2" d	9'9" d	12'0" d	10'9" d	9'4" d	11'6" d	10'4" d	9'1" d	11'2" d	10'0" d	8'9" d	10'10" d	9'9" d	8'6" d	
	13	8	12'9" d	10'1" d	8'10" d	11'4" d	9'11" d	8'4" d	10'9" f	9'11" d	8'4" d	10'3" f	9'11" d	8'4" d	9'10" f	9'10" f	8'4" d	9'5" f	9'5" f	8'3" d	9'1" f	9'1" f	8'11" d	8'9" f	8'9" f	7'8" d	8'6" f	8'6" f	7'5" d	
		10	15'1" d	12'0" d	10'5" d	13'4" f	11'9" d	9'11" d	12'5" f	11'9" d	9'11" d	11'9" f	11'1" d	9'7" d	11'2" f	10'6" d	9'1" d	10'8" f	10'1" d	8'9" d	10'3" f	9'8" d	8'5" d	9'11" f	9'5" d	8'2" d	8'7" f	9'1" d	7'11" d	
		12	21'10" d	17'3" d	15'1" d	14'11" d	13'4" d	11'8" d	13'9" d	12'4" d	10'10" d	13'0" d	11'8" d	10'3" d	12'4" d	11'2" d	9'9" d	11'10" d	10'8" d	9'4" d	11'6" d	10'4" d	9'1" d	11'2" d	10'0" d	8'9" d	10'10" d	9'9" d	8'6" d	
	15	8	11'4" f	9'0" d	7'10" d	10'0" f	8'10" d	7'6" d	9'6" f	8'10" d	7'6" d	9'1" f	8'10" d	7'6" d	8'9" f	8'9" f	7'6" d	8'5" f	8'5" f	7'6" d	8'2" f	8'2" f	7'6" d	7'11" f	7'11" f	7'3" d	7'8" f	7'8" f	7'0" d	
		10	12'9" d	10'1" d	8'10" d	11'3" f	9'11" d	8'4" d	10'8" f	9'11" d	8'4" d	10'2" f	9'11" d	8'4" d	9'9" f	9'9" f	8'4" d	9'4" f	9'4" f	8'3" d	9'1" f	9'1" f	7'11" d	8'9" f	8'9" f	7'8" d	8'6" f	8'6" f	7'5" d	
		12	15'1" d	12'0" d	10'5" d	13'2" f	11'9" d	9'11" d	12'4" f	11'8" d	9'11" d	11'8" f	11'0" d	9'7" d	11'1" f	10'6" d	9'1" d	10'8" f	10'1" d	8'9" d	10'3" f	9'8" d	8'5" d	9'11" f	9'5" d	8'2" d	9'7" f	9'1" d	7'11" d	
	400JAM350-68, 50ksi	9	6	16'9" f	14'1" d	12'4" d	13'0" f	13'0" f	11'5" d	16'9" f	11'11" f	10'5" d	11'3" f	11'3" f	9'9" d	10'6" f	10'6" f	9'2" d	10'0" f	10'0" f	8'9" d	9'6" f	9'6" f	8'5" d	9'1" f	9'1" f	8'1" d	8'9" f	8'9" f	7'10" d
			8	22'6" f	19'5" d	16'11" d	15'8" f	13'9" d	11'10" d	14'0" f	12'7" d	10'10" d	12'10" f	11'10" d	10'2" d	12'0" f	11'2" d	9'8" d	11'3" f	10'8" d	9'3" d	10'8" f	10'3" d	8'11" d	10'3" f	9'11" d	8'7" d	9'10" f	9'8" d	8'4" d
11		8	16'2" f	14'1" d	12'4" d	12'7" f	12'7" f	11'0" d	11'6" f	11'6" f	10'1" d	10'9" f	10'9" f	9'5" d	10'1" f	10'1" f	8'11" d	9'7" f	9'7" f	8'7" d	9'2" f	9'2" f	8'3" d	8'10" f	8'10" f	8'0" d	8'6" f	8'6" f	7'9" d	
		10	21'1" f	18'10" d	16'7" d	14'10" f	13'3" d	11'6" d	13'4" f	12'3" d	10'7" d	12'4" f	11'6" d	10'0" d	11'6" f	10'11" d	9'7" d	10'11" f	10'6" d	9'2" d	10'5" f	10'1" d	8'10" d	10'0" f	9'10" d	8'7" d	9'8" f	9'7" d	8'4" d	
13		8	13'5" f	11'10" d	10'4" d	10'10" f	10'10" f	9'10" d	10'0" f	10'0" f	9'6" d	9'5" f	9'5" f	8'11" d	8'11" f	8'5" d	8'6" f	8'6" f	8'1" d	8'2" f	8'2" f	7'9" d	7'10" f	7'10" f	7'6" d	7'7" f	7'7" f	7'3" d		
		10	16'0" f	14'1" d	12'4" d	12'3" f	12'3" f	10'10" d	11'3" f	11'3" f	10'0" d	10'6" f	10'6" f	9'5" d	10'0" f	10'0" f	8'11" d	9'6" f	9'6" f	8'7" d	9'1" f	9'1" f	8'3" d	8'9" f	8'9" f	8'0" d	8'6" f	8'6" f	7'9" d	
		12	20'9" f	18'2" d	16'1" d	14'4" f	13'1" d	11'5" d	13'0" f	12'1" d	10'7" d	12'1" f	11'5" d	10'0" d	11'5" f	10'11" d	9'7" d	10'11" f	10'6" d	9'2" d	10'5" f	10'1" d	8'10" d	10'0" f	9'10" d	8'7" d	9'8" f	9'7" d	8'4" d	
15		8	11'8" f	10'7" d	9'3" d	9'7" f	9'7" f	8'10" d	9'0" f	9'0" f	8'10" d	8'6" f	8'6" f	8'5" d	8'1" f	8'1" f														

Refer to Important Table Notes on Page 33

Section	Wall Ht. (ft)	Opening Height (ft)	Wind Pressure (PSF) And Deflection Limits																											
			5 psf			15 psf			20 psf			25 psf			30 psf			35 psf			40 psf			45 psf			50 psf			
			L/120	L/240	L/360	L/240	L/360	L/600	L/240	L/360	L/600	L/240	L/360	L/600	L/240	L/360	L/600	L/240	L/360	L/600	L/240	L/360	L/600	L/240	L/360	L/600	L/240	L/360	L/600	
600-JAM250-54, 50ksi	9	6	12'0"	10'6"	9'2"	10'8"	10'4"	8'9"	10'1"	10'1"	8'9"	9'8"	9'8"	8'9"	9'3"	9'3"	8'9"	8'11"	8'11"	8'9"	8'7"	8'7"	8'7"	8'4"	8'4"	8'4"	8'1"	8'1"	8'1"	
		8	18'3"	15'2"	13'3"	14'5"	14'5"	12'7"	13'3"	13'3"	12'6"	12'4"	12'4"	11'8"	11'8"	11'1"	11'1"	11'1"	10'7"	10'7"	10'7"	10'2"	10'2"	10'2"	10'2"	10'2"	9'10"	9'10"	9'6"	
	11	8	11'11"	10'6"	9'2"	10'5"	10'4"	8'9"	9'11"	9'11"	8'9"	9'5"	9'5"	8'9"	9'1"	9'1"	8'9"	8'9"	8'9"	8'9"	8'5"	8'5"	8'5"	8'2"	8'2"	8'2"	8'0"	8'0"	8'0"	
		10	17'11"	15'2"	13'3"	13'10"	13'10"	12'7"	12'9"	12'9"	12'1"	11'11"	11'11"	11'5"	11'3"	11'3"	10'10"	10'9"	10'9"	10'5"	10'4"	10'4"	10'0"	10'0"	10'0"	9'9"	9'8"	9'8"	9'6"	
	13	8	9'6"	8'10"	7'9"	8'7"	8'7"	7'4"	8'3"	8'3"	7'4"	7'11"	7'11"	7'4"	7'8"	7'8"	7'4"	7'5"	7'5"	7'4"	7'3"	7'3"	7'3"	7'1"	7'1"	7'1"	6'10"	6'10"	6'10"	
		10	11'10"	10'6"	9'2"	10'4"	10'4"	8'9"	9'10"	9'10"	8'9"	9'5"	9'5"	8'9"	9'0"	9'0"	8'9"	8'9"	8'9"	8'9"	8'5"	8'5"	8'5"	8'2"	8'2"	8'2"	8'0"	8'0"	8'0"	
	15	8	8'1"	7'11"	6'11"	7'5"	7'5"	6'7"	7'2"	7'2"	6'7"	6'11"	6'11"	6'7"	6'9"	6'9"	6'7"	6'7"	6'7"	6'7"	6'5"	6'5"	6'5"	6'3"	6'3"	6'3"	6'1"	6'1"	6'1"	
		10	9'5"	8'10"	7'9"	8'7"	8'7"	7'4"	8'3"	8'3"	7'4"	7'11"	7'11"	7'4"	7'8"	7'8"	7'4"	7'5"	7'5"	7'4"	7'3"	7'3"	7'3"	7'1"	7'1"	7'1"	6'10"	6'10"	6'10"	
	600-JAM250-68, 50ksi	9	6	14'3"	11'4"	9'10"	12'5"	11'1"	9'4"	11'11"	11'1"	9'4"	11'4"	11'1"	9'4"	10'10"	10'10"	9'4"	10'5"	10'5"	9'4"	10'1"	10'1"	9'4"	9'9"	9'9"	9'4"	9'5"	9'5"	9'4"
			8	20'7"	16'4"	14'3"	16'6"	16'1"	13'6"	15'5"	15'5"	13'4"	14'4"	14'4"	12'6"	13'6"	13'6"	11'10"	12'9"	12'9"	11'3"	12'2"	12'2"	10'10"	11'8"	11'8"	10'6"	11'3"	11'3"	10'2"
		11	8	14'1"	11'4"	9'10"	12'3"	11'1"	9'4"	11'7"	11'1"	9'4"	11'0"	11'0"	9'4"	10'6"	10'6"	9'4"	10'1"	10'1"	9'4"	9'9"	9'9"	9'4"	9'5"	9'5"	9'4"	9'2"	9'2"	9'2"
			10	20'7"	16'4"	14'3"	16'1"	16'1"	13'6"	14'9"	14'9"	12'11"	13'8"	13'8"	12'1"	12'11"	12'11"	11'6"	12'3"	12'3"	11'0"	11'9"	11'9"	10'8"	11'3"	11'3"	10'4"	10'11"	10'11"	10'0"
13		8	11'2"	9'6"	8'4"	10'1"	9'4"	7'11"	9'7"	9'4"	7'11"	9'3"	9'3"	7'11"	8'11"	8'11"	7'11"	8'8"	8'8"	7'11"	8'5"	8'5"	7'11"	8'2"	8'2"	7'11"	7'11"	7'11"	7'11"	
		10	13'11"	11'4"	9'10"	12'0"	11'1"	9'4"	11'4"	11'1"	9'4"	10'10"	10'10"	9'4"	10'5"	10'5"	9'4"	10'0"	10'0"	9'4"	9'8"	9'8"	9'4"	9'5"	9'5"	9'4"	9'2"	9'2"	9'2"	
15		8	9'7"	8'6"	7'5"	8'9"	8'4"	7'1"	8'5"	8'4"	7'1"	8'2"	8'2"	7'1"	7'11"	7'11"	7'1"	7'8"	7'8"	7'1"	7'5"	7'5"	7'1"	7'3"	7'3"	7'3"	7'1"	7'1"	7'1"	
		10	11'2"	9'6"	8'4"	10'0"	9'4"	7'11"	9'7"	9'4"	7'11"	9'3"	9'3"	7'11"	8'11"	8'11"	7'11"	8'7"	8'7"	7'11"	8'5"	8'5"	7'11"	8'2"	8'2"	7'11"	7'11"	7'11"	7'11"	
600-JAM250-97, 50ksi		9	6	15'11"	12'7"	11'0"	14'2"	12'5"	10'5"	14'2"	12'5"	10'5"	14'2"	12'5"	10'5"	13'8"	12'5"	10'5"	13'1"	12'5"	10'5"	12'8"	12'5"	10'5"	12'3"	12'3"	10'5"	11'11"	11'11"	10'5"
			8	22'11"	18'2"	15'11"	20'6"	17'11"	15'1"	19'4"	16'11"	14'9"	17'11"	15'11"	13'10"	16'9"	15'3"	13'1"	15'11"	14'7"	12'5"	15'6"	14'0"	11'11"	14'10"	13'6"	11'7"	14'3"	13'1"	11'2"
		11	8	15'11"	12'7"	11'0"	14'2"	12'5"	10'5"	14'2"	12'5"	10'5"	13'11"	12'5"	10'5"	13'3"	12'5"	10'5"	12'9"	12'5"	10'5"	12'4"	12'4"	10'5"	11'11"	11'11"	10'5"	11'6"	11'6"	10'5"
			10	22'11"	18'2"	15'11"	19'11"	17'11"	15'1"	18'7"	16'7"	14'2"	17'4"	15'6"	13'4"	16'3"	14'8"	12'7"	15'5"	14'0"	12'1"	14'8"	13'6"	11'8"	14'1"	13'0"	11'3"	13'6"	12'7"	10'11"
	13	8	13'5"	10'7"	9'3"	12'0"	10'5"	8'10"	12'0"	10'5"	8'10"	11'8"	10'5"	8'10"	11'3"	10'5"	8'10"	10'10"	10'5"	8'10"	10'6"	10'5"	8'10"	10'3"	10'3"	8'10"	9'11"	9'11"	8'10"	
		10	15'11"	12'7"	11'0"	14'2"	12'5"	10'5"	14'2"	12'5"	10'5"	13'6"	12'5"	10'5"	12'11"	12'5"	10'5"	12'5"	12'5"	10'5"	12'0"	12'0"	10'5"	11'7"	11'7"	10'5"	11'3"	11'3"	10'3"	
	15	8	12'0"	9'6"	8'3"	10'8"	9'4"	7'10"	10'7"	9'4"	7'10"	10'3"	9'4"	7'10"	9'11"	9'4"	7'10"	9'7"	9'4"	7'10"	9'4"	9'4"	7'10"	9'1"	9'1"	7'10"	8'11"	8'11"	7'10"	
		10	13'5"	10'7"	9'3"	12'0"	10'5"	8'10"	11'11"	10'5"	8'10"	11'6"	10'5"	8'10"	11'1"	10'5"	8'10"	10'9"	10'5"	8'10"	10'5"	10'5"	8'10"	10'2"	10'2"	8'10"	9'10"	9'10"	8'10"	
	600-JAM250-118, 50ksi	9	6	16'10"	13'4"	11'8"	15'1"	13'2"	11'1"	15'1"	13'2"	11'1"	15'1"	13'2"	11'1"	15'1"	13'2"	11'1"	14'7"	13'2"	11'1"	14'1"	13'2"	11'1"	13'7"	13'2"	11'1"	13'2"	11'1"	11'1"
			8	24'4"	19'4"	16'10"	21'9"	19'0"	16'0"	20'7"	18'0"	15'8"	19'1"	16'8"	14'7"	18'0"	15'11"	13'10"	17'1"	15'5"	13'2"	16'4"	14'9"	12'8"	15'7"	14'3"	12'2"	15'8"	13'10"	11'10"
		11	8	16'10"	13'4"	11'8"	15'1"	13'2"	11'1"	15'1"	13'2"	11'1"	15'1"	13'2"	11'1"	14'8"	13'2"	11'1"	14'1"	13'2"	11'1"	13'7"	13'2"	11'1"	13'2"	13'2"	11'1"	12'9"	12'9"	11'0"
			10	24'4"	19'4"	16'10"	21'2"	19'0"	16'0"	19'10"	17'6"	15'0"	18'6"	16'4"	14'0"	17'6"	15'6"	13'4"	16'8"	14'9"	12'9"	16'0"	14'2"	12'3"	15'6"	13'9"	11'10"	14'11"	13'4"	11'6"
13		8	14'3"	11'3"	9'10"	12'8"	11'1"	9'4"	12'8"	11'1"	9'4"	12'8"	11'1"	9'4"	12'4"	11'1"	9'4"	12'0"	11'1"	9'4"	11'7"	11'1"	9'4"	11'3"	11'1"	9'4"	11'0"	11'0"	9'4"	
		10	16'10"	13'4"	11'8"	15'1"	13'2"	11'1"	15'1"	13'2"	11'1"	14'11"	13'2"	11'1"	14'3"	13'2"	11'1"	13'8"	13'2"	11'1"	13'2"	13'2"	11'1"	12'9"	12'9"	11'1"	12'5"	12'5"	10'10"	
15		8	12'8"	10'1"	8'10"	11'4"	9'11"	8'4"	11'4"	9'11"	8'4"	11'3"	9'11"	8'4"	10'11"	9'11"	8'4"	10'7"	9'11"	8'4"	10'3"	9'11"	8'4"	10'0"	9'11"	8'4"	9'9"	9'9"	8'4"	
		10	14'3"	11'3"	9'10"	12'8"	11'1"	9'4"	12'8"	11'1"	9'4"	12'7"	11'1"	9'4"	12'2"	11'1"	9'4"	11'9"	11'1"	9'4"	11'5"	11'1"	9'4"	11'1"	11'1"	9'4"	10'10"	10'10"	9'4"	
600-JAM350-68, 50ksi		9	6	17'9"	14'10"	12'11"	14'9"	14'7"	12'3"	13'9"	13'9"	12'3"	12'11"	12'11"	12'3"	12'2"	12'2"	12'0"	11'10"	11'10"	11'8"	11'4"	11'4"	11'2"	10'11"	10'11"	10'9"	10'6"	10'6"	10'5"
			8	25'7"	21'5"	18'8"	18'5"	18'0"	15'8"	16'6"	16'4"	14'3"	15'8"	15'8"	13'4"	14'7"	14'7"	12'7"	13'9"	13'9"	12'0"	13'1"	13'1"	11'7"	12'6"	12'6"	11'2"	12'0"	12'0"	10'10"
		11	8	17'4"	14'10"	12'11"	14'4"	14'4"	12'3"	13'4"	13'4"	12'3"	12'6"	12'6"	12'3"	11'10"	11'10"	11'9"	11'4"	11'4"	11'3"	10'10"	10'10"	10'9"	10'5"	10'5"	10'5"	10'1"	10'1"	10'1"
			10	24'4"	21'5"	18'8"	17'9"	17'6"	15'0"	16'1"	16'0"	13'9"	14'10"	14'10"	12'11"	13'10"	13'10"	12'3"	13'1"	13'1"	11'9"	12'6"	12'6"	11'3"	11'11"	11'11"	10'11"	11'6"	11'6"	10'7"
	13	8	14'0"	12'6"	10'11"	12'0"	12'0"	10'4"	11'4"	11'4"	10'4"	10'9"	10'9"	10'4"	10'3"	10'3"	10'3"	9'10"	9'10"	9'10"	9'6"	9'6"	9'6"	9'2"	9'2"	9'2"	8'10"	8'10"	8'10"	
		10	17'2"	14'10"	12'11"	13'11"	13'11"	12'3"	13'0"	13'0"	12'3"	12'2"	12'2"	12'2"	11'7"	11'7"	11'6"	11'1"	11'1"	11'0"	10'8"	10'8"	10'7"	10'3"	10'3"	10'3"	9'11"	9'11"	9'11"	
	15	8	12'1"	11'2"	9'9"	10'7"	10'7"	9'3"	10'0"	10'0"	9'3"	9'7"	9'7"	9'3"	9'2"	9'2"	9'2"	8'10"	8'10"	8'10"	8'6"	8'6"	8'6"	8'3"	8'3"	8'3"	8'0"	8'0"	8'0"	
		10	13'11"	12'6"	10'11"	11'10"	11'10"	10'4"	11'2"	11'2"	10'4"	10'7"	10'7"	10'4"	10'2"	10'2"	10'2"	9'9"	9'9"	9'9"	9'5"	9'5"	9'5"	9'1"	9'1"	9'1"	8'10"	8'10"	8'10"	
	600-JAM350-97, 50ksi	9	6	20'10"	16'7"	14'6"	18'5"	16'3"	13'9"	17'2"	16'3"	13'9"	16'2"	16'2"	13'9"	15'3"	15'3"	13'5"	14'6"	14'6"	12'9"	13'11"	13'11"	12'2"	13'4"	13'4"	11'11"	12'10"	12'10"	11'7"
			8	30'1"	23'11"	20'10"	23'0"	20'1"	16'11"	20'9"	18'3"	15'10"	19'0"	16'11"	14'9"	17'8"	15'11"	14'0"	16'6"	15'7"	13'4"	15'11"	15'0"	12'10"	15'4"	14'5"	12'4"	14'9"	14'0"	12'0"
		11	8	20'10"	16'7"	14'6"	17'7"	16'3"	13'9"	16'3"	16'3"	13'9"	15'6"	15'6"	13'9"	14'8"	14'8"	13'0"	14'0"	14'0"	12'5"	13'4"	13'4"	11'11"	12'10"	12'10"	11'6"	12'5"	12'5"	11'2"
			10	30'1"	23'11"	20'10"	21'6"	19'5"	16'7"	19'10"	17'9"	15'2"	18'2"	16'7"	14'3"	17'0"	15'8"	13'6"	16'0"	15'0"	12'11"	15'2"	14'5"	12'5"	14'6"	13'11"	12'0"	13'11"	13'6"	11'8"
13		8	17'4"	14'0"	12'2"	14'11"	13'9"	11'7"	14'0"	13'9"	11'7"	13'3"	13'3"	11'7"	12'8"	12'8"	11'7"	12'1"												

# Exterior Wall Framing & Accessories JamStud® Non Load Bearing Opening Allowable Header Spans

Refer to Important Table Notes on Page 33

Section	Wall Ht. (ft)	Opening Height (ft)	Wind Pressure (PSF) And Deflection Limits																											
			5 psf			15 psf			20 psf			25 psf			30 psf			35 psf			40 psf			45 psf			50 psf			
			L/120	L/240	L/360	L/240	L/360	L/600	L/240	L/360	L/600	L/240	L/360	L/600	L/240	L/360	L/600	L/240	L/360	L/600	L/240	L/360	L/600	L/240	L/360	L/600	L/240	L/360	L/600	
600JAM350-118, 50ksi	9	6	22'2"	17'7"	15'4"	19'10"	17'4"	14'7"	19'3"	17'4"	14'7"	18'2"	17'4"	14'7"	17'3"	16'11"	14'3"	16'5"	16'1"	13'7"	15'8"	15'5"	13'0"	15'1"	14'9"	12'6"	14'6"	14'3"	12'0"	
		8	32'0"	25'5"	22'2"	24'5"	21'4"	18'0"	22'3"	19'5"	16'4"	20'7"	18'0"	15'8"	19'5"	16'11"	14'10"	18'5"	16'1"	14'1"	17'7"	15'10"	13'6"	16'11"	15'3"	13'1"	16'1"	14'10"	12'8"	
		10	32'0"	25'5"	22'2"	22'10"	20'0"	17'6"	18'3"	17'4"	14'7"	17'1"	16'10"	14'7"	16'2"	15'11"	13'10"	15'8"	15'5"	13'2"	15'0"	14'10"	12'7"	14'5"	14'3"	12'2"	13'11"	13'10"	11'9"	
	11	8	18'8"	14'10"	12'11"	16'5"	14'7"	12'4"	15'8"	14'7"	12'4"	14'10"	14'7"	12'4"	14'2"	14'2"	12'4"	13'7"	13'7"	12'4"	13'1"	13'1"	11'11"	12'7"	12'7"	11'6"	12'2"	12'2"	11'1"	
		10	22'2"	17'7"	15'4"	19'3"	17'4"	14'7"	17'10"	17'4"	14'7"	16'9"	16'6"	14'2"	15'10"	15'8"	13'5"	15'1"	14'11"	12'10"	14'5"	14'4"	12'4"	13'11"	13'10"	11'11"	13'5"	13'5"	11'6"	
		12	32'0"	25'5"	22'2"	22'5"	19'9"	17'0"	20'6"	18'2"	15'7"	19'2"	17'0"	14'8"	18'2"	16'1"	13'11"	17'3"	15'5"	13'4"	16'5"	14'10"	12'10"	15'8"	14'4"	12'6"	15'1"	13'11"	12'2"	
	13	8	16'6"	13'3"	11'7"	14'7"	13'1"	11'0"	13'10"	13'1"	11'0"	13'2"	13'1"	11'0"	12'7"	12'7"	11'0"	12'2"	12'2"	11'0"	11'9"	11'9"	11'0"	11'4"	11'4"	10'11"	11'0"	11'0"	10'7"	
		10	18'8"	14'10"	12'11"	16'3"	14'7"	12'4"	15'4"	14'7"	12'4"	14'6"	14'6"	12'4"	13'10"	13'10"	12'4"	13'3"	13'3"	12'2"	12'9"	12'9"	11'8"	12'4"	12'4"	11'3"	11'11"	11'11"	10'11"	
		12	22'2"	17'7"	15'4"	18'9"	17'4"	14'7"	17'5"	17'3"	14'7"	16'4"	16'2"	13'11"	15'5"	15'3"	13'2"	14'9"	14'7"	12'8"	14'2"	14'1"	12'2"	13'7"	13'7"	11'10"	13'2"	13'2"	11'6"	
	800JAM250-43, 50ksi	9	6	9'2"	9'2"	8'10"	8'6"	8'6"	8'4"	8'3"	8'3"	8'3"	8'0"	8'0"	8'0"	7'10"	7'10"	7'10"	7'7"	7'7"	7'7"	7'5"	7'5"	7'5"	7'3"	7'3"	7'3"	7'1"	7'1"	7'1"
			8	14'9"	14'7"	12'9"	12'6"	12'6"	12'1"	11'9"	11'9"	11'9"	11'1"	11'1"	11'1"	10'7"	10'7"	10'7"	10'2"	10'2"	10'2"	9'10"	9'10"	9'10"	9'6"	9'6"	9'6"	9'2"	9'2"	9'2"
			10	14'6"	14'6"	12'9"	12'2"	12'2"	12'1"	11'6"	11'6"	11'6"	10'11"	10'11"	10'11"	10'5"	10'5"	10'5"	10'0"	10'0"	10'0"	9'8"	9'8"	9'8"	9'5"	9'5"	9'5"	9'2"	9'2"	9'2"
11		8	9'2"	9'2"	8'10"	8'5"	8'5"	8'4"	8'2"	8'2"	8'2"	7'11"	7'11"	7'11"	7'9"	7'9"	7'9"	7'6"	7'6"	7'6"	7'4"	7'4"	7'4"	7'2"	7'2"	7'2"	7'1"	7'1"	7'1"	
		10	14'6"	14'6"	12'9"	12'2"	12'2"	12'1"	11'6"	11'6"	11'6"	10'11"	10'11"	10'11"	10'5"	10'5"	10'5"	10'0"	10'0"	10'0"	9'8"	9'8"	9'8"	9'5"	9'5"	9'5"	9'2"	9'2"	9'2"	
		12	14'5"	14'5"	12'9"	12'1"	12'1"	12'1"	11'5"	11'5"	11'5"	10'10"	10'10"	10'10"	10'5"	10'5"	10'5"	10'0"	10'0"	10'0"	9'8"	9'8"	9'8"	9'5"	9'5"	9'5"	9'2"	9'2"	9'2"	
13		8	7'2"	7'2"	7'2"	6'10"	6'10"	6'10"	6'8"	6'8"	6'8"	6'6"	6'6"	6'6"	6'4"	6'4"	6'4"	6'3"	6'3"	6'3"	6'1"	6'1"	6'1"	6'0"	6'0"	6'0"	5'11"	5'11"	5'11"	
		10	9'2"	9'2"	8'10"	8'5"	8'5"	8'4"	8'2"	8'2"	8'2"	7'11"	7'11"	7'11"	7'9"	7'9"	7'9"	7'6"	7'6"	7'6"	7'4"	7'4"	7'4"	7'2"	7'2"	7'2"	7'1"	7'1"	7'1"	
		12	14'5"	14'5"	12'9"	12'1"	12'1"	12'1"	11'5"	11'5"	11'5"	10'10"	10'10"	10'10"	10'5"	10'5"	10'5"	10'0"	10'0"	10'0"	9'8"	9'8"	9'8"	9'5"	9'5"	9'5"	9'2"	9'2"	9'2"	
15		8	6'1"	6'1"	6'1"	5'10"	5'10"	5'10"	5'8"	5'8"	5'8"	5'7"	5'7"	5'7"	5'6"	5'6"	5'6"	5'5"	5'5"	5'5"	5'4"	5'4"	5'4"	5'3"	5'3"	5'3"	5'2"	5'2"	5'2"	
		10	7'2"	7'2"	7'2"	6'10"	6'10"	6'10"	6'8"	6'8"	6'8"	6'6"	6'6"	6'6"	6'4"	6'4"	6'4"	6'3"	6'3"	6'3"	6'1"	6'1"	6'1"	6'0"	6'0"	6'0"	5'11"	5'11"	5'11"	
		12	9'2"	9'2"	8'10"	8'5"	8'5"	8'4"	8'2"	8'2"	8'2"	7'11"	7'11"	7'11"	7'9"	7'9"	7'9"	7'6"	7'6"	7'6"	7'4"	7'4"	7'4"	7'2"	7'2"	7'2"	7'1"	7'1"	7'1"	
800JAM250-54, 50ksi	9	6	11'1"	10'10"	9'6"	10'3"	10'3"	9'0"	9'10"	9'10"	9'0"	9'7"	9'7"	9'0"	9'3"	9'3"	9'0"	9'0"	9'0"	9'0"	8'9"	8'9"	8'9"	8'7"	8'7"	8'7"	8'4"	8'4"	8'4"	
		8	17'7"	15'8"	13'8"	14'9"	14'9"	13'0"	13'10"	13'10"	13'0"	13'0"	13'0"	13'0"	12'5"	12'5"	12'5"	11'10"	11'10"	11'10"	11'5"	11'5"	11'5"	11'0"	11'0"	11'0"	10'7"	10'7"	10'7"	
		10	17'4"	15'8"	13'8"	14'4"	14'4"	13'0"	13'4"	13'4"	13'0"	12'7"	12'7"	12'7"	12'0"	12'0"	12'0"	11'6"	11'6"	11'6"	11'1"	11'1"	11'1"	10'9"	10'9"	10'9"	10'5"	10'5"	10'5"	
	11	8	8'8"	8'8"	8'0"	8'1"	8'1"	7'7"	7'11"	7'11"	7'7"	7'9"	7'9"	7'7"	7'6"	7'6"	7'6"	7'4"	7'4"	7'4"	7'3"	7'3"	7'3"	7'1"	7'1"	7'1"	6'11"	6'11"	6'11"	
		10	10'11"	10'10"	9'6"	10'0"	10'0"	9'0"	9'8"	9'8"	9'0"	9'4"	9'4"	9'0"	9'1"	9'1"	9'0"	8'10"	8'10"	8'10"	8'7"	8'7"	8'7"	8'5"	8'5"	8'5"	8'3"	8'3"	8'3"	
		12	17'1"	15'8"	13'8"	14'1"	14'1"	13'0"	13'2"	13'2"	13'0"	12'6"	12'6"	12'6"	11'11"	11'11"	11'11"	11'5"	11'5"	11'5"	11'1"	11'1"	11'1"	10'8"	10'8"	10'8"	10'5"	10'5"	10'5"	
	13	8	7'4"	7'4"	7'2"	7'0"	7'0"	6'9"	6'10"	6'10"	6'9"	6'8"	6'8"	6'8"	6'7"	6'7"	6'7"	6'5"	6'5"	6'5"	6'4"	6'4"	6'4"	6'2"	6'2"	6'2"	6'1"	6'1"	6'1"	
		10	8'8"	8'8"	8'0"	8'1"	8'1"	7'7"	7'11"	7'11"	7'7"	7'9"	7'9"	7'7"	7'6"	7'6"	7'6"	7'4"	7'4"	7'4"	7'3"	7'3"	7'3"	7'1"	7'1"	7'1"	6'11"	6'11"	6'11"	
		12	10'11"	10'10"	9'6"	10'0"	10'0"	9'0"	9'8"	9'8"	9'0"	9'4"	9'4"	9'0"	9'1"	9'1"	9'0"	8'10"	8'10"	8'10"	8'7"	8'7"	8'7"	8'5"	8'5"	8'5"	8'3"	8'3"	8'3"	
	15	8	7'4"	7'4"	7'2"	7'0"	7'0"	6'9"	6'10"	6'10"	6'9"	6'8"	6'8"	6'8"	6'7"	6'7"	6'7"	6'5"	6'5"	6'5"	6'4"	6'4"	6'4"	6'2"	6'2"	6'2"	6'1"	6'1"	6'1"	
		10	8'8"	8'8"	8'0"	8'1"	8'1"	7'7"	7'11"	7'11"	7'7"	7'9"	7'9"	7'7"	7'6"	7'6"	7'6"	7'4"	7'4"	7'4"	7'3"	7'3"	7'3"	7'1"	7'1"	7'1"	6'11"	6'11"	6'11"	
		12	10'11"	10'10"	9'6"	10'0"	10'0"	9'0"	9'8"	9'8"	9'0"	9'4"	9'4"	9'0"	9'1"	9'1"	9'0"	8'10"	8'10"	8'10"	8'7"	8'7"	8'7"	8'5"	8'5"	8'5"	8'3"	8'3"	8'3"	
800JAM250-68, 50ksi	9	6	13'4"	11'8"	10'2"	12'3"	11'6"	9'8"	11'10"	11'6"	9'8"	11'5"	11'5"	9'8"	11'0"	11'0"	9'8"	10'9"	10'9"	9'8"	10'5"	10'5"	9'8"	10'2"	10'2"	9'8"	9'11"	9'11"	8'8"	
		8	21'1"	16'10"	14'9"	17'3"	16'7"	14'0"	16'0"	14'0"	15'4"	15'4"	14'0"	14'7"	14'7"	14'0"	13'11"	13'11"	13'10"	13'4"	13'4"	13'3"	12'10"	12'10"	12'10"	12'4"	12'4"	12'4"		
		10	13'3"	11'8"	10'2"	12'0"	11'6"	9'8"	11'7"	11'6"	9'8"	11'2"	11'2"	9'8"	10'9"	10'9"	9'8"	10'5"	10'5"	9'8"	10'2"	10'2"	9'8"	9'11"	9'11"	9'8"	9'8"	9'8"	9'8"	
	11	8	10'5"	9'10"	8'7"	9'9"	9'8"	8'2"	9'5"	9'5"	8'2"	9'2"	9'2"	8'2"	8'11"	8'11"	8'2"	8'9"	8'9"	8'2"	8'6"	8'6"	8'2"	8'4"	8'4"	8'2"	8'2"	8'2"	8'2"	
		10	13'2"	11'8"	10'2"	11'11"	11'6"	9'8"	11'5"	11'5"	9'8"	11'0"	11'0"	9'8"	10'8"	10'8"	9'8"	10'4"	10'4"	9'8"	10'1"	10'1"	9'8"	9'10"	9'10"	9'8"	9'7"	9'7"	9'7"	
		12	20'5"	16'10"	14'9"	16'5"	16'5"	14'0"	15'3"	15'3"	14'0"	14'4"	14'4"	14'0"	13'8"	13'8"	13'8"	13'1"	13'1"	13'1"	12'7"	12'7"	12'7"	12'2"	12'2"	12'2"	11'10"	11'10"	11'10"	
	13	8	8'10"	8'9"	7'8"	8'4"	8'4"	7'3"	8'2"	8'2"	7'3"	8'0"	8'0"	7'3"	7'10"	7'10"	7'3"	7'8"	7'8"	7'3"	7'6"	7'6"	7'3"	7'4"	7'4"	7'3"	7'2"	7'2"	7'2"	
		10	10'5"	9'10"	8'7"	9'8"	9'8"	8'2"	9'5"	9'5"	8'2"	9'2"	9'2"	8'2"	8'11"	8'11"	8'2"	8'8"	8'8"	8'2"	8'6"	8'6"	8'2"	8'4"	8'4"	8'2"	8'2"	8'2"	8'2"	
		12	13'1"	11'8"	10'2"	11'10"	11'6"	9'8"	11'5"	11'5"	9'8"	11'0"	11'0"	9'8"	10'8"	10'8"	9'8"	10'4"	10'4"	9'8"	10'1"	10'1"	9'8"	9'10"	9'10"	9'8"	9'7"	9'7"	9'7"	
	15	8	16'5"	13'0"	11'4"	14'8"	12'10"	10'10"	14'8"	12'10"	10'10"	14'8"	12'10"	10'10"	14'5"	12'10"	10'10"	14'0"	12'10"	10'10"	13'7"	12'10"	10'10"	13'2"	12'10"	10'10"	12'10"	12'10"	10'10"	
		10	23'8"	18'10"	16'5"	21'2"	18'6"	15'7"	21'2"	18'6"	15'7"	19'10"	18'6"	15'7"	18'8"	18'6"	15'7"	17'9"	17'7"	15'4"	16'11"	16'10"	14'9"	16'2"	16'2"	14'2"	15'11"	15'11"	13'9"	
		12	16'5"	13'0"	11'4"	14'8"	12'10"	10'10"	14'8"	12'10"	10'10"	14'7"	12'10"	10'10"	14'1"	12'10"	10'10"	13'7"	12'10"	10'10"	13'2"	12'10"	10'10"	13'2"	12'10"	10'10"	12'10"	12'10"	10'10"	
13	8	13'9"	11'0"	9'7"	12'4"	10'10"	9'1"	12'4"	10'10"	9'1"	12'0"	10'10"	9'1"	11'8"	10'10"	9'1"	11'4"	10'10"	9'1"	11'1"	10'10"	9'1"	11'1"	10'10"	9'1"	10'10"				

Refer to Important Table Notes on Page 33

Section	Wall Ht. (ft)	Opening Height (ft)	WIND PRESSURE (PSF) AND DEFLECTION LIMITS																											
			5 psf			15 psf			20 psf			25 psf			30 psf			35 psf			40 psf			45 psf			50 psf			
			L/120	L/240	L/360	L/240	L/360	L/600	L/240	L/360	L/600	L/240	L/360	L/600	L/240	L/360	L/600	L/240	L/360	L/600	L/240	L/360	L/600	L/240	L/360	L/600	L/240	L/360	L/600	
800JAM350-68, 50ksi	9	6	16'11"f	15'4"d	13'4"d	14'10"f	14'10"f	12'8"d	14'1"f	14'1"f	12'8"d	13'5"f	13'5"f	12'8"d	12'10"f	12'10"f	12'8"d	12'3"f	12'3"f	12'3"f	11'11"f	11'11"f	11'11"f	11'8"f	11'8"f	11'8"f	11'3"f	11'3"f	11'3"f	
		8	25'9"f	22'1"d	19'4"d	19'10"f	19'10"f	18'4"d	18'1"f	18'1"f	17'2"d	16'8"f	16'8"f	15'11"d	15'11"f	15'11"f	15'5"d	15'2"f	15'2"f	14'9"d	14'6"f	14'6"f	14'2"d	13'10"f	13'10"f	13'7"d	13'4"f	13'4"f	13'2"d	
	11	8	16'7"f	15'4"d	13'4"d	14'6"f	14'6"f	12'8"d	13'9"f	13'9"f	12'8"d	13'1"f	13'1"f	12'8"d	12'6"f	12'6"f	12'6"f	12'0"f	12'0"f	12'0"f	11'7"f	11'7"f	11'7"f	11'2"f	11'2"f	11'2"f	10'10"f	10'10"f	10'10"f	
		10	24'9"f	22'1"d	19'4"d	19'1"f	19'1"f	18'4"d	17'6"f	17'6"f	16'9"d	16'3"f	16'3"f	15'8"d	15'3"f	15'3"f	14'10"d	14'5"f	14'5"f	14'2"d	13'9"f	13'9"f	13'7"d	13'3"f	13'3"f	13'2"d	12'9"f	12'9"f	12'9"f	
	13	8	13'3"f	12'11"d	11'3"d	11'11"f	11'11"f	10'8"d	11'5"f	11'5"f	10'8"d	10'11"f	10'11"f	10'8"d	10'7"f	10'7"f	10'7"f	10'2"f	10'2"f	10'2"f	9'11"f	9'11"f	9'11"f	9'7"f	9'7"f	9'7"f	9'4"f	9'4"f	9'4"f	
		10	16'6"f	15'4"d	13'4"d	14'2"f	14'2"f	12'8"d	13'5"f	13'5"f	12'8"d	12'9"f	12'9"f	12'8"d	12'2"f	12'2"f	12'2"f	11'9"f	11'9"f	11'9"f	11'4"f	11'4"f	11'4"f	11'0"f	11'0"f	11'0"f	10'8"f	10'8"f	10'8"f	
	15	8	11'4"f	11'4"f	10'1"d	10'4"f	10'4"f	9'7"d	10'0"f	10'0"f	9'7"d	9'7"f	9'7"f	9'7"f	9'4"f	9'4"f	9'4"f	9'0"f	9'0"f	9'0"f	8'10"f	8'10"f	8'10"f	8'7"f	8'7"f	8'7"f	8'4"f	8'4"f	8'4"f	
		10	13'2"f	12'11"d	11'3"d	11'10"f	11'10"f	10'8"d	11'3"f	11'3"f	10'8"d	10'10"f	10'10"f	10'8"d	10'5"f	10'5"f	10'5"f	10'1"f	10'1"f	10'1"f	9'10"f	9'10"f	9'10"f	9'7"f	9'7"f	9'7"f	9'4"f	9'4"f	9'4"f	
	800JAM350-97, 50ksi	9	6	21'7"d	17'2"d	15'0"d	19'4"d	16'10"d	14'2"d	18'5"f	16'10"d	14'2"d	17'6"f	16'10"d	14'2"d	16'8"f	16'8"f	14'2"d	16'0"f	16'0"f	14'2"d	15'5"f	15'5"f	14'2"d	14'10"f	14'10"f	14'2"d	14'4"f	14'4"f	14'1"d
			8	31'2"d	24'9"d	21'7"d	25'9"f	24'4"d	20'6"d	23'5"f	22'9"d	19'2"d	21'7"f	21'1"d	17'10"d	20'2"f	19'10"d	16'9"d	19'0"f	18'10"d	15'11"d	18'0"f	18'0"f	15'8"d	17'2"f	17'2"f	15'2"d	16'5"f	16'5"f	14'8"d
		11	8	21'7"d	17'2"d	15'0"d	18'9"f	16'10"d	14'2"d	17'7"f	16'10"d	14'2"d	16'7"f	16'7"f	14'2"d	15'11"f	15'11"f	14'2"d	15'5"f	15'5"f	14'2"d	14'10"f	14'10"f	14'2"d	14'3"f	14'3"f	14'1"d	13'10"f	13'10"f	13'8"d
			10	31'2"d	24'9"d	21'7"d	24'1"f	23'5"d	19'11"d	21'9"f	21'3"d	18'7"d	20'0"f	19'11"d	17'4"d	19'3"f	19'3"f	16'5"d	18'2"f	18'2"f	15'8"d	17'4"f	17'4"f	15'0"d	16'6"f	16'6"f	14'6"d	15'11"f	15'11"f	14'1"d
13		8	17'5"f	14'5"d	12'7"d	15'7"f	14'2"d	12'0"d	14'10"f	14'2"d	12'0"d	14'2"f	14'2"f	12'0"d	13'8"f	13'8"f	12'0"d	13'2"f	13'2"f	12'0"d	12'8"f	12'8"f	12'0"d	12'4"f	12'4"f	12'0"d	12'0"f	12'0"f	12'0"f	
		10	21'7"f	17'2"d	15'0"d	18'4"f	16'10"d	14'2"d	17'3"f	16'10"d	14'2"d	16'4"f	16'4"f	14'2"d	15'6"f	15'6"f	14'2"d	14'10"f	14'10"f	14'2"d	14'4"f	14'4"f	14'2"d	13'10"f	13'10"f	13'8"d	13'4"f	13'4"f	13'3"d	
15		8	15'0"f	12'11"d	11'3"d	13'7"f	12'8"d	10'8"d	13'0"f	12'8"d	10'8"d	12'6"f	12'6"f	10'8"d	12'1"f	12'1"f	10'8"d	11'8"f	11'8"f	10'8"d	11'4"f	11'4"f	10'8"d	11'0"f	11'0"f	10'8"d	10'8"f	10'8"f	10'8"f	
		10	17'4"f	14'5"d	12'7"d	15'4"f	14'2"d	12'0"d	14'7"f	14'2"d	12'0"d	13'11"f	13'11"f	12'0"d	13'4"f	13'4"f	12'0"d	12'11"f	12'11"f	12'0"d	12'5"f	12'5"f	12'0"d	12'1"f	12'1"f	12'0"d	11'9"f	11'9"f	11'9"f	
800JAM350-118, 50ksi		9	6	22'11"d	18'3"d	15'11"d	20'6"d	17'11"d	15'1"d	20'6"d	17'11"d	15'1"d	20'1"f	17'11"d	15'1"d	19'2"f	17'11"d	15'1"d	18'4"f	17'11"d	15'1"d	17'8"f	17'8"f	15'1"d	17'0"f	17'0"f	15'1"d	16'5"f	16'5"f	15'0"d
			8	33'2"d	26'3"d	22'11"d	29'6"f	25'10"d	21'10"d	26'10"f	24'2"d	20'5"d	24'9"f	22'6"d	18'11"d	23'1"f	21'2"d	17'10"d	21'9"f	20'1"d	16'11"d	20'7"f	19'2"d	16'2"d	19'8"f	18'6"d	15'11"d	18'9"f	17'10"d	15'6"d
		11	8	22'11"d	18'3"d	15'11"d	20'6"d	17'11"d	15'1"d	20'2"f	17'11"d	15'1"d	19'1"f	17'11"d	15'1"d	18'1"f	17'11"d	15'1"d	17'4"f	17'4"f	15'1"d	16'7"f	16'7"f	15'1"d	15'11"f	15'11"f	15'0"d	15'9"f	15'9"f	14'6"d
			10	33'2"d	26'3"d	22'11"d	27'8"f	24'11"d	21'0"d	25'0"f	22'8"d	19'8"d	22'11"f	21'0"d	18'5"d	21'4"f	19'11"d	17'4"d	20'1"f	19'5"d	16'7"d	19'7"f	18'7"d	15'11"d	18'9"f	17'11"d	15'4"d	18'0"f	17'4"d	14'10"d
	13	8	19'4"d	15'4"d	13'5"d	17'4"d	15'1"d	12'9"d	16'10"f	15'1"d	12'9"d	16'1"f	15'1"d	12'9"d	15'7"f	15'1"d	12'9"d	15'0"f	15'0"f	12'9"d	14'6"f	14'6"f	12'9"d	14'1"f	14'1"f	12'9"d	13'8"f	13'8"f	12'9"d	
		10	22'11"d	18'3"d	15'11"d	20'6"d	17'11"d	15'1"d	19'8"f	17'11"d	15'1"d	18'7"f	17'11"d	15'1"d	17'8"f	17'8"f	15'1"d	16'11"f	16'11"f	15'1"d	16'3"f	16'3"f	15'0"d	15'8"f	15'8"f	14'6"d	15'1"f	15'1"f	14'0"d	
	15	8	17'2"f	13'9"d	12'0"d	15'5"d	13'6"d	11'5"d	14'10"f	13'6"d	11'5"d	14'4"f	13'6"d	11'5"d	13'9"f	13'6"d	11'5"d	13'4"f	13'4"f	11'5"d	12'11"f	12'11"f	11'5"d	12'6"f	12'6"f	11'5"d	12'2"f	12'2"f	11'5"d	
		10	19'4"d	15'4"d	13'5"d	17'4"d	15'1"d	12'9"d	16'8"f	15'1"d	12'9"d	15'10"f	15'1"d	12'9"d	15'3"f	15'1"d	12'9"d	14'8"f	14'8"f	12'9"d	14'2"f	14'2"f	12'9"d	13'8"f	13'8"f	12'9"d	13'4"f	13'4"f	12'9"d	
	17	8	22'11"d	18'3"d	15'11"d	20'6"f	17'11"d	15'1"d	19'2"f	17'11"d	15'1"d	18'1"f	17'11"d	15'1"d	17'2"f	17'2"f	15'1"d	16'5"f	16'5"f	15'1"d	15'10"f	15'10"f	14'8"d	15'3"f	15'3"f	14'2"d	14'9"f	14'9"f	13'9"d	

## Project Example

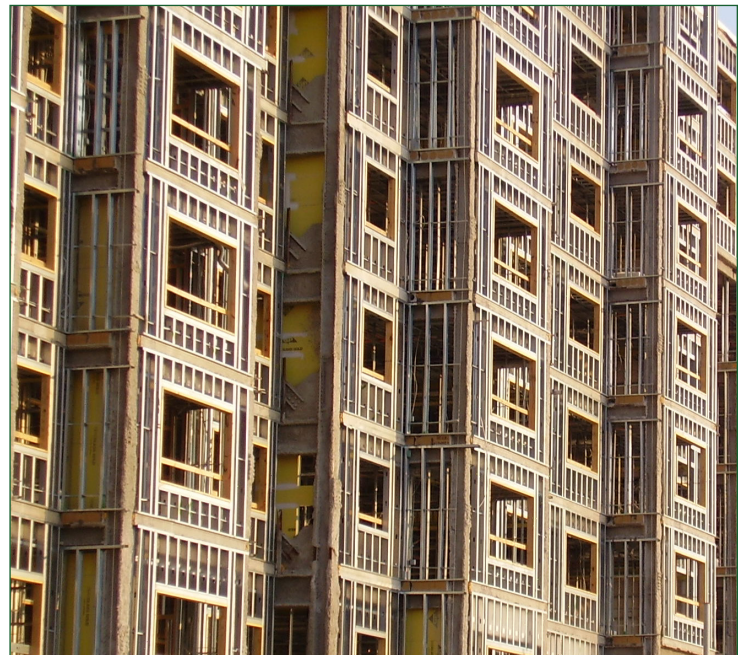

Use of JamStud® as jambs and openings on this 8 story project saved the contractor significant time and labor expenses. With the high amount of openings (500+) it is easy to see how JamStud positively benefits installation. Use of JamStud in lieu of built-up jambs and headers cut materials by over 50% and reduced labor associated with the built-up materials.

# Exterior Wall Framing & Accessories

# Header/Sill Solutions

## JamStud® Header/Sill Assembly Value

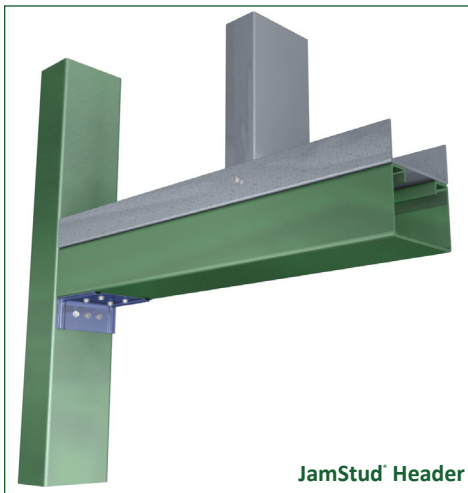

JamStud delivers exceptional value when utilized as part of a header or sill assembly. JamStud's unique shape allows for the design and construction of a lightweight header versus the more cumbersome built-up header assemblies. Oriented horizontally, JamStud provides an increased stiffness and strength compared with standard 'cee' studs, resulting in lighter headers which require less labor to install.

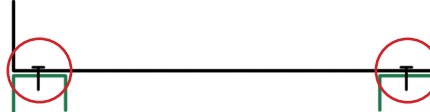

The d1 dimension of the JamStud does accommodate a single #10 or #12 screw (d=0.19" or 0.216"). Proper installation is desired to center the screw within the flat width of dimension d1.



### JamStud® Header

- Reduces overall materials used
- Speeds installation
- Fewer fasteners
- Simple Inspection

### Typical "Boxed" Header Assemblies

**One Stud "Box" Header**      **Two Stud "Box" Header**

\* The top track seen in the assemblies above is to capture the cripple studs above and does not factor in the design of the header.

## Load Transfer to Jamb



The Steel Network's StiffClip® AL series represents an ideal method to transfer loads from the header or sill to the jamb. Stiffened ribs add strength, and guide holes are provided for quick and accurate fastener placement. StiffClip AL is available in 3 5/8", 6" and 8" depths. For allowable load data, see TSN's *Light Steel Framing Connections Catalog*, or visit [www.steelnetwork.com](http://www.steelnetwork.com).

## High-Wind-Load Headers

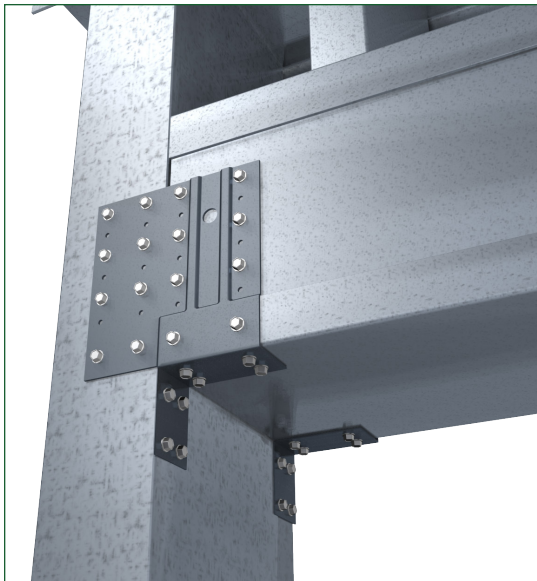

In high wind and axial load bearing wall applications, JamStud may be placed inside of a deep-leg track to provide a strong labor-efficient alternative to four-piece "Box" headers. While the amount of fasteners remains consistent, use of JamStud reduces material handling by half to streamline the installation process. Load is effectively transferred to the jambs via TSN's StiffClip HE connectors. With the use of box headers, jack studs are also typically used to support the header vertically. The shelf leg of the StiffClip HE supports the header vertically to eliminate the use of a jack stud. In addition, the StiffClip HE provides web crippling resistance for the header.

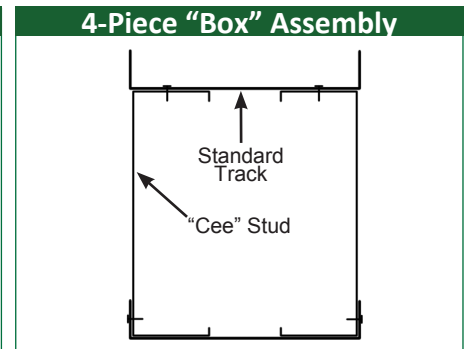
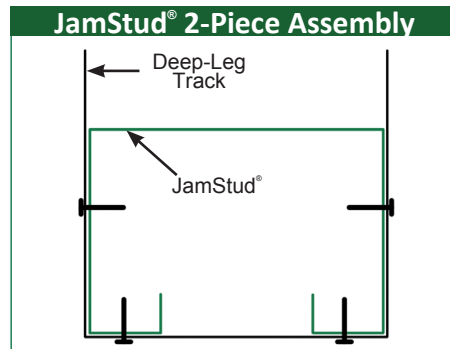

# Exterior Wall Framing & Accessories ThermaFast® Continuous Rigid Insulation Framing System

## Introduction

Recent changes in the IECC Energy Conservation Code and ASHRAE Standard 90.1 necessitate the installation of 1 to 4 inches of continuous rigid insulation layer on the outside surface of exterior metal stud walls. Existing building component systems lack sufficient accommodation for cladding assemblies, like cement board panels, siding, metal panels, EIFS, stucco, etc. since there is no viable means to attach to a stable substrate like plywood or gypsum sheathing over the thick rigid insulation layer other than long and unstable cantilevered screws.

Over time, and lacking a product that addressed this need, Architects have either reduced or abandoned altogether the use of such cladding in their designs, waiting for the steel framing industry to provide a solution.

TSN's ThermaFast® Rigid Insulation Framing system is "The" solution. ThermaFast is an engineered installer-friendly set of steel framing tracks and angles designed to be an integral part of the continuous rigid insulation, and at the same time provide a stable component for direct substrate attachment. ThermaFast parts include preinstalled thermal tape on each piece and slotted webs on the Z-Tracks to minimize thermal conductivity through the rigid insulation layer. Unique rigid insulation engagement to keep foam layers from sliding or popping out of place.

## System Components

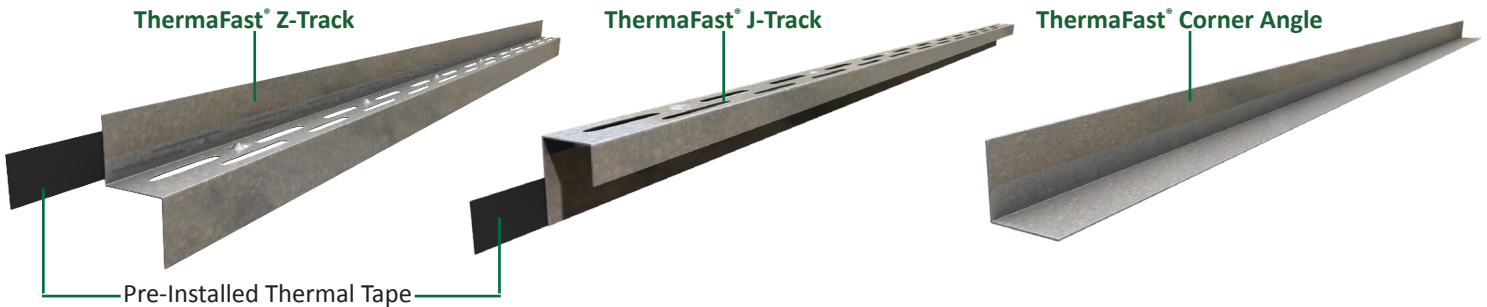

## System Configuration

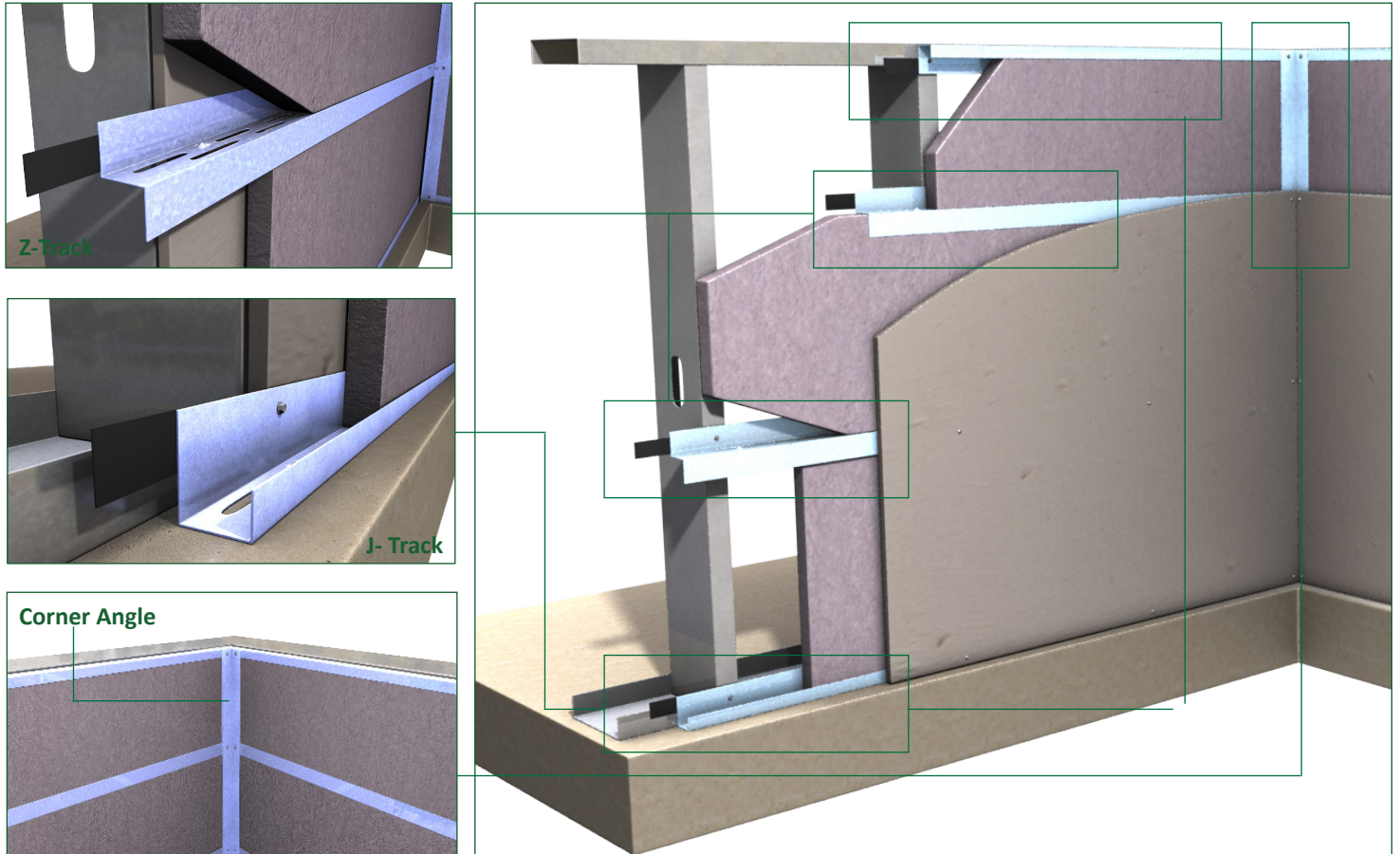

Request TSN catalog of thermal resistances and thermal transmittances of wall assemblies with ThermaFast® Continuous Rigid Insulation Framing System.

# Exterior Wall Framing & Accessories ThermaFast® Continuous Rigid Insulation Framing System

Nomenclature

## 150ZT-54, 50 ksi

Rigid Foam Insulation Depth (in) x 100

Ex: 1.5" = 150

For all "CA" sections, this dimension is the leg length  
ex: 2" leg = 200

Style

Ex: ZT = Z-Track Section

Other designators are as follows:

JT = J-Track

CA = Corner Angle

Material Thickness (mils)

Ex: 0.054" = 54 mils (16ga)

Material Thickness is the minimum base metal thickness in mils, representing 95% of the design thickness.

### Example Details\*

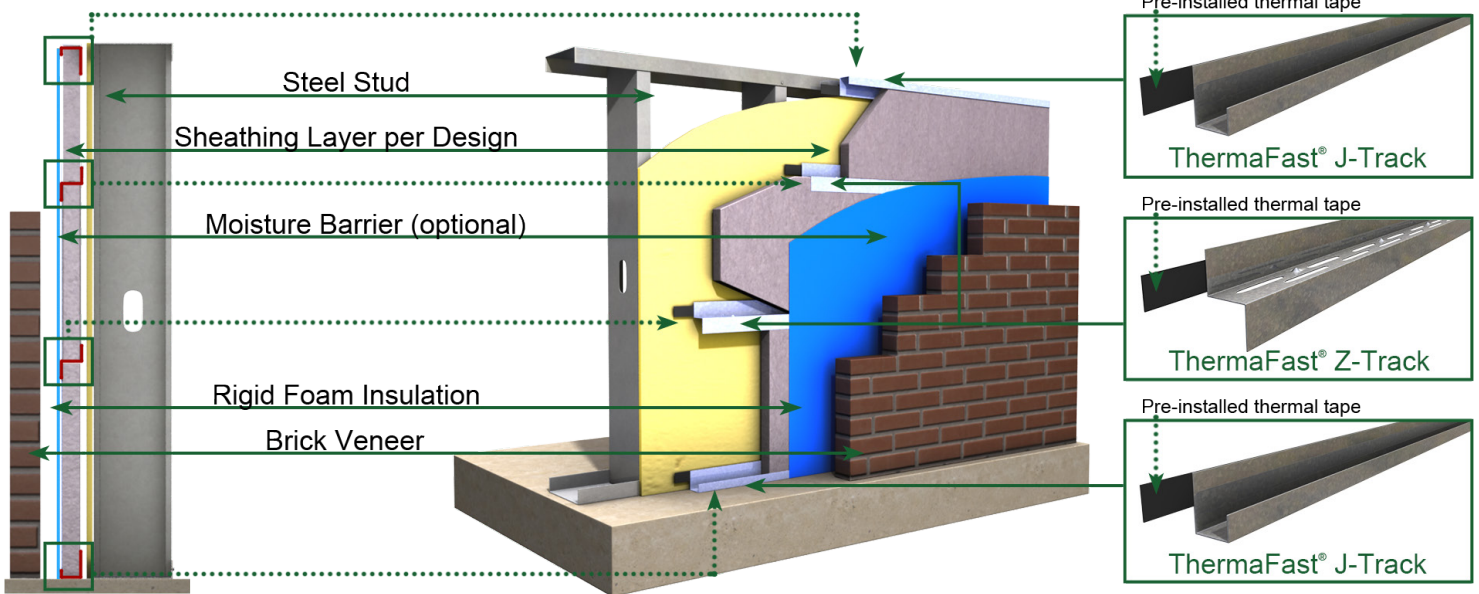

### Example Details - ThermaFast® used with Furring Channel

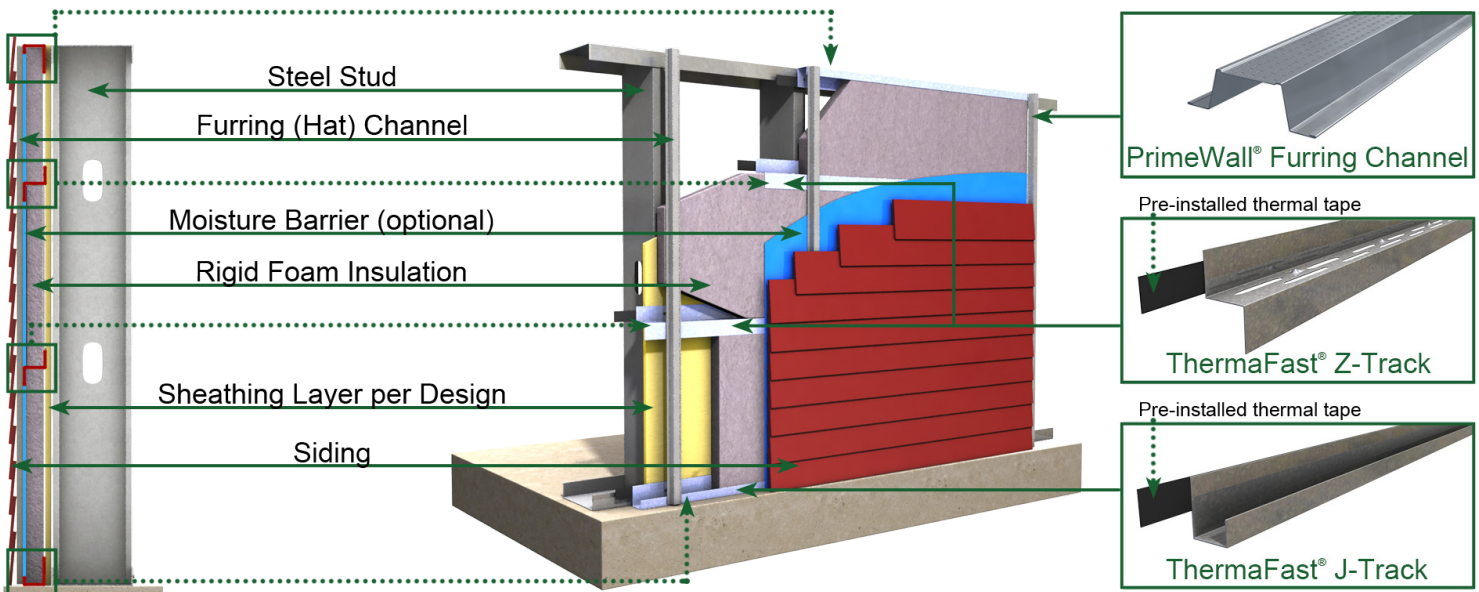

\* Refer to project specification and/or architectural sections for wall assembly details related to fire and acoustical performance as well as water resistance.

# Exterior Wall Framing & Accessories

## Introduction

This catalog provides thermal performance data (R- and U-values) of the ThermaFast® Rigid Insulation Framing System produced by the Steel Network Inc. The ThermaFast System is used in exterior wall assemblies to support rigid foam insulation with thicknesses ranging from 1.0 inch to 4.0 inch. In addition, the ThermaFast System provides viable means to attach the cladding assemblies, like cement board, siding, metal panels, to a stable substrate instead of using long and unstable cantilevered screws to the sheathing layer. This summary allows designers to have fast and straightforward access to information with sufficient accuracy to reduce uncertainty in the thermal performance of building envelope components.

Thermal modelling for this project was completed using a 3D finite element analysis heat transfer software package by SolidWorks®; SW Thermal Solver and follows ASHRAE/IES Standard 90.1 requirements.

# Thermal Resistances & Thermal Transmittances of Wall Assemblies

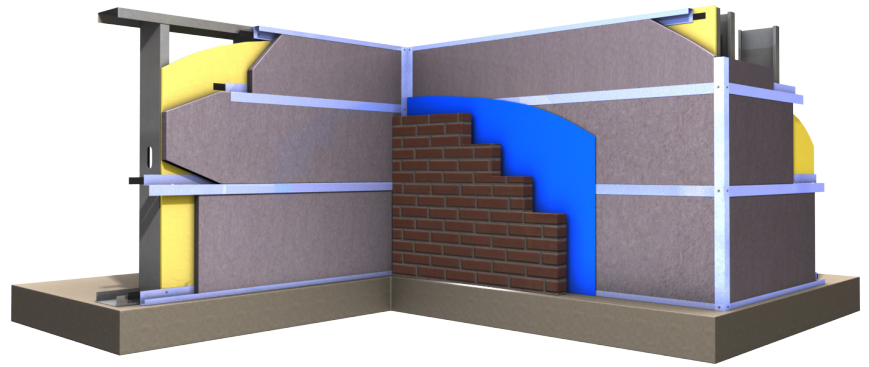

Assembly # <sup>1</sup>	Steel Stud Size	Exterior Rigid Insulation Thickness	Stud Cavity Insulation (min.)	ThermaFast® Z-Track Size	Nominal Resistance R <sub>0</sub>	Transmittance U <sub>0</sub>
					m <sup>2</sup> ·K/W (hr·ft <sup>2</sup> ·°F/Btu)	W/m <sup>2</sup> ·K (Btu/ft <sup>2</sup> ·hr·°F)
<b>6" Steel Stud Walls</b>						
1 <sup>2</sup>	600S162-43	2"	None	200ZT-54	1.88 (R-10.67)	0.532 (0.093)
2	600S162-43	1.5"	R-19 Batt	150ZT-54	3.12 (R-17.71)	0.321 (0.056)
3	600S162-43	2"	R-19 Batt	200ZT-54	3.50 (R-19.89)	0.285 (0.050)
4	600S162-43	2"	1 ½" Spray Foam	200ZT-54	2.94 (R-16.7)	0.340 (0.060)
5	600S162-43	2"	3" Spray Foam	200ZT-54	3.50 (R-19.89)	0.286 (0.050)
6	600S162-43	3"	R-19 Batt	300ZT-54	4.04 (R-22.97)	0.248 (0.044)
7	600S162-43	4"	R-19 Batt	400ZT-54	4.50 (R-25.55)	0.222 (0.039)
<b>8" Steel Stud Walls</b>						
8	800S162-43	2"	R-25 Batt	200ZT-54	3.91 (R-22.18)	0.258 (0.045)
9	800S162-43	3"	R-25 Batt	300ZT-54	4.44 (R-25.2)	0.225 (0.040)
10	800S162-43	4"	R-25 Batt	400ZT-54	4.89 (R-27.75)	0.205 (0.036)

### Table Notes:

<sup>1</sup> Details of input and output data for each assembly are provided in Section 5 of the full report "Thermal Analysis of ThermaFast® Rigid Insulation Framing System" by the Steel Network, Inc.

<sup>2</sup> Assembly 1 is only presented as a reference for other assemblies.

# Exterior Wall Framing & Accessories ThermaFast® Corner Angle Product Profile

## 200CA-54, 50 ksi

Leg Length

CA

ThermaFast® Corner Angle

Material Thickness

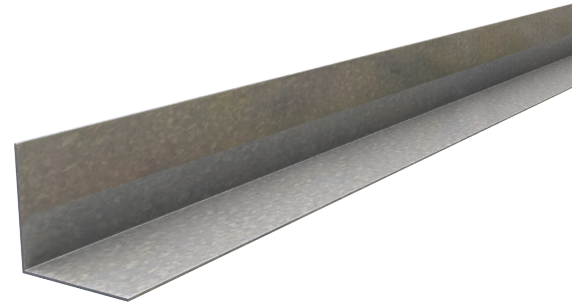
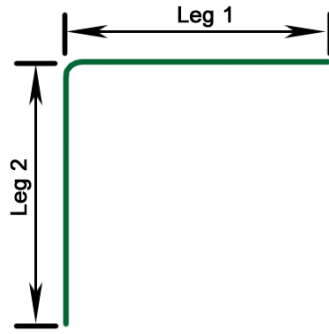

### Material Properties

ASTM A1003/A1003M Structural Grade 50 (340) Type H, ST50H (ST340H): 50ksi (340MPa) minimum yield strength, 65ksi(450MPa) minimum tensile strength, with ASTM A653/A653M G90 (Z275) hot dipped galvanized coating. Available in 33mil minimum thickness (20 gauge, 0.0346" design thickness) or 54mil minimum thickness (16 gauge, 0.0566" design thickness).

ThermaFast® Corner Angle Product Profile						
Section	Leg Length	Gauge	Design Thickness	Min Steel Thickness	Inside Bend Radius	Unit Weight
	(in)	(ga)	(in)	(in)	(R)	(lbs/ft)
200CA-33, 50ksi	2.0	20	0.0346	0.0329	0.0625	0.46
200CA-54, 50ksi	2.0	16	0.0566	0.0538	0.0625	0.75

- Refer to project specification and/or architectural sections for wall assembly details related to fire and acoustical performance as well as water resistance.

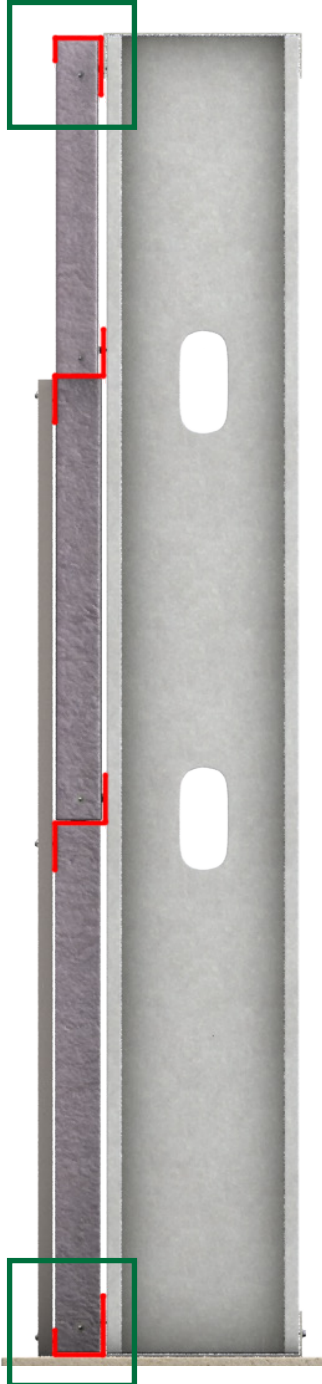
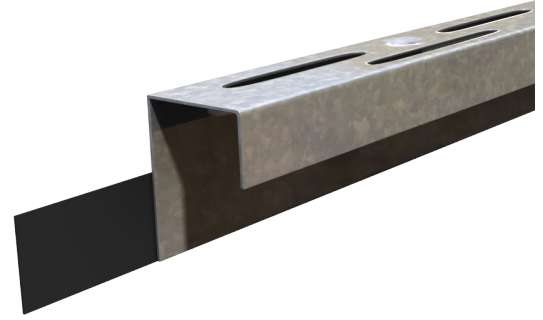
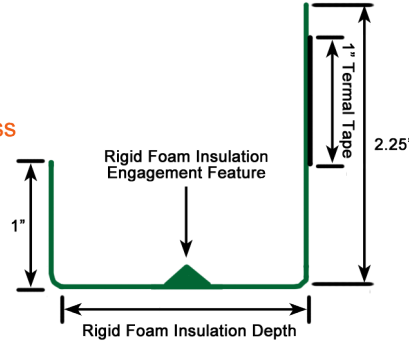
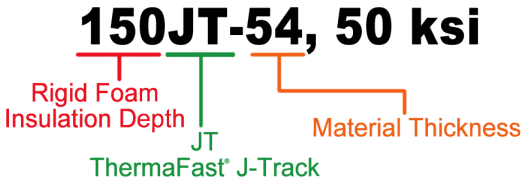

**Material Properties**

**Metal:** ASTM A1003/A1003M Structural Grade 50 (340) Type H, ST50H (ST340H): 50ksi (340MPa) minimum yield strength, 65ksi(450MPa) minimum tensile strength, with ASTM A653/A653M G90 (Z275) hot dipped galvanized coating. Available in 33mil minimum thickness (20 gauge, 0.0346" design thickness) or 54mil minimum thickness (16 gauge, 0.0566" design thickness).

**Thermal Tape:** Thickness 1/16", Density 25 lbs/ft<sup>3</sup> (ASTM D3574), Thermal Conductivity k-factor 0.3 Btu-in/hour-ft<sup>2</sup>-°F (ASTM C518)

ThermaFast® J-Track Product Profile								
Section	Leg Length	Rigid Foam Insulation Depth	Return Lip	Gauge	Design Thickness	Min Steel Thickness	Inside Bend Radius	Unit Weight
	(in)	(in)	(in)	(ga)	(in)	(in)	(R)	(lbs/ft)
100JT-33, 50ksi	2.25	1.0	1.0	20	0.0346	0.0329	0.0625	0.49
150JT-33, 50ksi		1.5						0.54
200JT-33, 50ksi		2.0						0.57
300JT-33, 50ksi		3.0						0.69
400JT-33, 50ksi		4.0						0.80
100JT-54, 50ksi	2.25	1.0	1.0	16	0.0566	0.0538	0.0625	0.79
150JT-54, 50ksi		1.5						0.87
200JT-54, 50ksi		2.0						0.92
300JT-54, 50ksi		3.0						1.11
400JT-54, 50ksi		4.0						1.30

ThermaFast® J-Track Section Properties		
Section	M <sub>xa</sub>	M <sub>ya</sub>
	(kips-in)	(kips-in)
100JT-33, 50ksi	0.07	0.10
150JT-33, 50ksi	0.10	0.28
200JT-33, 50ksi	0.10	0.46
300JT-33, 50ksi	0.13	0.84
400JT-33, 50ksi	0.17	1.24
100JT-54, 50ksi	0.26	0.31
150JT-54, 50ksi	0.32	0.80
200JT-54, 50ksi	0.37	1.37
300JT-54, 50ksi	0.45	2.96
400JT-54, 50ksi	0.47	4.66

**Table Notes:**

- M<sub>xa</sub> is the ASD moment capacity in the gravity load direction based on 24" o.c. fastening to stud max.
- M<sub>ya</sub> is the ASD moment capacity in the wind load direction based on 24" o.c. fastening to stud max.
- Attach track with minimum (1) #10-16 self-drilling screws to each stud. (2) screws may be required for high design wind pressures (higher than 30 psf service level)
- Refer to project specification and/or architectural sections for wall assembly details related to fire and acoustical performance as well as water resistance.

ThermaFast J-Track is installed first, at base and head of wall.

**150ZT-54, 50 ksi**

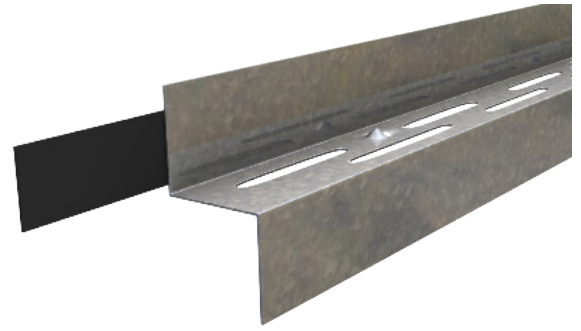
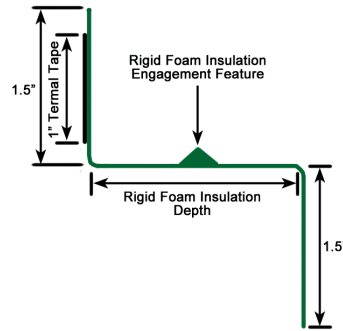

**Material Properties**

ASTM A1003/A1003M Structural Grade 50 (340) Type H, ST50H (ST340H): 50ksi (340MPa) minimum yield strength, 65ksi(450MPa) minimum tensile strength, with ASTM A653/A653M G90 (Z275) hot dipped galvanized coating. Available in 33mil minimum thickness (20 gauge, 0.0346" design thickness) or 54mil minimum thickness (16 gauge, 0.0566" design thickness).

**Thermal Tape:** Thickness 1/16", Density 25 lbs/ft<sup>3</sup> (ASTM D3574), Thermal Conductivity k-factor 0.3 Btu-in/hour-ft<sup>2</sup>-°F (ASTM C518)

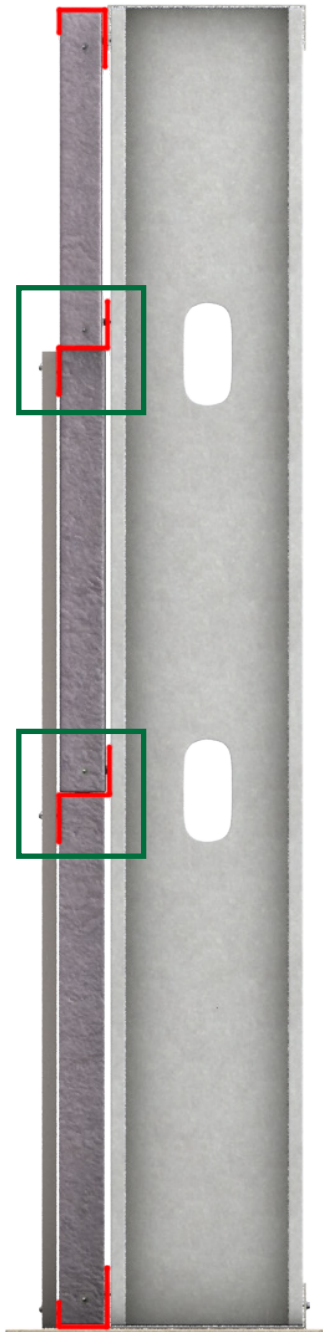

ThermaFast Z-Track is installed between every 24" rigid foam insulation.

ThermaFast® Z-Track Product Profile								
Section	Leg 1 Length (in)	Leg 2 Length (in)	Rigid Foam Insulation Depth (in)	Gauge (ga)	Design Thickness (in)	Min Steel Thickness (in)	Inside Bend Radius (R)	Unit Weight (lbs/ft)
100ZT-33, 50ksi	1.5	1.5	1.0	20	0.0346	0.0329	0.0625	0.47
150ZT-33, 50ksi			1.5					0.50
200ZT-33, 50ksi			2.0					0.53
300ZT-33, 50ksi			3.0					0.65
400ZT-33, 50ksi			4.0					0.76
100ZT-54, 50ksi	1.5	1.5	1.0	16	0.0566	0.0538	0.0625	0.76
150ZT-54, 50ksi			1.5					0.81
200ZT-54, 50ksi			2.0					0.85
300ZT-54, 50ksi			3.0					1.05
400ZT-54, 50ksi			4.0					1.24

ThermaFast® Z-Track Section Properties		
Section	M <sub>xa</sub> (kips-in)	M <sub>ya</sub> (kips-in)
100ZT-33, 50ksi	0.78	0.74
150ZT-33, 50ksi	0.78	1.33
200ZT-33, 50ksi	0.78	1.75
300ZT-33, 50ksi	0.78	2.81
400ZT-33, 50ksi	0.78	3.96
100ZT-54, 50ksi	1.86	1.65
150ZT-54, 50ksi	1.86	3.13
200ZT-54, 50ksi	1.86	4.22
300ZT-54, 50ksi	1.86	6.80
400ZT-54, 50ksi	1.86	9.64

**Table Notes:**

- M<sub>xa</sub> is the ASD moment capacity in the gravity load direction based on 24" o.c. fastening to stud max.
- M<sub>ya</sub> is the ASD moment capacity in the wind load direction based on 24" o.c. fastening to stud max.
- Attach track with minimum one #10-16 self-drilling screws to each stud. (2) screws may be required for high design wind pressures (higher than 30 psf service level)
- Refer to project specification and/or architectural sections for wall assembly details related to fire and acoustical performance as well as water resistance.



# SteelSmart® System 7.8

With 2018 IBC, AISI S100-16 & ASCE 7-16

**The industry's #1 tool for the design of Members, Connections, Fasteners & Details Introduction:**

SteelSmart® System (SSS) provides construction professionals with an essential tool engineered for both fast and accurate design. SSS 7.8 raises the bar for light steel framing analysis and design by seamlessly integrating the well-known analytic power of its predecessors with additional functionality and accessibility.

Available as a complete suite, SteelSmart System 7.8 will streamline production through the design and detailing of members, connections, and fasteners. Available design modules include: Curtain Wall, Load Bearing Wall, X-Brace Shear Wall, Floor Framing, Roof Framing, Roof Truss, and Moment-Resisting Short Wall. SSS 7.8 incorporates two Advanced Features, the Load Generator and Distributor and the Layout and Connection Details Generator, that further aid the user in the design process.

**SteelSmart® System 7.8**  
With 2018 IBC & ASCE 7-16

**COMPONENT DESIGN MODULES**

- Curtain Wall
- Load Bearing Wall
- X-Brace Shear Wall
- Floor Framing
- Roof Framing
- Roof Trusses
- Moment-Resisting Short Wall

**SSS News Feed [Live]**

- What's New with SteelSmart System 7.7
- SteelSmart Framer – Build 116 Released!
- 4 Ways to Save Time and Money Using BIM with

**Advanced Tools**

- CUSM - Calculates elastic buckling loads to use with the Direct Strength Method of the AISI S100-16 Specification

**Recently Opened Files**

- ASCE 7 Load Generator & Distributor
- Section Properties Calculator
- Utilities
- Resources
- Settings

© 2019 APPLIED SCIENCE INTERNATIONAL, LLC. ALL RIGHTS RESERVED. Your License Will Expire in 20 Days. Contact Us | License Agreement

Order online at [www.steelSMARTsystem.com](http://www.steelSMARTsystem.com)

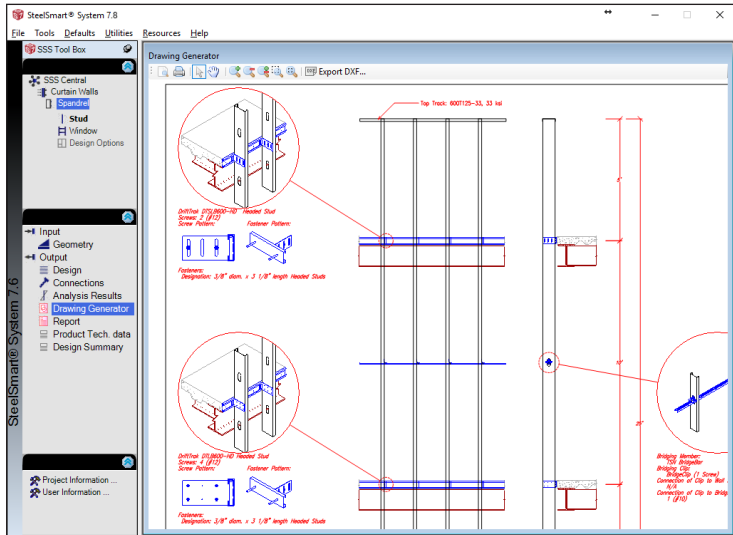

### Layout and Connection Details Generator

A major feature of SSS is the Layout and Connection Details Generator. The framing layout of components is generated with connection details that include connection design data (clips designations, number of fasteners, embedment lengths, and screw patterns). The drawing generator is included within all 7 primary design modules, and will create a detail upon successful design of components. The drawings can be printed or exported in the AutoCAD® DXF format allowing the drawings to be easily transferred into other drafting software.

In addition to the Layout and Connection Details generator, there is also a library of component details within SSS. Details are split into 7 categories including: Curtain Wall, Load Bearing Walls, Shear Walls, Products Details, Floor Framing, and LSF Systems.

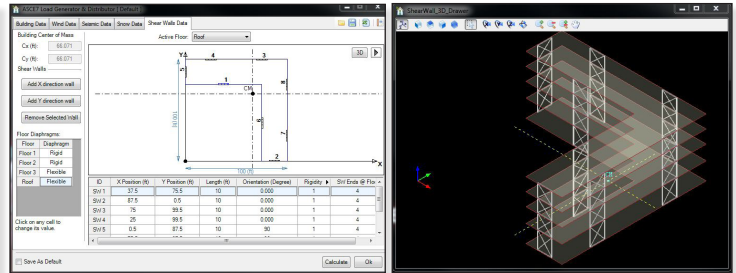

### Load Generator and Distributor

The Load Generator and Distributor tool uses the dimensions and load specification for a building to calculate the lateral wind and seismic forces according to ASCE 7 "Minimum Design Loads for Buildings and Other Structures." Now included in the Load Generator is the IBC 2018 and ASCE 7-16 design codes for development of lateral forces and snow loads. The output from the load generator gives the lateral forces distributed between floor levels and the shear walls at that floor level. The method of distribution considers either rigid or flexible floor diaphragms, while considering torsional effects when rigid diaphragms are selected. Output can be exported directly into the X-Brace Shear Wall design module or into an Excel spreadsheet.

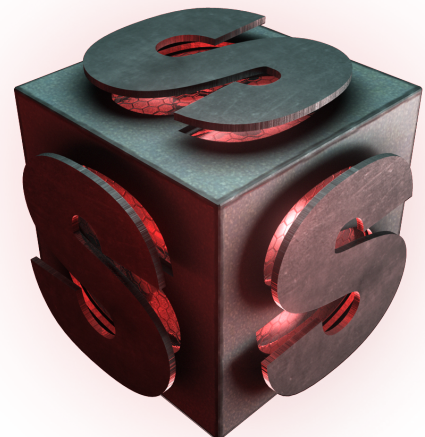

**Contact ASI for licensing information:**  
 Phone: (919) 645-4090  
 Fax: (919) 645-4085  
 Website: [www.appliedscienceint.com](http://www.appliedscienceint.com)  
 Email: [support@appliedscienceint.com](mailto:support@appliedscienceint.com)

## Product Use

Products in this catalog are designed and manufactured for the specific purposes shown, and should not be used in other applications unless approved by a qualified design professional. All modifications to products or changes in installation procedures should be made by a qualified design professional. The performance of such modified products or altered installation procedures is the sole responsibility of the design professional or installation contractor. The installation contractor and/or qualified design professional are responsible for installing all products in accordance with relevant specifications and building codes.

Customers modifying products or installation procedures, or designing non-standard products for fabrication by The Steel Network, Inc. ("TSN") shall, regardless of specific instructions to the user, indemnify, defend, and hold TSN harmless for any and all claimed loss or damage occasioned in whole or in part by non-standard or modified products or installation procedures.

Loads published on TSN's website and current product catalogs are for the described specific applications of properly installed products. Modifications to TSN products, improper loading or installation procedures, or deviations from recommended applications will affect TSN products' load-carrying capacities. TSN products are fabricated from hot-dipped galvanized steel for corrosion protection but will corrode and lose load-carrying capacity if exposed to salt air, corrosive fire-retardant chemicals, fertilizers, or other substances that may adversely affect steel or its galvanized coating. The current editions of TSN's catalogs and load tables published on this website may reflect changes in the allowable loads and configurations of some of TSN's products. This information supersedes information in earlier catalogs or technical reports. All earlier catalogs or technical reports should be discarded and reference made exclusively to the versions available at <http://www.steelnetwork.com/Site/Catalogs>. TSN may correct any clerical or typographical errors. All sales are subject to TSN's standard terms and conditions of sale.

## Limited Warranty

TSN warrants its products to be free from defects in material or workmanship at the time of shipment. TSN standard catalog products are warranted for adequacy of design when used in accordance with design limits in this document and properly specified and installed. TSN products shall not be substituted with non-TSN products if it is part of a system. Substitution of a TSN product will immediately void any warranty claim made by Purchaser. This warranty excludes uses not in compliance with specific applications and installation procedures set forth in this document. Warranty claims must be made by Purchaser in writing within ninety (90) days of receipt of the products.

All warranty obligations of TSN shall be limited, at the sole discretion of TSN, to repair or replace the defective product(s). These remedies shall constitute TSN's sole obligation and sole remedy of purchaser under this warranty. In no event will TSN be responsible for incidental, consequential, indirect, exemplary, incidental, special, consequential, or punitive damages, or other losses or damages however caused, including, but not limited to, installation costs, lost revenue or lost profits. TSN's liability for damages shall in no event exceed the applicable portion of the purchase price for defective product(s).

Product defects that arise from acts of God, accidents, misuse, misapplication, improper installation, storage damage, negligence, or modification to product(s) or its components are specifically excluded from this warranty. Product defects that arise from Purchaser providing incorrect information to TSN, including but not limited to incorrect specifications such as incorrect dimensions, designs and/or loads, are also specifically excluded from this warranty. TSN does not authorize any person or party to assume or create for it any other obligation or liability in connection with Products except as set forth herein.

This Warranty is expressly in lieu of all other warranties, expressed or implied, including any warranties of merchantability or fitness for a particular purpose, all such other warranties being hereby expressly excluded.

## Patented Technology

BackIt®, BridgeBar®, BridgeClip®, BuckleBridge®, CircleTrak®, DriftClip®, DriftCorner®, DriftTrak®, GripClip®, 600JAM®, 800JAM®, JamStud®, MidWall™, MasterClip®, NotchTrak®, PrimeWall®, 600SG®, 800SG®, SigmaStud®, SigmaTrak®, Step-Bushing Technology™, StiffClip®, StiffWall®, ThermaFast®, TightStrap®, VertiClip®, and VertiTrack® are trademarked products, and are patented or patent-pending technologies of TSN. Numerous TSN design configurations are patented and/or patent pending and are protected under US and International patent laws. Patent numbers include: #4,970,410; #4,970,411; #4,970,412; #4,970,413; #5,079,710; #5,467,566; #5,904,023; #5,906,080; #6,612,087; #6,701,689; #6,892,504; #7,104,024; #7,503,150; #7,559,519; #7,596,921; #7,634,889; #7,788,878; #7,832,162; #7,836,657; #8,132,383; #8,181,419; #8,205,402; #8,387,321 and #8,683,770.

## Contact Information

### North Carolina

**TSN Corporate Headquarters**  
2012 TW Alexander Drive  
P.O. Box 13997  
Durham, NC 27709  
**Phone:** (919) 845-1025  
**Fax:** (888) 474-4877

### Texas

600 Lemens Avenue  
Suite 120  
Hutto, TX 78634  
**Phone:** (512) 642-9603  
**Fax:** (512) 857-1663

### Nevada

1650 Helm Drive  
Suite 1000 -1200  
Las Vegas, NV 89119  
**Phone:** (702) 643-4330  
**Fax:** (702) 643-4331

**Web Site:** [www.steelnetwork.com](http://www.steelnetwork.com)  
**E-mail:** [support@steelnetwork.com](mailto:support@steelnetwork.com)

**Toll Free Nationwide Phone**  
**(888) 474-4876**



