

# SpecSeal® Quick Clip™ Perimeter Fire Barrier System

The SpecSeal® Quick Clip™ Perimeter Fire Barrier System is designed to accelerate the installation of curtain wall insulation for perimeter fire barrier systems. The system's unique U-Brackets clip onto the mullions without direct attachment by screws to support the curtain wall insulation. Self-locking fasteners secure the insulation panels in place. Each U-Bracket has a receiving slot to lock an "L-shaped" stiffener channel in place without the need for mechanical attachment by screws.

Traditional methods for curtain wall insulation support often require light gauge metal to be cut and fabricated onsite and fastened into mullions with screws. The Quick Clip™ U-Brackets lock into place on the mullion with a strike from a mallet. The Quick Clip™ Z-Brackets attach to the mullion using screws for corner or non-standard applications.

The insulation fasteners are faster to install than screws or weld pins and lock in by hand. The U-Brackets are designed to provide easy location for the Quick Clip™ fasteners. Unlike traditional insulation hangers with impaling pins or spikes that face out, the Quick Clip™ fasteners push in, affording workers better safety.

Mullion insulation applied below the floor is secured in place with spiral screws.

SpecSeal® Quick Clip™ Perimeter Fire Barrier Systems are used in conjunction with UL Certified mineral wool and SpecSeal® brand coatings.

## Specifications

Steel clip system having been evaluated to ASTM E2307 and designed to snap/clip onto aluminum framing members minimizing or eliminating the use of screws or other mechanical fasteners. Clips to include impaling staple to mechanically fasten curtain wall insulation to clip. Clips shall be available in a range of sizes based on mullion width and insulation thickness.

### Specified Divisions

Division 7	07 84 53	Building Perimeter Firestopping
Division 8	08 44 00	Curtain Wall and Glazed Assemblies

## Performance

- Tested per ASTM E2307 for fire resistance
- Tested for wind cycling exposure in accordance with ASTM E1233
  - Loading Equivalent to 108 mph wind for 500 cycles



## Features & Benefits

- Quick installation; fewer tools and no fasteners\*
  - Easy installation of stiffener channel
  - Increased safety by reducing cutting sharp metal and impaling pins or spikes
- \*If mullion tolerances prevent snug fit of U-Brackets, a screw will be required to hold the bracket in place

## System Selection

To find your firestop system or create a submittal, visit <https://systems.stifirestop.com/> to use System Search & Submittal Builder. You may also visit the [UL Online Certifications Directory/UL Product iQ™](#) for complete listings. (Firestop Systems).

## Technical Service

Specified Technologies Inc. provides toll free technical support to assist in product selection and appropriate installation design. UL System designs suitable for submittal or specification purposes are available on request. A complete library of technical information is provided at the company's website [www.stifirestop.com](http://www.stifirestop.com) including Safety Data Sheets (SDS's).

## Application

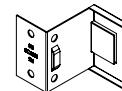
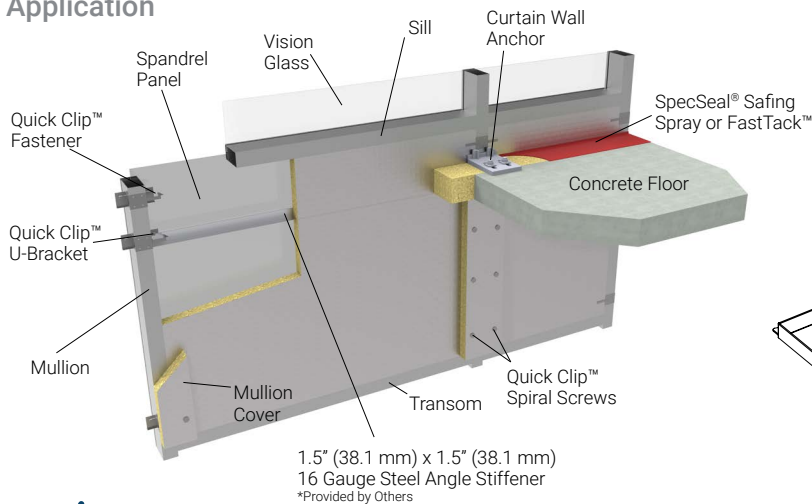

Quick Clip™ Z-Bracket used for conditions where it is impractical to install U-Bracket

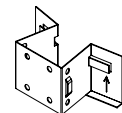

Quick Clip™ U-Bracket - Available for 2.5" (63.5 mm), 3" (76.2 mm) and 3.25" (82.55 mm) Nominal Mullions and for 2" (50.8 mm), 3" (76.2 mm) and 4" (101.6 mm) Insulated Thicknesses

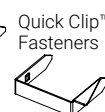
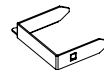

Quick Clip™ Fasteners



3.75" (95.25 mm) Quick Clip™ Spiral Screws

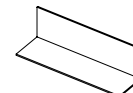





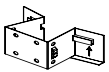
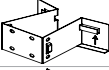
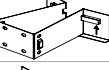

1.5" (38.1 mm) by 1.5" (38.1 mm)  
16 Gauge Galvanized Steel Angle Stiffener  
\*Provided by Others

Patent Numbers: 10329761, 10329762, 10626603

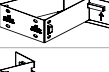
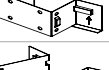
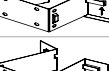
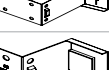
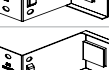
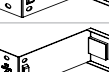
# SpecSeal® Quick Clip™ Perimeter Fire Barrier System

## ORDERING INFORMATION

Catalog Number	UPC Number	Description	Product Image	Mullion Width		Insulation	Weight (Each)	Case Qty.	Material
				Min.	Max.				
SC25020	730573100011	Quick Clip™ U-Bracket*				2" (50.8 mm)	0.31 lbs (0.14 kg)	100	Heat treated galvanized steel
SC25030	730573100028	Quick Clip™ U-Bracket*		2.375" (60.3 mm)	2.525" (65.1 mm)	3" (76.2 mm)	0.28 lbs (0.13 kg)	100	
SC25040	730573100035	Quick Clip™ U-Bracket*				4" (101.6 mm)	0.32 lbs (0.15 kg)	100	
SC30020	730573100042	Quick Clip™ U-Bracket				2" (50.8 mm)	0.25 lbs (0.11 kg)	100	
SC30030	730573100059	Quick Clip™ U-Bracket		2.875" (73 mm)	3.2" (81.2 mm)	3" (76.2 mm)	0.30 lbs (0.14 kg)	100	Heat treated galvanized steel
SC30040	730573100066	Quick Clip™ U-Bracket				4" (101.6 mm)	0.35 lbs (0.16 kg)	100	
SC32520	730573100073	Quick Clip™ U-Bracket				2" (50.8 mm)	0.25 lbs (0.11 kg)	100	Heat treated galvanized steel
SC32530	730573100028	Quick Clip™ U-Bracket		3.125" (79.4 mm)	3.45" (87.6 mm)	3" (76.2 mm)	0.30 lbs (0.14 kg)	100	
SC32540	730573100097	Quick Clip™ U-Bracket				4" (101.6 mm)	0.34 lbs (0.15 kg)	100	
SC20H	730573100103	Quick Clip™ Z-Bracket				2" (50.8 mm)	0.13 lbs (0.06 kg)	100	Galvanized steel
SC30H	730573100110	Quick Clip™ Z-Bracket		All	All	3" (76.2 mm)	0.15 lbs (0.07 kg)	100	
SC40H	730573100127	Quick Clip™ Z-Bracket				4" (101.6 mm)	0.14 lbs (0.06 kg)	100	
SB2020	730573100257	Quick Clip™ Fastener		All	All	All	0.04 lbs (0.02 kg)	100	Galvanized steel
SA375	730573100264	Quick Clip™ Spiral Screw		All	All	All	0.02 lbs (0.01 kg)	1000	Galvanized steel

\* For single extrusion mullions only

IMPORTANT NOTICE: ALL STATEMENTS, TECHNICAL INFORMATION, AND RECOMMENDATIONS CONTAINED HEREIN ARE BASED UPON TESTING BELIEVED TO BE RELIABLE, BUT THE ACCURACY AND COMPLETENESS THEREOF IS NOT GUARANTEED.

STI TYPICALLY WARRANTIES ITS PRODUCTS FOR ONE FULL YEAR. FOR COMPLETE DETAILS OF OUR STANDARD WARRANTY, PLEASE VISIT [WWW.STIFIRESTOP.COM/LEGAL/WARRANTY](http://WWW.STIFIRESTOP.COM/LEGAL/WARRANTY)

MADE IN THE USA - © 2020 SPECIFIED TECHNOLOGIES INC.