

PRODUCT BULLETIN

Sto Thermo Dowel and Accessories

Product Numbers: 81637, 81638, 81639, 81642, 81643

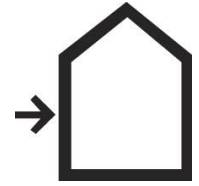

PRODUCT DESCRIPTION

Sto Thermo Dowel is a pre-assembled fastener and dowel for use in StoTherm® ci Mineral Systems to attach insulation board to supporting wall construction. It is specifically designed to minimize thermal conductivity.

FEATURES	BENEFITS
Recessed screw head with thermal plug or cap	Reduced thermal bridging effect minimizes heat energy loss and risk of fastener telegraphing
Stiff, flat, thin, large diameter washer design	Facilitates surface mounting and hiding of washer with base coat; increases wind load capacity
Countersunk installation (for 3" [76mm] or greater insulation thickness)	Optimizes thermal efficiency and surface aesthetics
Star drive fasteners	Less wear and tear on drill bits

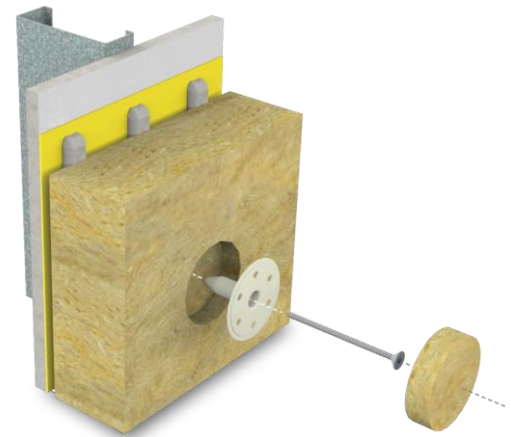

PRODUCT SELECTION DATA

Sto Part No.	Sto Part Name	Typical Product Use	Total Length (tip to Dowel Head)	Screw length	Threaded Length	Packaging ¹
81637-010	Sto Thermo Dowel S120	Surface Mount over 2" insulation or Countersunk in 3" insulation into 16 or 18 Ga steel studs	4-3/4" (120mm)	4" (100mm)	2-1/4" (57mm)	100 per carton
81637-011	Sto Thermo Dowel S140	Countersunk in 4" insulation into 16 or 18 Ga Steel Studs	5-1/2" (140mm)	4-3/4" (120mm)	2-1/4" (57mm)	100 per carton
81637-023	Sto Thermo Dowel S200	Countersunk in 6" insulation into Steel Studs with 2 layers of 5/8" gypsum sheathing	8-7/8" (200mm)	7-3/32" (180mm)	2-9/16" (65mm)	100 per carton
81637-012	Sto Thermo Dowel W120	Surface mount over 2" insulation or Countersunk in 3" insulation into wood studs	4-3/4" (120mm)	4" (100mm)	2-3/8" (60mm)	100 per carton
81637-013	Sto Thermo Dowel W140	Countersunk in 4" insulation into wood studs	5-1/2" (140mm)	4-3/4" (120mm)	2-3/8" (60mm)	100 per carton
81637-014	Sto Thermo Dowel C115	Countersunk in 3" insulation into concrete	4-1/2" (115mm)	3-1/8" (80mm)	2-3/8" (60mm)	100 per carton
81637-007	Sto Thermo Dowel C135	Countersunk in 4" insulation into concrete and CMU	5-5/16" (135mm)	4" (100mm)	2-3/8" (60mm)	100 per carton
81637-019	Sto Thermo Dowel C195	Countersunk in 6" insulation into concrete and CMU	7-11/16" (195mm)	5-7/16" (138mm)	2-3/8" (60mm)	100 per carton

1. Note: packaging includes thermal plugs. Does not include Sto Thermo Cap Wool which must be ordered separately.





IMPORTANT! Steel and wood stud wall assemblies take into account SINGLE LAYER sheathing thickness up to 5/8 inch (16mm) thick. If a wall assembly contains other components such as a second layer of sheathing, or a cavity, size the fastener such that: 1. For steel framing minimum 3/4 inch (19mm) penetration is achieved – minimum 3 thread penetration through steel; 2. For wood framing minimum 1 inch (25mm) penetration into wood framing is achieved. CMU wall assembly is based on 1-3/8 inch (35mm) smooth faced hollow core or grouted normal weight CMU.

PRODUCT BULLETIN

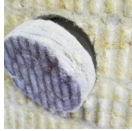

Sto Thermo Dowel and Accessories

Product Numbers: 81637, 81638, 81639, 81642, 81643

ACCESSORIES

Sto Part No.	Depiction	Sto Product Name	Product Use	Packaging
81638-001		Sto Thermo Cap Wool	¾ in (20mm) thick thermal cap for countersunk fasteners to reduce thermal bridging	100 per carton
81639-001		Sto Thermo Countersunk Tool	Countersinks and drives Sto Thermo Dowels into supporting construction in one step with uniform depth	1 per plastic container
81642-004		Sto Thermo Countersunk Tool Bits TX30-M8 x 31	Drill bit for use with Sto Thermo Countersunk Tool	5 per plastic bag
81642-005		Sto Thermo Countersunk Tool Bits TX30-M8 x 52	Drill bit for use with Sto Thermo Countersunk Tool	5 per plastic bag
81643-001		StoThermo Dowel Washer VT2G	4-5/16in (110mm) diameter washer used in combination with StoThermo Dowel for increased wind load resistance	100 per box

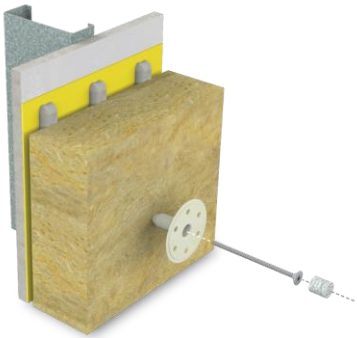
APPLICATION





<p>A. Steel or Wood Studs – Surface Mount for 2" (51mm) thick insulation: insert the proper length and type Sto Thermo Dowel into the insulation. Use a screw gun with star head drill bit to fasten into steel or wood stud faming members until the dowel sits FLUSH with the surface of the insulation. Do not penetrate the insulation board with the dowel. Insert the Thermal Plug in the dowel recess until flush with the surface of the dowel.</p>		
---	---	---

PRODUCT BULLETIN

Sto Thermo Dowel and Accessories

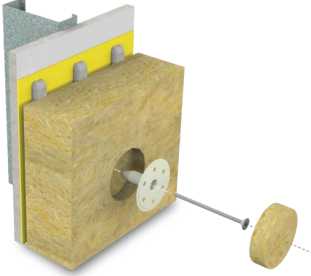
Product Numbers: 81637, 81638, 81639, 81642, 81643

APPLICATION (continued)

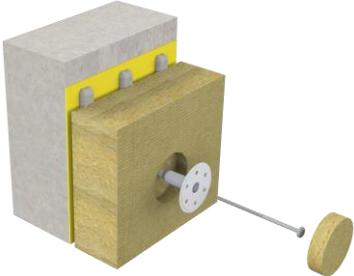
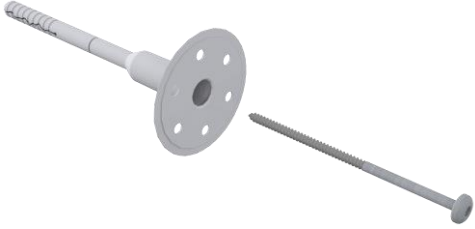
<p>B. Steel or Wood Studs – Countersunk for minimum 3" (76mm) thick insulation: insert the proper length and type Sto Thermo Dowel into the insulation. Use the Sto Thermo Countersunk Tool to drive the dowel into supporting construction until the stop device contacts the insulation board surface. Insert the Sto Thermo Cap Wool until flush with the surface of the insulation board.</p>		
		
<p>C. Countersunk for minimum 3" (76 mm) thick insulation – Concrete. Pre-drill the concrete with a 3/8" (10mm) diameter drill bit to a depth sufficient to receive the Sto Thermo Dowel. Use the Sto Thermo Countersunk Tool to drive the Sto Thermo Dowel C into supporting construction until the stop device contacts the insulation board surface. Insert the Sto Thermo Cap Wool until flush with the surface of the insulation</p>		

Sto Corp.
 3800 Camp Creek Parkway
 Building 1400, Suite 120
 Atlanta, GA 30331
 Tel: 404-346-3666
 Toll Free: 1-800-221-2397
 Fax: 404 346-3119
www.stocorp.com

Revision Number: A9.0
 Date: 03/2022

ATTENTION
 This product is intended for use by qualified professional contractors, not consumers, as a component of a larger construction assembly as specified by a qualified design professional, general contractor or builder. It should be installed in accordance with those specifications and Sto's instructions. Sto Corp. disclaims all, and assumes no, liability for on-site inspections, for its products applied improperly, or by unqualified persons or entities, or as part of an improperly designed or constructed building, for the nonperformance of adjacent building components or assemblies, or for other construction activities beyond Sto's control. Improper use of this product or use as part of an improperly designed or constructed larger assembly or building may result in serious damage to this product, and to the structure of the building or its components. **STO CORP. DISCLAIMS ALL WARRANTIES EXPRESSED OR IMPLIED EXCEPT FOR EXPLICIT LIMITED WRITTEN WARRANTIES ISSUED TO AND ACCEPTED BY BUILDING OWNERS IN ACCORDANCE WITH STO'S WARRANTY PROGRAMS WHICH ARE SUBJECT TO CHANGE FROM TIME TO TIME.** For the fullest, most current information on proper application, clean-up, mixing and other specifications and warranties, cautions and disclaimers, please refer to the Sto Corp. website, www.stocorp.com