

HERITAGE® VINTAGE® ARCHITECTURAL ASPHALT SHINGLES

PHILLIPSBURG, KS



SHINGLES BEGIN TO AGE AS SOON AS THEY ARE EXPOSED TO NATURE. BUILDINGS EXPERIENCE AGING FACTORS DIFFERENTLY, SO IT IS DIFFICULT TO PREDICT HOW LONG SHINGLES WILL LAST. TAMKO PROVIDES A LIMITED WARRANTY FOR MANY PRODUCTS, THAT INCLUDES A BINDING ARBITRATION CLAUSE AND OTHER TERMS AND CONDITIONS WHICH ARE INCORPORATED HEREIN BY REFERENCE. YOU MAY OBTAIN A COPY OF THE LIMITED WARRANTY AT TAMKO.COM OR BY CALLING 1-800-641-4691.

WARNING: Use of this product in an assembly that includes polyurethane foam insulation (including without limitation an application directly to the underside of a roof deck or within a wall assembly) may cause premature degradation or failure of this product. We continue to evaluate compatibility of polyurethane foams with our asphalt building products. Chemical incompatibility, off-gassing after application and excess heat during and after application of polyurethane foams may affect the performance of asphalt and modified asphalt building products and metal fasteners used with those products.



IMPORTANT SAFETY INFORMATION: Do not install until all appropriate safety precautions have been read and understood. The TAMKO Safety Data Sheet (SDS) is available at tamko.com/sds. Always use appropriate fall protection equipment and wear appropriate personal protective equipment (PPE) when working with this product. Moisture, frost, debris or other material will decrease the traction and can cause slippery conditions when walking on the product. **Applicator safety is of utmost importance.**

THESE ARE THE MANUFACTURER'S APPLICATION INSTRUCTIONS FOR ROOFING CONDITIONS DESCRIBED. TAMKO BUILDING PRODUCTS LLC ASSUMES NO RESPONSIBILITY FOR LEAKS OR OTHER DEFECTS RESULTING FROM FAILURE TO FOLLOW THE MANUFACTURER'S INSTRUCTIONS. FAILURE TO FOLLOW THESE INSTRUCTIONS WILL ADVERSELY AFFECT COVERAGE UNDER THE LIMITED WARRANTY AND ARBITRATION AGREEMENT. SEE THE LIMITED WARRANTY FOR DETAILS.

CHECK LOCAL BUILDING CODES TO DETERMINE SUITABILITY OF THIS PRODUCT FOR YOUR INTENDED USE.

INFORMATION INCLUDED IN THESE APPLICATION INSTRUCTIONS WAS CURRENT AT THE TIME OF PRINTING. TO OBTAIN A COPY OF THE MOST CURRENT VERSION OF THESE APPLICATION INSTRUCTIONS, VISIT US ONLINE AT WWW.TAMKO.COM OR CALL US AT 1-800-641-4691.

THIS TAMKO® PRODUCT IS COVERED BY A LIMITED WARRANTY AND ARBITRATION AGREEMENT, THE TERMS OF WHICH ARE PRINTED ON THE WRAPPER.

IN COLD WEATHER (BELOW 40°F), CARE MUST BE TAKEN TO AVOID DAMAGE TO THE EDGES AND CORNERS OF THE SHINGLES.

IT IS NOT NECESSARY TO REMOVE THE PLASTIC STRIP FROM THE SHINGLES.

HERITAGE® VINTAGE® ARCHITECTURAL ASPHALT SHINGLES

PHILLIPSBURG, KS



I. ROOF DECK

These shingles are for application to roof decks consisting of plywood, oriented strand board (OSB) or sheathing boards capable of receiving and retaining fasteners, and to inclines of not less than 2" per foot.

Shingles must be applied in strict accordance with the application instructions. TAMKO assumes no responsibility for leaks or defects resulting from improper application, or failure to properly prepare the surface to be roofed over.

STANDARD ROOF: For roofs having pitches equal to or greater than 4" per foot and up to but less than 21" per foot (4:12 and up to but less than 21:12).

LOW-SLOPE: For roofs having pitches 2" per foot up to but less than 4" per foot (2:12 up to but less than 4:12), refer to special instructions titled "Low Slope Application."

MANSARD ROOF OR STEEP SLOPE: For roofs having pitches equal to or greater than 21" per foot, refer to special instructions titled "Mansard Roof or Steep Slope Roof."

NEW ROOF DECK CONSTRUCTION: Roof deck must be smooth, dry and free from warped surfaces. It is recommended that metal drip edges be installed at eaves and rakes.

PLYWOOD: All plywood shall be exterior grade as defined by APA - The Engineered Wood Association. Plywood shall be a minimum of 3/8" thickness and applied in accordance with the recommendations of APA - The Engineered Wood Association.

ORIENTED STRAND BOARD: Oriented strand board shall be exterior grade as defined by APA - The Engineered Wood Association, minimum 7/16" thickness, APA-rated in accordance with Voluntary Standard PS 2 and applied in accordance with the recommendations of APA - The Engineered Wood Association.

SHEATHING BOARDS: Boards shall be well-seasoned tongue-and-groove boards and not over 6" nominal width. Boards shall be a 1" nominal minimum thickness. Boards shall be properly spaced and nailed.

**TAMKO DOES NOT RECOMMEND HERITAGE® VINTAGE®
FOR RE-ROOFING OVER AN EXISTING ROOF.**

2. VENTILATION

Inadequate ventilation of attic spaces can cause accumulation of moisture in winter months and a build-up of heat in the summer. These conditions can lead to:

1. Vapor condensation.
2. Buckling of shingles due to deck movement.
3. Rotting of wood components.
4. Premature failure of roof.

To ensure adequate ventilation and circulation of air, the ventilation system must include inlets and outlets. This may be accomplished with a combination of ridge and soffit vents or by using gable end vents. FHA minimum property standards require one square foot of net free ventilation area to each 150 square feet of space to be vented.

This may be reduced to one square foot of ventilation area per 300 square feet if at least 40% and not more than 50% of venting is provided not more than 3 feet below the ridge and if a Class I or II vapor barrier is installed on the warm-in-winter side of the ceiling in climate zones 6, 7, and 8 as recommended by the 2018 International Residential Code. For more information consult your design professional. If the ventilation openings are screened, the total area should be doubled.

IT IS PARTICULARLY IMPORTANT TO PROVIDE ADEQUATE VENTILATION.

3. FASTENERS

NAILS: TAMKO requires the use of nails as the method of application. Standard type roofing nails should be used. Nail shanks should be made of minimum 12 gauge wire, and a minimum head diameter of 3/8". Nails should be long enough to penetrate 3/4" into the roof deck. Where the deck is less than 3/4" thick, the nails should be long enough to penetrate completely through decking and extend at least 1/8" through the roof deck. Drive nail head flush with the shingle surface.

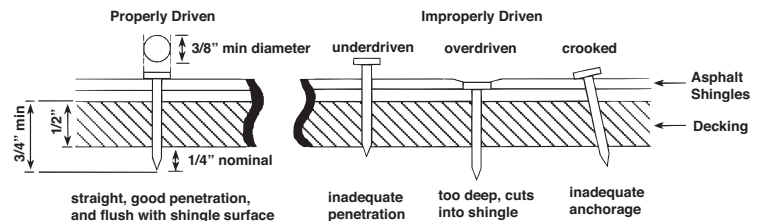

WIND CAUTION: Extreme wind velocities can damage these shingles after application when proper sealing of the shingles does not occur. This can especially be a problem if the shingles are applied in cooler months or in areas on the roof that do not receive direct sunlight. These conditions may impede the sealing of the adhesive strips on the shingles. The inability to seal down may be compounded by prolonged cold weather conditions and/or blowing dust. In these situations, hand sealing of the shingles is required. To ensure quicker sealing, apply a quarter-sized dab of any adhesive meeting ASTM D4586, Type I, to the back of each tab. Place the adhesive a minimum of 1" from the side of the tab and 1" up from the bottom of each tab. Press shingle firmly into the adhesive. For maximum wind resistance along rakes, install any TAMKO starter shingle including sealant or cement shingles to the underlayment and each other in a 4" width of any adhesive meeting ASTM D4586, Type I. Caution: Apply ONLY a thin uniform layer of adhesive less than 1/8" thick. Excessive amounts can cause blistering of the shingles and may soften the asphalt in certain underlayments resulting in the asphalt flowing, dripping and staining. Shingles must also be fastened according to the fastening instructions described below.

3. FASTENERS (continued)

Correct placement of the fasteners is critical to the performance of the shingle. **If the fasteners are not placed as shown in the diagram as described below, this will result in the termination of TAMKO's liabilities under the Limited Warranty and Arbitration Agreement.** TAMKO will not be responsible for damage to shingles caused by winds in excess of the applicable MPH as stated in the Limited Warranty and Arbitration Agreement. See Limited Warranty and Arbitration Agreement on the wrapper or tamko.com for details.

FASTENING PATTERNS:

FASTENERS MUST BE PLACED 6" FROM THE TOP EDGE OF THE SHINGLE LOCATED HORIZONTALLY AS FOLLOWS:

1) STANDARD FASTENING PATTERN:

For use on decks with slopes 2" per foot up to but less than 21" per foot.

One fastener 1-1/2" from each end and one 10-3/4" from each end and one 20" from one end of the shingle for a total of 5 fasteners. (See Standard Fastening Pattern illustrated below.)

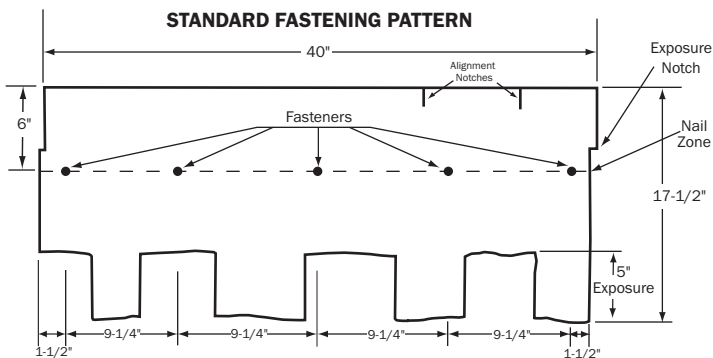

2) MANSARD ROOF OR STEEP SLOPE FASTENING PATTERN:

For use on decks with slopes equal to or greater than 21" per foot.

Use standard nailing instructions with four additional nails placed 6" from the butt edge of the shingle making certain nails are covered by the next (successive) course of shingles. Each shingle tab must be sealed underneath with any adhesive meeting ASTM D4586, Type I immediately upon installation. Quarter-sized dabs of cement must be applied to shingles with a 5" exposure, use 9 fasteners per shingles. (See Mansard Fastening Patterning illustration below.)

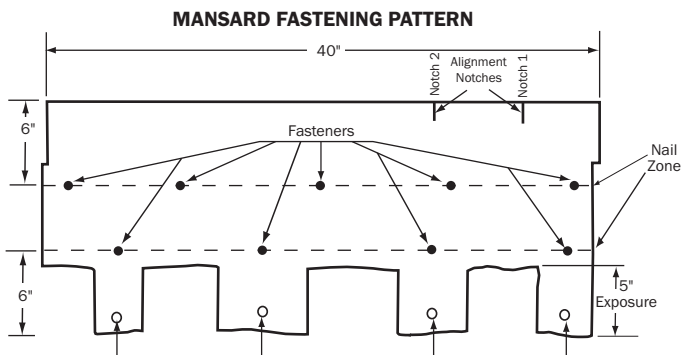

Apply under each tab 1" diameter asphalt adhesive cement.

3) HIGH WIND WARRANTY FASTENING PATTERN:

For High Wind Warranty Application requirements.

One fastener 1-1/2" from each end, one fastener 8-1/2" from each end and one fastener 16-1/4" from each end for a total of 6 fasteners per shingle. In addition to this shingle fastening pattern requirement for High Wind Application, TAMKO also requires the use of TAMKO® starter shingles including sealant strip at eaves and rakes. Alternatively, along rakes, cement shingles to the underlayment and each other in a 4" width of any adhesive meeting ASTM D4586, Type I. Caution: Apply ONLY a thin uniform layer of adhesive less than 1/8" thick. Excessive amounts can cause blistering of the shingles and may soften the asphalt in certain underlayments resulting in the asphalt flowing, dripping and staining. High Wind Application is offered on new construction or complete tear-off applications only. It is not offered for re-cover applications. If High Wind Application requirements are not followed, the High Wind Application Warranty MPH, as stated on Table I in the Limited Warranty and Arbitration Agreement, reverts to the Standard Application Wind Warranty MPH limit. (See High Wind Fastening Pattern illustrated below.)

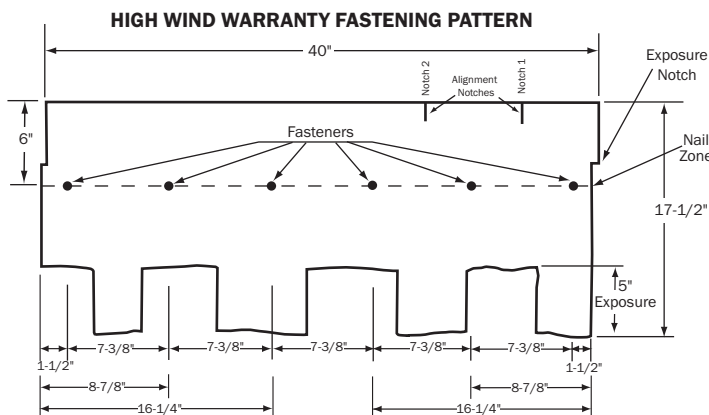

HERITAGE® VINTAGE® ARCHITECTURAL ASPHALT SHINGLES

PHILLIPSBURG, KS



4. UNDERLAYMENT

UNDERLAYMENT: An underlayment must be applied over the entire deck before the installation of TAMKO® shingles. Failure to add underlayment can cause premature failure of the shingles, which is not covered by TAMKO's Limited Warranty and Arbitration Agreement.

Products which are acceptable for use as underlayment are:

Asphalt Saturated Felt Underlayments

- Any TAMKO® non-perforated asphalt saturated organic felt
- A non-perforated asphalt saturated organic felt which meets ASTM D226 or ASTM D4869

Specialty Underlayments

- Synthetic Guard™ Plus Underlayment or Synthetic Guard™ Underlayment
- A polymeric underlayment designed for use with asphalt shingles which meets ASTM D8257
- TAMKO® Moisture Guard® Ice & Rain Underlayment, TW Underlayment or TW Metal and Tile Underlayment (additional ventilation may be required—contact TAMKO's Technical Services Department for more information)
- A self-adhesive underlayment designed for use with asphalt shingles which meets ASTM D1970

For Asphalt Saturated Felt Underlayments

Apply the felt when the deck is dry. On roof decks with slopes 4" per foot and greater apply the felt parallel to the eaves lapping each course of the felt over the lower course at least 2". Where ends join, lap the felt 4". If left exposed, the felt may be adversely affected by moisture and weathering. Laying of the felt and the shingle application must be done together.

For All Other Specialty Underlayments

On roof decks with slopes 4" per foot and greater, apply the underlayment parallel to the eaves in accordance with underlayment application written instructions. The underlayment should not be left exposed for a longer period of time than is specified in the underlayment application written instructions. The final roof covering must be installed before the structure is exposed to adverse weather conditions, such as wind driven rain, high wind, hail, ice storms, etc.

In areas where ice builds up along the eaves or a back-up of water from frozen or clogged gutters is a potential problem, TAMKO® Moisture Guard®, TW Metal and Tile Underlayment or TW Underlayment (or any specialty eaves flashing product) may be applied to eaves, rakes, ridges, valleys, around chimneys, skylights or dormers to help prevent water damage. Contact TAMKO's Technical Services Department for more information.

5. APPLICATION INSTRUCTIONS

STARTER COURSE: Two starter course layers must be applied prior to application of Heritage® Vintage® shingles.

FIRST STARTER COURSE APPLICATION

Starter course may consist of TAMKO® Shingle Starter, TAMKO® 10-inch Starter, TAMKO® Perforated Starter, or self-sealing 3-tab shingles. If self-sealing 3-tab shingles are used, remove the exposed tab portion and install with the factory applied adhesive adjacent to the eaves. Attach the starter course with approved fasteners along a line parallel to and 1-1/2" to 3" above the eaves edge. The starter course should overhang the eave edge 1/4" to 3/4" and the rake edge 3/8" to 3/4" if drip edge flashing is not used along the eaves or rakes. If drip edge flashing is present, install shingles even with the drip edge or overhang the starter course over the drip edge up to 3/4". Minimizing overhang at eaves and rakes is recommended to improve wind resistance of the installed system.

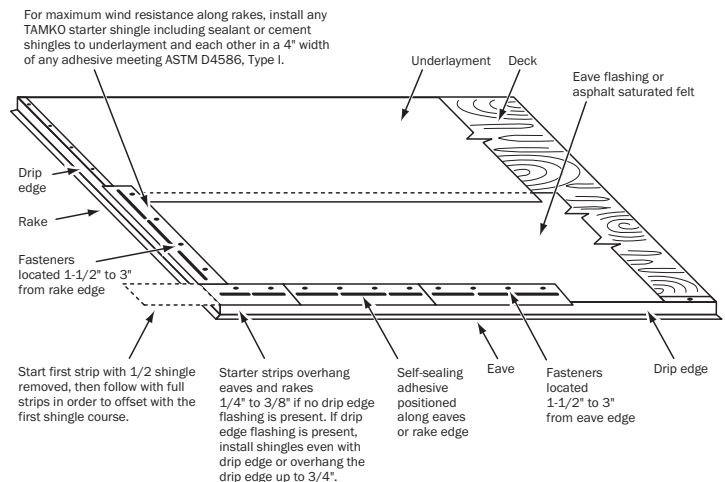

HERITAGE® VINTAGE® ARCHITECTURAL ASPHALT SHINGLES

PHILLIPSBURG, KS



5. APPLICATION INSTRUCTIONS (continued)

SECOND STARTER COURSE APPLICATION

Over the first starter course at the eave edge, install Heritage Vintage Starter and begin at the left rake edge with a full size shingle and continue across the roof nailing the Heritage Vintage Starter along a line parallel to and 6" from the eave edge.

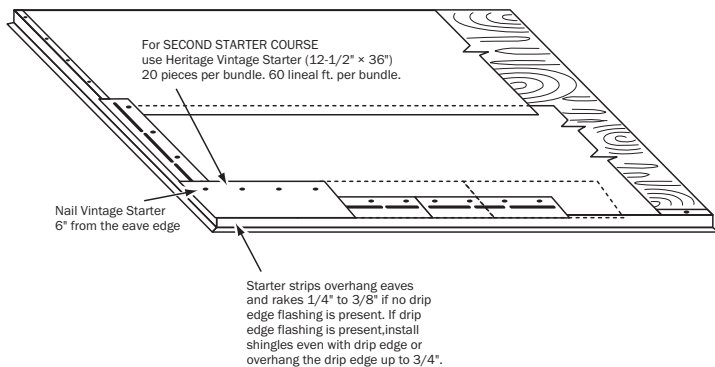

SHINGLE APPLICATION OVER STARTERS

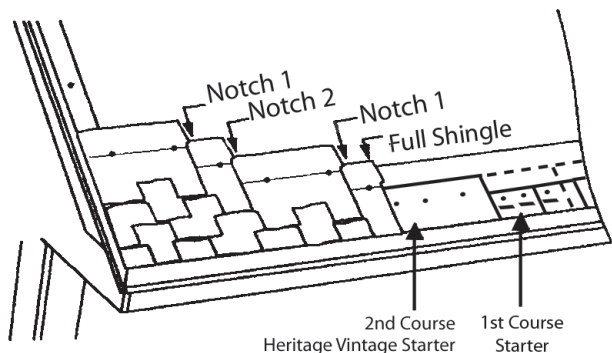

SHINGLE APPLICATION STARTING NEAR VALLEY

IMPORTANT: USE ALIGNMENT NOTCHES TO START SHINGLE COURSES, DO NOT MEASURE IT.

Some roof layouts may not allow for application to begin at a rake edge, and may require you to begin shingle application near a valley. To begin shingle application starting near a valley, strike a chalk line from the top point of the ridge down to the eave on one side of the valley. This will be the reference line to shingle from, starting on the right side of the line using the left to right instructions. Fill in the left side of the chalk line applying shingles right to left. Install both sides of the chalk line as shingles courses go up the roof. **Refer to Valley Application in Section 7 of these instructions to complete the valley.** As shingles are applied towards the valley trim the last shingle trimmed to less than 12" in length to finish a course running in to a valley. If necessary, trim the adjacent shingle in the course to allow longer portion to be used.

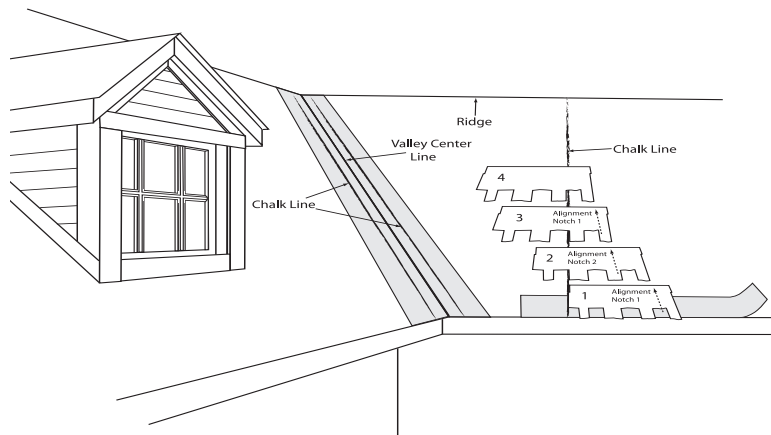

SHINGLE APPLICATION FOR LEFT TO RIGHT INSTALLATION:

IMPORTANT: USE **ALIGNMENT NOTCHES** TO START SHINGLE COURSES, DO NOT MEASURE IT.

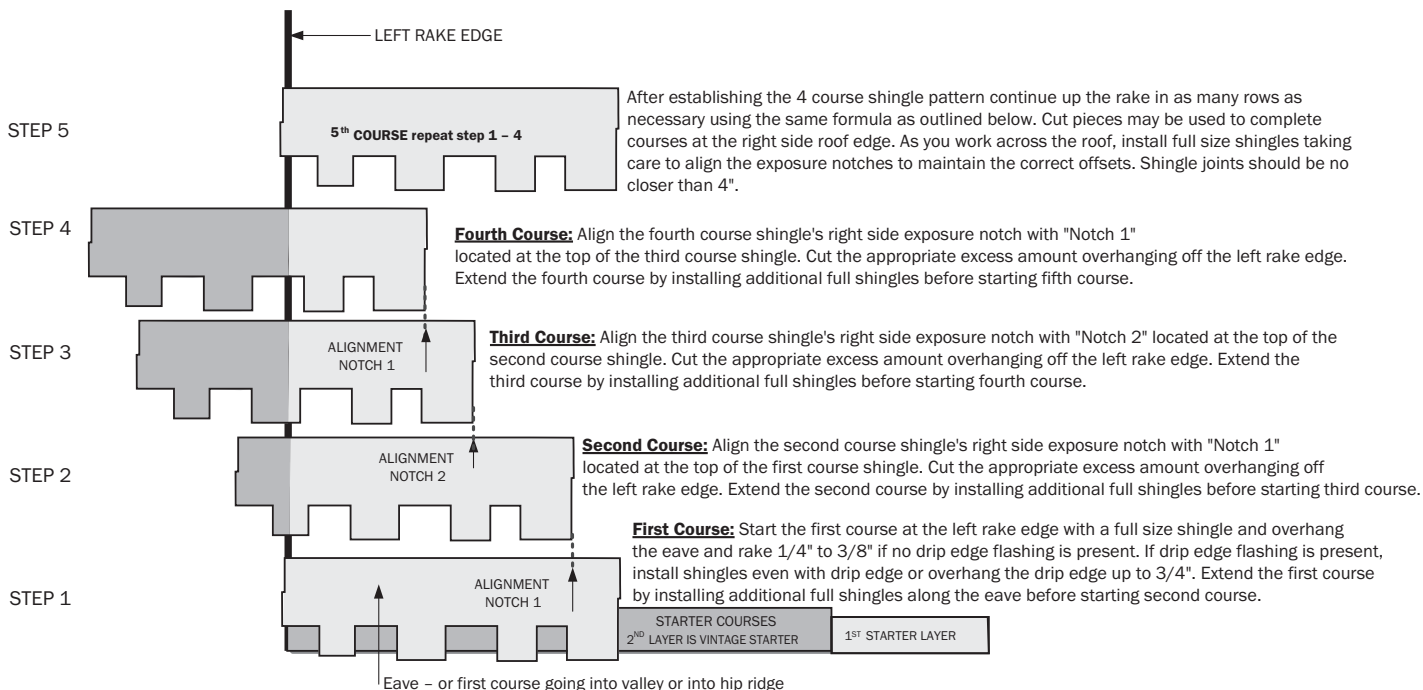

SHINGLE APPLICATION FOR RIGHT TO LEFT INSTALLATION:

IMPORTANT: USE **ALIGNMENT NOTCHES** TO START SHINGLE COURSES, DO NOT MEASURE IT.

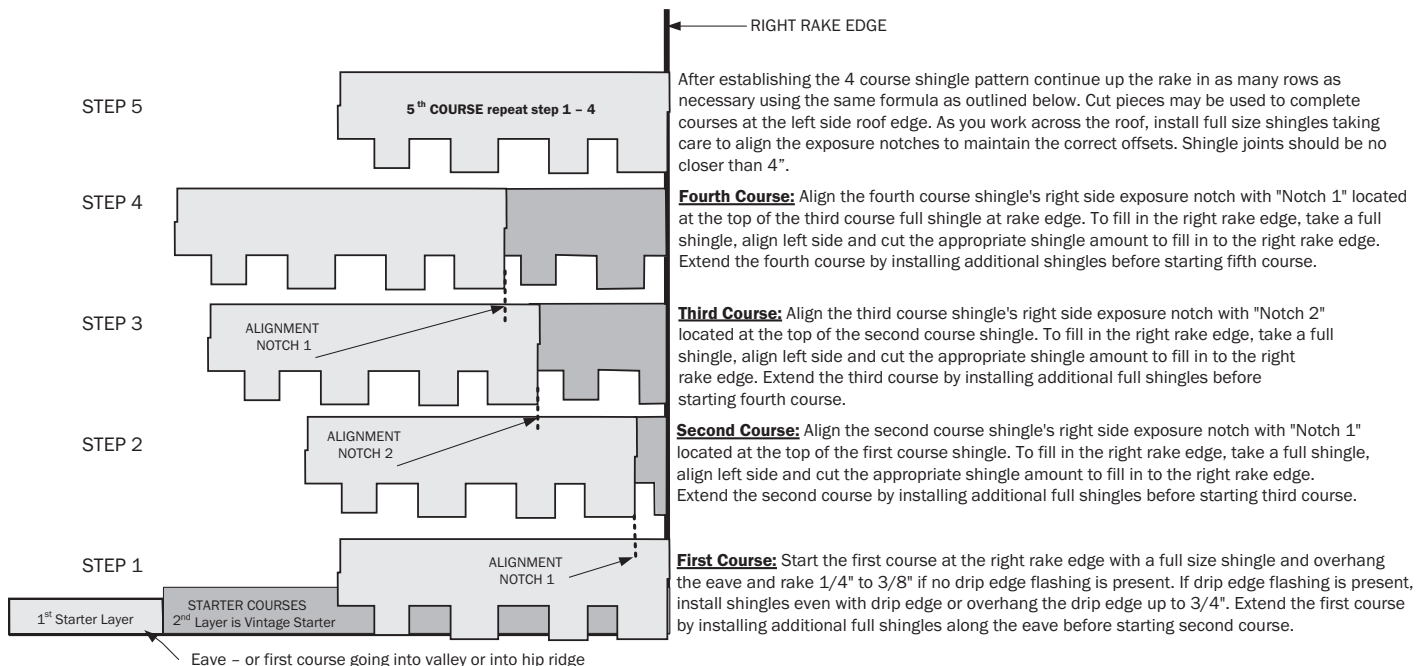

SHINGLE APPLICATION FOR RIGHT TO LEFT INSTALLATION CONTINUED:

IMPORTANT: USE **ALIGNMENT NOTCHES** TO START SHINGLE COURSES, DO NOT MEASURE IT.

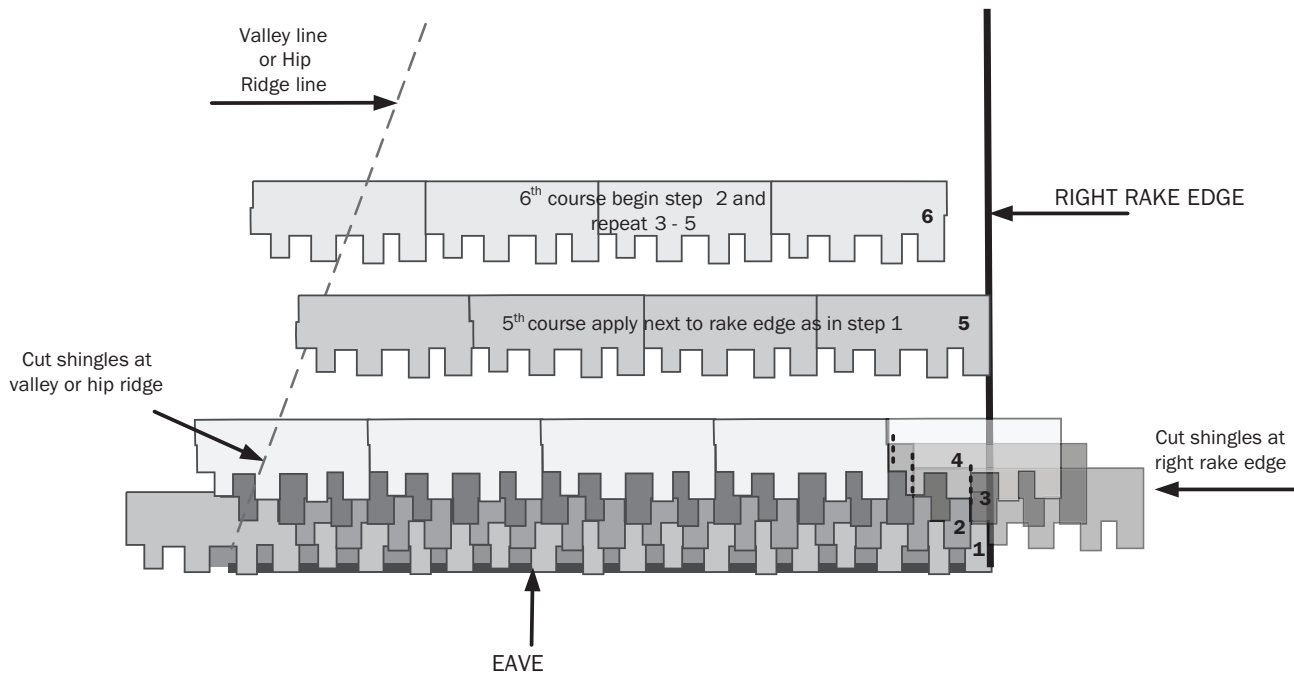

SHINGLE APPLICATION ON A HIP ROOF:

IMPORTANT: USE **ALIGNMENT NOTCHES** TO START SHINGLE COURSES, DO NOT MEASURE IT.

For shingle application on a hip roof, strike a chalk line from the top point of the hip roof (at the ridge) down to the eave. This will be the reference line to shingle from, starting on the right side of the line use the left to right instructions. Fill in the left side if the chalk line applying shingles right to left. Install both sides of the chalk line as shingle courses go up the roof. As you work across the roof, install full size shingles taking care to align the exposure notches to maintain the correct offsets. Trim the last shingle in each course along the hip edge and finish with Heritage Vintage Hip and Ridge shingle products to complete the ridge. **Refer to Hip and Ridge Fastening detail in Section 8 to complete the ridge.**

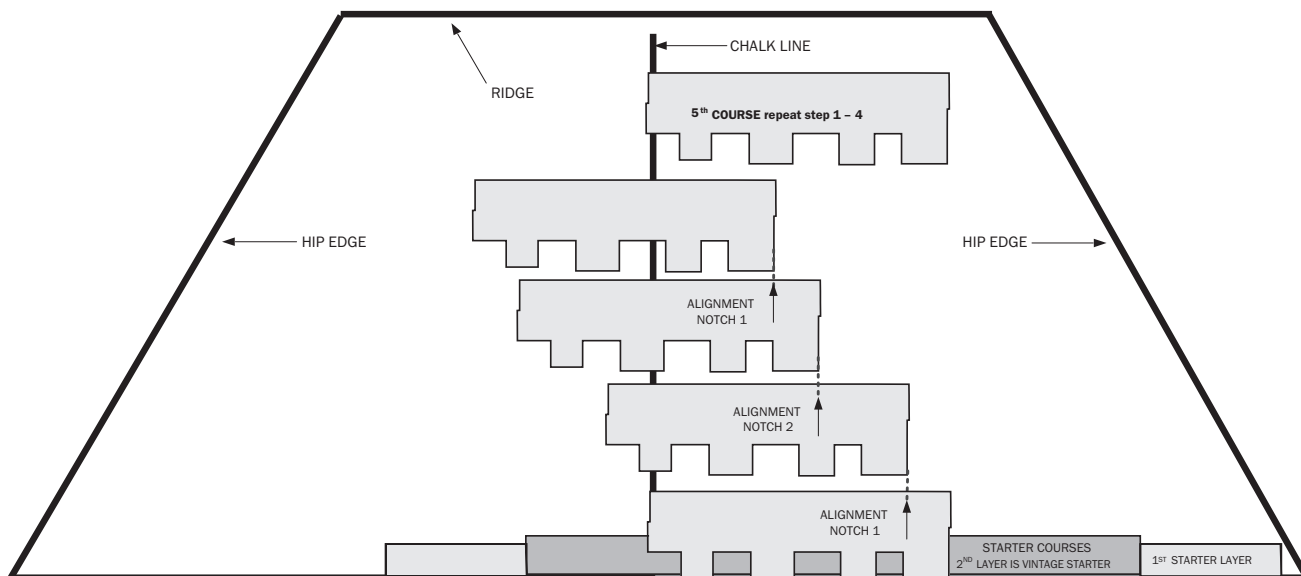

6. LOW SLOPE APPLICATION

On pitches 2" per foot up to but less than 4" per foot (2:12 up to but less than 4:12) cover the deck with two layers of underlayment. Begin by applying the underlayment in a 1/2-sheet width plus 1/2 width of the side lap (i.e. for 36" wide asphalt saturated felt with a 2" side lap, the width would be 19") along the eaves. Place a full sheet width over the starter piece, completely overlapping it. All succeeding courses will be positioned to overlap the preceding course by 1/2-width sheet plus 1/2 width of the side lap. If winter temperatures average 25°F or less, thoroughly cement the laps of the entire underlayment to each other with any adhesive meeting ASTM D4586 Type I from eaves and rakes to a point of at least 24" inside the interior wall line of the building. As an alternative, one layer of TAMKO® Moisture Guard®, TW Metal and Tile Underlayment, or TW Underlayment self-adhering underlayment may be used in lieu of the double coverage underlayment.

7. VALLEY APPLICATION

IMPORTANT: PRIOR TO INSTALLATION, WARM SHINGLES TO PREVENT DAMAGE WHICH CAN OCCUR WHILE BENDING SHINGLES TO FORM VALLEY.

TAMKO recommends an open valley construction with Heritage® Vintage® shingles.

To begin, center a sheet of TAMKO Moisture Guard®, TW Underlayment or TW Metal and Tile Underlayment in the valley. After the underlayment has been secured, install the recommended corrosion resistant metal (26 gauge galvanized metal or an equivalent) in the valley. Secure the valley metal to the roof deck. Overlaps should be 12" and cemented.

Following valley metal application; a 9" to 12" wide strip of TAMKO Moisture Guard®, TW Underlayment or TW Metal and Tile Underlayment should be applied along the edges of the metal valley flashing (max. 6" onto metal valley flashing) and on top of the valley underlayment. The valley will be completed with shingle application.

SHINGLE APPLICATION INSTRUCTIONS (OPEN VALLEY)

- Snap two chalk lines, one on each side of the valley centerline over the full length of the valley flashing. Locate the upper ends of the chalk lines 3" to either side of the valley centerline.
- The lower end should diverge from each other by 1/8" per foot. Thus, for an 8' long valley, the chalk lines should be 4" either side of the centerline at the eaves and for a 16' valley 5".

As shingles are applied toward the valley, trim the last shingle in each course to fit on the chalk line. Never use a shingle trimmed to less than 12" in length to finish a course running into a valley. If necessary, trim the adjacent shingle in the course to allow a longer portion to be used.

- Clip 1" from the upper corner of each shingle on a 45° angle to direct water into the valley and prevent it from penetrating between the courses.
- Form a tight seal by cementing the shingle to the valley lining with a 3" width of any adhesive meeting ASTM D4586, Type I.

CAUTION: Adhesive must be applied in smooth, thin, even layers. Excessive use of adhesive will cause blistering to this product. TAMKO assumes no responsibility for blistering.

VINTAGE OPEN VALLEY DETAIL

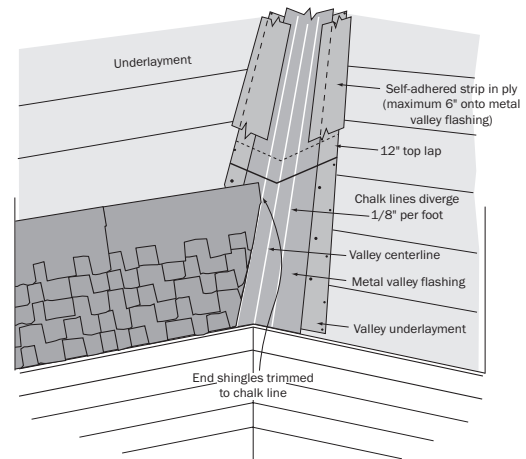

8. HIP AND RIDGE FASTENING DETAIL

Apply shingles up to a hip or ridge from both sides of the roof before finishing the intersection. To facilitate finishing, adjust the last few courses so that the ridge capping will adequately cover the top courses of shingles equally on both sides of the ridge.

To apply the capping, bend each shingle along the centerline so that it will extend an equal distance on each side of the hip or ridge. Chalk lines may assist in proper alignment. In cold weather, warm the shingle until it is pliable before bending.

Apply the shingles with a 5" exposure, beginning at the bottom of the hip or from the end of the ridge opposite the direction of the prevailing winds. See Figure 1. Secure each shingle as illustrated in Figure 2, with one fastener on each side, 5-1/2" back from the exposed end and 1" up from the edge. The length of the fastener should be long enough to penetrate through the roofing material and 3/4" into the wood decking or completely through the decking.

In high wind areas, it may be advisable, at the discretion of the roofing contractor, to use a spot of sealant to minimize blow off problems.

It is recommended that a 2-layer application of Vintage 12x12 Hip and Ridge shingles be applied to all Heritage® Vintage® roofs to enhance the overall appearance. When the second layer is applied, offset this layer by 1/4" to create a "shadow" effect. See Figure 3.

Figure 1

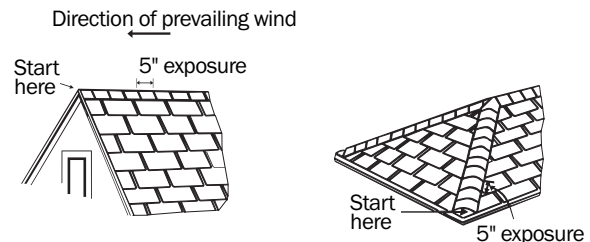

Figure 2

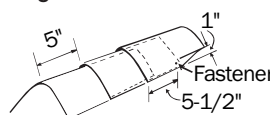

Figure 3

