

THESE ARE THE MANUFACTURER'S APPLICATION INSTRUCTIONS FOR THE ROOFING CONDITIONS DESCRIBED. TAMKO BUILDING PRODUCTS, INC. ASSUMES NO RESPONSIBILITY FOR LEAKS OR OTHER ROOFING DEFECTS RESULTING FROM FAILURE TO FOLLOW THE MANUFACTURER'S INSTRUCTIONS. THIS PRODUCT IS COVERED BY A 50 YEAR LIMITED WARRANTY. TO OBTAIN A COPY OF THE LIMITED WARRANTY CALL 800-641-4691 OR VISIT OUR WEBSITE AT tamko.com. WE RECOMMEND YOU CONSULT A PROFESSIONAL ROOFING CONTRACTOR FOR INSTALLATION OF YOUR TAMKO METALWORKS ROOF.

PREPARATION & BASIC REQUIREMENTS FOR THE METAL SHINGLE ROOFING SYSTEM

- METALWORKS shingles are for application to roof decks with slopes of at least 3 inches per foot and up to vertical application. For slopes 3 inches per foot and up to and including of 4 inches per foot, TW Metal & Tile Underlayment or TW Underlayment must be used over entire deck area for new roof construction or where complete roof tear off is done. Refer to page 5 "UL Class A Fire Rated Roof" for more information.
- Fasteners are to be 11 or 12 gauge galvanized steel nails or screws with 3/8" (1cm) heads. Stainless Steel nails and other stainless steel fasteners should not be used with this product. The minimum length of fastener is 1 1/2" (3.8cm). Fasteners must penetrate the deck by at least 1/2" (1.3cm). Check Local Building Codes for maximum allowable roof layers.
- TAMKO recommends all field formed flashing be formed from METALWORKS Trim Coil.
- Sealant shall be one part urethane contractor grade sealant.

Care for the Material

- Boxes should be kept in a dry place and under opaque tarps while on the site.
- Use care when stacking boxes, For shingle boxes the maximum stacking level is three high. Do not stack pallets over two high.
- Boxes should be stacked on their sides. Do not lay boxes flat. Boxes are marked with arrows indicating the proper stacking direction.
- Avoid having loose materials on the roof.

Sheathing

NEW ROOF AND ROOF REPLACEMENT: With new construction or where complete roof tear off is done, roof deck must be smooth, dry and free from warped surfaces.

RECOVER OVER EXISTING ASPHALT SHINGLES: Before installing MetalWorks Steel Shingles over existing asphalt shingles old metal drip edges must be removed or cut back flush with fascia at eaves and rake edges.

PLYWOOD: All plywood shall be exterior grade as defined by APA - The Engineered Wood Association. Plywood shall be a minimum of 3/8" thickness and applied in accordance with the recommendations of APA - The Engineered Wood Association.

Ventilation

VENTILATION: Inadequate ventilation of attic spaces can cause accumulation of moisture in winter months and a build up of heat in the summer. These conditions can lead to:

- Vapor Condensation
- Deterioration of insulation, wood and other construction materials
- Mold and mildew
- Ice damming on the roof

To help ensure adequate ventilation and circulation of air, the ventilation system must include inlets and outlets. This may be accomplished with a combination of ridge and soffit vents or by using gable end vents. FHA minimum standards require one square foot of net free ventilation area to each 150 square feet of space to be vented. This may be reduced to one square foot

Traffic

- Walk only on the top portion of the shingles and avoid walking on the locks/seams. (See Figure 1)
- Wear soft-soled shoes.



APPROPRIATE FALL PROTECTION METHODS SHOULD BE USED WHENEVER WORKING ON ROOFS. Use caution, product may be slippery.

Ventilation (continued)

of ventilation area per 300 square feet if at least 40% and not more than 50% of venting is provided not more than 3 feet below the ridge or if a Class I or II vapor barrier is installed on the warm in winter side of the ceiling in climate zones 6, 7, and 8 as recommended by the 2012 International Residential Code. For more information consult your design professional. If the ventilation openings are screened, the total area should be doubled. **PROPER VENTILATION IS ESSENTIAL**

Underlayment and Ice/Rain Protection Underlayment

- Products which are acceptable for use as underlayment are: TAMKO No. 30 Asphalt Saturated Organic Felt A non-perforated asphalt saturated organic felt which meets ASTM: D226, Type II, TAMKO SuperX™ 30 Underlayment, TAMKO TW Metal & Tile Underlayment, TW Underlayment or Synthetic Guard Plus.
- In all cases the entire roof must be covered (prior to MetalWorks Steel Shingle application) with a minimum non-perforated asphalt saturated organic felt underlayment which meets ASTM D226, Type II underlayment (double layer at eaves and valleys). This applies to new roof replacement or recover applications.
- For roof slopes of 3 inches per foot up to and including 4 inches per foot, TAMKO's self-adhering TW Metal and Tile Underlayment or TW Underlayment must be applied over the entire deck for new roof construction or where complete roof tear off is done. This should not be done when applying MetalWorks Steel Shingles over an existing shingle roof. **When installing TAMKO's self adhering TW Metal and Tile Underlayment or TW Underlayment over the entire deck surface proper ventilation is essential.**
- Apply the underlayment parallel to the eaves, starting with the lowest course, lapping each course 2" (5.1cm). Where ends join, lap 4" (10.2cm).
- When covering hips and valleys, always overlap felt by extending 24" beyond the center line of the hip or valley.
- Ice and Rain:** For new construction or where complete roof tear off is done and where there is a possibility of ice forming along eaves or in valleys causing a backup of water, TAMKO TW Metal and Tile Underlayment or TW Underlayment should be used in lieu of traditional felt underlayment. Extend from the eave's edge to a point at least 24" (61cm) beyond the exterior wall line of the building and along the entire length of the valley, 19" (48cm) on each side of the centerline.

SHINGLES BEGIN TO AGE AS SOON AS THEY ARE EXPOSED TO NATURE. BUILDINGS EXPERIENCE AGING FACTORS DIFFERENTLY, SO IT IS DIFFICULT TO PREDICT HOW LONG SHINGLES WILL LAST. THAT'S WHY TAMKO PROVIDES A 50-YEAR LIMITED WARRANTY FOR METALWORKS STEEL SHINGLES THAT INCLUDES A BINDING ARBITRATION CLAUSE AND OTHER TERMS AND CONDITIONS WHICH ARE INCORPORATED HEREIN BY REFERENCE. YOU MAY OBTAIN A COPY OF THE LIMITED WARRANTY AT TAMKO.COM OR BY CALLING 1-800-641-4691.

THE LIMITED WARRANTY CAN BE FOUND ON PAGES 7 AND 8.

APPLICATION INSTRUCTIONS Starter/Eave Flashing

- Remove existing drip edge or cut back flush with fascia and cut back existing shingles flush with fascia at eaves and gables ①. (for recover over existing asphalt shingles only).
- Apply first full width course of underlayment at eave (both new construction and recover over existing shingles) and install METALWORKS Starter Flashing ②. (TW Metal and Tile Underlayment or TW Underlayment should only be used on new construction or where complete roof tear off has been done).
- Fasten Starter with 2 rows of nails 18" o.c. in a staggered pattern between the two rows.③. Fasten through vertical face of Starter into fascia 18" o.c. ④.
- Overlap Starter Flashing min. 2" at joints.
- Apply underlayment to entire roof (new construction, roof replacement, and recover) and lap to the eave edge of the Starter Flashing. Provide a second layer of underlayment at the eave ⑤ for new construction, roof replacement, and recover. (See page 1 "Underlayment and Ice/Rain Protection Underlayment")

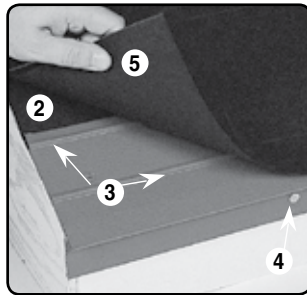

Gable/Rake Detail

- Install METALWORKS Gable flashing over underlayment at rake and over Starter at eave ①.
- A 12" wide strip of TW Metal and Tile Underlayment or TW Underlayment shall be installed down the rake edge with 1" overlapping the vertical edge of the roof sheathing.
- Install Gable Flashing with clips 24" o.c. ② Place fastener in hole near bottom of clip. Face-fasten through rake side of Gable Flashing 24" o.c. ③ using METALWORKS color matched screws.
- To join the Gable Flashings, trim the upper flashing and slide it over the lower flashing, overlapping 1-1/2 inches. The gable flashing on a dormer must be mitered to fit.

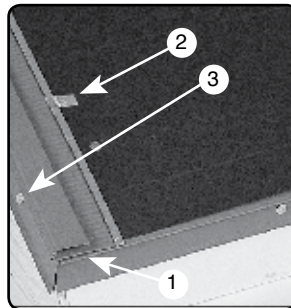

Valley Detail

- When METALWORKS Valley Flashing finishes at the eave, trim the bottom of the Valley Flashing to the correct angle and crimp over the Starter Flashing. Miter the Valley Flashing to conform to the eave line. ①

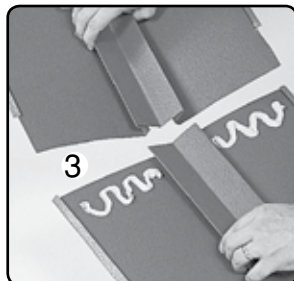
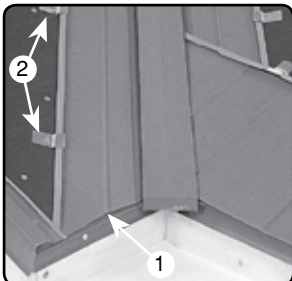

Valley Detail (continued)

- Valley Flashing with a dormer finishes over the last course of shingles below the dormer's eave.
- Place clip on one side of the valley flashing and fasten. Next, apply pressure to the valley flashing, place clip on the opposite side, and fasten to assure the Valley Flashing is seated. Do not fasten through the Valley Flashing.
- Install the Valley Flashing with clips 18 inches on-center ②.
- To join two Valley Flashings,③ slide the upper flashing over the lower flashing, overlapping 2 inches. Apply one-part urethane contractor-grade sealant to completely seal all joints.
- When two Valley Flashings meet at a ridge, miter the flashings to be flush at the ridge. Where the the two flashings join, overlay with Hip and Ridge Seal.

Installing Shingles

- Start shingle installation at bottom left corner of roof field with a full shingle ①. For this first shingle, cut a 2-inch notch in the return of the bottom locking lip for water to drain freely ③.
- Lock first course to Starter Flashing and fasten with Clips (min. 3 per shingle)②. Place fastener through hole in clip. In areas requiring specific uplift ratings additional fastening schedules can be found by referencing UL Evaluation Report ER18590-01.
- Install second shingle and each subsequent shingle locking the left side first, then pushing the panel up to engage the bottom lock. (Note: ensure bottom lock is fully engaged).
- At the end of a row, as you approach a valley, sidewall or gable flashing, cut the right side of the shingle off to fit in the remaining space, sliding the shingle inside the corresponding flashing.
- Cut 2" notch in the return of the bottom locking lip (butt edge of shingle) in line with gables or sidewalls to allow water to drain freely (first course only) ③.
- The numbers 2, 3 and 4 are embossed on the top lock. To start second course cut the shingle at number 2, for third course cut at number 3, then fourth course cut at number 4. To begin the fifth course of shingles start with a full shingle and continue up the rake using the same formula.
- Note - METALWORKS steel shingles must be locked into place properly. Use of a wooden block or rubber mallet to tap the shingles may help to seat locks properly.

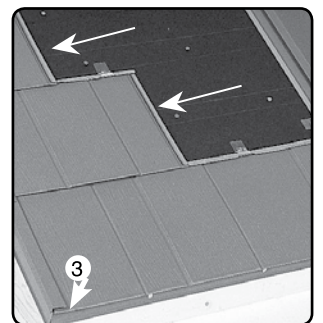
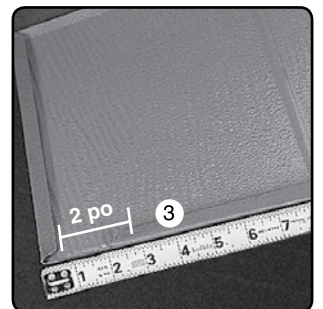
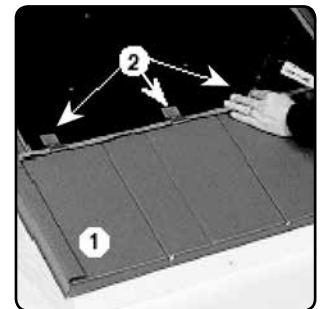

Important

Important: All detail work demands careful consideration. It is important to consider water flow and overlap materials in proper sequence!

Installing Shingles (continued)

- When coming out of a valley, vary the shingle length to ensure staggered appearance. Cut the shingles to fit to the valley angle ④. The first shingle is a full length shingle. The remaining shingles and courses coming out of the valley are cut so the shingle side locks are staggered up the roof. As each course is calculated, remember to take into account the amount of shingle that is hidden in the receiver on the Valley Flashing. Shingle rows should be staggered in the following order when coming off a valley or hip: full shingle, 1/2 shingle, 3/4 shingle, 1/4 shingle. (See illustration)
- For the first course of shingles into or out of a valley, cut a 6-inch notch in the backside of the return on the bottom locking lip of the first shingle only ⑤. In all remaining valley shingles, cut a 1/2 inch V-shape notch in the return of the bottom locking lip approximately 6 inches from the center of the valley for drainage. ⑥
- At ridges and hips, line the cut edge of shingles up against one another and fasten through shingles with at least two fasteners per shingle.

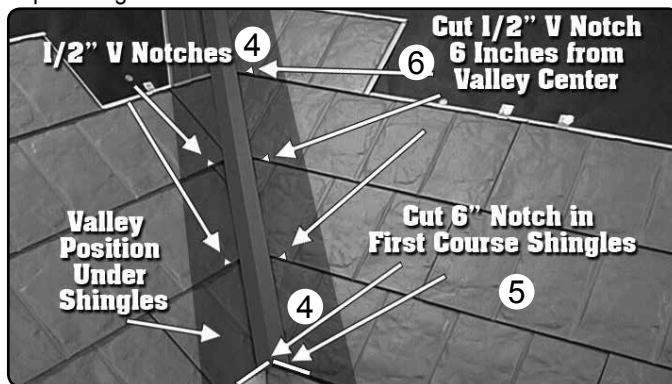

Hip and Ridge Caps

- 12" Hip & Ridge Caps can be used on the Hip or Ridge. Hip Caps should only be used on the hip of the roof.
- **Apply double sided Hip & Ridge Seal** ① centered over the point where the shingles come together.
- Install Tapered Hip Caps or 12" Hip & Ridge Caps over Hip & Ridge Seal. Tapered Hip Caps fasten with Clips ②. Please note: METALWORKS 12" Hip & Ridge Caps with a built-in nailing hem do not require clips.
- Face-fasten the first and last cap of each section. Fasten through the cap on all four corners using nails or screws. Apply sealant over exposed fasteners.
- At the junction of two Valley Flashings, install 12" Hip & Ridge Caps to hide the sealed joint.
- Alternate method for extreme wind areas: Tapered Hip Caps may be face-fastened. Fasten through the cap on all four corners using nails or screws. If using nails, apply sealant over exposed fasteners.
- In ridge vent application, install the ridge vent over the shingles apply double sided Hip & Ridge Seal to the ridge vent then install 12" Hip & Ridge Caps over the vent ③. Depending on the type of vent used, Hip & Ridge Seal may not be applicable.

Note: Ensure that fasteners penetrate the roof deck min. 1/2".

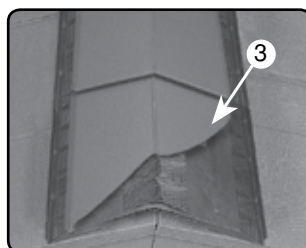
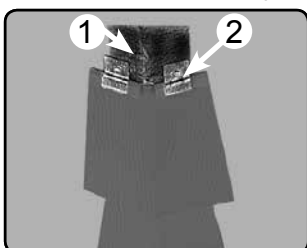

Pipe/Vent Detail

- Cut the shingle(s) to fit tightly around the pipe/vent, apply one-part urethane contractor-grade sealant around penetration ①.
- Cut and fold back the top lock of the shingle that the pipe or vent flashing will cover ②.

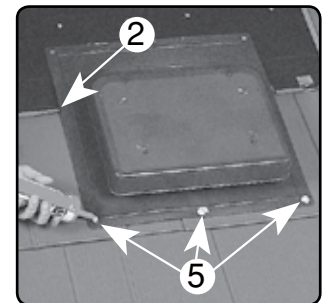
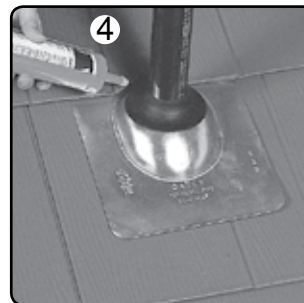
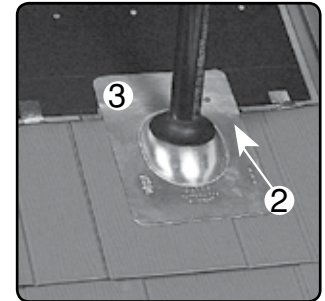
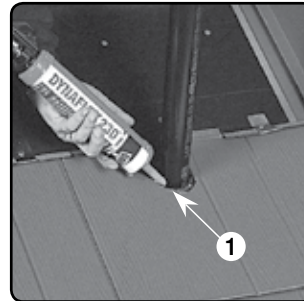

- Apply sealant to the underside of the flashing ③. Install so that the next full shingle will lap over the flashing. Apply sealant at the bottom of the shingle where it meets the top of the pipe/vent ④. Apply sealant over exposed fasteners ⑤.

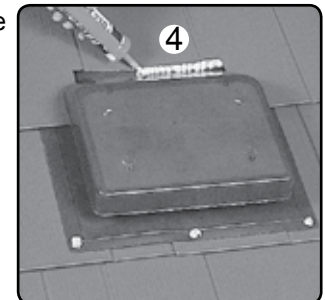

Headwall Detail

- When working around dormers, apply TAMKO's TW Moisture Wrap tape, with a minimum width of 6 inches, to the headwall area first and then to the sidewalls, wrapping the lower end from the sidewall back on top of the headwall. Apply sealant on top of the TW Moisture Wrap at the two front corners of the dormer.
- Cut shingles to fit below the dormer and fasten through the top of the shingle ①. Along the bottom corner of the dormer, cut the top lock of the shingle so that the sidewall flashing will lie flat over the shingle ②.
- Headwall Flashing should be formed from METALWORKS Trim Coil ③. The flashing strip should be bent to extend a minimum of 3-1/2 inches up the vertical wall and overlap the last course of shingles by a minimum of 3-1/2 inches ④.

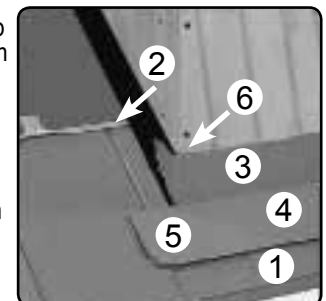

Headwall Detail (continued)

- Trim the headwall flashing so there are rounded corners that overlap the shingle. ⑤ Cut the flashing in order to wrap the vertical wall around to the sidewall ⑥.
- The Headwall Flashing should be fastened against the headwall using nails or screws every 18 inches on-center. Install Headwall Flashing under the wall covering or existing flashings.

Sidewall Detail

- Install METALWORKS Sidewall Flashing under wall covering (siding, stucco) or existing flashing wherever possible.
- When necessary cut a slot in the wall in order to properly counter-flash Sidewall Flashing.
- Ensure Sidewall Flashing overlaps on top of the course of shingles immediately below the dormer or on top of the starter strip at the eave ①.
- To join Sidewall Flashing, trim lower flashing and slide together with a 2 inch overlap.
- At a dormer, Sidewall Flashing is cut ② and crimped ③ under and at an angle to be flush with the front dormer wall.
- The bottom of the sidewall lock area that is exposed on top of the shingle should be cut and folded under.
- Apply additional sealant at the junction of the headwall and sidewall before fastening the Sidewall Flashing.
- Fasten the Sidewall Flashing to the dormer wall 18 inches on-center.
- Install the Sidewall Flashing to the roof deck with clips 24 inches on-center ④. Install the remaining shingles around the dormer.

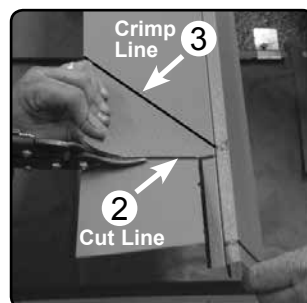
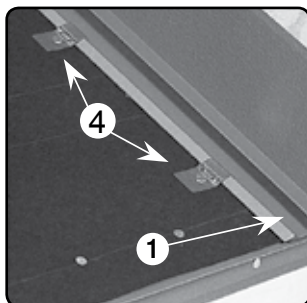

Pitch Transition Detail

- Pitch transitions must be addressed with METALWORKS specialty materials such as Trim Coil or Starter Flashing. **Do not simply bend the shingles.**
- Install TAMKO's TW Metal and Tile Underlayment or TW Underlayment on top of the last course of shingles under the transition flashing.
- Complete lower roof and install transition flashing using METALWORKS Trim Coil over last course of shingles ①. Bend Trim Coil as if forming headwall flashing, and attach above the transition area using nails or screws 18" o.c. ②. Flashing should overlap last course of shingles minimum 3-1/2 inches. Also lap underlayment over the top portion of the transition flashing. (not shown)
- Install METALWORKS Starter Flashing over transition flashing ③. Bend the Starter Flashing's edge to lay flat and create lock for next course of shingles. Fasten Starter Flashing 18" o.c. in two rows in a staggered pattern.
- The first course of shingles above the transition lock to the new starter installed over the transition flashing ④.

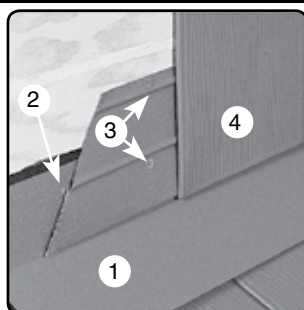

Pitch Transition Detail (continued)

- For a gambrel transition, install METALWORKS Starter Flashing at the transition point. Refer to page 2, "Starter Eave/Flashing" section.

Chimney/Skylight Detail

- Cut the last course of shingles below the chimney or skylight as close as possible to the chimney/skylight ①.
- Install headwall flashing to the bottom of the chimney/skylight using METALWORKS Trim Coil ②. (refer to Headwall Detail Section)
- Install Sidewall Flashing to the sides and extend over the last course of shingles below chimney/skylight ③ and over headwall flashing ④. (refer to Sidewall Detail Section)
- Finish shingles around chimney/skylight ⑤.

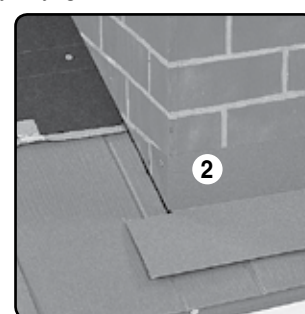
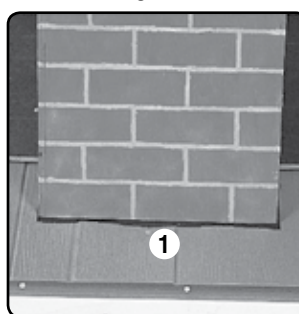

- Cut and fold back top lock of shingles(s) directly above the chimney/skylight and install a pan flashing ⑥ using METALWORKS Trim Coil so that the next course of shingles will lap over the flashing.
- Counter-flash and apply sealant as necessary.
- Large chimneys on steep roofs may require a cricket or saddle.

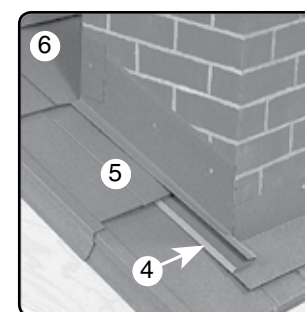
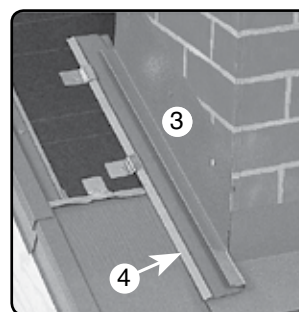

Roof Jacks

- Place protective padding (i.e. carpet, foam insulation) under roof jack to prevent damage to the shingle on which it rests ①.
- Cut and fold back the top lock of shingle to allow for roof jack insertion ②.
- Place roof jack on shingle and nail through slot in roof jack above shingle ③.
- Notch and open bottom lock on shingle directly above roof jack and install the shingle over the jack.
- After roof jack has been removed, fold opened section of bottom lock back into place and apply sealant.

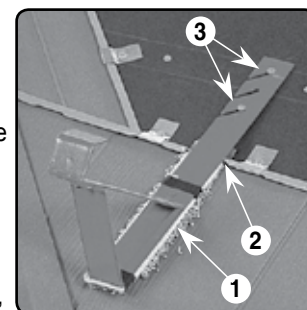

Important: All detail work demands careful consideration. It is important to consider water flow and overlap materials in proper sequence!

J-Channel

- When applying METALWORKS shingles on a vertical wall application as a siding, use J-Channel around windows, doors and other openings.

Snow Guards

- **The use of snow guards should be considered in areas where snow and ice accumulate.**
- When installing a snow guard, follow the snow guard manufacturer's recommendations for installation and placement.
- To begin, cut and fold back the top lock of shingle directly above the location of the snow guard, just as with a roof jack installation.
- Fasten above the shingle, leaving approximately two inches of the snow guard strap exposed.
- To retrofit a snow guard on an existing roof, slide the top of the snow guard under the top lock of the shingle, fasten through the shingle, apply sealant to the fasteners, and slide the sleeve over the fastener heads and under the edge of the shingle above.

Touch Up Paint

- **IMPORTANT:** This product is intended for field touch-up for **minor scratches** on METALWORKS painted product. METALWORKS product with major damage should be replaced.
- Apply touch up paint to cover all minor scratches.
- **SURFACE PREPARATION:** Prior to touch-up painting, foreign substances should be removed from the minor damage area.
- **APPLICATION:** Shake the bottle vigorously for 2 minutes. Apply one coat of METALWORKS Touch-Up Paint to the damaged area(s) only. A small brush is included inside the bottle to apply touch-up. Apply one coat of METALWORKS Touch-Up Paint to the minor damaged area only. The touch-up paint is supplied "ready to apply" and dries to a tack-free state in 15 min. at 70° Fahrenheit.
- **Use only paint supplied by TAMKO METALWORKS.**
- No spray paint of any kind should be sprayed or over sprayed on TAMKO METALWORKS products.



Removal & Replacement of Existing Shingle

- When removing a damaged shingle in the field area, it is advisable to cover the surrounding shingles to prevent possible damage to the finish.
- Slide siding zip tool under the locks and work open.
- Remove clips from the shingle and remove damaged shingle.
- Install new shingle, slide into locks and fasten with new clips.
- Reset remaining shingles and close locks.

UL Class A Fire Rated Roof

- For roof applications requiring Underwriters Laboratories, Class A fire rated roof, the entire roof area must be covered with 1/4" (6cm) DensDeck®, 1/2" gypsum board, or VersaShield® (one or two layers, depending on local building codes). One of the products listed above must be applied directly over the sheathing or existing roof, and must be fastened in accordance with the manufacturer's specifications. One layer of appropriate underlayment shall be applied over the selected product listed above prior to installing shingles.
- Recovering is acceptable when installing MetalWorks over existing Class A asphalt fiberglass shingles with a minimum 15/32" (1.2cm) thick plywood decking.
- Contact TAMKO or Underwriters Laboratories for specific application requirements for UL Class A rated systems.

UL Class C Fire Rated Roof

- Minimum 15/32" sheathing and one layer of appropriate underlayment shall be used in roof applications requiring Underwriters Laboratories, Inc. Class C fire rated roof.

Recovering

- Can be installed over up to two layers of asphalt shingles.
- Check your Local Building Code for restrictions that may apply.

Disclaimer: It is the responsibility of the installer to ensure installation is completed according to directions, and that all construction by-laws and codes are met. TAMKO is not responsible for damage of any kind resulting from faulty or improper installation.

tamko.com
metalworksroof.com

SHINGLES

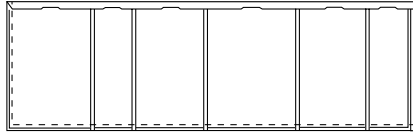

AstonWood® 28 Gauge
15 pieces per carton/49.2 sq. ft.
per carton
12 cartons per pallet

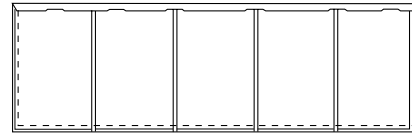

**StoneCrest® Slate &
StoneCrest® Tile**
15 pieces per carton/49.2 sq. ft.
per carton
12 cartons per pallet

SHINGLES BEGIN TO AGE AS SOON AS THEY ARE EXPOSED TO NATURE. BUILDINGS EXPERIENCE AGING FACTORS DIFFERENTLY, SO IT IS DIFFICULT TO PREDICT HOW LONG SHINGLES WILL LAST. THAT'S WHY TAMKO PROVIDES A LIMITED WARRANTY, THAT INCLUDES A BINDING ARBITRATION CLAUSE AND OTHER TERMS AND CONDITIONS WHICH ARE INCORPORATED HEREIN BY REFERENCE. YOU MAY OBTAIN A COPY OF THE LIMITED WARRANTY AT TAMKO.COM OR BY CALLING 1-800-641-4691.

METAL ACCESSORIES

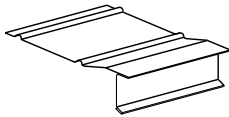

Starter/Eave Flashing
10 pieces per carton
(10' length)
30 cartons per pallet

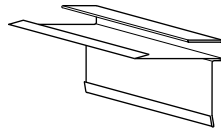

Gable/Rake Flashing
10 pieces per carton
(10' length)
24 cartons per pallet

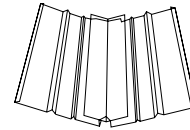

Valley
5 pieces per carton
(10' length)
12 cartons per pallet



J-Channel
10 pieces per carton
(10' length)
30 cartons per pallet

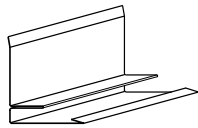

Sidewall Flashing
5 pieces per carton
(10' length)
30 cartons per pallet

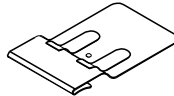

Clip
400 per carton/
100+/- per square
90 cartons per pallet



Colored Screws
50 pieces per bag

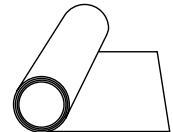

Trim Coil
22-1/4" x 50'
1 piece per carton
30 cartons per pallet

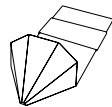

Snow Guard
100 pieces per carton
30 cartons per pallet

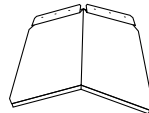

12" Ridge Cap
25 pieces per carton
(1' length)
45 cartons per pallet

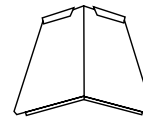

Hip Cap Tapered
StoneCrest or AstonWood
50 pieces per carton
(1' length)
32 cartons per pallet

NON-METAL ACCESSORIES

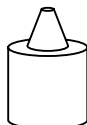

Touch-up Paint
2-oz. bottle
12 bottles per carton

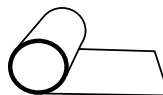

Hip & Ridge Seal
4" x 50'
1 piece per carton

Information included in this product data sheet was current at time of printing. To obtain a copy of the most current version of this product data sheet, visit us online at tamko.com or call us at 800-641-4691.

MetalWorks, AstonWood, StoneCrest and TAMKO are registered trademarks of TAMKO Building Products, Inc. Fluoropon® and Valspar® are registered trademarks of The Valspar Corporation, Inc. Kynar 500® is a registered trademark of Arkema, Inc. Hylar 5000® is a registered trademark of Solvay Solexis, Inc.