

Installation Guidelines for Mirafi® TM13C & TM14S HPTRM used in Channel and Slope Applications

Prepared by:

TenCate Geosynthetics Americas
365 South Holland Drive
Pendergrass, GA 30567
Tel 706 693 2226
Fax 706 693 4400
www.tencategeo.us

Revised: January 9, 2019

General

This document is intended as an installation guideline only and should not be construed as engineering advice. Final decision regarding proper installation details shall be written into the project specifications and is the responsibility of the project engineer. In this document, the terms “anchor(s)” and “pin(s)” are used mutually to identify a mechanical securing device. The appropriate securing device shall be site-specific based upon hydraulic conditions and soil type and shall be identified in the project specifications.

Mirafi® HPTRM Products:

Mirafi® TM13C & TM14S are shipped in rolls 12ft (3.7m) wide x 75 ft (22.9m) long and weigh approximately 60 lbs. A full roll can be handled and installed by two people using the following procedures.

Site Preparation & Vegetation:

Grade the surface of installation areas so ground is smooth and compact. When seeding prior to installation, prepare the ground surface by loosening 2” (5.08 cm) to 3” (7.62 cm) of topsoil or per the seed recommendations. All gullies, rills and any other disturbed areas must be leveled and fine graded prior to installation. (IMPORTANT: Remove all large rocks, dirt clods, stumps, roots, grass clumps, trash and other materials that would obstruct the mat from lying in direct contact with the soil surface). Spread seed before mat installation for erosion control and after mat installation for turf reinforcement. (NOTE: Sod or Hydroseeding is recommended).

Initial and terminal anchor trenches are required at the mat ends and intermittent trenches (Figure 6) must be constructed across channels at 40 ft. (12.2 m) intervals. Initial, terminal and longitudinal anchor trenches should be a minimum 12” (30 cm) deep and 12” (30 cm) wide (Fig. 2 and 3).

Channel Installation (Mirafi® TM13C):

Excavate initial and terminal trenches 12” (30 cm) deep and 12” (30 cm) wide (Figure 2 and 3) across the channel at the upper and lower end of the channel sections to be lined. Place the first mat at the downstream end of the channel. Place the end of the first mat in the initial trench and pin it at 12” (30 cm) intervals along the bottom of the trench (Figure 2). Once pinned and backfilled, the installation of the Mirafi® TM13C may continue by wrapping over the top of the trench and positioning in the upstream direction of the channel.

When starting installation of an adjacent roll (mat), allow the new mat to shingle-lap over the previously installed mat a minimum of 6" (15 cm) with upstream mat on top of downstream mat to prevent uplifting. Pin at 12" (15 cm) intervals along the entire overlap (Figure 5).

If the channel length is longer than 60 ft. (18.3 m), an intermittent trench should be utilized (Figure 6) at 40 ft. (12.2 m) intervals. Place the edges of adjacent mats in the trench by overlapping the two mats at a depth of 12" (30 cm) with a 6" (15 cm) wide horizontal section allowed for anchoring. Anchor securely with suitable pins at 12" (30 cm) intervals as shown in the detail then backfill and compact the soil.

At the upper terminal trench (Figure 3), allow the Mirafi® TM13C to conform to the trench, secure with pins, backfill, compact and then bring the mat back over the top of the trench and onto the existing mat using an 18" (45 cm) minimum overlap in the downstream direction. The overlapped area should be pinned at 12" (30 cm) intervals across the mat (as shown).

Place the outside ends of the Mirafi® TM13C mat(s) in longitudinal trenches (Figure 4) by extending the mat approx. 4 ft. (1.2 m) over the top of the channel side slope and into an excavated trench measuring at least 12" (30 cm) deep and 12" (30 cm) wide. The excavated trench should be positioned at least 2 ft. (0.6 m) back from the top crest of the side slope. Pin the mat at 12" (30 cm) intervals along the bottom of the trench, backfill and compact. Also pin the mat along the top crest of the slope by placing two rows of pins spaced approx. 12" (30 cm) apart, every 12" (30 cm) as shown in the detail. Backfill and compact excavated trench.

In addition to anchoring in all terminal trenches and overlaps, The Mirafi® HPTRM should be pinned to the ground in a 3 ft. (0.9 m) center to center pattern (Figure 11). Less frequent stapling/ pinning may be acceptable on small channels.

NOTE: For small channels of less than 8 ft. (2.4 m) wide, the Mirafi® HPTRM may be unrolled and positioned along the long axis of the channel (i.e. parallel to the flow direction).

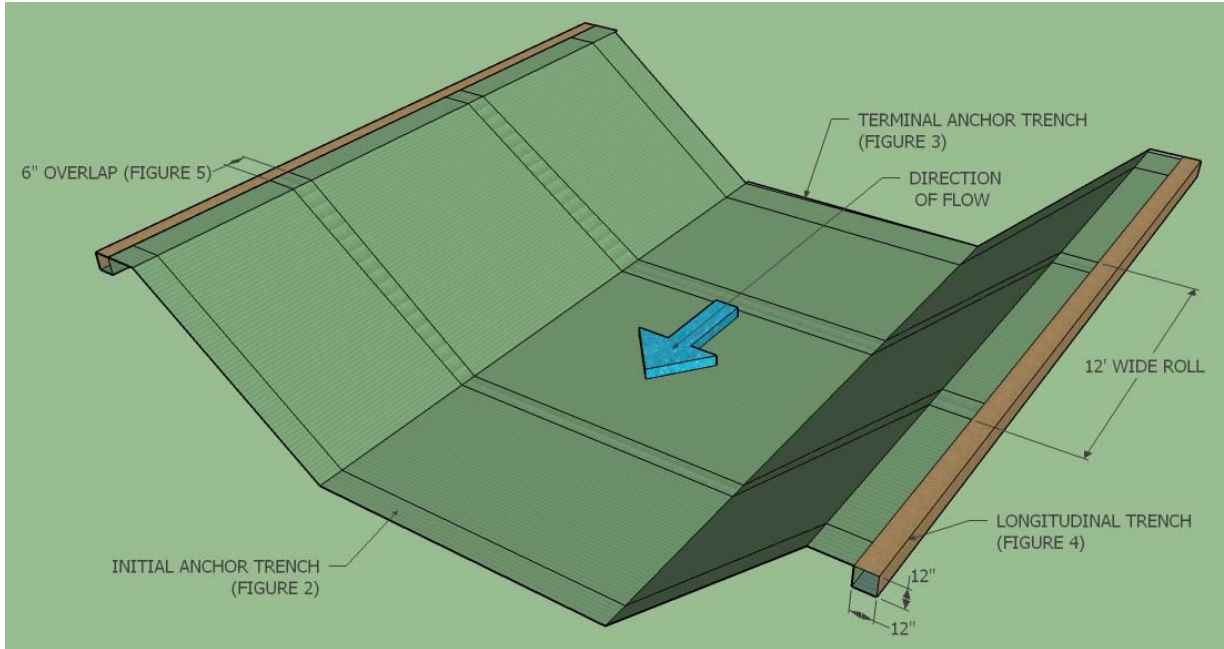

Figure 1: Typical Channel Configuration with Mirafi® TM13C

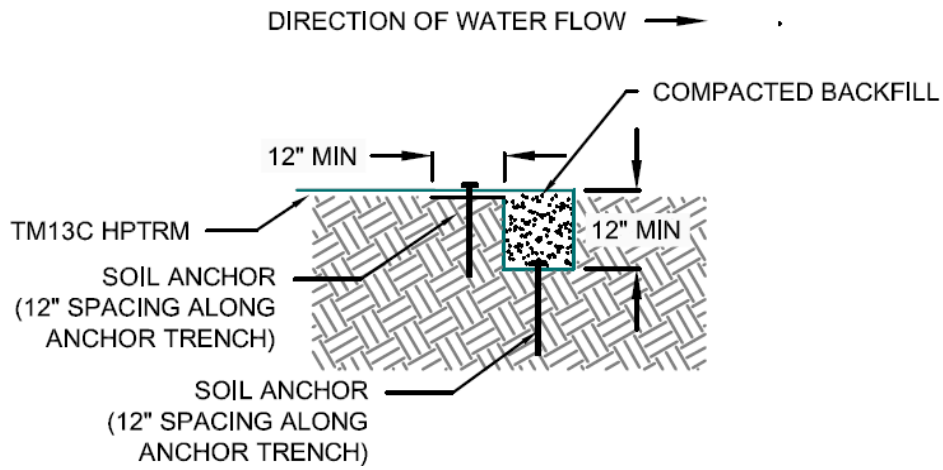

Figure 2: Initial Anchor Trench (Downstream)

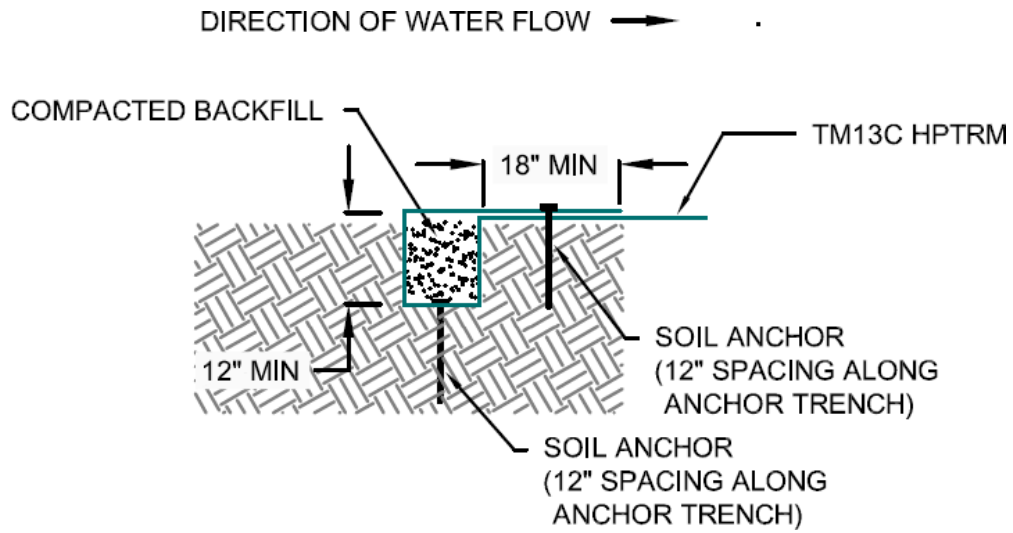

Figure 3: Terminal Anchor Trench (Upstream)

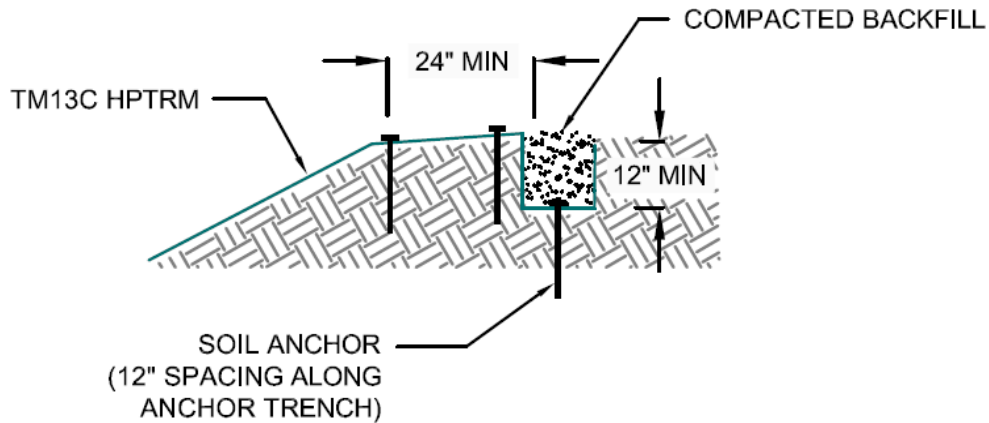

Figure 4: Longitudinal Trench

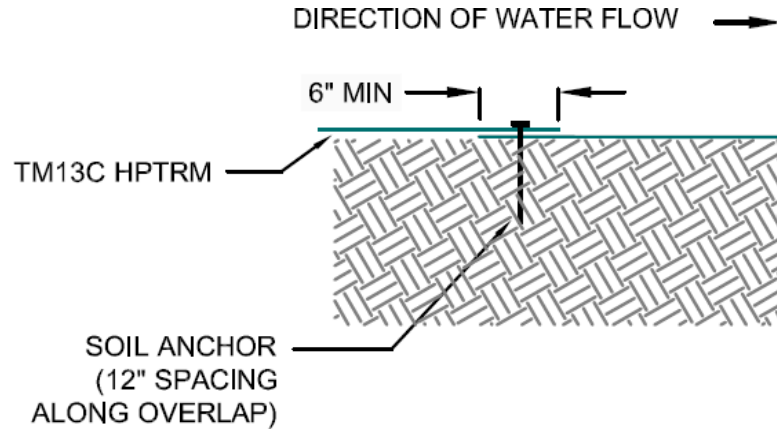

Figure 5: Typical Overlap

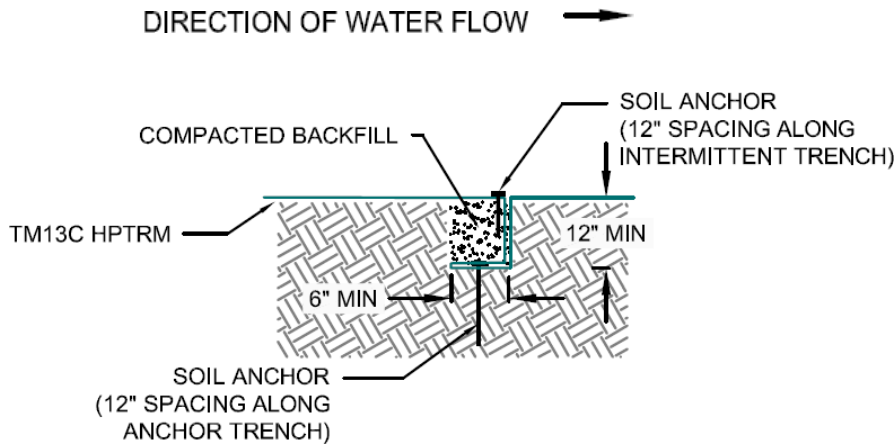

Figure 6: Typical Intermittent Trench

Slope Installation (Mirafi® TM14S or TM13C):

Place the Mirafi® TM14S or TM13C HPTRM mat approx. 5 ft. (1.5 m) over the top of the slope and into an excavated trench measuring at least 12" (30 cm) deep and 12" (30 cm) wide. The excavated trench should be positioned at least 3 ft. (0.9 m) back from the top crest of the slope (Figure 8). Pin the mat at 12" (30 cm) intervals along the bottom of the trench, backfill and compact. Also pin the mat along the top crest of the slope by placing two rows of pins spaced 24" (60.96 cm) apart, every 12" (30 cm) as shown in the detail. Backfill and compact excavated trench.

Unroll the Mirafi® TM14S or TM13C HPTRM mat down the slope while maintaining intimate contact with the soil. When starting installation of an adjacent roll (mat), allow the new mat to shingle-lap over the previously installed roll a minimum of 6" (15 cm). Pin at 12" (30 cm) intervals along the entire overlap (Figure 10).

At the toe of slope, the Mirafi® TM14S or TM13C should be placed into an anchor trench at a depth of 12" (30 cm) with a 6" (15 cm) wide horizontal section allowed for anchoring (Figure 9). Anchor securely with suitable pins at 12" (30 cm) intervals as shown in the detail then backfill and compact the soil.

In addition to anchoring in all terminal trenches and overlaps, The Mirafi® HPTRM should be pinned to the ground in a 3 ft. (0.9 m) center to center pattern (Figure 11). Less frequent stapling/ pinning may be acceptable on small slopes.

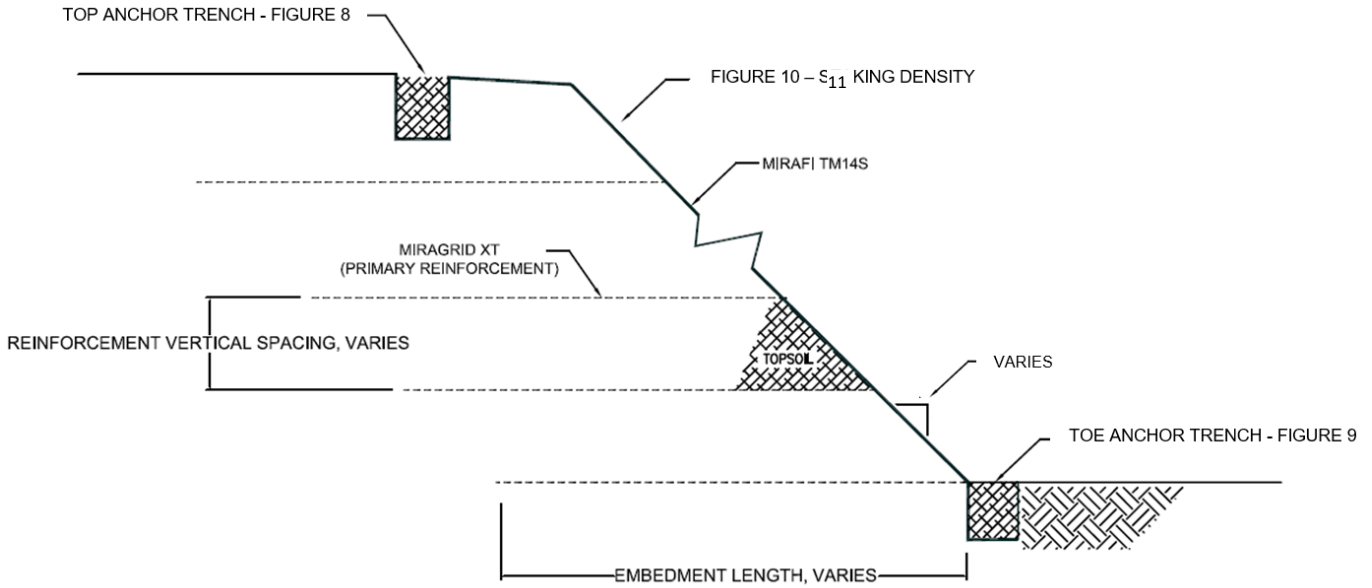

Figure 7: Typical Slope Section with Mirafi® TM14S

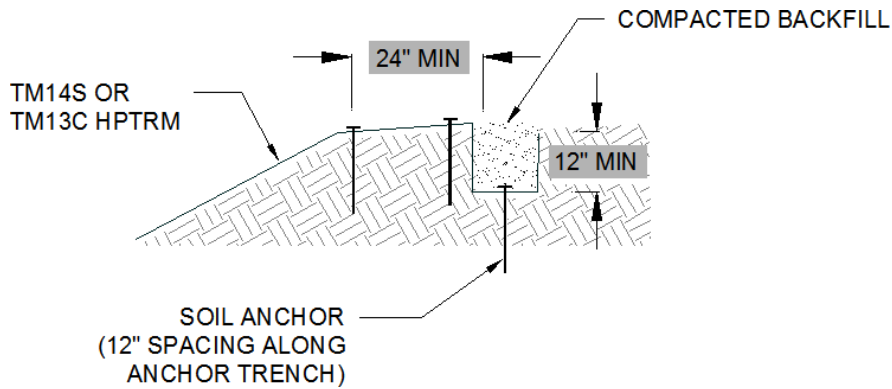

Figure 8: Typical Anchor Trench – Top of Slope

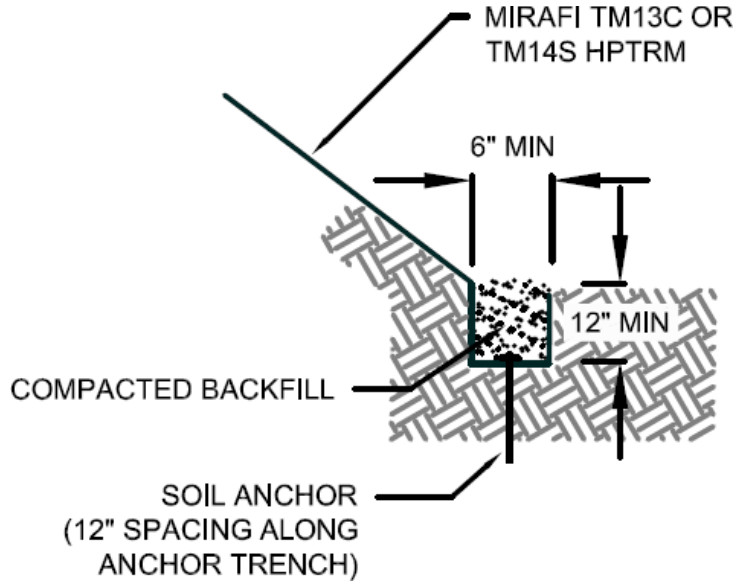

Figure 9: Typical Anchor Trench – Toe of Slope

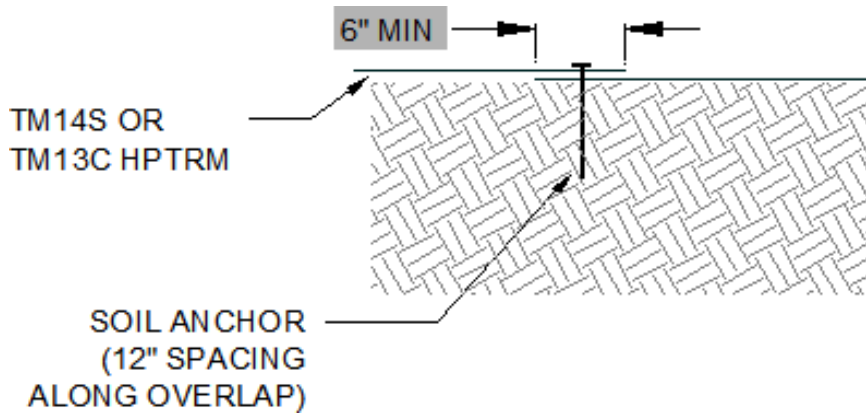

Figure 10: Typical Overlap

Securing Devices:

11 Gauge, 12 in. (30 cm) x 1 in. (2.5 cm) x 12 in. (30 cm) metal staples or 18 in. (45 cm) pins, having 3/16 in. (0.5 cm) shank diameter and an attached 1½ in. (4 cm) dia. washer, are suitable for fastening Mirafi® TM14S or TM13C to the ground. Drive staples or pins so that the top of the staple or washer is flush with ground surface. Staple or pin each mat as outlined in the above sections. Staples and pins should be placed according to the Anchor Placement Density table shown in Figure 9, below.

Note: The appropriate securing device shall be site-specific based upon hydraulic conditions and soil type and shall be identified in the project specifications. Final decision regarding proper installation details shall be written into the project specifications and is the responsibility of the project engineer.

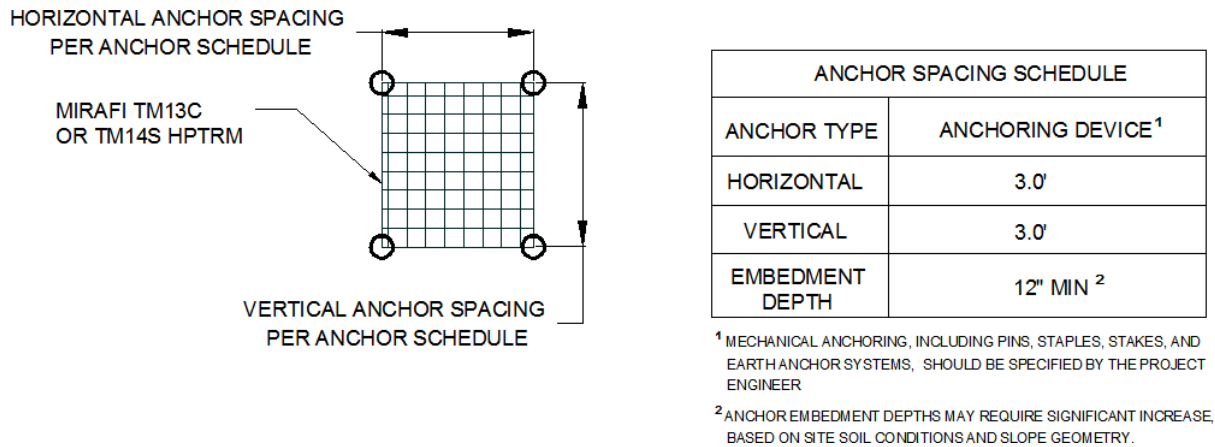

Figure 11: Anchor Placement Density