

# USG COMPÄSSO™ ELITE TRANSITIONS

USG Compässö™ Elite DAS  
Transitions Trim with  
USG Mars™ Acoustical Panels/  
USG Donn® Brand Identitee® DXI™  
Acoustical Suspension System

**TO ORDER SAMPLES, GO TO [USG.COM](http://USG.COM) OR [CGCINC.COM](http://CGCINC.COM)**

Other colors available by special order.

**PAINTED COLORS**



Flat White  
050

**CUSTOM COLORS AVAILABLE**



## FEATURES AND BENEFITS

- USG Compässö™ Elite Transitions are extruded aluminum trims for creating elevation change fascias between differing ceiling planes.
- Easier to install than conventional drywall fascias.
- Available for drywall lower to acoustical upper and acoustical to acoustical ceiling transitions.
- Drywall transition has an integrated taping flange for a clean, finished edge.
- Designed for 5/8" thick gypsum board.
- Compatible with all USG Donn® Brand Suspension Systems and USG Drywall Suspension Systems.
- Works with USG Compässö™ Elite attachment clips and splice plates.

## APPLICATIONS

- Interior Applications
- Wall to Wall Ceilings
- Quick Ship Straights
- New Construction

Acoustical to Acoustical

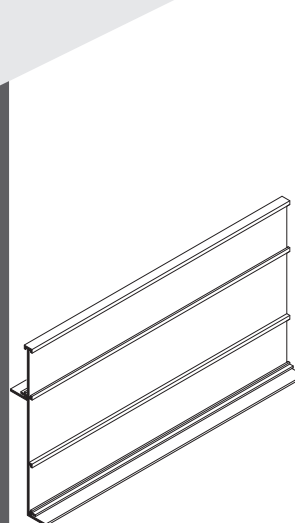

Drywall to Acoustical

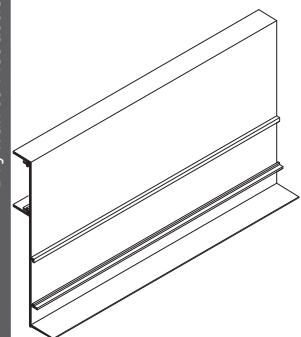

# USG COMPASSO™ ELITE TRANSITIONS

ORDER SAMPLES/LITERATURE  
 USG: usg.com or samplitt@usg.com  
 CGC: contact Sales Representative

TECHNICAL SERVICES  
 800 USG.4YOU (874-4968)

FOR MOST UP-TO-DATE  
 TECHNICAL INFORMATION  
 AND LEED REPORT TOOL  
 usgdesignstudio.com  
 cgcdesignstudio.com

## PRODUCT INFORMATION

## TRIM PROFILES

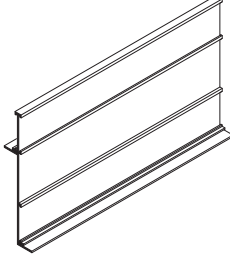
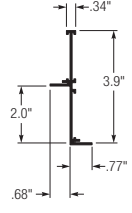
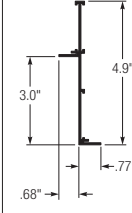
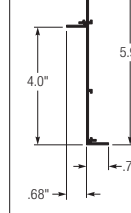
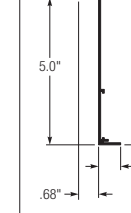
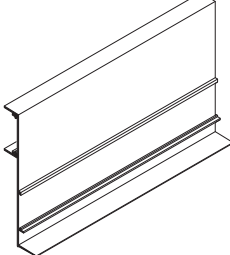
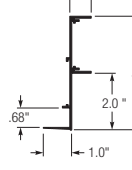
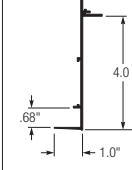
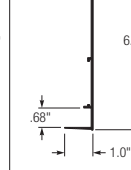
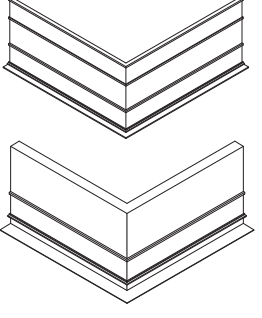
Materials	Length		Finishes		
Extruded aluminum alloy	10 ft.		Factory-applied powder-coated polyester finish		
<b>USG Compasso™ Elite AAS</b> Acoustical to Acoustical	<b>2" - ALSFTACAC210</b>	<b>3" - ALSFTACAC310</b>	<b>4" - ALSFTACAC410</b>	<b>5" - ALSFTACAC510</b>	<b>6" - ALSFTACAC610</b>
					
<b>USG Compasso™ Elite DAS</b> Drywall Lower to Acoustical Upper	<b>2" - ALSFTDWAC210</b>	<b>4" - ALSFTDWAC410</b>	<b>6" - ALSFTDWAC610</b>	Available Factory-Welded Corners	
					

## ATTACHMENT DETAILS

### USG Compasso™ Elite AAS

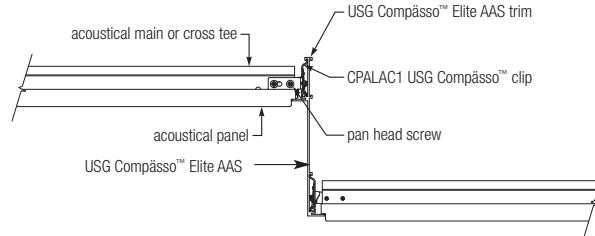

### USG Compasso™ Elite DAS

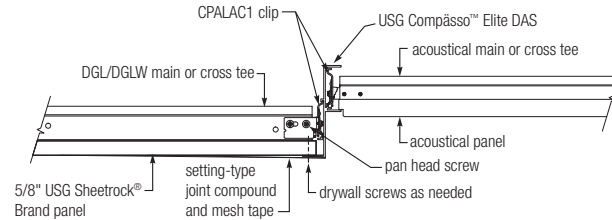

### Important:

Taping flange must be lightly sanded before applying joint compound. For complete installation instructions, refer to *USG Compasso™ Elite Transitions Installation Guide* (IC624).

### Low Emissions (VOC)

CDPH 01350 v1.2-2017 compliance on select finishes, see usg.com for more details and documentation.

## PHYSICAL DATA

### Notice

The information in this document is subject to change without notice. CGC Inc. or USG Corp. assumes no responsibility for any errors that may inadvertently appear in this document.

IC623/rev. 6-22  
 © 2022 USG Corporation and/or its affiliates. All rights reserved. Printed in U.S.A.

### Product literature

Data sheet: IC623  
 Installation guide: IC624  
 Warranty SC2102  
 Care and maintenance instructions: IC518  
 Trim systems design guide

### Online tools

usgdesignstudio.com or cgcdesignstudio.com

### Light Reflectance

Flat White .80 LR

### Material

Extruded aluminum alloy.

Manufactured by USG Interiors, LLC  
 550 West Adams Street  
 Chicago, IL 60661

The trademarks USG, CGC, COMPASSO, DONN, DXI, IDENTITEE, MARS, SHEETROCK, IT'S YOUR WORLD, BUILD IT, the USG/CGC logo, the design elements and colors, and related marks are trademarks of USG Corporation or its affiliates.

Safety First! Follow good safety/industrial hygiene practices during installation. Wear appropriate personal protective equipment. Read SDS and literature before specification and installation.

