

METAL CEILING PANELS
Celebration™ Snap-In and Panz™

SYSTEMS GUIDE



IT'S YOUR WORLD. BUILD IT.®

METAL CEILING PANELS

CELEBRATION™ SNAP-IN AND PANZ™

SYSTEMS GUIDE

HOSPITALITY

ENTERTAINMENT
AND GAMING

OFFICES AND LOBBIES

TRANSPORTATION HUBS

HEALTHCARE

Celebration™ Snap-In and Panz™ metal panels impart a cool, sophisticated aesthetic to enhance the ambience of your space without compromising the need for ceiling access. Choose from a variety of finishes, colors and texture options to create a look that's simple and serene or striking and bold.

Celebration™ Snap-In panels snap up into the reveal of the USG DONN® Brand Fineline® suspension system, concealing the grid for a clean, monolithic appearance while allowing full access to the plenum above. Panz™ panels lay into Donn® Brand Centricitee™, DXI, DX®/DXL™ and Fineline suspension systems to create a sleek, modern style with easy, traditional ceiling access.

Understand Your System

4

CELEBRATION™ SNAP-IN OVERVIEW

Celebration™ Snap-In Components and Applications
Panz™ Overview
Panz™ Components and Applications

Celebration™

5

CELEBRATION™ SNAP-IN PANELS

Snap up to conceal the suspension system
Components
Applications

Panz™

10

PANZ™ PANELS

Lay in for traditional plenum access
Components
Applications

Specify Your System

15

DESIGN TOOLS

Finishes
Perforations and Embossing

For More Information

Technical Service: 800.USG.4YOU
Website: usg.com

SYSTEM OVERVIEW

PANELS

Celebration™ Snap-In panels – Snap-up, suspension-hiding panels feature snap-up installation and provide easy downward access, making them great for shallow-plenum areas. Panels are available in a range of finishes, painted colors and perforation patterns.

Panz™ panels – Lay in just like traditional acoustical panels. Available in many finishes, painted colors and perforation patterns as well as Diamondflex™ expanded metal.

SIZES²

Celebration™ Snap-In and Panz™ panels are available in traditional square and rectangular sizes as well as new large format plank sizes. Module sizes include:

1' x 4'	2' x 2'	30" x 30"
1' x 5'	2' x 4'	30" x 60"
20" x 60"	2' x 6'	4' x 4'
	2' x 8'	

Note: Panels also available in Metric module sizes.

SUSPENSION SYSTEMS

Celebration™ Snap-In panels snap up into the reveal of the Fineline® DXF suspension system. Panels may be field-cut at walls and columns but otherwise should be used in full modules.

Panz™ panels available with the same edge details as USG acoustical ceiling panels, Panz™ panels install into narrow-profile and standard suspension systems. Panels feature a unique trim detail that ensures a clean reveal edge on field-cut panels.

PERIMETER DETAILS

Optional Compäso™ trim may be used with Celebration™ Snap-In and Panz™ ceilings for a finished appearance at exposed edges. See Compäso Trim Systems Design Guide IC400 for more information.

ACOUSTICAL PERFORMANCE

Perforated Celebration™ Snap-In and Panz™ panels with Acoustibond™ backer achieve NRC .65¹ when installed in an enclosed plenum (16" depth min.). Available fiberglass polybag infill provides even greater acoustical performance. Celebration™ Snap-In panels in Sarante® available with perforation holes 1/16" diameter min.

Note

1. Tested with CD06305 (A062) perforation pattern.
2. Celebration™ Snap-In panels in Sarante® available in up to 2' wide and up to 6' long only.

CELEBRATION™ SNAP-IN PANELS

Snap up to conceal the suspension system

SUSPENSION-HIDING

Celebration™ Snap-In panels snap up into the 1/4"-reveal Finline® DXF suspension system, achieving the clean, monolithic aesthetic required in the design of contemporary spaces.

TYPICAL MODULE SIZES²

1' x 4'	2' x 2'	30" x 30"
1' x 5'	2' x 4'	30" x 60"
20" x 60"	2' x 6'	4' x 4'
	2' x 8'	

Additional panel sizes available on request.

Note: The following panel sizes should be installed with a denser grid layout as follows.

4' x 4' panels	2' x 4' grid
2' x 8' panels	2' x 4' grid
30" x 60" panels	30" x 30" grid

MATERIALS

Panels: Aluminum
 Finline® DXF suspension system: Cold-rolled steel
 Compäso™ edge trim: Cold-rolled steel (10" & 12" Compäso™ Standard in Aluminum)

FINISHES¹

4 anodized metals;
 Standard and Advantage colors, plus metallic and custom paint colors;
 9 Timbre™ finishes;
 3 standard Sarante® finishes.

PERFORATIONS

Available in solid metal or 24 perforation patterns and four embossed patterns. Black Acoustibond™ sound backer included standard with perforated panels unless specified; backer also available in white. Celebration™ Snap-In panels in Sarante® available with perforation holes 1/16" diameter min.

PLENUM DEPTH

Because panels are installed from below, the clearance for installation and removal of panels is minimal. Additional plenum clearance of up to 9" is required for air-boot and lighting installations, depending on the unit selected. Acoustical performance shown on page 6 for perforated panels with Acoustibond sound backer requires an enclosed plenum with minimum 18" depth.

EXTERIOR APPLICATIONS

For exterior application details, refer to the USG Exterior Ceilings Installation Guide (SC3212) and the USG Exterior Ceilings Application Guide (SC2561).

ASSEMBLY

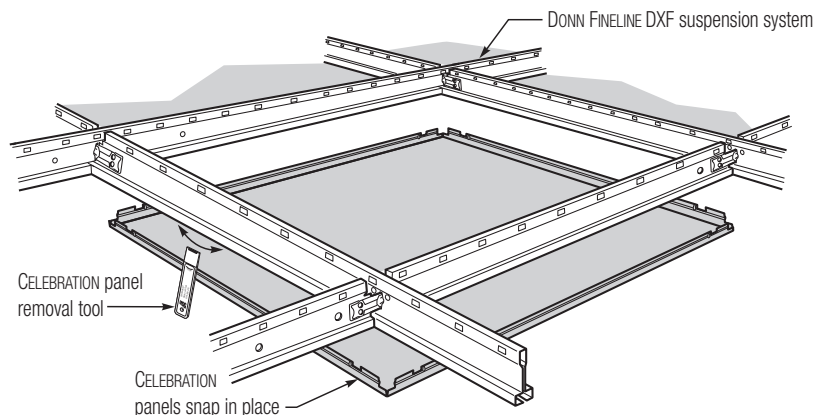

Notes

1. See the Metal Finishes selector SC2954 or Ceiling Systems Desktop Reference (SC2000) for more information.
2. Celebration™ Snap-In panels in Sarante® available in up to 2' wide and up to 6' long.

CELEBRATION™ SNAP-IN PANELS

Components

SHAPE

Panel Options

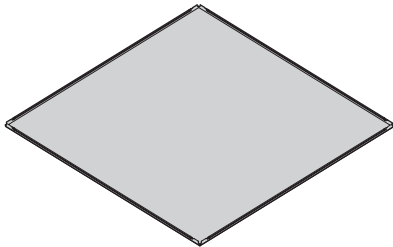
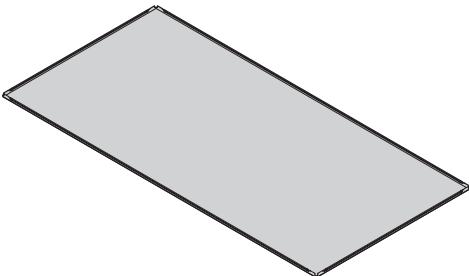
Square	Rectangular
Sizes: 2'x 2', 30" x 30" and 4'x 4'	Sizes: 1'x 4', 1'x 5', 20" x 60", 2'x 4', 2'x 6', 2'x 8' and 30" x 60"
	

FINISH

Celebration™ Snap-In panels are offered in up to seven distinctive finishes: anodized metal, brushed metal, polished metal, painted metal and Sarante®¹. See page 15 for details and availability by panel size.

TEXTURE

Panels are available in solid metal or a choice of 24 perforated patterns. 2'x2' panels may also be embossed, with or without perforation. See pages 16-22 for details.

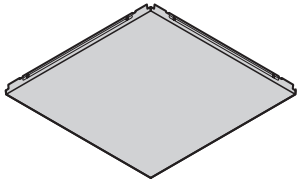
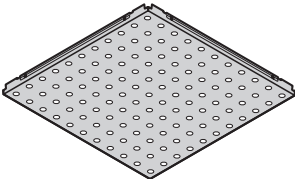
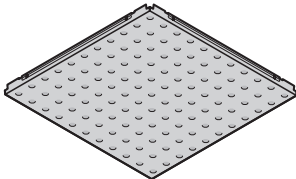
Solid panel	Perforated panel	Embossed panel
		

Note

1. Celebration™ Snap-In panels available in three standard Sarante® colors.

CELEBRATION™ SNAP-IN PANELS

Components

Perforated Celebration™ Snap-In panels come standard with a black, factory-applied Acoustibond™ backer for enhanced sound performance. The Acoustibond™ backer is included on all perforated panels unless otherwise specified. This backer is also available in white. For even greater acoustical performance, fiberglass backing is available.

Panel	Optional Acoustical Material	Sound Rating - NRC ¹	
		Perforation CD06305NB (A062)	Perforation CD11717 (A116)
Perforated panel	Acoustibond backer	.65	.70
Perforated panel	2", .75 lb. fiberglass in poly bag	.85	.90

Note

1. Enclosed plenum with minimum 16" depth.

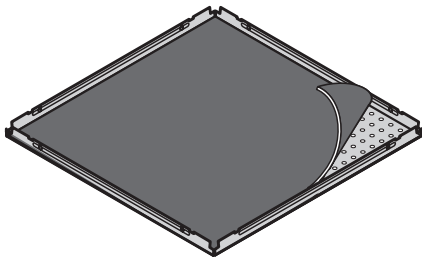
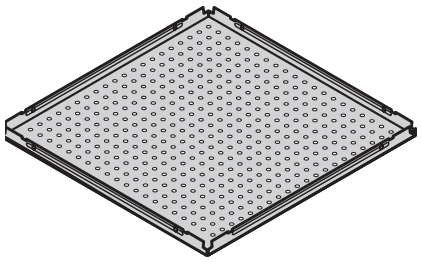
Standard (with black Acoustibond™ backer)	Optional (without Acoustibond™ backer)
	

Celebration™ Snap-In panels snap up into the reveal of the Fineline® DXF suspension system, concealing the grid for a clean, monolithic appearance, while allowing full access to the plenum above.

Panels may be field cut at walls and columns but otherwise should be used in full modules.

EDGE DETAIL

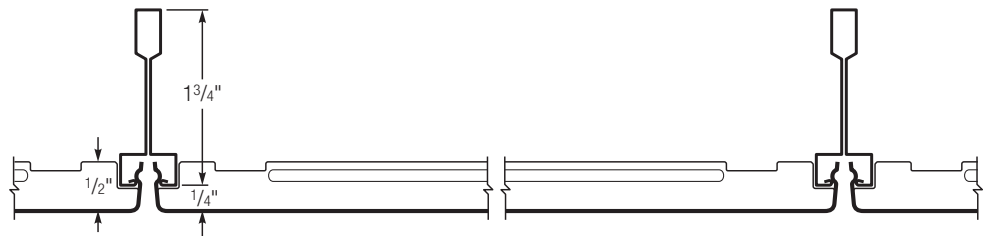

ACOUSTICAL PERFORMANCE

HIDDEN SUSPENSION SYSTEM

CELEBRATION™ SNAP-IN PANELS

Applications

PERIMETER DETAILS

Wall DXF U2-3/32

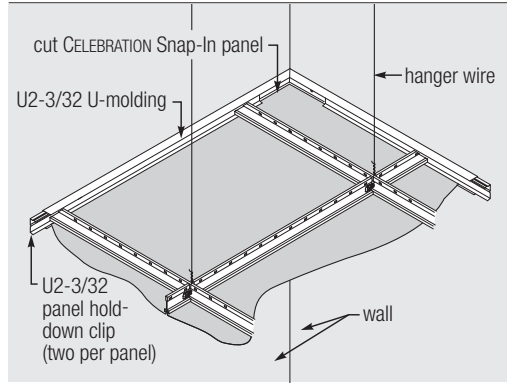

Column-Square

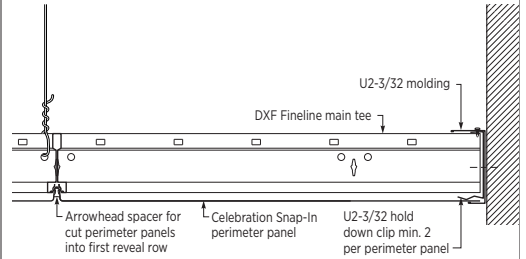
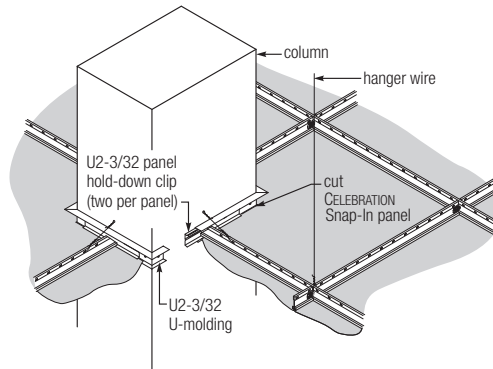

Column-Round

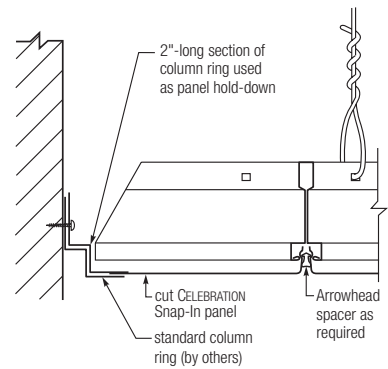
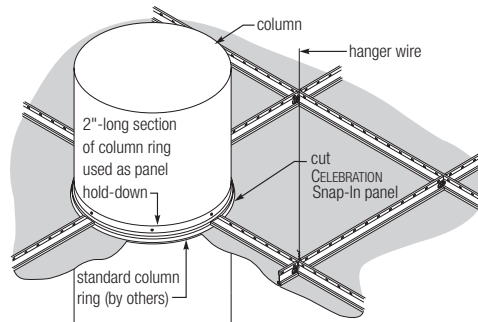





CELEBRATION™ SNAP-IN PANELS

Applications

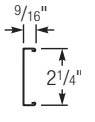
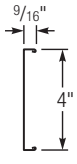
TRIM DETAILS

Optional Compasso™ edge trim in 2-1/4", 4", 6", 8", 10" and 12" heights may be added for a finished appearance at exposed edges.

2-1/4"	4"	6"	8"	10"	12"
 <p>(on module only)</p>					

Parallel (On Module)

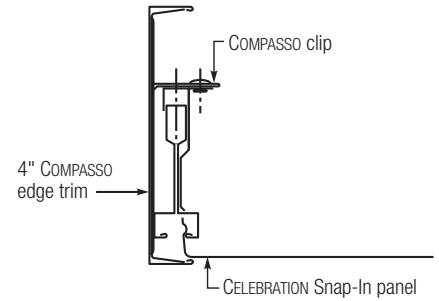
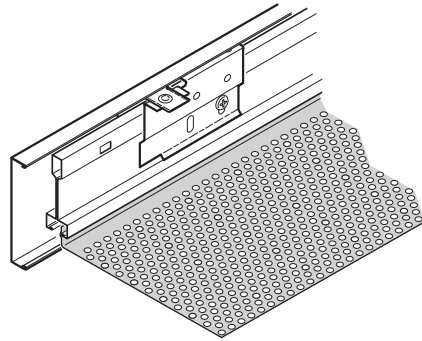

Perpendicular (Off Module)

2-1/4" trim may not be used in off-module applications

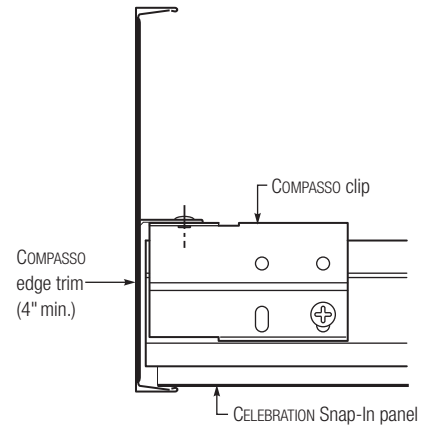
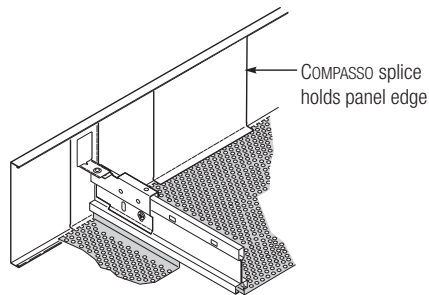

PANZ™ PANELS

Lay in for traditional plenum access

LAY-IN PANELS

Panz™ panels combine the easy plenum access of traditional acoustical panels with the sleek, contemporary style of metal.

MATERIALS

Panels: Aluminum

Donn® Brand suspension systems: Cold-rolled steel

Compasso™ edge trim: Cold-rolled steel (10" & 12" Compasso™ Standard in Aluminum)

FINISHES¹

4 anodized metals;

4 Diamondflex™ expanded metals;

Standard and Advantage colors, plus metallic and custom paint colors;

9 Timbre™ finishes.

TEXTURES

Available in solid metal, 24 perforation patterns and four embossed patterns. Black Acoustibond™ backer included standard with perforated panels unless specified; backer also available in white.²

ASSEMBLY

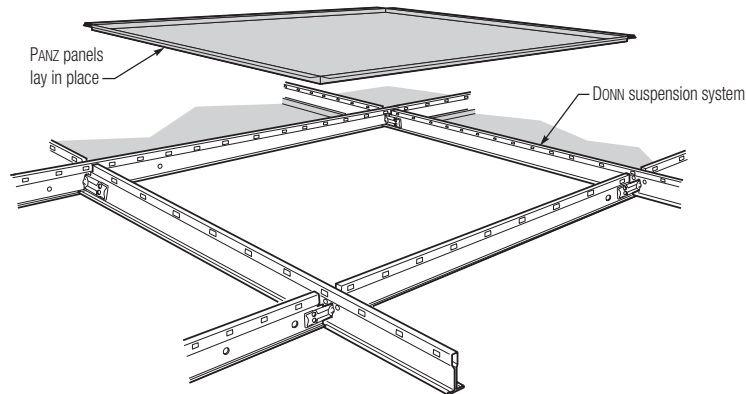

Note

1. See the Metal Finishes selector SC2954 and Ceilings Catalogue SC2000 for more information.

2. Acoustibond backer not available with Diamondflex™ panels.

PANZ™ PANELS

Components

SHAPE

Panel Options

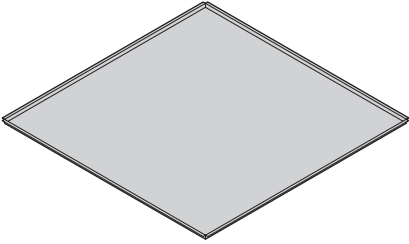
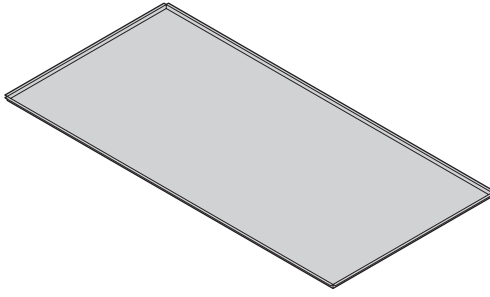
Square	Rectangular
Sizes: 2'x 2', 30" x 30" and 4'x 4'	Sizes: 1'x 4', 1'x 5', 20" x 60", 2'x 4', 2'x 6', 2'x 8' and 30" x 60"
	

FINISH

Panz™ panels are offered in up to seven distinctive finishes: anodized metal, brushed metal, polished metal, painted metal and Diamondflex™ expanded metal. See page 17 for details and availability by panel size.

TEXTURE

Panels are available in solid metal or a choice of perforated patterns. 2'x 2' panels may also be embossed, with or without perforation. See pages 16-22 for details.

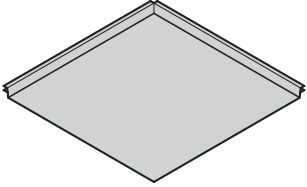
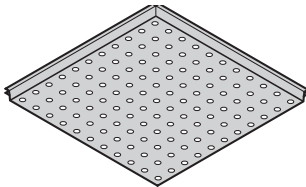
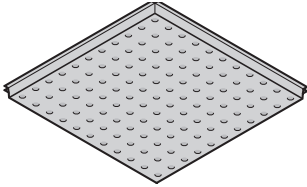
Solid panel	Perforated panel	Embossed panel
		

PANZ™ PANELS

Components

ACOUSTICAL PERFORMANCE

Perforated Panz™ panels come standard with a black, factory-applied Acoustibond™ backer for enhanced sound performance. The Acoustibond™ backer is included on all perforated panels unless otherwise specified. This backer is also available in white. For even greater acoustical performance, fiberglass backing is available.¹

Panel	Optional Acoustical Material	Sound Rating - NRC ²	
		Perforation CD06305NB (A062)	Perforation CD11717 (A116)
Perforated panel	Acoustibond™ backer	.65	.70
Perforated panel	2", .75 lb. fiberglass in poly bag	.85	.90

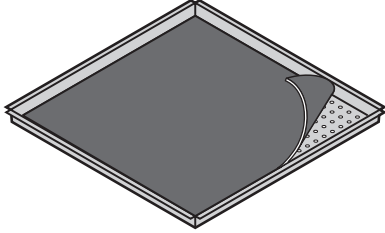
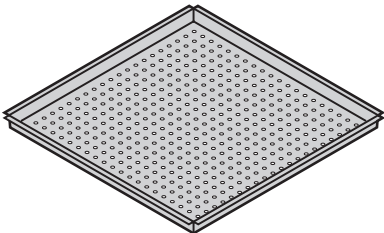
Standard (with black Acoustibond™ backer)	Optional (without Acoustibond™ backer)
	

SUSPENSION SYSTEMS

Available with the same edge details as USG acoustical ceiling panels, Panz™ panels install into narrow-profile and standard Donn® suspension systems.

EDGE DETAIL

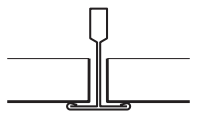
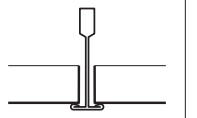
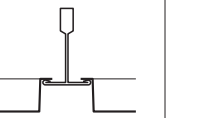
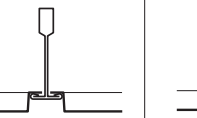
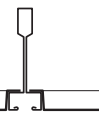
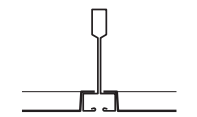
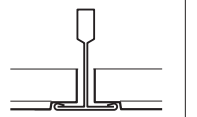
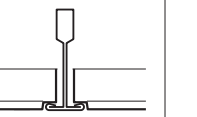
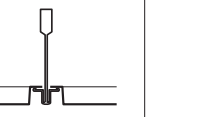
USG Square Edge with 15/16" USG DX® Suspension	USG Square Edge with 9/16" USG Centricitee™ DXT™ Suspension	USG Shadowline Edge with 15/16" USG DX® Suspension	USG Finline® Edge with 9/16" USG Centricitee™ DXT™ Suspension	USG Finline® Edge with 9/16" USG Finline® DXF™ Suspension
				
USG Finline® Edge with 9/16" USG Finline® 1/8 DXFF™ Suspension	USG Flush Mount Edge with USG DX® Suspension ⁵ (FM 15)	USG Flush Mount Edge with USG DXT™ Suspension ⁴ (FM 9)	USG Finline® Edge with USG Identitee® DXI™ Suspension	
				

Notes:

1. Acoustibond™ backer not available with Diamondflex™ panels.
2. Enclosed plenum with minimum 18" depth.
3. White Acoustibond™ backer available.
4. Only available in 2' x 2' panels.
5. Flush Mount Edge with DX® grid available up to 2' x 4' panels.

PANZ™ PANELS

Applications

PERIMETER DETAILS

Non-Wall or Floating Condition

DX® or DXT™ Profile

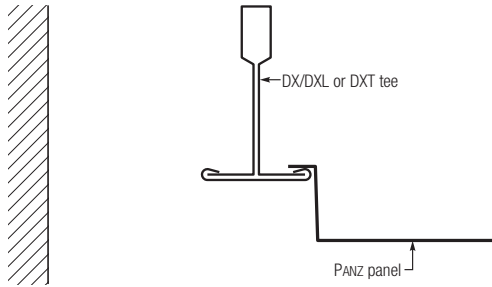

DXF™ or DXFF™ Profile

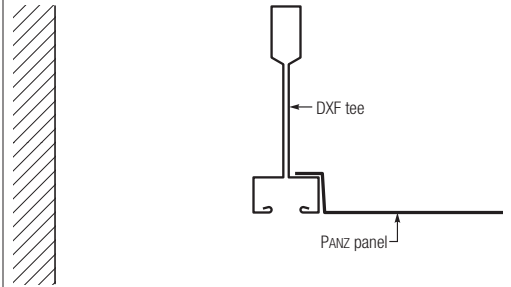

Wall/Column DX®/DXL™ M9

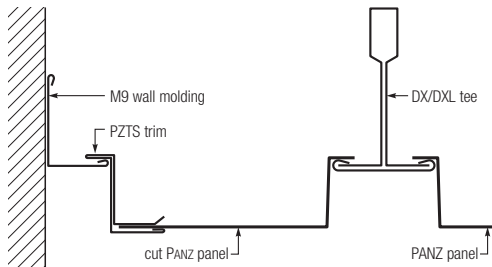

Wall/Column DXF™ UA25

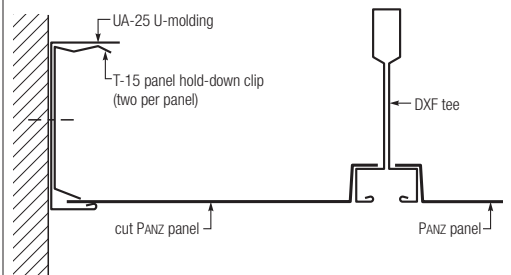

Wall/Column DX®/DXL™-DXT™ U25 clip

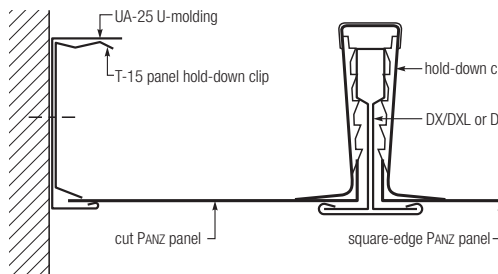

Wall/Column DXT™ M9

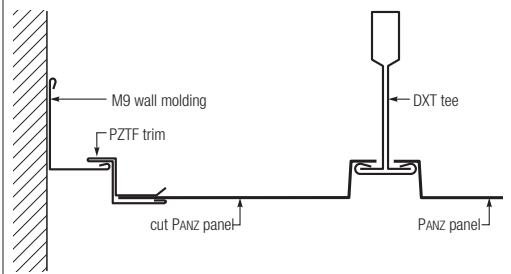



PANZ™ PANELS

Applications

TRIM DETAILS

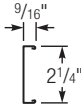
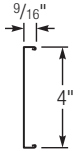
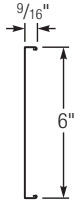
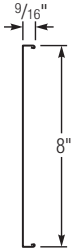
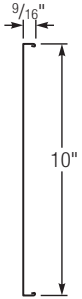
Optional Compasso™ edge trim in 2-1/4", 4", 6", 8", 10" and 12" heights may be added for a finished appearance at exposed edges.

2-1/4"	4"	6"	8"	10"	12"
					

Parallel (On Module)

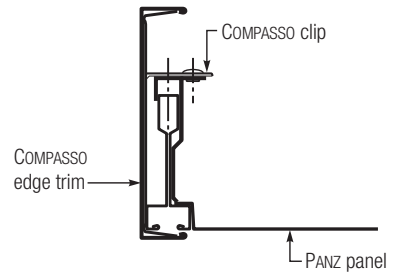
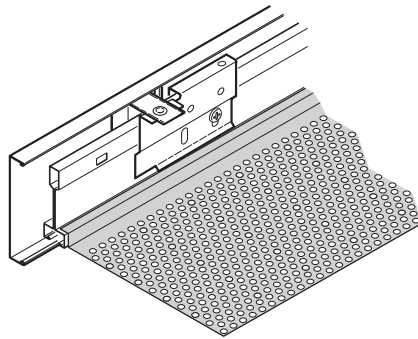



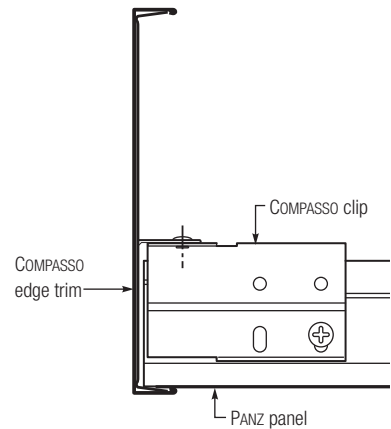
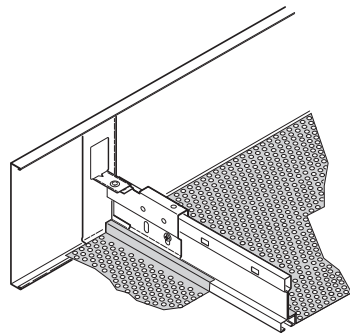







Perpendicular (Off Module)



CELEBRATION™ SNAP-IN AND PANZ™ PANELS

Finishes

AVAILABILITY	Panel Size ¹									
	2' x 2'	30" x 30"	4' x 4'	1' x 4'	1' x 5'	20" x 60"	2' x 4'	2' x 6'	2' x 8'	30" x 60"
										
Anodized Metals	•									
Painted Metals										
Flat White	•	•	•	•	•	•	•	•	•	•
Silver Satin	•	•	•	•	•	•	•	•	•	•
Metallic Copper ³	•			•	•	•	•	•		
Metallic Gold ³	•			•	•	•	•	•		
Metallic Oyster ³	•			•	•	•	•	•		
Custom Color	•	•	•	•	•	•	•	•	•	•
Diamondflex™ Expanded Metals²	•									
Timbre³										
Maple (4010)	•			•	•	•	•	•		
VG Fir (4011)	•			•	•	•	•	•		
Red Birch (4012)	•			•	•	•	•	•		
Golden Oak (4198)	•			•	•	•	•	•		
Walnut (4014)	•			•	•	•	•	•		
Roasted Chestnut (4197)	•			•	•	•	•	•		
Cherry (4013)	•			•	•	•	•	•		
Mahogany (4015)	•			•	•	•	•	•		
Driftwood (4199)	•			•	•	•	•	•		
Sarante⁴										
Oak Line (S-22)	•			•	•	•	•	•		
Blond Pear (S-15)	•			•	•	•	•	•		
Dark Jatoba (S-37)	•			•	•	•	•	•		

Notes

1. Custom sizes available. Contact your local USG representative for details.
2. 2' x 2' Panz™ panels only; available with FL, SL and Square edge.
3. Available in 2' wide panels up to 6' long only.
4. Celebration™ Snap-In panels in Sarante® available in up to 2' wide and in up to 6' long only.

CELEBRATION™ SNAP-IN AND PANZ™ PANELS

Perforations and Embossing

AVAILABILITY











Perforation Patterns

- CD06305NB (A062)
- CD11717 (A116)
- CD18803 (A188)
- CD25039 (A250)
- CD50055 (A500)
- CEO7906 (B079)
- CE12510 (B125)
- CE18833 (B188A)
- CE19735 (B197)
- CE25030 (B250)
- CE25058 (B250H)
(FORMERLY H250)
- CE31246 (B312)
- CE50063 (B500)
- CS06302 (C062)
- CS06310 (C062A)
- CS11708 (C116)
- CS18801 (C188)
- CS25012 (C250A)
- CS37509 (C375)
- CS50009 (C500)
- CE25030 (D250)
- SS37511 (D375)
- SS50011 (D500)
- SS50070 (D500D)

Embossing Patterns

- EC25D
- EC25U
- EM25D
- EM25U

Panel Size

	2' x 2'	30" x 30"	4' x 4'	1' x 4'	1' x 5'	20" x 60"	2' x 4'	2' x 6'	2' x 8'	30" x 60"
										
CD06305NB (A062)	•	•	•	•	•	•	•	•	•	•
CD11717 (A116)	•	•	•	•	•	•	•	•	•	•
CD18803 (A188)	•	•	•	•	•	•	•	•	•	•
CD25039 (A250)	•	•		•	•	•	•	•		•
CD50055 (A500)	•	•		•	•	•	•	•		
CEO7906 (B079)	•	•	•	•	•	•	•	•	•	•
CE12510 (B125)	•	•	•	•	•	•	•	•	•	•
CE18833 (B188A)	•	•		•	•	•	•	•		•
CE19735 (B197)	•	•		•	•	•	•	•		•
CE25030 (B250)	•	•		•	•	•	•	•		•
CE25058 (B250H) (FORMERLY H250)	•	•		•	•	•	•	•		•
CE31246 (B312)	•	•		•	•	•	•	•		•
CE50063 (B500)	•	•		•	•					
CS06302 (C062)	•	•	•	•	•	•	•	•	•	•
CS06310 (C062A)	•	•	•	•	•	•	•	•	•	•
CS11708 (C116)	•	•	•	•	•	•	•	•	•	•
CS18801 (C188)	•	•	•	•	•	•	•	•	•	•
CS25012 (C250A)	•	•		•	•	•	•	•		•
CS37509 (C375)	•	•	•	•	•	•	•	•	•	•
CS50009 (C500)	•	•	•	•	•	•	•	•	•	•
CE25030 (D250)	•	•		•	•	•	•	•		•
SS37511 (D375)	•	•	•							
SS50011 (D500)	•	•		•	•	•	•	•		•
SS50070 (D500D)	•	•		•	•	•	•	•		•
EC25D	•									
EC25U	•									
EM25D	•									
EM25U	•									

CELEBRATION™ SNAP-IN AND PANZ™ PANELS

Perforations

- Perforation patterns shown at 50% of actual size.
- When ordering, please refer to the pattern number for perforation samples (for example, "A062").
- See page 16 for availability.

**ROUND HOLES
AT 45° ALIGNMENT**

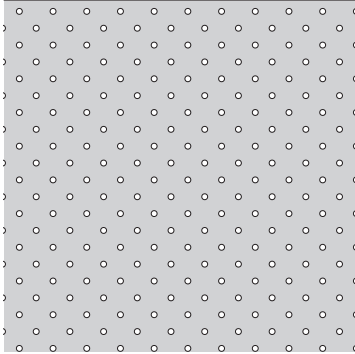
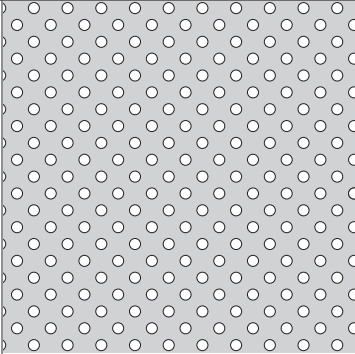
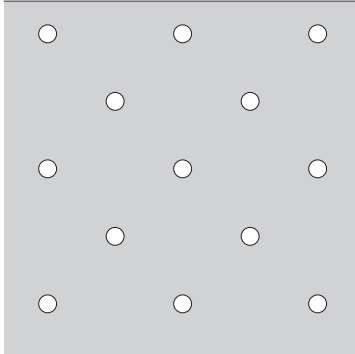
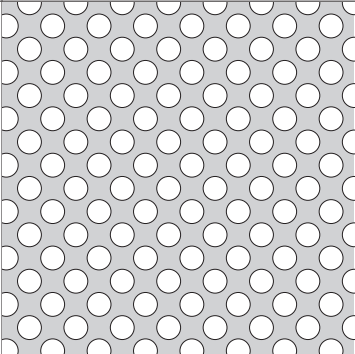
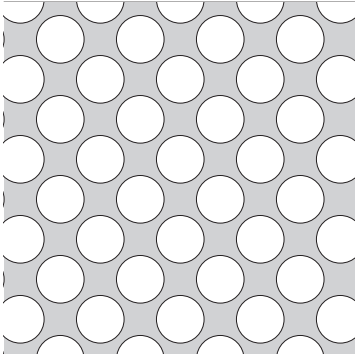
<p>Pattern CD06305NB (A062)</p>  <p>Round - 1/16" perforations .25" o.c., 5% open area</p>	<p>Pattern CD11717 (A116)</p>  <p>Round - 15/128" perforations .354" o.c., 17% open area</p>
<p>Pattern CD18803 (A188)</p>  <p>Round - 3/16" perforations 1" o.c., 3% open area</p>	<p>Pattern CD25039 (A250)</p>  <p>Round - 1/4" perforations .5" o.c., 39% open area</p>
<p>Pattern CD50055 (A500)</p>  <p>Round - 1/2" perforations .848" o.c., 55% open area Not to be used with the One-Directional Curvatura™ System</p>	

CELEBRATION™ SNAP-IN AND PANZ™ PANELS

Perforations

- Perforation patterns shown at 50% of actual size.
- When ordering, please refer to the pattern number for perforation samples (for example, "A062").
- See page 16 for availability.

ROUND HOLES
AT 60° ALIGNMENT

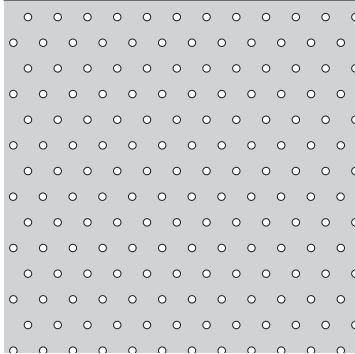
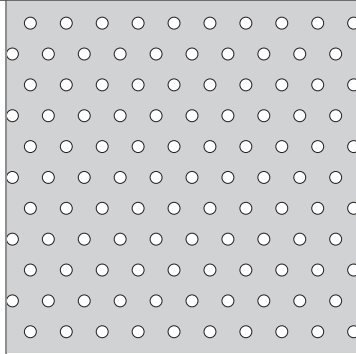
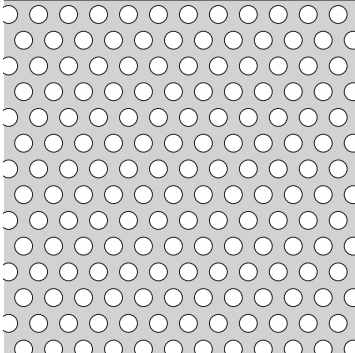
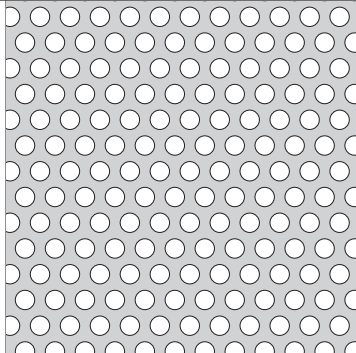
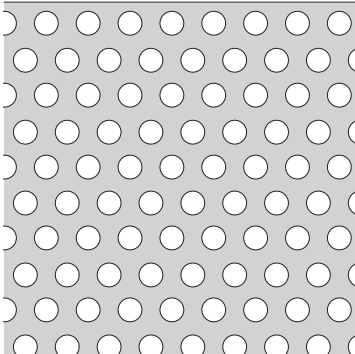
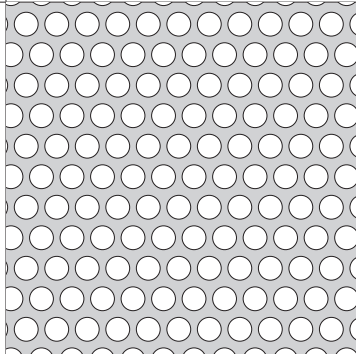
<p>Pattern CE07906 (B079)</p>  <p>Round - 5/64" perforations .312" o.c., 6% open area</p>	<p>Pattern CE12510 (B125)</p>  <p>Round - 1/8" perforations .375" o.c., 10% open area</p>
<p>Pattern CE18833 (B188A)</p>  <p>Round - 3/16" perforations .312" o.c., 33% open area</p>	<p>Pattern CE19735 (B197)</p>  <p>Round - 13/64" perforations .316" o.c., 35% open area</p>
<p>Pattern CE25030 (B250)</p>  <p>Round - 1/4" perforations .437" o.c., 30% open area</p>	<p>Pattern CE25058 (B250H) (formerly H250)</p>  <p>Round - 1/4" perforations .32" o.c., 58% open area</p>

CELEBRATION™ SNAP-IN AND PANZ™ PANELS

Perforations

- Perforation patterns shown at 50% of actual size.
- When ordering, please refer to the pattern number for perforation samples (for example, "A062").
- See page 16 for availability.

ROUND HOLES
AT 60° ALIGNMENT

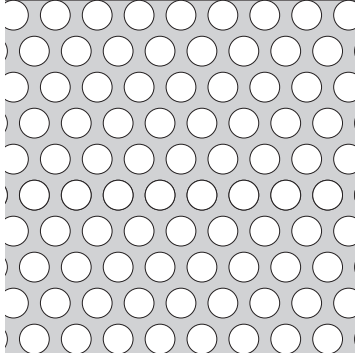
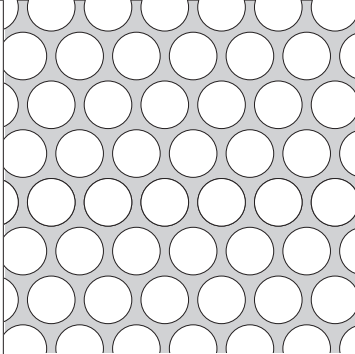
<p>Pattern CE31246 (B312)</p>  <p>Round - 5/16" perforations .437" o.c., 46% open area</p>	<p>Pattern CE50063 (B500)</p>  <p>Round - 1/2" perforations .600" o.c., 63% open area Not to be used with the One-Directional Curvatura™ System</p>
--	---

ROUND HOLES
AT 90° ALIGNMENT

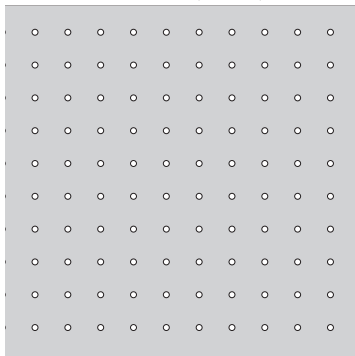
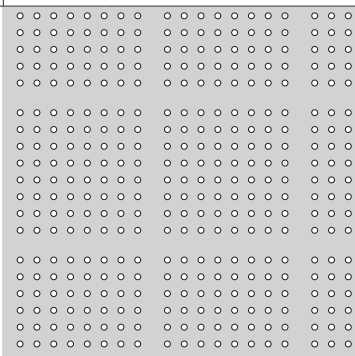
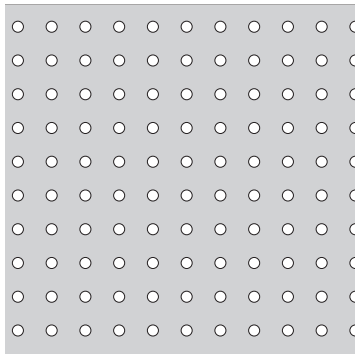
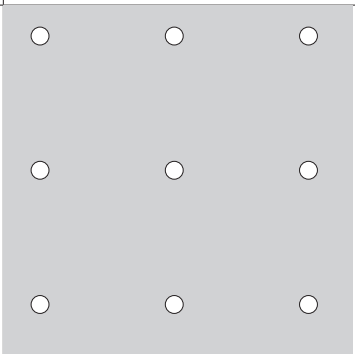
<p>Pattern CS06302 (C062)</p>  <p>Round - 1/16" perforations .351" o.c., 2% open area</p>	<p>Pattern (C062A)</p>  <p>Round - 1/16" perforations .175" o.c., 10% open area</p>
<p>Pattern CS11708 (C116)</p>  <p>Round - 15/128" perforations .344" o.c., 8% open area</p>	<p>Pattern CS18801 (C188)</p>  <p>Round - 3/16" perforations 1.414" o.c., 1% open area</p>

CELEBRATION™ SNAP-IN AND PANZ™ PANELS

Perforations

- Perforation patterns shown at 50% of actual size.
- When ordering, please refer to the pattern number for perforation samples (for example, "A062").
- See page 16 for availability.

ROUND HOLES
AT 90° ALIGNMENT

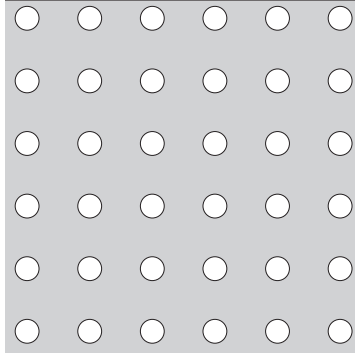
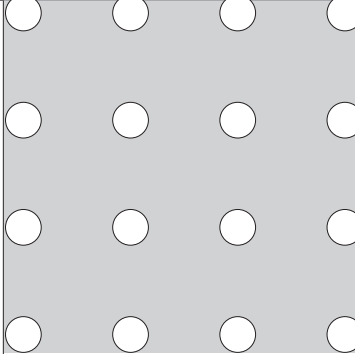
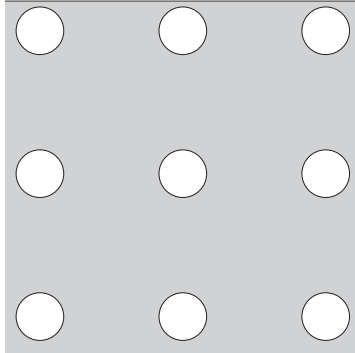
Pattern CS25012 (C250A)	Pattern CS37509 (C375)
 <p data-bbox="521 804 755 856">Round - 1/4" perforations .65" o.c., 12% open area</p>	 <p data-bbox="1036 804 1284 856">Round - 3/8" perforations 1.125" o.c., 9% open area</p>
Pattern CS50009 (C500)	
 <p data-bbox="521 1295 755 1348">Round - 1/2" perforations 1.5" o.c., 9% open area</p>	

CELEBRATION™ SNAP-IN AND PANZ™ PANELS

Perforations

- Perforation patterns shown at 50% of actual size.
- When ordering, please refer to the pattern number for perforation samples (for example, "A062").
- See page 16 for availability.

**SQUARE HOLES
AT 90° ALIGNMENT**

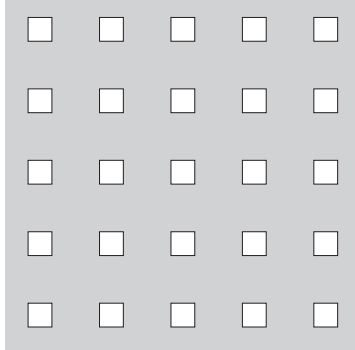
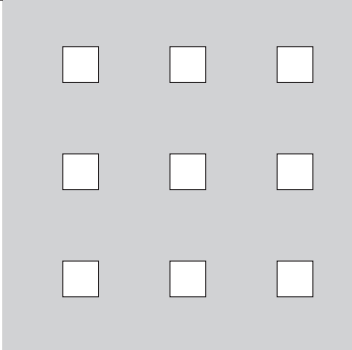
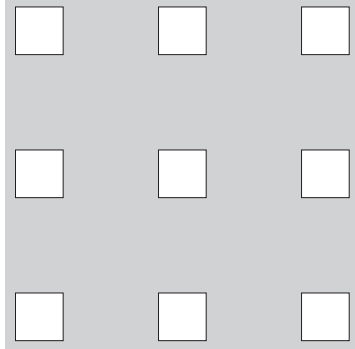
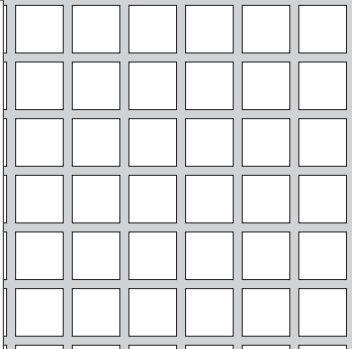
Pattern SS25011 (D250)	Pattern SS37511 (D375)
 <p data-bbox="521 804 760 856">Square - 1/4" perforations .75" o.c., 11% open area</p>	 <p data-bbox="1036 804 1291 856">Square - 3/8" perforations 1.125" o.c., 11% open area</p>
Pattern SS50011 (D500)	Pattern SS50070 (D500D)
 <p data-bbox="521 1295 760 1348">Round - 1/2" perforations 1.5" o.c., 17% open area</p>	 <p data-bbox="1036 1295 1347 1373">Square - 1/2" perforations .595" o.c., 70% open area Meets NFPA for sprinklers above.</p>







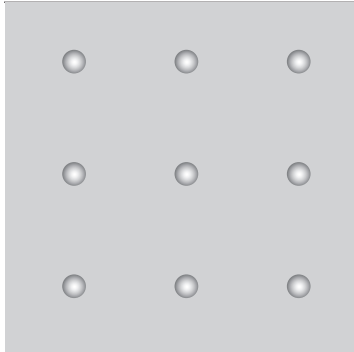

CELEBRATION™ SNAP-IN AND PANZ™ PANELS

Embossing

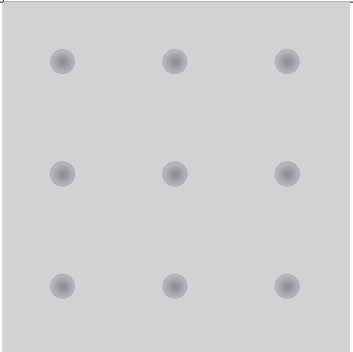
(Available for 2' x 2' Celebration™ Snap-In and Panz™ panels)

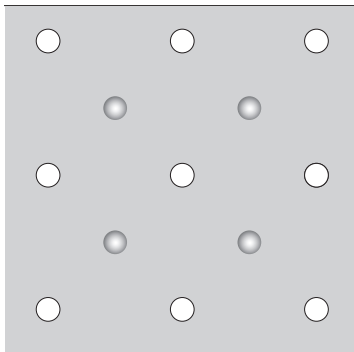
- Embossing patterns shown at 50% of actual size.
- When ordering, please refer to the pattern number (for example, "EM25U").
- See page 16 for availability.

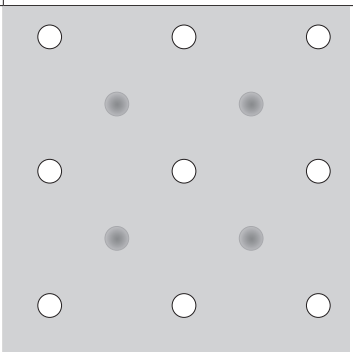
EMBOSSING ONLY

Pattern EM25O	Pattern EM25U
 <p data-bbox="522 804 846 856">Round - 1/4" dia. x 1/16" embossing 1.18" o.c., no perforation</p> <p data-bbox="522 869 899 894">Face side </p>	 <p data-bbox="1045 804 1369 856">Round - 1/4" dia. x 1/16" embossing 1.18" o.c., no perforation</p> <p data-bbox="1045 869 1432 894">Face side </p>
Pattern EC25D	Pattern EC25U
 <p data-bbox="522 1329 862 1413">Round - 1/4" perforations 1.41" o.c., 2% open area Black Acoustibond™ backer standard</p> <p data-bbox="522 1425 889 1451">Face side </p>	 <p data-bbox="1045 1329 1369 1413">Round - 1/4" perforations 1.41" o.c., 2% open area Acoustibond™ backer not available</p> <p data-bbox="1045 1425 1419 1451">Face side </p>

EMBOSSING
AND PERFORATIONS



Rendering
© USG Interiors, LLC 2025.
All rights reserved.

WEBSITES

usg.com

TECHNICAL SERVICE

800 USG.4YOU (847-4968)

SAMPLES/LITERATURE

SAMPLIT@USG.COM

866 528-7089

CUSTOMER SERVICE

800 950.3839

IC415/rev 12-25

© 2025, USG Corporation or its affiliates.
All rights reserved.

Notice

The information in this document is subject to change without notice. CGC Inc. or USG Corp. assumes no responsibility for any errors that may inadvertently appear in this document.

Manufactured by
USG Interiors, LLC
550 West Adams Street
Chicago, IL 60661

Product Information

See usg.com for the most up-to-date product information.

Note

All products described here may not be available in all geographic markets. Consult your local sales office or representative for information.

Trademarks

The trademarks USG, CGC, ACOUSTIBOND, CELEBRATION, CENTRICITEE, COMPASSO, CURVATURA, DIAMONDFLEX, DONN, DX, DXF, DXFF, DXI, DXL, DXT, FINELINE, IDENITEE, PANZ, TIMBRE, IT'S YOUR WORLD. BUILD IT., the USG/CGC logo, the design elements and colors, and related marks are trademarks of USG Corporation or its affiliates.

Notice

We shall not be liable for incidental and consequential damages, directly or indirectly sustained, nor for any loss caused by application of these goods not in accordance with current printed instructions or for other than the intended use. Our liability is expressly limited to replacement of defective goods. Any claim shall be deemed waived unless made in writing to us within thirty (30) days from date it was or reasonably should have been discovered. Terms and conditions and limits of liabilities apply. For all terms and conditions see usg.com/terms-and-conditions.

Safety First!

Follow good safety and industrial hygiene practices during handling and installation of all products and systems. Take necessary precautions and wear the appropriate personal protective equipment as needed. Read material safety data sheets and related literature on products before specification and/or installation.

USG  **CGC**
IT'S YOUR WORLD. BUILD IT.™