



# Finishing Drywall Systems

5

## Levels of Gypsum Finishing

The finished appearance of a drywall wall or ceiling is largely dependent upon the quality of the framing job and the care exercised in applying the drywall panels. The better the framing and cladding, the easier it is to have a near-perfect wall. Once that is accomplished, the last remaining challenge is to finish the joints to meet your appearance expectations. This chapter helps you determine the level of quality you need in your finish and shows you how to obtain it.

Note that various organizations provide information about recommended standards or tolerances for finishing of drywall joints. See pages 435 and 442 in the Appendix for information about standards and tolerances.

For instructions on the safe use of joint compounds, texturing materials and related products, see Chapter 13, Safety Considerations, Material Handling.

Contract documents traditionally have used nonspecific terms such as 'industry standards' or 'workmanlike finish' to describe how finished gypsum board walls and ceilings should look. This practice often has led to misunderstanding about the degree of finishing sophistication required for any particular job.

A collective effort of four industry trade associations—Association of the Wall and Ceiling Industries-International (AWCI), Ceilings and Interior Systems Construction Association (CISCA), Gypsum Association (GA) and Painting and Decorating Contractors of America (PDCA)—has resulted in the adoption of industry-wide recommended specifications on levels of gypsum board finish. The work identifies five specific levels of finishing, enabling architects to more closely identify the sophistication required and allowing for better competitive bidding among contractors. ASTM recognized this specification by including the levels of gypsum board finishing in ASTM C840.

Key factors used in determining the sophistication level required include the location of the work to be done, type and angle of surface illumination (both natural and artificial lighting), orientation of the panels during installation (see page 96), type of paint or wall covering to be used and method of application. Critical lighting conditions, gloss paints and thin wall coverings require a high level of finish, while heavily textured surfaces or surfaces that will be decorated with heavy-gauge wall coverings require less sophistication.

Definitions of the five levels of finishing are provided below, together with a matrix that helps detail how each level of finishing is achieved, using SHEETROCK Brand joint treatment and finishing products, and the appearance of the finished wall that may be anticipated for each level.

Applications of SHEETROCK Brand joint treatment products to joints, beads, trims and corners is described on pages 161-167. The number of layers of compound and the degree of finishing advances to meet the requirements of each level.

# Finishing Level Definitions

The following finishing level definitions are based on GA-214-96, "Recommended Levels of Gypsum Board Finish," and are intended to provide an industry standard for drywall finishing.

**Level 0** Used in temporary construction or wherever the final decoration has not been determined. Unfinished. No taping, finishing or corner beads are required. Also could be used where non-predecorated panels will be used in demountable-type partitions which are to be painted as a final finish.

**Level 1** Frequently used in plenum areas above ceilings, in attics, in areas where the assembly would generally be concealed or in building service corridors and other areas not normally open to public view. Some degree of sound and smoke control is provided; in some geographic areas, this level is referred to as "fire-taping," although this level of finish does not typically meet fire-resistant assembly requirements. Where a fire resistance rating is required for the gypsum board assembly, details of construction should be in accordance with reports of fire tests of assemblies that have met the requirements of the fire rating imposed.

All joints and interior angles shall have tape embedded in joint compound. Accessories are optional at specifier discretion in corridors and other areas with pedestrian traffic. Tape and fastener heads need not be covered with joint compound. Surface shall be free of excess joint compound. Tool marks and ridges are acceptable.

**Level 2** May be used with setting-type compound for areas where water-resistant gypsum backing board, specification ASTM C630, is used as a substrate for tile. It may also be specified for standard gypsum board surfaces in garages, warehouse storage or other similar areas where surface appearance is not of primary importance.

All joints and interior angles shall have tape embedded in joint compound and shall be immediately wiped with a joint knife or trowel, leaving a thin coating of joint compound over all joints and interior angles. Fastener heads and accessories shall be covered with a coat of joint compound. Surface shall be free of excess joint compound. Tool marks and ridges are acceptable.

**Level 3** Typically used in areas which are to receive heavy texture (spray or hand applied) finishes before final painting, or where commercial-grade (heavy duty) wallcoverings are to be applied as the final decoration. This level of finish should not be used where smooth painted surfaces or where lighter weight wallcoverings are specified. The prepared surface shall be coated with a drywall primer prior to the application of final finishes.

All joints and interior angles shall have tape embedded in joint compound and shall be immediately wiped with a joint knife or trowel, leaving a thin coating of joint compound over all joints and interior angles. One additional coat of joint compound shall be applied over all joints and interior angles. Fastener heads and accessories shall be covered with two separate coats of joint compound. All joint compounds shall be smooth and free of tool marks and ridges. The prepared surface

shall be covered with a drywall primer prior to the application of the final decoration.

**Level 4** This level should be used where residential grade (light duty) wall coverings, flat paints or light textures are to be applied. The prepared surface shall be coated with a drywall primer prior to the application of final finishes. Release agents for wall coverings are specifically formulated to minimize damage if coverings are subsequently removed. The weight, texture and sheen level of the wallcovering material selected should be taken into consideration when specifying wall-coverings over this level of drywall treatment. Joints and fasteners must be sufficiently concealed if the wallcovering material is lightweight, contains limited pattern, has a glossy finish or has any combination of these features. In critical lighting areas, flat paints applied over light textures tend to reduce joint photographing. Gloss, semigloss and enamel paints are not recommended over this level of finish.

All joints and interior angles shall have tape embedded in joint compound and shall be immediately wiped with a joint knife or trowel, leaving a thin coating of joint compound over all joints and interior angles. In addition, two separate coats of joint compound shall be applied over all flat joints and one separate coat of joint compound applied over interior angles. Fastener heads and accessories shall be covered with three separate coats of joint compound. All joint compounds shall be smooth and free of tool marks and ridges. The prepared surface shall be covered with a drywall primer prior to the application of the final decoration.

**Level 5** The highest quality finish is the most effective method to provide a uniform surface and minimize the possibility of joint photographing and of fasteners showing through the final decoration. This level of finish is required where gloss, semigloss or enamel are specified, or when flat joints are specified over an untextured surface, or where critical lighting conditions occur. The prepared surface shall be coated with a drywall primer prior to the application of final decoration.

All joints and interior angles shall have tape embedded in joint compound and immediately wiped with a joint knife or trowel, leaving a thin coating of joint compound over all joints and interior angles. Two separate coats of joint compound shall be applied over all flat joints and one separate coat of joint compound applied over interior angles. Fastener heads and accessories shall be covered with three separate coats of joint compound. A thin skim coat of joint compound shall be trowel applied to the entire surface. Excess compound is immediately sheared off, leaving a film or skim coating of compound completely covering the paper. As an alternative to a skim coat, a material manufactured especially for this purpose may be applied. The surface must be smooth and free of tool marks and ridges. The prepared surface shall be covered with a drywall primer prior to the application of the final decoration.

The following matrix helps define the expected appearance of each level and basic requirements for achieving that level. Additional guidelines are offered for meeting the specified finish level using SHEETROCK Brand products and application techniques.

**Finishing Level Matrix**

Finishing Level	Final Appearance	How To Achieve Result		
		Joints & Interior Angles	Accessories & Fasteners	Surface
5	Entire surface covered with a) SHEETROCK Brand Primer Surfacer (TUFF-HIDE) or b) Skim coat of compound and ready to prime before decorating with gloss, semigloss or enamel paint.	As in Level 4	As in Level 4	SHEETROCK Brand Primer Surfacer (TUFF-HIDE) or skim coat and prime with CGC First Coat, SYNKO Brand Pre-Coat before painting or texturing
4	No marks or ridges. Ready for priming, followed by wallcoverings, flat paints or light textures.	Two separate coats of compound over Level 2	Three separate coats of compound	Joints filled and smoothed again. Shall be primed with CGC First Coat before painting or texturing
3	No marks or ridges. Ready for priming, to be followed by heavy texture.	One separate coat of compound over Level 2	Two separate coats of compound	Joints filled and smooth. Shall be primed with CGC First Coat before painting or texturing
2	Tool marks and ridges okay. Thin coating of compound covers tape; one coat compound over fastener heads.	Tape embedded in compound and immediately wiped to leave a thin coating of compound over tape	One coat of compound	Free of excess compound
1	Tool marks and ridges acceptable.	Tape embedded in compound	Optional—One coat of compound	Free of excess compound
0	Unfinished	None		

## Recommended Levels of Paint Finish Over Gypsum Board

The recommended level of paint finish over gypsum board wall and ceiling surfaces varies depending on location in the structure, the type of paint applied, the finish achieved on the gypsum board substrate prior to final decoration and the type of illumination striking the surface. The following recommendations from the Drywall Finishing Council Incorporated describe various levels of paint finish as the final decoration over new interior gypsum board surfaces.

### Level 0

No painting required. Note that this is recommended where final decoration is not required.

### Level 1

- a. When final decoration is undetermined, all appropriately prepared gypsum board surfaces shall have one coat of drywall primer applied. Drywall primer shall be applied to the mil film thickness and application conditions specified by the primer manufacturer.

or

- b. When wallcoverings are to be applied, all appropriately prepared gypsum board surfaces shall have one coat of wallcovering primer applied.

Wallcovering primer shall be applied to the mil film thickness and application conditions specified by the primer manufacturer.

**Level 2**

All appropriately prepared gypsum board surfaces shall have one coat of topcoat material applied to yield a uniform surface. Paint shall be applied to the mil film thickness and application conditions specified by the paint manufacturer. Note that the painted surface may not achieve uniform appearance, color or sheen, but shall be absent of defects caused by the painting contractor's workforce. This level is recommended where economy is of primary concern.

**Level 3**

All appropriately prepared gypsum board surfaces shall have two separate coats of topcoat material applied to yield a properly painted surface. Paint shall be applied to the mil film thickness and application conditions specified by the paint manufacturer. Note that this is typically recommended for areas having textures (spray or hand applied) over a primed gypsum board surface and the area is not subject to critical lighting. Refer to Drywall Finishing Council document titled, "Recommended Specification For Preparation of Gypsum Board Surfaces Prior To Texture Application." When subjected to critical lighting, a Level 5 gypsum board finish as defined in GA-214-96 ("Recommended Levels of Gypsum Board Finish") is recommended.

**Level 4**

All appropriately prepared gypsum board surfaces shall have one coat of drywall primer applied to yield a properly painted surface and one separate coat of topcoat material applied to a properly painted surface over the drywall primer. Paint shall be applied to the mil film thickness and application conditions specified by the paint manufacturer. Note that this is typically recommended for smooth surfaces not subject to critical lighting and areas having light to medium texture finishes (spray or hand applied over a primed gypsum board surface). Refer to Drywall Finishing Council document titled, "Recommended Specification For Preparation of Gypsum Board Surfaces Prior To Texture Application." When subjected to critical lighting, a Level 5 gypsum board finish as defined in GA-214-96 is recommended.

**Level 5**

All appropriately prepared gypsum board surfaces shall have one coat of drywall primer applied to yield a properly painted surface. Two separate coats of topcoat material shall be applied over the drywall primer to yield a properly painted surface. Paint shall be applied to the mil film thickness and application conditions specified by the paint manufacturer. Note that this level is recommended where the best paint finish is required, such as under critical lighting conditions or when paints that have a glossy surface are used. Recommended with a Level 5 gypsum board finish as described in the "Recommended Levels of Gypsum Board Finish" (GA-214-96). This system, when combined with the Level 5 gypsum board finish is the most effective method to minimize joint and fastener photographing and provides the most uniform final finish.

## Trim Accessory Application

Trim accessories simplify and enhance the finishing of gypsum board assemblies. The accessories are low in cost, easily applied and designed to work together for long-lasting, trouble-free construction. All are suitable for steel-frame and wood-frame construction.

### Corner Bead Application

SHEETROCK/BEADEX Brand corner reinforcements provide strong, durable protection for outside angle corners, uncased openings, pilasters, beams and soffits. The exposed nose of the bead resists impact and forms a screed for finishing. Corner bead should be installed in one piece unless the length of corner exceeds stock bead lengths. Install as noted for each product.

**SHEETROCK/BEADEX Brand Paper Faced Metal Corner Bead** is a solid-flange corner bead with a specially formulated paper laminated to its surface. The combination of materials assures strong corner protection plus an extraordinary bonding mechanism that eliminates edge cracking problems commonly experienced with conventional bare metal bead. The bead is affixed by applying a laminating layer of joint compound between the rough corner and the bead. This is accomplished by 1) hand applying compound to the gypsum board with a 102 mm (4") drywall knife, or 2) using a mechanical angle applicator to apply compound to the wall surface, or 3) hopper-applying joint compound to the back of the bead. Once the joint compound is uniformly applied, the bead is simply pressed in place by hand or with a bead roller, then finished in a normal fashion.

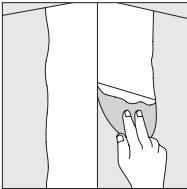

Hand Application

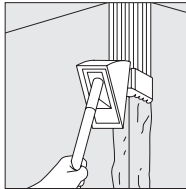

Mechanical Application

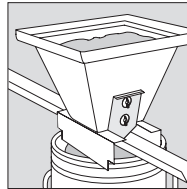

Hopper Application

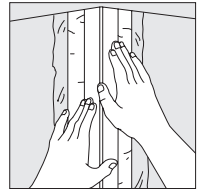

Press in Place

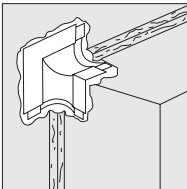

Transition Corner

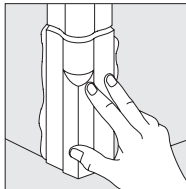

Transition Cap

If paper-faced bullnose corner bead is used, transition corners and transition caps are available to assure smooth transitions around corners and from bullnose wall corners to square baseboard corners.

There are also a variety of paper-faced trim products. In general, these are installed in the same way as the beads. Among these are the following special trim products:

- SHEETROCK/BEADEX Brand Paper Faced Metal Inside Corner, Tape On Trim (B2), forms true inner 90-degree corner angles.
- SHEETROCK/BEADEX Brand Paper Faced Metal Offset Inside Corner, Tape On Trim (B2 OS), is designed for 135-degree inside corner offset angles.
- SHEETROCK/BEADEX Brand Paper Faced Metal Inner Cove, Tape On Trim (SLIC), creates smooth, rounded inside corners.
- SHEETROCK/BEADEX Brand Paper Faced Metal Offset Inner Cove, Tape On Trim (SLIC OS), is a softline (bullnose) inside corner for 135-degree offset angles.
- SHEETROCK/BEADEX Brand Paper Faced Metal “L” Shaped, Tape On Trim (B4 Series), is a trim used where wallboard abuts suspended ceilings, beams, plaster and concrete walls; also used at untrimmed door and window jambs; available with and without bead.
- SHEETROCK/BEADEX Brand Paper Faced Metal Reveal, Tape On Trim (Reveal NB), is a modified tape-on “L” trim which can be used to create reveals on soffits, walls and ceilings, around light boxes and other architectural components.
- SHEETROCK/BEADEX Brand Paper Faced Metal “J” Shaped, Tape On Trim (B9), is a J-trim that completely surrounds the rough edge of wallboard, providing a strong, clean corner.
- SHEETROCK/BEADEX Brand Paper Faced Metal Premasked L-Shaped, Tape On Trim (Premasked L), provides a serrated paper strip that protects the adjacent surfaces of ceiling or wall intersections. Simply tear away the protective strip after the job is completed, leaving virtually no clean up of the adjacent surface.

**SHEETROCK/BEADEX Brand Flexible Metal Corner Tape** is a flexible reinforcement that ensures straight, sharp corners on any angle. It provides durable corner protection on cathedral and drop ceilings, arches and around bay windows. The tape is available in two widths: 52 mm (2-1/16”) and 102 mm (4”). The 52 mm (2-1/16”) width has a 1.6 mm (1/16”) gap between two 11 mm (7/16”)-wide galvanized, rust-resistant steel strips and the 102 mm (4”) width has two 22 mm (7/8”)-wide galvanized, rust-resistant steel strips. When folded, the tape forms a strong corner bead. It is applied with standard joint compound, feathered at the edges for a smooth wall surface. It is also useful for joining drywall partitions to plastered walls in remodeling and for repairing chipped and cracked corners. Available in convenient 30 m (100’) rolls in dispenser box.

To install: Cut tape to length desired with snips or score with knife and bend. Notch or angle cut for arches and window returns. Do not overlap at intersections or corners. Apply joint compound to both sides of corner angle, fold tape at its center to form a bead and press the metal strip side into joint compound. Follow immediately with a thin coat of compound over the tape and let dry. Finish the corner in the conventional manner with additional coats of joint compound.



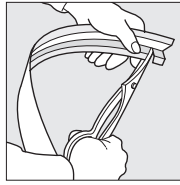

Cut tape with snips.

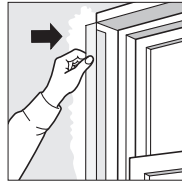

Embed in joint compound.

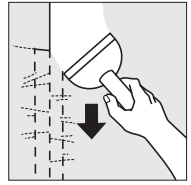

Finish corner.

**Corner Bead** is a galvanized solid-flange, is designed for protecting external corners. It may be nailed through the board to wood framing or staple attached with 14 mm (9/16") galvanized staples to the board alone in either wood- or steel-framed construction. A special clinch-on tool also may be used for flange attachment. Bead should be attached at 229 mm (9") intervals in both flanges with fasteners placed opposite one another. Flange widths available: 32 x 32 mm (1-1/4" x 1-1/4"); 29 x 29 mm (1-1/8" x 1-1/8").

*Clinch-on tool crimps solid-flange beads into place.*

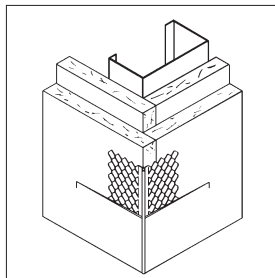
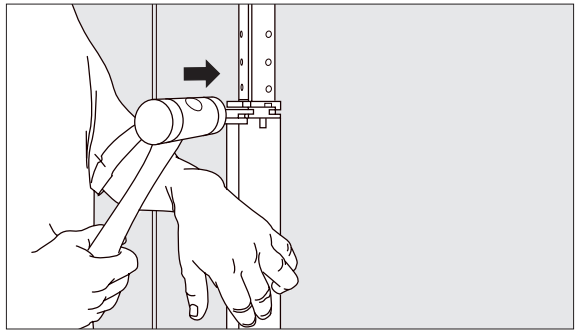

Meshed Corner Bead

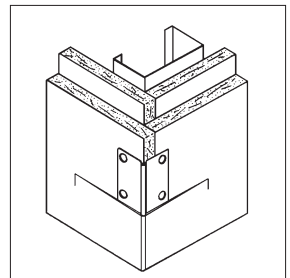

Corner Bead

Meshed Corner Bead is a galvanized fine-mesh, expanded-flange corner bead. The mesh flange provides exceptional joint compound bond and reinforcement. It may be attached with nails or staples directly opposite one another at 229 mm (9") intervals. Finishing with three coats of a CGC/Synko Brand Joint Compound is recommended.

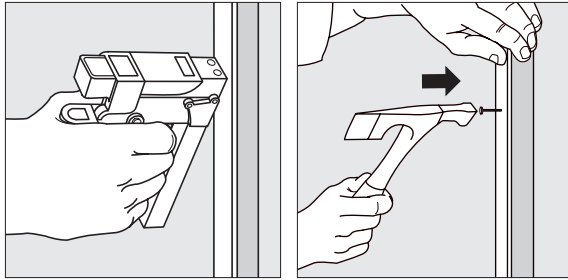

*Stapling is the standard way to attach meshed Corner Bead.*

*For wood studs, nails in both bead flanges are also satisfactory.*

## **Metal Trim Application**

Metal Trim serves to protect and finish gypsum panels at window framing and door jambs; they are also used at ceiling-wall intersections and partition perimeters to form a recess for acoustical sealant. Also serve as a relief joint at the intersection of dissimilar constructions, such as gypsum board to concrete.

Metal trims provide maximum protection and neat finished edges to gypsum panels at window and door jambs, at internal angles and at intersections where panels abut other materials. The trim pieces are easily installed by nailing or screwing through the proper leg of trim. Various configurations are available depending on the required application.

J-shaped metal trim, (12.7 mm (1/2") and 15.9 mm (5/8") size)—Apply gypsum panels, omitting fasteners at framing member where trim is to be installed. Leave a space 9.5 mm (3/8") to 12.7 mm (1/2") wide between edge of panel and face of jamb. This provides space for installation of hardware. Slip trim over edge of panel with wide knurled flange on room side and fasten trim and panel to framing. Use same type fasteners used to attach panels; space fasteners 229 mm (9") o.c. max. Finish with three coats of conventional joint compound; only two coats are required with lightweight all purpose ready-mixed joint compound.

L-shaped metal trim, (12.7 mm (1/2") and 15.9 mm (5/8") size)—Apply gypsum panels the same way as for J-shaped metal trim, omitting fasteners and leaving 9.5 mm (3/8") to 12.7 mm (1/2") space at jamb. Place trim over edge of panel with knurled flange exposed. Attach trim and panel to framing with fasteners spaced 229 mm (9") o.c. max. Finish with three coats of conventional joint compound; only two coats are required with lightweight all purpose ready-mixed joint compound.

J-trim application—Apply the trim to the wall before the gypsum panels go up, by nailing through trim flange into framing; board is held firmly in place by short leg of trim. No additional edge fastening is necessary. Space fasteners 229 mm (9") o.c. Requires no finishing compound.

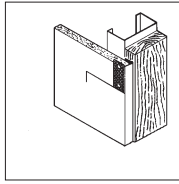

*Metal J-Trim*

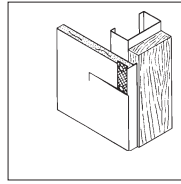

*Metal L-Trim*

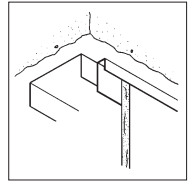

*Metal J-Stop*

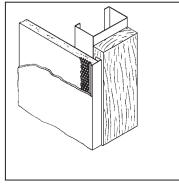

*801-A Expanded  
Flange J-Trim*

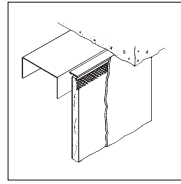

*801-B Expanded  
Flange L-Trim*

Meshed metal trim application—Slip channel-type 801-A Trim over the edge of the board, or position L-shaped trim on the edge of the board with the expanded flange on the room side. Fasten with staples or nails 229 mm (9") o.c. max. for drywall applications. Finish with three coats of conventional joint compound (only two coats are required with lightweight all purpose ready-mixed joint compound).

## Control Joint Application

Proper installation of control joints in wall and ceiling membranes should include breaking the gypsum boards behind the control joint. In ceiling construction, the framing should also be broken, and in partitions, separate studs should be used on each side of the control joints. Control joints should be positioned to intersect light fixtures, air diffusers, door openings and other areas of stress concentration.

Gypsum construction should be isolated with control joints where (a) partitions or ceilings of dissimilar construction meet and remain in the

same plane; (b) wings of “L”, “U” and “T” shaped ceiling areas are joined; and (c) expansion or control joints occur in the base wall construction and/or building structure. Just as important, control joints should be used in the face of gypsum partitions and ceilings when the size of the surface exceeds the following control-joint spacings; Partitions, 9 m (30 ft.) maximum in either direction; Interior Ceilings (with perimeter relief), 15 m (50 ft.) maximum in either direction; Interior Ceilings (without perimeter relief), 9 m (30 ft.) maximum in either direction; and Exterior Ceilings, 9 m (30 ft.) maximum in either direction.

Ceiling-height door frames may be used as vertical control joints for partitions; however, door frames of lesser height may only be used as control joints if standard control joints extend to the ceiling from both corners of the top of the door frame. When planning locations for control joints in the ceiling, it is recommended that they be located to intersect column penetrations, since movement of columns can impose stresses on the ceiling membrane.

Control Joints, when properly insulated and backed by gypsum panels, have been fire-endurance tested and are certified for use in one- and two-hour-rated walls.

### Installation

At control joint locations:

1. Leave a 12.7 mm (1/2") continuous opening between gypsum boards for insertion of surface-mounted joint.
2. Interrupt wood floor and ceiling plates with a 12.7 mm (1/2") gap, wherever there is a control joint in the structure.
3. Provide separate supports for each control joint flange.
4. Provide an adequate seal or safing insulation behind control joints where sound and/or fire ratings are prime considerations.

Control Joint No. 093—Apply over the face of gypsum board where specified. Cut to length with a fine-toothed hacksaw (32 teeth per in.). Cut end joints square, butt together and align to provide a neat fit. Attach the control joint to the gypsum board with Bostitch 14 mm (9/16") Type G staples, or equivalent, spaced 152 mm (6") o.c. max. along each flange. Remove the plastic tape after finishing with joint compound.

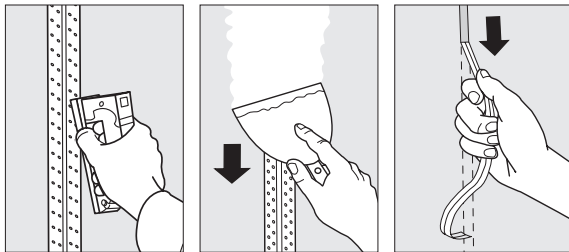

*Control Joint No. 093 stapled, finished, tape removed.*

## Fire-Rated Control Joints

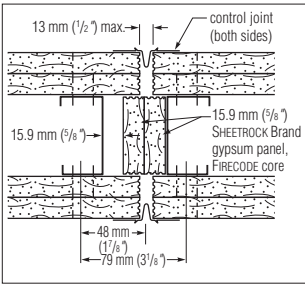

**47 STC (SA-860302);  
2-hr. Fire Rating  
(steel stud partitions)**

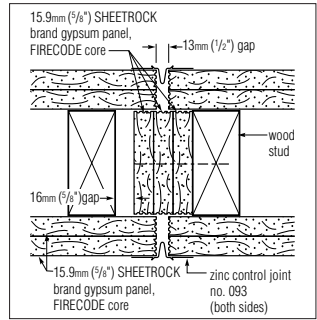

**2 Hr. fire resistance—  
estimated based on WH-651-0318.1  
(wood stud partitions)**

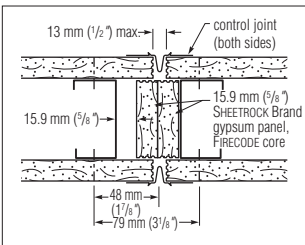

**1-hr. Fire Rating  
(steel stud partitions)**

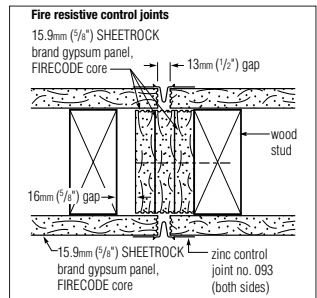

**1 Hr. fire resistance—  
estimated based on WH-651-0318.1  
(wood stud partitions)**

5

## Maximum Spacing—Control Joints

	Max. Single Dimension	
Construction & Location	m	ft.
Partition-interior	9	30
Ceiling-interior		
with perimeter relief	15	50
without perimeter relief	9	30
Ceiling-exterior gypsum	9	30

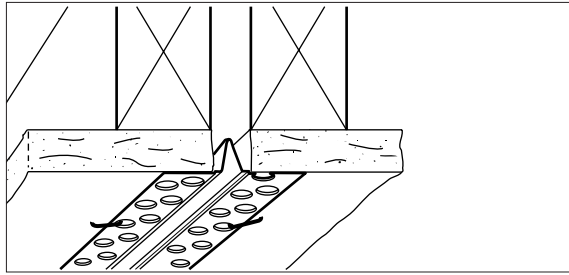

## Joint Treatment for Drywall Construction

### Application Conditions

In cold weather during joint finishing, temperatures within the building should be maintained within the range of 13° (55°) to 21°C (70°F) and adequate ventilation should be provided. Also see “Good Weather or Foul Weather Drywall finishing,” CGC folder EJC-1518.

### Check Working Surfaces

Gypsum panels must be tightly fastened to framing members without breaking the surface paper or fracturing the core. Make certain panel joints are aligned. When one panel is higher than another it becomes difficult to leave sufficient compound under the tape covering the high panel. Blisters, bond failure and cracks can easily develop in these areas.

Open spaces between panels of 6.4 mm (1/4”) or more should be filled with compound at least 24 hours prior to embedding or first-coat work. Setting-type joint compounds, which are hardening types, are recommended for these large fills. With these setting-type compounds as a fill, joint treatment may begin as soon as the compound has hardened, eliminating the typical 24-hr. drying period. Good planning prior to hanging panels eliminates unnecessary joints.

### Care of Equipment

Applicators must keep tools and equipment clean and in good repair to secure satisfactory results. With mechanical tools, parts must be replaced when they show signs of wear.

Mixing joint compounds in dirty buckets or failure to wash down the exposed container sides as material is used causes lumps, scratches and usually creates hard working material. With setting-type materials a residue of dry compounds will shorten setting time of the new batch.

The hardening action of setting-type joint compounds requires that all tools, mixing containers, mud pans, etc., used for application be thoroughly cleaned. Flush and clean these compounds from equipment and brush before the setting action takes place. Immersion of equipment in water will not prevent hardening of the compound.

Mechanical tool application is not recommended with fast-setting joint compounds.

### Mixing Joint Compounds

1. Mix powder joint compounds in a clean 19-L (5-gal.) container—(preferably plastic) for setting-type joint compounds. A hand mixer resembling a commercial potato masher makes a convenient mixing tool. Power mixing saves considerable time, particularly where mixing in a central location is convenient. Power mixing is highly recommended.

Power may be supplied by a 12.7 mm (1/2") heavy-duty electric drill operating at 450 to 650 rpm. Drills operating at high speeds whip air into the compound, and also accelerate setting of setting-type compounds. (See page 400 for information about mixing paddles.) Small amounts of powder joint compounds may be mixed in a small bowl or mud pan. Keep mixing buckets and tools clean at all times. Containers having any residue of joint compounds in them may cause premature hardening, scratching and incompatibility problems.

2. Pour proper amount of clean drinkable water into a container. Use room-temperature water, as very cold or hot water will affect the set time. The amounts for type of application and product used are shown in the directions on the package. Dirty water (such as that used to clean tools) will contaminate compound and cause erratic setting of setting-type compounds.
3. Sift powder joint compound into water, allowing complete wetting of the powder.
4. Mix as shown below:
  - a. For powder joint compounds, follow mixing directions on the bag. Do not overmix; this may speed up hardening time. Note: Keep compound from being contaminated by any other materials such as other type joint compounds, dirty water or previously mixed joint compound. Contamination will affect the hardening time and properties of the compound. Do not remix if product has started to set. Overmixing or retempering of setting-type joint compounds will affect the set time and reduce strength development.

Mix only as much joint compound as can be used within time period shown on bag (usually about 30 minutes for DURABOND 45, 1 hour for DURABOND 90, for example).

The compound will harden chemically after this time period, even under water. Do not attempt to hold wet mix or immerse joint compound-coated tools in water to hold back hardening. Retempering the compound is not recommended.

An accelerator may be used to alter the set time of the compound. CGC Gypsum Accelerator-High Strength is an accelerator that was developed for use in conventional basecoat plaster products, but can be used to reduce the setting time of joint compounds.

- b. For ready-mixed compounds (drying type), mix contents and use at package consistency for fasteners and corner beads. Should be thinned for taping and finishing and for use with mechanical tools. Add water in half-pint increments to avoid overthinning. Remix and test apply after each water addition. Either hand mixer or drill mixer can be used to mix compounds.

Use cool to lukewarm (not hot) water. If compound should accidentally be overthinned, simply add more Ready-Mixed Compound to thicken, then remix.

To hold the wet mix in a container for prolonged periods, wash down the exposed container sides, cover the material with a wet cloth or a thin layer of water and put the lid back on the pail. When needed, pour off water and adjust to a working viscosity.

Ready-mixed compound is sensitive to cold weather and must be protected from freezing. If material freezes in container, allow it to thaw at room temperature (do not force the thawing process). Do not pour off any liquid that has separated from the compound. Remix using a power drill mixer until smooth and creamy. Usually it will again be usable, unless it has been subjected to several freeze-thaw cycles.

Ready-mixed compound can be used in tools and containers previously used for powder compound after normal cleaning.

## Hand Tool Application

**Embedding Tape** Make sure no fasteners protrude above the gypsum panel surface. Using a broad steel finishing knife, apply a continuous coat of taping, all-purpose or setting-type joint compound to fill the channel formed by the tapered edges of the panels. Center and lightly press CGC or SYMKO Brand Joint Tape into fresh joint compound. Working within a convenient arms-reach area, embed tape by holding knife at an angle to panel. Draw knife along joint with sufficient pressure to remove excess compound above and below tape and at edges (see illustration).

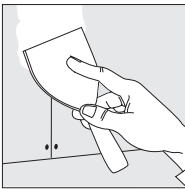

Apply a thin coat of taping compound, above; press joint tape into compound; draw knife over tape to remove excess compound, right.

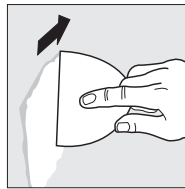
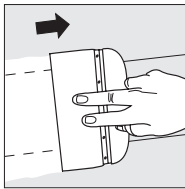
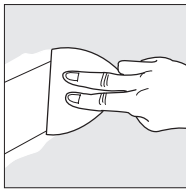

Apply a thin coat of joint compound over tape, above; apply taping compound, all-purpose or setting-type, over fasteners, right.

Leave sufficient compound under tape for proper bond but not over 0.8 mm (1/32") under edge. While embedding, apply a thin coat of joint compound over the tape (above). This thin coat reduces edge wrinkling or curling and makes the tape easier to conceal with following coats. Allow to dry completely. (See drying and setting time guides on pages 174 and 176.) Do not use topping compound for embedding tape.

For interior corners, apply compound to each side of the 90° inside corner. Crease CGC or SYMKO Brand Joint tape down the center with fingers and embed into joint compound. Use knife to embed tape into compound, first on one side of the angle, then the other.

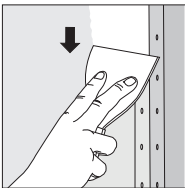

Apply all-purpose or setting-type taping compound, at least 150 mm (6") wide, over all corner beads and trims that are to receive joint compound.

**Spotting Fastener Heads** Use ready-mixed compounds at package consistency or powder compounds mixed per bag directions. Do not add excess water. Apply all-purpose or setting-type joint compound over all fasteners (above, right) immediately before or after embedding tape. Fill only the fastener depression. Apply enough pressure on knife to level compound with panel surface. Allow each coat to dry. Repeat application until fastener depressions are flush with panel surface (normally two or three applications).

**Filling Beads** Use ready-mixed compounds at package consistency or powder compounds mixed per bag directions. Apply all-purpose or setting-type compound at least 150 mm (6") wide over all corner



beads (below) and to trims that are to receive compound. Allow each coat to dry. Apply following coats approximately 50 mm (2") wider than preceding coats. For smoother finishing, the final coat of joint compound may be thinned slightly.

*Paper-faced metal drywall bead is applied quickly by applying joint compound to the bead with an installation hopper. Bead is then pressed onto corner.*



5

**Paper-Faced Metal Beads and Trims** Paper-faced metal beads and trims perform the same function as bare metal or vinyl beads and trims, but are applied at the taping stage rather than at the cladding stage of the drywall job. SHEETROCK/BEADEX Brand Paper-Faced Metal Bead and Trim are preferred because the paper bonds with the joint compound and drywall surface to provide superior resistance to edge cracking and chipping despite the stresses of normal building movement and everyday wear and tear.

Unlike conventional metal or vinyl, which are mechanically attached to the board surface, paper-faced metal beads and trims are adhesively applied using CGC/SYNKO Brand Setting-Type, or CGC/SYNKO Brand Ready-Mixed (Taping or All Purpose) Joint Compounds. Topping compounds are not recommended for embedding bead. The paper facing assures excellent adhesion of joint compounds, textures and paints for a strong, smooth finish.

Apply the joint compound by hand or mechanically to the wallboard and then press the bead in place, or apply joint compound by hopper to the inside of the bead (see illustrations above), then mount in position on board corners. The bead is then finished in the same manner as other beads.

**Fill Coat Application** After the tape embedding coat is dry, apply a topping or all-purpose compound fill (second) coat approx. 180 mm (7") to 250 mm (10") wide over taped joints (shown below), beads and trim. Feather edge of second coat approx. 50 mm (2") beyond edge of first coat. Spot fasteners with second coat. Allow to dry.

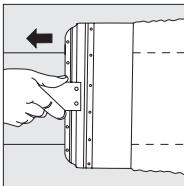

*After tape embedding coat is dry, apply topping coat 180 mm (7") to 250 mm (10") wide over joints, beads and trim.*

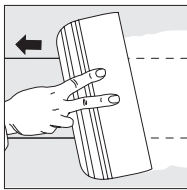

Apply topping compound over joints, fasteners, beads and trim with edges 50 mm (2") wider than previous coat.

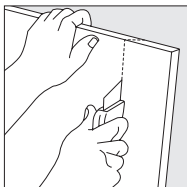

Bevel edges of butt ends of drywall panels before applying joint compound.

**Finish Coat Application** After second coat is dry, smooth tool marks and other protrusions with a finishing knife. Apply a thin finish (third) coat of ready-mixed, topping or all-purpose compound over joints, fasteners, beads and trim. Finish compound should be applied at a slightly thinner consistency. Feather edges of third coats at least 50 mm (2") wider than second coats (left). Joints, fasteners, beads and trim should be finished as smooth as possible to minimize sanding. Go over the whole job to smooth and touch up with joint compound all scratches, craters, nicks and other imperfections in the dried finish coat.

**End Joints** Because ends of gypsum panels are flat and have no taper like panel edges, end joints are difficult to conceal. Also, exposed paper on ends may cause visible ridging or beading. The following steps are recommended for joint treatment to minimize crowning and/or ridging of end joints:

1. Before attachment, bevel panel ends approx. 3 mm (1/8") at a 45° angle using a sharp utility knife. This keeps the paper ends apart and reduces expansion problems caused by the raw paper edge. Also, peel back and remove any loose paper from the end.
2. Gypsum panel ends should be loosely butted together. Ends should be separated slightly and not touching.
3. Prefill the recess with compound and allow to set or dry.
4. Apply compound and paper reinforcing tape over the joint in the same manner as for tapered joints. Embed tape tightly to minimize joint thickness but leave sufficient compound under tape for continuous bond and blister prevention.
5. Finish the end joint to a width at least twice the finish width of a recessed edge joint. This will make the joint less apparent after decoration as the crown will be more gradual.

**Finishing Inside Corners** Fold tape along center crease. Apply joint compound to both sides of corner and press folded tape into angle. Tightly embed tape into both sides of angle with finishing knife and let dry. Next, apply a thin coat to one side of angle only. Allow to dry before applying finish coat to other side of angle.

**Dry Sanding** Sand joint compounds to prepare gypsum drywall surfaces for decoration. Sand as necessary to remove excess joint compound from tool marks, lap marks and high crowned joints. Scratches, craters and nicks should be filled with joint compound, then sanded. Do not try to remove these depressions by sanding only.

Select sandpaper or abrasive-mesh cloth with grit as fine as possible. Excessively coarse sandpapers leave scratches that are visible after decoration. For conventional-weight all-purpose compounds, use #120 grit or finer sandpaper (#200 grit or finer mesh cloth or 100 micron or less polyester film-back abrasive sheets). For lightweight, midweight and topping compounds, use #150 grit or finer sandpaper (#220 grit or finer mesh cloth or 80 micron or less polyester film-back abrasive sheets). Only sand surfaces coated with joint compound to avoid scuffing gypsum panel paper. Remove sanding dust before decorating.

Ventilate or use a dust collector to reduce dust in work areas. Use a NIOSH-approved respirator specified for mica and talc when air is dusty. Use of safety glasses is recommended.

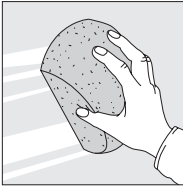

*Wet sanding avoids creating dust.*

**Wet Sanding** Wet sanding or sponging finished joints, bead, trim and fasteners is suggested rather than dry sanding to avoid creating dust. The best material to use for wet sanding is a high density, small celled, polyurethane sponge. This type of sponge material resembles high quality carpet padding. When only a touch-up is required, a general purpose sponge or smooth, soft cloth will work.

To wet sand, saturate the sponge with clean water containing no soap or additives. Water temperature should be cool to lukewarm, not hot. Wring out sponge only enough to eliminate dripping. To remove high spots, moisten the joint compound with the sponge, then pull a joint knife across. Use as few strokes as possible. Excessive rubbing will groove joints. Clean sponge frequently.

### Mechanical Tool Application

Several types of mechanical and semi-mechanical tools are available. Tools used in the following sequence illustrate typical procedures.

- 1, 2 Using compound of suitable consistency, mechanically tape all joints; wipe down with broad knife. Allow to dry.
- 3, 4 Mechanically apply tape and compound to the interior angles. Smooth the tape and compound in the angles with corner roller and corner finisher. Touch up with broad knife as necessary. Apply first coat to fastener heads and metal accessories. Allow to dry.
- 5 Apply fill coat of compound over tape on flat joints using a flat finishing box (above). Using compound of thicker consistency, spot fastener heads and apply second coat to metal accessories. Allow to dry.

Apply finish coat of compound to flat joints with a wider finishing box. Apply finish coat to the interior corner angles with the corner applicator box. Apply finish coat to metal accessories and fastener heads. Allow to dry and smooth lightly as required. Remove all dust before decoration. Do not scuff face paper by oversanding.

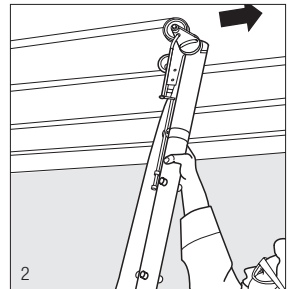
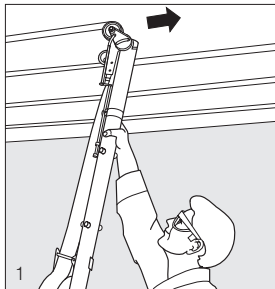

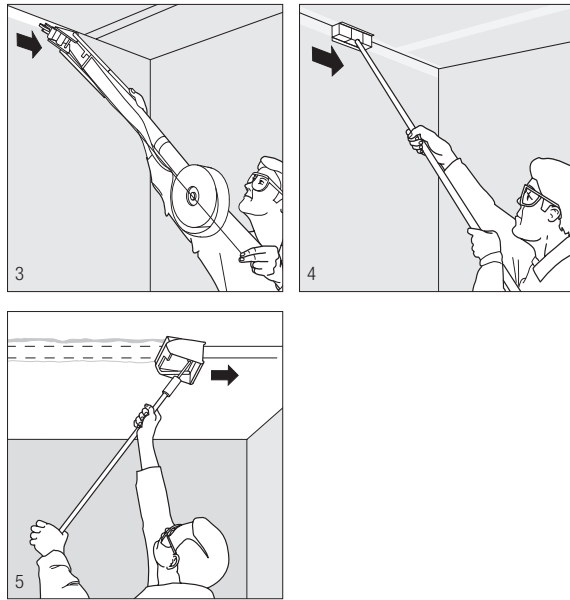

## Setting-Type Joint Compounds — System Applications

Setting-type joint compounds are chemical hardening products with varied working (setting) times for finishing interior gypsum panels and exterior gypsum ceiling boards (DURABOND 90). These specialized products provide short setting times for fast one-day finishing and extended times to suit individual needs. The following application guide will help you choose the proper product to meet your requirements.

### Application Guide—Setting-Type Joint Compounds

Compound Type	Setting Time-Min.	Working Time-Min.	Recommended Application
20 SHEETROCK	20-30	15	application needing very short working time
45 SHEETROCK	30-80	20	spot fastener heads embed metal beads
90 SHEETROCK	85-130	60	all applications
30 PRO-SET LITE Sand	30	15	all applications needing short working time
90 PRO-SET LITE Sand	90	60	all applications

**For One-Day Finishing** Use the techniques shown for hand application; mechanical tool application is not recommended for setting-type joint compounds because these compounds may harden in the tools, making them inoperable. If mechanical tool application is required, caution must be taken in selection of product set time to ensure enough working time exists for application and thorough cleanup of tools. In the following sequence, Steps 1 through 4 should be completed by mid-day. Planning and scheduling according to the setting times of the compounds are essential. For best results, use compound that will set within 1-1/2 to 2 hours.

1. Embed CGC or SYNKO Brand Joint Tape over all joints and angles.
2. Apply compound over corner reinforcement. For best results use compound that will set within 1-1/2 to 2 hours.

3. Spot fastener heads.
4. As soon as taping coat has set (hardened even though not dry), apply second (fill) coat over all joints and angles.
5. After the second (fill) coat application has hardened, apply finishing coat of selected finishing compound to completely cover all joints, angles, corner bead and fasteners.

**For SHEETROCK Brand Exterior Ceiling Board Surfaces** Use hand application techniques and a setting-type joint compound to treat joints and fasteners in CGC Exterior Ceiling Board applications. During periods of near-freezing temperatures, check weather forecast before beginning work. Minimum air, water, mix and surface temperatures of 7°C (45°F) must be assured until compound is completely dry.

1. Prefill joints of SHEETROCK Brand Exterior Gypsum Ceiling Board with compound. After prefill has set, tape all joints and angles in the ceiling with compound and CGC or SYNKO Brand Joint Tape. When compound sets (hardens), immediately apply a fill coat of compound; allow to harden before finishing.
2. Apply compound over flanges of control joints, metal beads and trim. Spot all fastener heads.
3. After fill coat has set, apply compound finishing coat. Completely cover all joints, angles, beads, control joints and fasteners.
4. After the joint compound has dried, apply one coat of a good-quality latex flat exterior primer to equalize the joint and wallboard surfaces. Then follow with at least one coat of a balanced, good-quality alkyd or latex exterior finishing system as specified by the paint manufacturer.

**For Use with SHEETROCK Brand Gypsum Panels, W/R** In areas to be tiled, for tapered edge joints, embed CGC or SYNKO Brand Joint Tape with setting-type joint compound. When set, apply a fill coat of the same joint compound. Take care not to crown the joint. Wipe excess joint compound from the water resistant panel surface before it sets. For end joints and interior angles, embed CGC or SYNKO Brand Joint Tape with setting-type joint compound. A fill coat is not necessary. Again, take care not to crown the joint. For fasteners, spot fastener heads at least once with setting-type joint compound. Chapter 4 provides instructions for tile work and substrates for areas subjected to constant moisture.

Fill and seal all openings around pipes, fittings and fixtures with a thinned down coat of a good quality tile adhesive. For best results, use tile adhesive both as a sealer and to set the tile. Thin to a paint-like viscosity and apply the thinned compound with a small brush onto the raw gypsum panel core at the cutouts and allow areas to dry thoroughly prior to application of tile. Before adhesive dries, wipe excess material from the surface of gypsum panels.

For areas not to be tiled, embed tape with setting-type joint compound in the conventional manner. Finish with at least two coats of a joint compound to provide joint finishing for painting and wallpapering.

**Note:** SHEETROCK Brand Gypsum Panels, WR are not intended for use in shower areas or in areas subject to constant moisture, such as interior swimming pools, gang showers and commercial food processing areas. DUROCK Cement Boards are recommended for these uses.

## Drying Time — Joint Compound Under Tape

Standard drying times are based on evaporation of 4.5 kg (10 lb.) water per 76 m (250 ft.) reinforcing tape, corresponding to 1.6 mm (1/16") to 2 mm (5/64") wet compound thickness under the tape. The drying times for thicker (or thinner) coats of wet compound between tape and panels will increase (or decrease) in proportion to the wet compound thickness.

These drying times apply when the exposed surface of tape is bare or nearly bare, and when adequate ventilation is provided. A heavy compound coat over tape lengthens drying time.

### Drying Time—Joint Compound Under Tape

Temp. °C	16°	21°	27°	32°	38°
Temp. °F	60°	70°	80°	90°	100°
98%	18 D	12 D	9 D	6 D	4-1/2 D
97%	12D	9 D	6 D	4-1/2 D	3-1/4 D
96%	10 D	7 D	5 D	3-1/2 D	2-1/2 D
95%	8 D	6 D	4 D	2-3/4 D	2 D
94%	7 D	5 D	3-1/4 D	2-1/4 D	41 H
93%	6 D	4 D	2-3/4 D	2 D	36 H
92%	5 D	3-1/2 D	2-1/2 D	44 H	32 H
91%	4-3/4 D	3-1/4 D	2-1/4 D	40 H	29 H
90%	4-1/2 D	3 D	49 H	36 H	26 H
85%	3 D	2 D	34 H	25 H	18 H
80%	2-1/4 D	38 H	27 H	19 H	14 H
70%	38 H	26 H	19 H	14 H	10 H
60%	29 H	20 H	14 H	10 H	8 H
50%	24 H	17 H	12 H	9 H	6 H
40%	20 H	14 H	10 H	7 H	5 H
30%	18 H	12 H	9 H	6 H	4-1/2 H
20%	16 H	11 H	8 H	5-1/2 H	4 H
10%	14 H	10 H	7 H	5 H	3-1/2 H
0	13 H	9 H	6 H	4-1/2 H	3 H
<b>RH</b>	<b>RH = Relative Humidity</b>		<b>D = Days (24 hr.)</b>	<b>H = Hours</b>	

## Finishing

Gypsum drywall provides smooth surfaces that readily accept paint, texture finishes and wall coverings. For satisfactory finishing results, care must be taken to prepare surfaces properly to eliminate possible decorating problems commonly referred to as 'joint banding' and 'photographing.' These problems are usually caused by differences between the porosities and surface textures of the gypsum panel face paper and the finished joint compound, and magnified by the use of gloss paints. Then, when viewed in direct natural lighting, the joints and fasteners in painted walls and ceilings may be visible.

### Skim Coating

The best method to prepare any gypsum drywall surface for painting is to apply a skim coat of joint compound. This leaves a film thick enough to fill imperfections in the joint work, smooth the paper texture and provide a uniform surface for decorating. Skim coating is currently recommended when gloss paints are used. It is also the best technique to use when decorating with flat paints.

---

**Skim Coat  
Application**

Finish joints and fasteners in the conventional three-coat manner. After joints are dry, mix joint compound to a consistency approximating that used for hand taping. Using a trowel, broad knife, or long-nap texture roller, apply only sufficient amounts of joint compound to cover the drywall surface. Then immediately wipe the compound as tightly as possible over the panel surface using a trowel or broad knife. Note: Do not use setting-type joint compound for thin skim coats. If setting-type compound dries before it sets, bond failure may result.

---

**Finishing and  
Decorating Tips**

1. When sanding joint compound applied over joints, fasteners, trim and corner bead, take care to avoid roughening the panel face paper. Any paper roughened during sanding has raised fibers which are conspicuous after painting.
2. All surfaces (including applied joint compound) must be thoroughly dry and dust free before decorating.
3. After conventional finishing of gypsum panel joints and fasteners, apply a skim coat of joint compound over the entire surface. This is the best technique for minimizing surface defects that will show through after painting if critical lighting conditions exist and/or glossy paints are used. Skim coating fills imperfections in joint work, smooths the paper texture and provides a uniform surface for decorating. After skim coat has dried, apply a prime coat of CGC First Coat, SYNKO Pre-Coat for best results.
4. If skim coating is not done, the next best technique for minimizing decorating problems is to apply a prime coat of CGC First Coat, SYNKO Pre-Coat. This paint-like product equalizes joint and wallboard surfaces to help avoid texture or suction variations when the finished paint coats are applied. This procedure minimizes problems with concealment of joints and fasteners.
5. A ceiling or wall texture finish is an excellent method for masking imperfections and diffusing light across wall and ceiling surfaces.
6. Frequent job inspections forestall potential problems and help insure project specifications are being met. Wall and ceiling surfaces should be inspected after the gypsum panels are installed, when the joints are being treated and after the joints are finished before the surface is decorated. These checks will reveal starved and crowned joints which always show up under critical lighting.

# Priming

**Surface Preparation** Proper preparation is essential for producing the best possible painted finish. Surfaces must be dry, clean, sound and free of oil, grease and efflorescence. Glossy surfaces must be dulled. Metal: Exposed metal should be primed with a good rust-inhibitive primer. Concrete: New concrete should age 60 days or more before covering. Fill cracks and level any offsets and voids to the same level as adjacent surfaces with setting-type joint compound. Apply as many coats as are needed to provide a crack-free fill without edge joinings that show through decoration. Exercise special care to provide a smooth surface free of irregularities in areas exposed to sharply angled lighting. Drywall: Treat drywall joints and nailheads with a CGC/SYNKO Brand Joint Treatment System.

Also important for a superior paint job is the equalization of both the porosity and texture of the surface to be painted. The best way to achieve this is to apply SHEETROCK Brand Primer-Surfacer (TUFF-HIDE) or to skim coat the entire surface with CGC/SYNKO Brand All Purpose Ready to use Joint Compound as described above, followed by a prime coat of CGC First Coat, SYNKO Pre-Coat.

## CGC First Coat Application

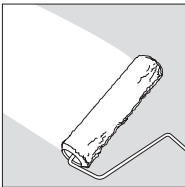

*Specially formulated, fast drying CGC First Coat equalizes surface texture and porosity to minimize decorating problems.*

CGC First Coat is a specially formulated flat latex paint product with exceptionally high solids content that provides a superior first (prime) coat over interior gypsum board.

In contrast to sealers or vapor barrier paints, CGC First Coat does not provide a film that seals the substrate surface. Instead, it minimizes porosity differences by providing a base that equalizes the surface absorption and texture of the substrate to minimize 'joint banding', 'photographing' and other decorating problems. CGC First Coat also provides the proper type and amount of pigments and fillers, that are lacking in many conventional primers and sealers, to equalize the surface textures.

CGC First Coat is designed for fast, low-cost application. It dries to a hard, white finish in less than 30 minutes and can be topcoated within one hour. Not intended as a final coating, it should be overpainted when dry. The product comes ready-mixed in 18.9-L and 3.78-L pails.

**Mixing** Ready-mixed CGC First Coat should be stirred gently. Do not thin for brush or roller application. For spray application, if necessary, add water in 50 mL increments up to a maximum 250 mL of water per litre. May be tinted.

**Application (Walls and Ceilings)** Apply a full coverage coat. Material dries to touch in under 30 min. Maintain minimum air, product mix and surface temperature of 13°C (55°F) during application and until surface is dry. Brush, roller, airless or conventional spray gun may be used.

**Brush** Use a high-quality, professional paint brush.

**Roller** Use a high-quality roller with 3 mm (1/8") to 6 mm (1/4") nap on smooth and semi-smooth surfaces. For any surface, maximum nap length should not exceed 13 mm (1/2").



**Conventional Spray Gun** Use Binks Model 2001 gun, pressurized external, with #565 fluid needle, #66 fluid nozzle and #65 PR air nozzle; or Binks Model 18, pressurized external, with #65 fluid needle, #66 fluid nozzle and #65 PR air nozzle; or Binks model 18, pressurized internal, with #68 fluid needle, #68 fluid nozzle and #206 air nozzle; or Binks Model 18D gun, pressurized internal with #54-1209 fluid needle, #57 fluid nozzle and R-27 air nozzle; or similar equipment. Air hose is typically 9.5 mm (3/8") i.d. with 12.7 mm (1/2") fluid hose i.d.

**Airless Spray Gun** Use professional equipment that meets or exceeds the following when spraying through 15 m (50') of 6.4 mm (1/4") i.d. airless spray hose: output at least 2.8 L per minute; pressure at least (2700 psi); and accommodates a spray tip of 0.5 mm (0.021") at (2000 psi). Recommended equipment includes Graco Ultra 1500, 1000 or 750 models with a suitable spray gun that will accommodate a RAC IV 519 (0.019") or RAC IV 521 (0.021") tip, a RAC IV Dripless Guard, and a 30-mesh filter.

**Note:** Adjust atomizing air pressure and fluid flow rate so that full coverage rate can be achieved by overlapping preceding application with one-quarter to one-half the fan width at a distance of 457 mm (18") from the surface. Air pressures and flow rates will vary with hose size and length and paint consistency.

CGC First Coat contains a high level of select pigments and fillers like conventional latex flat paints. When these paints are used in spray equipment previously used to spray PVA sealers which contain high levels of resin, clogging at the spray gun tip may result. The use of clean or new hoses is recommended to avoid this problem when spraying CGC First Coat.

**Coverage** Approx. 7-12 m<sup>2</sup> per litre of wet-mixed material depending upon factors such as application equipment and technique, condition of the substrate, amount of dilution and thickness and uniformity of coating.

**Adding to Wall and Ceiling Textures** If slightly better spray properties, wet hide, improved bond, whiteness and surface hardness of texture are desired, CGC First Coat may be added to wet-mixed SHEETROCK Brand Wall and Ceiling Textures at a rate of up to 3.78 L CGC First Coat per 20 kg bag of texture. Reduce water quantity to account for addition of CGC First Coat based on 1:1 replacement basis. Surface priming recommendations on texture bag still apply.

---

### **SHEETROCK Brand Primer-Surfacer (TUFF-HIDE)**

SHEETROCK Brand Primer-Surfacer, TUFF-HIDE is a dual-purpose vinyl acrylic latex-based coating designed especially for interior application over new drywall. In a single spray application it provides the same results achieved using a typical two-step process of skim coating surfaces with joint compound followed by a coat of primer. In a GA-214/ASTM C-840 Level 5 gypsum board finish, SHEETROCK Brand Primer-Surfacer, TUFF-HIDE is used in lieu of a skim coat of joint compound and paint primer coat to provide the highest quality drywall finish.

In ceiling applications where a flat white finish is desired, SHEETROCK Brand Primer-Surfacer, TUFF-HIDE can be left unpainted providing an ideal final finish.



Typical Level 5 Finish

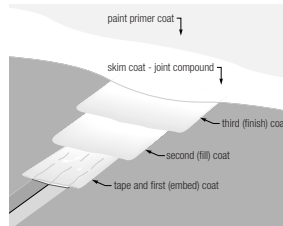

TUFF-HIDE Primer-Surfacer Level 5 Finish

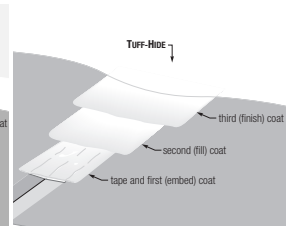

## Surface Preparation

Substrate must be sound, dry, clean and free of oil, grease, mildew and efflorescence. Product, air, and surface temperatures must be maintained at a minimum of 13 °C (55 °F) throughout the finishing process.

**New Drywall**—Treat all joints, fasteners, and accessories with a recommended CGC/SYNKO Joint Treatment System. Fill all nicks, voids, and gouges with joint compound. A minimum Level 4 wallboard finish is recommended. Refer to Gypsum Association publication GA-214, titled; “Recommended Levels of Gypsum Board Finish” or ASTM C-840 equivalent for a detailed description.

**Concrete & Plaster**—Concrete and plaster surfaces should be thoroughly dry before painting. Concrete surfaces should age at least 60 days before finishing. Remove all form oils and efflorescence and grind down form lines. Fill cracks and holes, and level concrete surfaces with Setting-Type Joint Compound.

## Mixing

Stir gently. Use fresh material. Do not thin. Thinning will reduce performance. Do not intermix with any other products. May be tinted with up to 15 mL per litre of universal colourants.

## Application

Airless spray application only. Use professional equipment that meets or exceeds the following rating when spraying through 50 ft. of 1/4" i.d. high-pressure hose: output at least 4 litres (1 US Gal) per minute; pump pressure rated at 2700-3000 psi; and accommodates a 0.031" spray tip at 2000 psi. Graco MARK V, GMax 5900 HD, Ultra Max 1095 and 1595 models are examples of approved airless pumping equipment. Use a 30-mesh filter located in the high-pressure manifold. Use a spray tip orifice between 0.023" to 0.031". It is recommended to use a Graco heavy-duty texture spray gun or equivalent that accommodates a Graco RAC V 527 (0.027"), RAC V 529 (0.029"), or RAC V 531 (0.031") tip.

Test the spray pattern prior to application. To apply, hold spray gun perpendicular to the surface approximately 300 to 450 mm (12 to 18") away. Move the gun parallel to the surface at a steady rate. Lap each stroke approximately 50% over the previous stroke for uniform paint thickness. Spray from left to right to scratch in the initial coat at approximately half of the desired thickness. Then crosshatch spray up and down as the double-up coat to the desired thickness. When painting corners, aim the gun toward the center of the corner to ensure both sides are sprayed evenly. When used in lieu of a skim coat of joint compound and paint primer coat in a Level 5 gypsum board finish, apply to

a minimum Wet Film Thickness (WFT) of 15 mils (0.38 mm). In applications a wet film thickness in excess of 20 mils (0.51 mm) is not recommended. During and after application, avoid drafts and maintain 13 °C (55 °F) minimum product, air and surface temperatures until surface is dry.

**Drying Time** Dries to touch in approximately 60-90 minutes when applied at 15-20 mils WFT (0.38 to 0.51 mm) (9-12 mils DFT) under normal drying conditions (77 °F/50% RH). Let dry before re-coating. High humidity and/or cold temperature will slow drying.

**Coverage** Approximately 100-125 sq. ft. per US gallon (2.5-3 m<sup>2</sup> per litre) when applied at 15-20 mils WFT (9-12 mils DFT). Actual coverage can vary depending on factors such as substrate surface condition, spray techniques, procedures, coating uniformity, and thickness.

**Cleanup** Wipe up drips and spills immediately with damp cloth. Clean tools with warm soapy water. Close container after each use.

**Decorating** May be painted after overnight drying. Follow paint manufacturer's instructions. May be left unpainted.

**Testing:** Tested for abrasion resistance, passing 1000 cycles, in accordance with ASTM D4977 (modified). For additional information on abrasion resistance testing methods and comparative results, refer to Abuse Resistant Systems (SA929). Tested in accordance with ASTM D3450 (washability), and ASTM D2486 (scrubability).

**Material:** Vinyl acrylic latex-based.

**Types:** Spray application only.

**Temperature Sensitivity:** Store in a dry location. Protect from freezing, exposure to extreme heat and direct sunlight.

**Coverage:** Approximately 100-125 ft. per US gallon (2.5-3 m<sup>2</sup> per litre) when applied at 15-20 mils WFT (0.38 to 0.51 mm) (9-12 mils DFT).

**Drying Time:** Approximately 60-90 minutes when applied at 15-20 mils WFT (0.38 to 0.51 mm) (9-12 mils DFT) under normal drying conditions (77 °F/50% RH).

**Storage:** Store at room temperature in a dry location.

**Packaging:** 5 US gallon pail (18.9 L).

## Concrete Coating Application

### COVER COAT Levelling Compound

CGC COVER COAT is a premium grade, aggregated powder formulation for filling and smoothing monolithic interior concrete ceilings and columns located above grade. It is easily applied directly over concrete and masonry surfaces—no bonding agent is required. Features minimum drying shrinkage and excellent bond and crack resistance.

### SYNKO CONCRETE SEAL

Designed to be trowelled over sound and dry interior concrete without the need for bonding agents. CONCRETE SEAL levels and seals concrete prior to the application of SYNKO texture spray.

**Surface Preparation:** All surfaces must be clean, dry, and sound. Remove all loose dirt, dust, grease, form-oil, parting compounds, cracked and scaling paint, and other contaminants. Grind down fins and other projections, remove lumps and ridges, and dust surface clean. Patch any large holes with DURABOND 90 or CONCRETE FILL or by spot application of COVER COAT prior to finish coat application. Coat metal surfaces with rust preventative paint and allow to dry thoroughly.

**Mixing:** Use drinkable water and clean mixing equipment. Sift 15 kg (1 bag) of powder into 12 litres of water for trowel application, or 23 litres of water for spray application. Let soak for 15 minutes, remix to creamy consistency and use. Consistency may be adjusted by adding small amounts of water. Do not overthin.

**Application:** May be hand troweled or spray applied. Maintain 12 °C temperature during and after application until building is occupied. Provide adequate ventilation for proper drying. Do not use unvented gas or oil heaters. If more than one coat applied, allow each coat to dry thoroughly before applying subsequent coats. For spray application use spray-gun with large surface nozzle set at low atomizing pressure.

**Coverage:** Trowel: 8 m<sup>2</sup> (86 ft<sup>2</sup>)/15 kg at 3 mm (1/8") thickness. Spray: 14 m<sup>2</sup> (150 ft<sup>2</sup>)/15 kg at 3 mm (1/8") thickness. Coverage may vary depending on surface characteristics, depth of fill, and method of application.

**Care of Equipment and Storage:** Clean all equipment after use. Remove residues and partially dry material from tools. Store in a dry place. Close open bags as airtight as possible.

**Painting and Decorating:** May be left as a texture finish or over-sprayed with standard spray textures. Follow painting and decoration instructions of appropriate manufacturers for overpainting.

**Basic Cautions:** Do not apply drywall tape to levelling compounds at ceiling-partition interface. Taping must be to the concrete surface otherwise bond failure may occur.

- Excessive water usage causes check cracking, poor bond, lack of hide.
- Do not intermix with other compounds in wet or dry form.
- Do not apply over moist surfaces (or surfaces likely to become moist by condensation or otherwise), on ceiling areas below grade, on exterior surfaces or other areas subject to moisture, freezing, effervescence, pitting or popping, or other abnormal conditions.
- Maintain minimum air, water, mix, and surface temperatures of 12 °C (55 °F) within working areas during application.
- Do not exceed recommended coverage.

---

## SYNKO CONCRETE FILL

SYNKO CONCRETE FILL is a quick setting fiberglass setting-type joint compound. Designed to fill deep voids or cracks in interior masonry walls and ceilings.

---

## CGC Setting-Type Joint Compounds

CGC DURABOND or CGC SHEETROCK setting-type compounds are equally suitable for filling form offsets and voids left in interior concrete. These Joint Compounds should not be applied over moist surfaces or surfaces subject to moisture, or any abnormal condition.

---

### Application

Grind off high plane differences in concrete level with adjacent area; remove any form oil, efflorescence or greasy deposits.

Prime exposed metal with a good rust-inhibitive primer.

Mix CONCRETE FILL or CGC setting-type compounds according to bag directions.

Use compound to fill cracks and holes and level any offsets and voids to the same level as adjacent surfaces. Apply as many coats as are needed to provide a crack-free fill without edge joinings that show through decoration. Exercise special care to provide a smooth surface, free of irregularities in areas that will be exposed to sharply angled lighting.

Apply additional coats as required after each coat has set, but not necessarily dried.

Apply a thick skim coat of CGC DURABOND or SHEETROCK setting-type joint compound over entire surface. Skim coat must be thick enough to prevent dryout before setting, or bond failure may result. If an easier-sanding surface is desired, apply final skim coat of CGC/SYNKO Ready-Mixed Joint Compound instead of CGC DURABOND setting-type compound.

Before decorating with paint or texture, apply coat of CGC First Coat or a good quality, undiluted interior latex flat wall paint over entire surface and allow to dry.

For textured ceiling, apply CGC/SYNKO Texture Spray in uniform coat.

## Sealant Application (Caulking)

If gypsum board assemblies are to effectively reduce the transmission of sound, they must be airtight at all points. To achieve this, perimeters must be sealed with a caulking material that remains resilient. Also, penetrations for electrical outlets, medicine cabinets, plumbing, heating and air-conditioning ducts, telephone and intercom hookups and television antenna outlets must be effectively sealed. (Sealant is not to be used as a fire stopping material for through-penetrations and head-of-wall construction joints.)

Sealing or caulking for sound-control is so important that it must be covered in the specifications, understood by the workers of all related trades, supervised by the foremen, and inspected carefully during construction.

Acoustical sealant application has proven to be the least expensive, most cost effective way to seal assemblies and prevent sound leaks. However, sealant is not intended for use as a fire stopping material for through penetrations and head-of-wall construction joints.

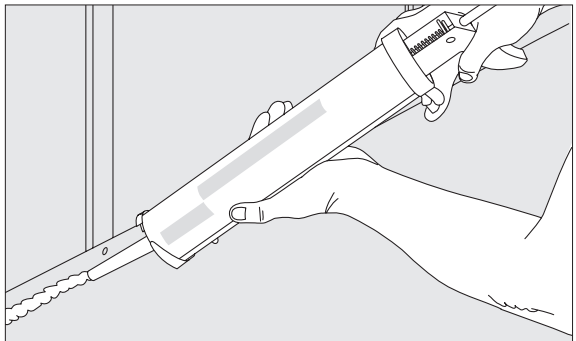

Proper caulking of outlet box (left), and double-layer partition (right).

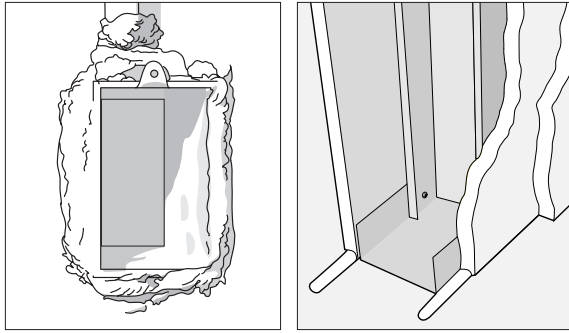

Sealant applied around pipes and ducts effectively seals the wall to reduce sound transmission. Note: Sealant is not to be used as a fire stopping material for through penetrations and head-of-wall construction joints.

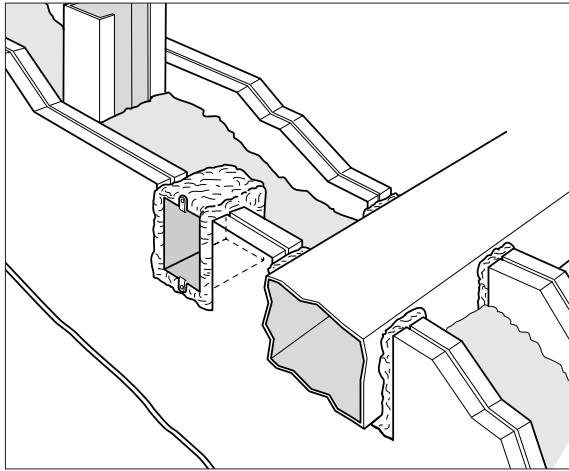

Tests conducted at the USG Research Center demonstrate that reliability of the perimeter seal is increased if perimeter relief does not exceed 3 mm (1/8"). When such a gap, around the base-layer perimeter, is caulked with a 6 mm (1/4") bead of sealant, installation of face panels compresses the sealant into firm contact with all adjacent surfaces to form a permanent airtight seal.

To be effective, sealant must be properly placed. Placement is as important as the amount used. The technical drawings below indicate correct and incorrect applications of acoustical sealant.

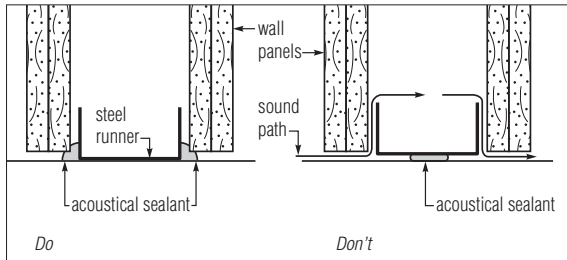

The assemblies tested consisted of 64 mm (2-1/2") steel studs 24 o.c., double-layer SHEETROCK Brand Gypsum Panels each side; and 38 mm (1-1/2") THERMAFIBER Sound Attenuation Blankets between studs. Results of sealant conditions are shown below.

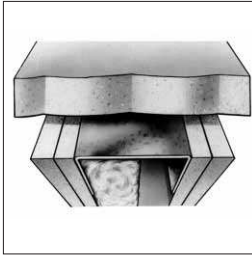

29 STC Unsealed

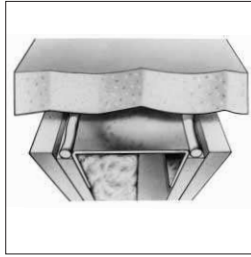

53 STC Both base layers sealed.  
No relief on face layers.

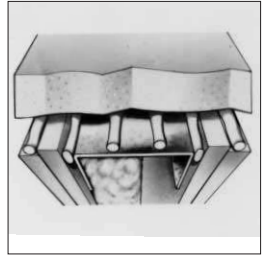

53 STC Sealed beneath and on  
edge of runner track. Base layer not  
relieved. Face layer relieved and  
sealed.

## Installation

**Partition Perimeter** Cut gypsum boards for loose fit around partition perimeter. Leave a space no more than 3 mm (1/8") wide. Apply a 6 mm (1/4") min. round bead of sealant to each leg of runners, including those used at partition intersections with dissimilar wall construction. Immediately install boards, squeezing sealant into firm contact with adjacent surfaces. Fasten boards in normal manner. Gypsum panels may have joint treatment applied in normal manner over sealed joints, and gypsum base may be finished normally with veneer plaster. Or, panels may be finished with base or trim as desired.

For caulking application with metal trim over edge of boards where boards intersect dissimilar materials or cracking due to structural movement is anticipated, refer to "Perimeter Isolation" section on page 128.

**Control Joints** Apply sealant beneath control joint to reduce path for sound transmission through joint.

**Partition Intersections** Seal intersections with sound-isolating partitions that are extended to reduce sound flanking paths.

**Openings** Apply sealant around all cutouts such as at electrical boxes, plumbing, medicine cabinets, heating ducts and cold air returns to seal the opening. Caulk sides and backs of electrical boxes to seal them. (Sealant is not to be used as a fire stopping material.)

**Door Frames** Apply a bead of sealant in the door frame just before inserting face panel.

Details—  
use of  
Acoustical Sealant

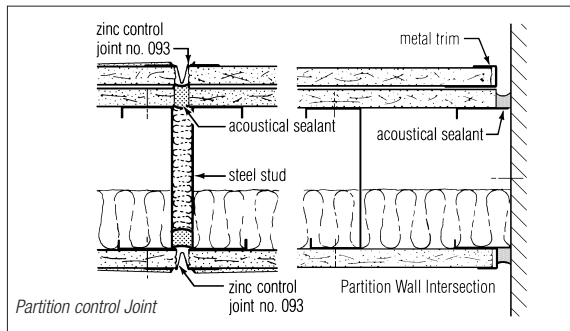
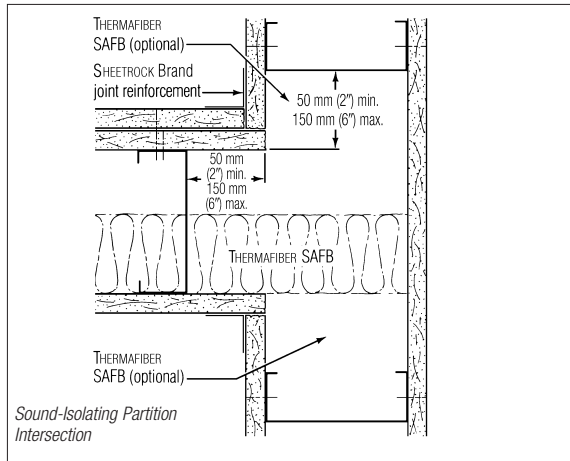
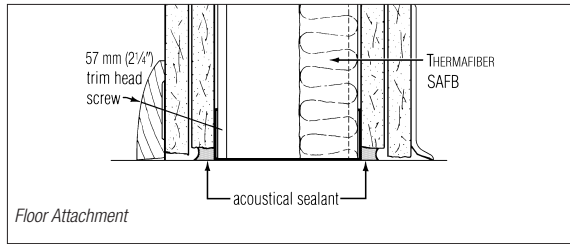
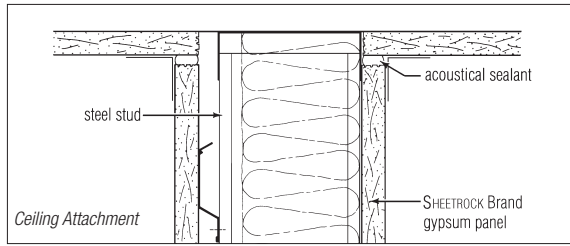



Details—  
use of Acoustical  
Sealant (continued)

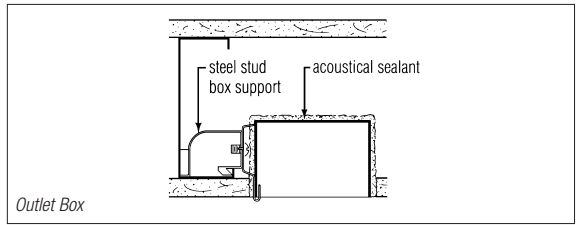

## Texture Finish Application

Textured finishes for gypsum board surfaces are desired for their decorative beauty and ability to obscure minor surface imperfections with economical spray application. CGC offers a full line of products to create medium and coarse simulated acoustic texture finishes, as well as sand finishes. Interesting wall patterns can be created by using texture finish products with stipple brushes, pattern devices, rollers, floats, trowels and finishing knives.

**Note:** Textured surfaces also can be created with veneer plaster finishes. See veneer application section in Chapter 6.

- |                    |  |
|--------------------|--|
| <b>General</b>     | 1. Not recommended below grade or in high-humidity areas.  |
| <b>Limitations</b> | 2. Heavy, water-based texturing materials may cause sag in gypsum panel ceilings under the following adverse conditions: high humidity, improper ventilation, panels applied parallel to framing and panels having insufficient thickness to span the distance between framing. The following table gives max. framing spacing for panels that are to be covered with water-based texturing materials. |

### Frame Spacing—Textured Gypsum Panel Ceilings

Board Thickness		Application Method (long edge relative to frame)	Max. Framing Spacing o.c.	
mm	in.		mm	in.
9.5	3/8	not recommended	—	—
12.7	1/2	perpendicular only	400	16
12.7*	1/2*	perpendicular or parallel*	600*	24*
15.9	5/8	perpendicular only	600	24

\* 12.7 mm (1/2") SHEETROCK Brand Interior Gypsum Ceiling Board provides the strength and sag resistance of 15.9 mm (5/8") standard board without the added thickness. Note: For adhesively laminated double-layer applications with 19 mm (3/4") or more total thickness, 24 o.c. max.

- The following surface preparation directions apply to new drywall and concrete surfaces. When redecorating an old, existing surface with a water-based texture, migrating stains or contaminants from the substrate may leach to the finished surface, resulting in discoloration and staining. See preparation directions for 'Redecorating Ceilings' on pages 193-195 for more information on the proper surface preparation of existing surfaces prior to redecorating with a water-based texture.

See "Ceiling Sag Precautions" on page 321 for more information on the application of water-based textures and interior finishing materials.

## Preparation

All surfaces must be dry, clean and sound. Dull glossy surfaces. Metal: Prime metal with a good rust inhibitive primer. Wood: Fill and seal surfaces. New concrete: Age 60 days or more before covering; remove form oils, grease, efflorescence; grind down plane differences and remove grinding dust and sludge; fill cracks and holes and level any offsets and voids to the same level as adjacent surfaces with CGC COVER COAT, CGC DURABOND, SHEETROCK setting-type compound or SYNKO CONCRETE FILL or CONCRETE SEAL. Apply as many coats as are needed to provide a crack-free fill without edge joinings that show through decoration. Exercise special care to provide a smooth surface free of irregularities in areas that will be exposed to sharply angled light. New drywall: reinforce and conceal drywall joints using CGC or SYNKO Brand Joint Tape and a CGC/SYNKO Brand joint compound; fill all fastener depressions with joint compound; smooth surface scratches and scuffs. Correct plane irregularities, as these are accentuated by sharp, angular lighting.

When prepared surfaces are dry and free of dust, apply a prime coat of CGC FIRST COAT, SYNKO PRE-COAT. This product equalizes porosity variations between the gypsum board face paper and the finished joints, minimizing decorating problems such as "joint banding." As a less effective substitute, a good quality, white, interior latex flat wall paint with high solids content may be used. Apply undiluted and allow to dry before decorating.

**Note:** Application of a prime coat is to equalize the surface porosity and to provide a uniform color. Primers are not intended to reduce sag potential or to prevent migrating stains or contaminants from leaching to the finished surface.

**Note:** For redecorating old ceilings, see pages 193-195 for proper surface preparation and application of decorating materials.

## Powder Texture Finishes

**CGC SHEETROCK  
medium or coarse  
finish, SYNKO RUFF-TEX  
or SYNKO SNOW-TEX  
(aggregated)**

**Mixing** Use clean vessel equipped with variable-speed power agitator. Sift texture finish into the recommended amount of water, agitating water during powder addition. Allow to soak for at least 15 min.—longer in cold water. Remix until a creamy (but aggregated) lump-free mix is obtained. Adjust spray consistency by adding small amounts of powder or water. Do not overthin, as poor adhesion, lack of hide and texture variation may result.

**Equipment** Use professional spray equipment such as a 10-to-1 ratio, double-action piston pump with 191 mm (7-1/2-in.) stroke, equipped with 1220 mm (4-ft.) pole gun having 9.5- to 12.7-mm (3/8- to 1/2-in.) round orifice, or Binks 7E2 or equivalent hand gun with 9.5 mm (3/8-in.) round opening. Use 19 mm (3/4-in.) to 25 mm (1-in.) material hose, 9.5 mm (3/8-in.) atomizing hose and 12.7 mm (1/2-in.) air line from compressor to pump; or rotor-stator pump (L3 or L4) with 8 mm (5/16") to 9.5 mm (3/8") round orifice. Compressor must be adequate for length and size of hose. Keep pressure as low as possible. Plaster mixers or hopper-type applicators also may be used.

**Application** Apply at rate up to 1 to 1.6 m<sup>2</sup> per kg. Do not exceed recommended coverage, as subsurface defects, variations in base suction or color differences may show through, or lighter texture may result.

Surfaces with uneven suction may require two coats. Let first coat dry before applying second. Remove splatters immediately from woodwork and trim. Maintain 13°C (55°F) minimum air, water, product mix and surface temperature of the substrate during application and until surface is dry. Not washable, but can be painted (spray application is recommended) when redecoration is needed.

---

**SYNKO SPAN-TEXTURE  
Non-Aggregated  
Walls and Ceilings  
Texture**

**Application** Apply by machine or hand to create the desired effect. Application rates will vary depending on the texture pattern of choice. Generally, apply at 2 m<sup>2</sup> (22 ft.<sup>2</sup>) per kg for crowsfoot, swirl and stipple patterns; (20-40 ft<sup>2</sup>/lb.) for orange peel pattern; and 2-5 m<sup>2</sup> (22-55 ft.<sup>2</sup>) per kg for spatter and knockdown patterns. Maintain 13°C (55°F) minimum air, water, product mix and surface temperature during application and until surface is dry. Avoid drafts while applying product but provide ventilation after application to aid drying. Do not use unvented gas or oil heaters. May be painted after overnight drying. Not washable unpainted.

## Ready-Mixed Texture Finish

### READY-TEX, SYNKO SPAN-LITE Walls and Ceilings Texture

**Product Preparation** Use a heavy-duty drill fitted with a suitable mixing paddle and operate it at 400-600 rpm. Excessive or high-speed mixing may produce voids in finished appearance. Mix until consistency is smooth and uniform. Do not mix with other materials in wet or dry form.

**Thinning** Thinning of texture with water will vary considerably, depending on the finished appearance desired and the method of application to be employed. Applicator should experiment with some of the mixed material prior to use, then adjust water proportions to suit the job. Overthinning may cause poor bond, pinholes and cracking.

**Coverage** Up to 37 m<sup>2</sup> (400 ft<sup>2</sup>) per carton is an estimate. Actual coverage will vary depending on factors such as the type of texture design, the condition of the substrate surface, the amount of dilution of the product, application technique, and the uniformity of the coating.

**Application** Apply with brush, roller or with suitable professional spray equipment. For spray application, spray using a 16-in. to 20-in. fan. Overlap preceding application with 1/2 to 2/3 of fan, applying first in one direction and then in cross direction. Texture must be evenly spread and free from runs, sags and other blemishes. Allow texture to dry before applying paint. Maintain 55° F minimum air, texture and surface temperatures within working area until texture is completely dry. Texture colour may not match colour of other texture products. May be painted after overnight drying. Not washable unpainted.

## Creating Texture Patterns

READY-TEX, SYNKO, SPAN-LITE and SPAN-TEXTURE offer opportunities for a variety of patterns and appearances. The number of patterns that can be created is limitless, but several patterns are particularly popular. Here are some commonly used patterns and information about how to achieve them.

### Spatter and Light Orange Peel



#### Application Spray

**Equipment** Binks 7D gun or equivalent, equipped with a #57 fluid nozzle and A-27 fan cap.

**Procedure** Mix products to a thin, latex-paint consistency. For a light orange peel, which is always the first application, atomizing air should be approximately 60 psi and material feed pressure approx. half the atomizing pressure. When spraying, apply in long even strokes with no wrist action, holding gun perpendicular to surface and approx. 450 mm (18 in.) from surface. Apply material as uniformly as possible avoiding lap marks.

**Spatter Coat** After fog coat has been applied, allow about 10-15 min. for surface to partially dry, then apply spattering by removing the A-27 fan cap and reducing atomizing air to approx. 15 psi and material feed to approx. 10 psi. While applying spatter coat, move spray gun in a rapid random fashion standing about 1800 mm (6 ft.) from surface. Size of spatters depends on pressures used. Amount (or density) of spatters on surface depends on personal preference.

---

### Orange Peel



### Application

**Spray**  
**Equipment** Same as for light orange peel except atomizing air pressure should be approximately 40 psi and material feed pressure approx. 20 psi. Degree of orange peel pattern depends on amount of material applied to surface.

---

### Knock-Down and Skip-Trowel



### Application

**Spray**  
**Equipment** Pole gun, hopper, or Binks 7D or Binks 7E2 gun

**Knock-Down Procedure** Apply as spatter as described except use material at heavy latex-paint consistency. After spattering surface, wait about 10-15 min., then very lightly flatten only tops of spatters with flat blade or flat hand trowel. Again, size of spatters depends on pressures used.

**Skip-Trowel Procedure** Mix in #30 mesh silica sand (125 mL silica sand/litre of texture). Apply as spatter coat but at very low pressures to allow for large spatters on surface. Wait approx. 10 to 15 min., then use blade as in the knock-down procedure, but applying more pressure.

---

### Stipple Texture

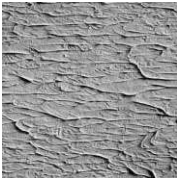

### Application

**Hand**  
**Equipment** Paint pan or large pail, paint roller 6 to 25 mm (1/4-in. to 1-in.) nap. Short nap produces lower stipple—fine pattern. Long nap produces higher stipple—coarse pattern.

**Procedure for Hand Texturing** Mix product to a consistency similar to spatter/knockdown. Completely wet out roller with material, then apply to surface as evenly as possible, covering entire surface. Let partially dry to a “dull wet” appearance, then roll again for desired texture effect.

**Crow's Foot**

Use same material, equipment and application as for stipple texture, then use texture brush instead of paint roller to texture surface.

Procedure is the same as for roller texture, except that after material has partially dried to dull wet finish, stamp surface with texture brush prewetted with texture material for desired stipple finish.

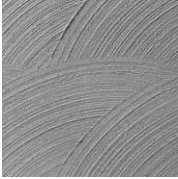
**Swirl Finish****Application Hand**

**Equipment** Same as for stipple texture, plus wallpaper-type brush.

**Procedure** Apply as a roller texture. Let surface dry to dull wet finish, then use wallpaper brush to achieve desired swirl texture, rotating brush in circular motion on the wet surface.

**Other Hand Textured Effects**

Textured effects cited above are only a few of the many imaginative textures possible. Other effects can be achieved using different texturing tools.

A string-wrapped roller produces an attractive striated stone effect while cross-rolling gives an additional interesting squared pattern. For finer designs and textures, use a small brush, roller-stippler, whisk broom, crumpled paper, comb, sponge or similar items. Flattening raised portions of wet material or sanding when dry provides further variations. Material also may be scored to represent block, tile or cut stone outlines.

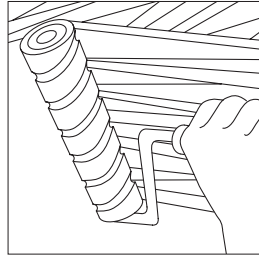
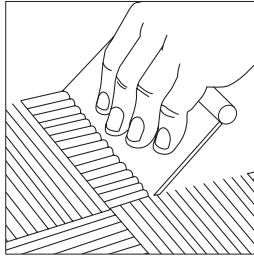
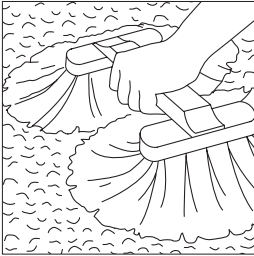

## Resurfacing

Where ceilings or sidewalls are so badly disfigured that an entirely fresh surface is desirable, they may be resurfaced using a layer of 6.4 mm (1/4") or 9.5 mm (3/8") SHEETROCK Brand Gypsum Panels. Ceilings may also be redecorated with texture finishes. For resurfacing masonry walls, see application of gypsum board to wall furring, described in Chapter 3.

**Preparation** Remove all trim (this may not be necessary if 6.4 mm (1/4") panels are used). To remove trim easily, drive all nails completely through the trim with a pin punch. Remove all loose surfacing material. Fill small holes with joint compound or patching plaster. Patch large holes to the surrounding level with single or multiple layers of gypsum board nailed to framing and shimmed out as required.

Electrical outlet boxes for switches, wall receptacles and fixtures should be extended outward to compensate for the added gypsum panel thickness.

Locate joists and studs by probing or with a magnetic “stud finder.” Snap a chalk line to mark their full length and mark their location on the adjacent wall or ceiling. Where great irregularities of surface exist, apply furring strips not over 406 mm (16”) o.c., using wood shingles to shim out to a true, even plane.

**Installation** Apply SHEETROCK Brand Gypsum Panels with long dimension placed horizontally or vertically. Fasten with gypsum board nails or drywall screws, spaced 178 mm (7”) o.c. on ceilings, 203 mm (8”) o.c. on walls. Nails or screws must be long enough to penetrate into framing members at least 15.9 mm (5/8”).

Gypsum panels may be adhesively applied over sound, existing walls with Setting-Type Lightweight Setting-Type Joint Compound.

Finish SHEETROCK Brand Panels with metal corner reinforcement and joint treatment as necessary, and replace all trim.

## Redecorating Ceilings

Redecorating cracked, discolored or damaged ceilings with texture can make old ceilings look like new. Spray-applied texture finishes cover minor surface cracks and imperfections and provide beautiful surfaces. Redecorating surfaces previously decorated with a large-aggregate texture is especially effective since these surfaces normally are not easily cleaned, rolled or brush-painted. Yet they are easily spray-painted with texture. These modernized ceilings add value and beauty. Best of all, most jobs can be done in one day without removing rugs, furniture or light fixtures.

**Preparation** Surface cracks larger than hairline size should be treated with a drywall joint compound and tape, and thoroughly dried, prior to redecorating. Tobacco smoke stains require predecoration attention and treatment with a special stain-blocking sealer. Remove grease stains using mild detergent. Seal water-stained surfaces with primer specifically recommended by the manufacturer. Remove soot or dirt by “air dusting” surfaces.

**Redecorating with Texture**

**Painted Surfaces** Ceilings that have been painted with pastel flat alkyd or latex flat paints can be sprayed with no special pretreatment if free of grease, dirt, smoke stains or other contaminants. Glossy surfaces must be dulled by lightly sanding to develop "tooth" for good bond. Wash surface with a strong solution of TSP (tri-sodium phosphate). Stained surfaces require application of a stain-blocking sealer. Spot prime bare metal with a good rust-inhibitive primer. After prepared surfaces have thoroughly dried, apply SHEETROCK First Coat.

**Previously Textured Surfaces** Priming a ceiling previously decorated with a large-aggregate texture with a paint primer is not necessary if the surface is not stained and is free of grease, dirt, smoke stains or other contaminants. Use only CGC/SYNKO (coarse aggregate) to redecorate an aggregated texture surface.

**Wallpaper or Vinyl Wall Covering** Remove material and prime ceiling surface with appropriate primer prior to texturing.

**Plaster Ceilings** Surface must be in paintable condition. Prior to texturing, cover with primer-sealer specifically recommended by paint manufacturer.

Mask surfaces by covering floors and walls with 0.85 to 1-mil-thick polyethylene sheeting, available in 2440 to 3660 mm (8 to 12-ft.) widths, folded and rolled in half for easier handling. Spread polyethylene sheeting on floor, making sure that all areas are completely covered. Next, apply wide masking tape to wall-ceiling intersection, fastening only top of tape to wall and leaving bottom hanging free. Fasten one edge of folded poly sheeting to loose edge of tape, then unfold film to full width. Press tape into firm contact with both wall and sheeting.

**Cover Furniture, Cabinets, Light Fixtures** Anything that will remain in the room during spraying operation. Lower ceiling light fixtures so they can be quickly and completely covered.

For information on mixing, equipment and application, see pages 188-189.

**Equipment** Use professional spray equipment such as a hand-held hopper or 10:1 ratio, double-action piston pump with 7-1/2-in. stroke, equipped with 1220 mm (4-ft.) pole gun having 9.5 to 12.7 mm (3/8 to 1/2-in.) round orifice, or Binks 7E2 hand gun or equivalent with 9.5 mm (3/8-in.) round opening. Use 19 to 25 mm (3/4 to 1-in.) material hose, 9.5 mm (3/8-in.) atomizing hose and 12.7 mm (1/2-in.) air line from compressor to pump. Compressor must be adequate (85 cfm) for length and size of hose. Keep pressure as low as possible. Plaster mixers or hopper-type applicators also may be used.

**Application** Apply CGC/SYNKO Ceiling Spray at a rate of up to 2 m<sup>2</sup> (22 ft<sup>2</sup>) per kg. Do not exceed recommended coverage, as subsurface defects, variations in base suction or color differences may show through, or lighter texture may result. Maintain 13°C (55°F) minimum air and surface temperature during application and until surface is dry.



---

**Redecorating  
an Aggregated  
Textured Surface  
with Paint**

After properly preparing the surface as described on pages 193-195, redecorate a previously aggregated textured surface with paint following the guidelines below.

Brush application of paint over an aggregated textured ceiling is not recommended. Spray application is preferred. In redecorating by hand, use a long-nap paint roller with 13 to 19 mm (1/2 to 3/4-in.) nap. Any good-quality interior latex or vinyl acrylic paint in flat, egg-shell, SYNKO Texture Fresh or semigloss can be used. Slight dilution of paints with water, particularly high-viscosity types, may be necessary for smoother, easier spreading. Apply paint by rolling in one direction, immediately followed by cross rolling. Use light pressure and avoid over-rolling and saturating the surface to minimize loosening of surface aggregate.

Whether spraying or rolling, avoid drafts while applying, but provide adequate circulation and ventilation to aid drying.

---

**Precautions**

Ventilate or use a dust collector to avoid creating dust in the workplace. A NIOSH-approved respirator should be used if the air is dusty. The use of safety glasses is recommended. Do not take internally. Keep out of reach of children.

