

Conventional Plaster Application

**8**

General Planning Procedures

Two ingredients are required for a quality plaster job—quality products and skilled craftsmen employing correct lathing and plastering procedures.

CGC plaster bases, plasters and plastering accessories are top quality, job-proven products designed to work together. But without proper planning and correct installation by the contractor, these products cannot be expected to produce the desired results.

This chapter deals with the basic recommendations and installation procedures to follow in completing the best possible job. It describes wood and steel framing, applications of conventional plaster bases in fire and sound-rated assemblies, and includes frame-spacing and fastener-selector charts.

Various organizations provide information about recommended standards or tolerances for installation of plaster products and systems. See pages 435 and 442 in the Appendix for information about standards and tolerances.

For instructions on the safe use of plaster and related products, see Chapter 13, Safety Considerations, Material Handling.

Good lathing and plastering practices can give the contractor (1) greater profit through fewer callbacks, less waste and lower job costs, and (2) high quality results that produce quicker sales and a favorable business reputation.

Planning the Job

Advance planning by the plastering contractor can mean savings in time and materials cost and a better-appearing job.

Two areas of planning deserve special attention. In high-rise work it is essential to determine availability and charges for use of hoisting equipment on the job well in advance of the time when it will be needed. Failure to do so can result in costly delays while the hoist is tied up by other trades.

In all types of jobs it is wise to plan for clean-up as the work proceeds, not when the job is finished. Contractors who have adopted this practice affirm that it reduces job costs. They have discovered that it is easier, faster and cheaper to remove drop cloths of roofing paper than to scrape up set plaster. And stuffing electrical boxes with paper before plastering begins is far less costly than digging out set plaster when they are accidentally filled. When machines are shut down, they should be hosed off and thoroughly cleaned—made ready for a fresh start. The benefits from these good working practices add up to faster completions, less down time and equipment maintenance, and more profit.

Estimating Materials

Accurate take-off and estimating quantities of materials are an essential part of job planning. Underestimating causes expensive job delays while quantities are refigured and orders placed. Overestimating invariably results in damage or loss of at least part of the surplus materials.

The tables in Chapter 7 contain data needed for accurate estimating: packaging, coverage of various cementitious materials, and number of accessories needed per area of finished surface. Similar data on steel studs, runners and screws can be found in Chapter 1.

General Job Conditions

Handling and Storage

All successful plaster jobs require adequate equipment: power mixers, mortar boards, scaffolding and tools. Ample scaffolding should be provided to permit continuous application of both basecoat and finish plasters for a complete section of wall or ceiling. Obtain clean water for washing all mixing tools.

Lath and plaster products should be ordered for delivery to the job just prior to application. Materials stored on the job for longer periods are liable to damage and abuse.

Rather than ship all plaster to the job at one time, fresh plaster should be delivered as needed. Plaster stored for long periods is subject to variable moisture conditions and aging that can produce variations in setting time and performance problems.

Store plastering products inside, in a dry location and away from heavy-traffic areas. Stack plaster bags on planks or platforms away from damp floors and walls. Store gypsum plaster bases flat on a clean dry floor; vertical storage may damage edges or deform board. Protect metal corner beads, casing beads and trim from being bent or damaged. All materials used on the job should remain in their wrappings or containers until used.

Warehouse stocks of plaster products should be rotated to assure a supply of fresh materials and to prevent damage to plaster through aging and contact with moisture.

Environmental Conditions

1. When outdoor temperatures are less than 13°C (55°F), the temperature of the building must be maintained in the uniform range of 13° to 21°C (55° to 70°F) both day and night for an adequate period prior to the erection of gypsum plaster base, the application of plaster, while the plastering is being done, and until the plaster is dry. The heat should be well distributed in all areas, with deflection or protective screens used to prevent concentrated or irregular heat on plaster areas near the source.
2. Ventilation must be provided to properly dry the plaster during and subsequent to its application. In glazed buildings, this should be accomplished by keeping windows open sufficiently to provide air circulation; in areas lacking normal ventilation, moisture-laden air must be mechanically removed.
3. To develop proper performance characteristics, the drying rate of plastering materials must be strictly controlled during and after application. Plaster should not be allowed to dry too slowly or too fast. If possible, maintain building temperature-humidity combination in the "normal drying" area of the graph on next page. Excessive ventilation or air movement should be avoided to allow plaster to properly set.

Plaster Drying Conditions

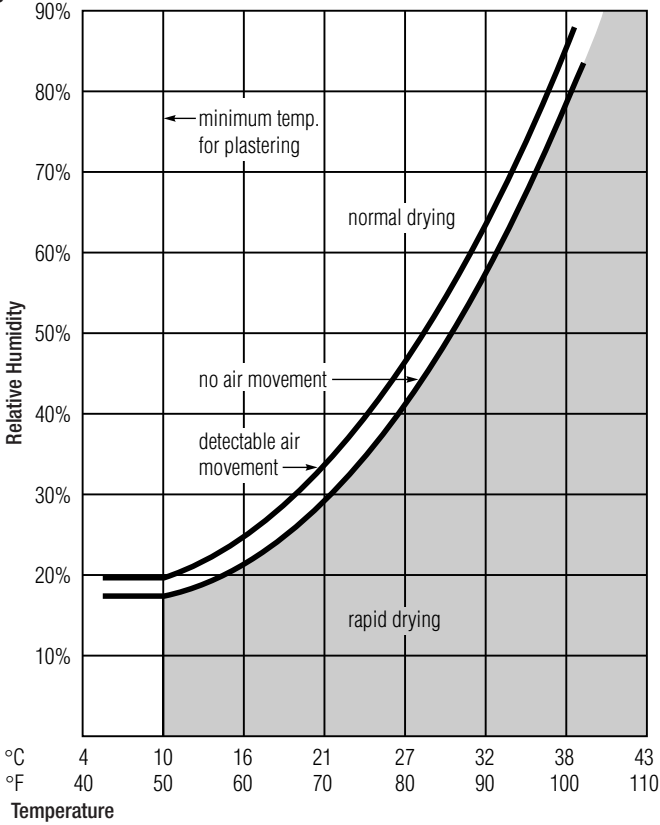

Framing Installation

Requirements for framing with wood and steel studs are the same for plaster and drywall construction and are covered in Chapter 2 of this Handbook. Maximum frame spacing for plaster base is as follows:

Frame Spacing—Gypsum Base (Ceilings & Sidewalls)

Type Framing	Base Thickness		Max. Frame Spacing o.c.	
	mm	in.	mm	in.
Wood	9.5	3/8	400	16
Steel Stud	9.5	3/8	400	16
	9.5	3/8	600	24 ⁽¹⁾
19 mm (3/4") Channel Metal Furring	9.5	3/8	400	16
	9.5	3/8	400	16

(1) Three-coat plastering.

Reinforcing

Openings in a gypsum lath-and-plaster system, such as door frames, borrowed lights, etc., cause a concentration of stresses in the plaster, typically at intersection of head and jamb. The use of additional reinforcement (channels, runners, Striplath, self-furring diamond mesh lath) can be used at the weakened area to distribute concentrated stresses.

Wood or metal inserts used as reinforcing or for attachment of cabinets and shelving on nonresilient surfaces should always be applied behind the plaster base to prevent unnecessary damage to the plaster surface. Heavy fixtures such as water closets and lavatories should be supported by separate carriers and not by the lath and plaster surface. (See page 265 and "Fixture Attachment" in Appendix.)

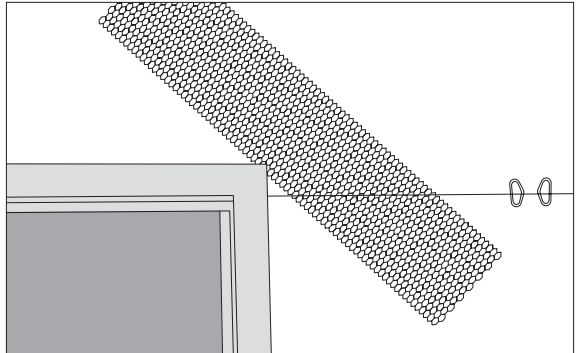

Reinforcing at door

Wall Furring

Exterior wall furring provides a way of spacing the plaster base and plaster away from masonry walls to produce an air space, a chase for services and space for insulation. By furring, uneven walls can be changed to true, even surfaces. Plaster base can be quickly attached, and the uniform plaster base saves plastering material and labor.

Exterior masonry walls should be furred out and a vapor retarder provided if necessary. Several systems are available; each provides structural and cost advantages for special furring conditions.

A properly designed wall furring system should provide:

1. Protection from moisture seepage.
2. Insulation and vapor retarder.
3. Some isolation from structural movement. Exterior walls are subject constantly to changing dimensions due to temperature changes and wind loads.

Wood Strip— GRAND PRIX Plaster Base furring

For masonry wall furring, GRAND PRIX Plaster Base and gypsum plaster over wood furring strips is an economical assembly. The wood furring is usually 19 x 38 mm (1" x 2") or 38 x 38 mm (2" x 2") strips spaced 400 mm (16") o.c. for 9.5 mm (3/8") lath, 600 mm (24") o.c. max. for 12.7 mm (1/2") lath. Apply furring vertically and securely attach to the masonry. If necessary, use small wooden wedges to shim strips to a plumb surface.

Wood furring—
direct attachment

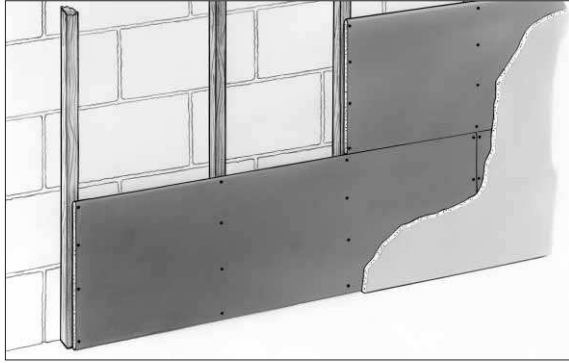

Steel stud—
free-standing furring

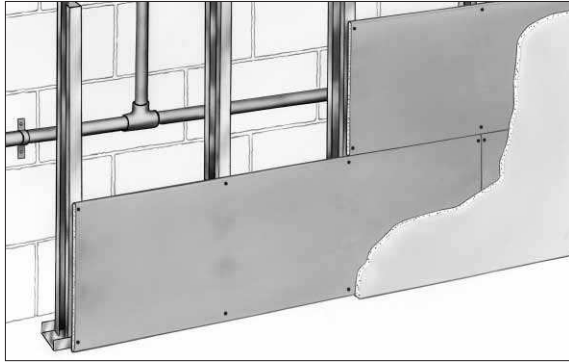

Installation Apply 400 x 1220 mm (16" x 48") GRAND PRIX Plaster Base at right angles to furring strips with end joints occurring between strips using 25 mm (1") nails. When GRAND PRIX Plaster Base has been installed, reinforce inside corners with Cornerite.

**Steel Stud—
GRAND PRIX Plaster
Base Furring**

This free-standing furring assembly consists of GRAND PRIX Plaster Base screw-attached to steel studs and finished with gypsum plaster. The assembly offers a maximum of free space for encasing pipes, ducts or conduits.

With a 6-mil polyethylene film installed under the GRAND PRIX Plaster Base, the assembly provides an effective vapor retarder.

Installation Align floor and ceiling runners parallel to wall and positioned to provide required chase space. Attach to concrete slabs with concrete stub nails or power-driven anchors 600 mm (24") o.c., to suspended ceilings with toggle bolts or hollow metal fasteners 400 mm (16") o.c., or to wood framing with 32 mm (1-1/4") Type W screws 400 mm (16") o.c.

Studs should be selected to limit deflection to L/360 and satisfy applicable stress criteria. Position steel studs vertically in runners, 400 mm (16") o.c. for 9.5 mm (3/8") lath, with all flanges in same direction. The recommended practice for most installations is to anchor only those studs adjacent to door and borrowed light frames. This would also be applicable to partition intersections and corners. In cases where a

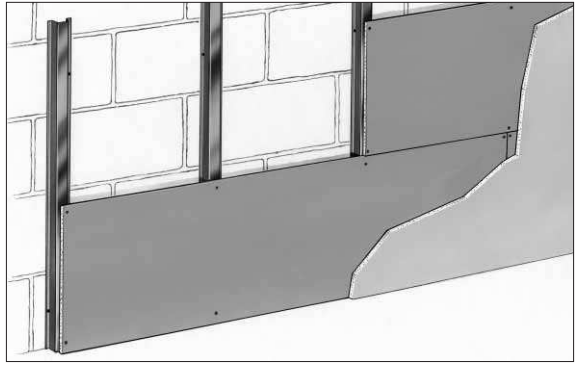
Metal furring

significant slab live load deflection must be accommodated, the anchoring of these studs may restrict slab movement and cause partition cracking. In these cases, anchoring of these studs may need to be omitted. The services of a design professional is desirable to identify these instances and address them on a case-specific basis. Attach GRAND PRIX Plaster Base to studs. Apply 12.7 mm (1/2") sanded basecoat plaster, lime putty finish.

Metal Channel— For direct attachment with metal furring channels, GRAND PRIX Plaster Base is screwed to furring channels that are attached directly to an exterior masonry wall. When a 6-mil polyethylene film is included, the system provides an excellent vapor retarder.

Installation Apply channels vertically to masonry not more than 400 mm (16") o.c. Fasten each channel with hammered or power-driven stud fasteners. If there is a possibility of water penetration, install an asphalt felt protection strip between the furring channel and wall surfaces.

Frame Spacing and Attachment

For Furred Ceilings Fasten 19 mm (3/4") cold-rolled channel or 10 mm (3/8") pencil rods directly to bottoms of framing members. On concrete joists, 4 mm (8-ga.) galvanized wire can be put in place before the concrete is poured. Space furring members as shown in the following cross-furring member spacing table. For joists spaced about 635 mm (25") o.c., attachment of 19 mm (3/4") channels may be on alternate joists; if greater than 635 mm (25") o.c. but not more than 1220 mm (48") o.c., place attachment at every joist.

On steel joists or beams, place 19 mm (3/4") cold-rolled channels at right angles to joists; attach with 3 strands 1.2 mm (18-ga.) galvanized wire.

For Suspended Ceilings Space 4 mm (8-ga.) wire hangers not over 1220 mm (4') o.c. in direction of 38 mm (1-1/2") carrying channels and not over 915 mm (3') o.c. at right angles to direction of carrying channels. If hanger wires are 915 mm (3') o.c. in direction of 38 mm (1-1/2") channels, then channels at right angles may be 1220 mm (4') o.c. Place hangers within 150 mm (6") of ends of carrying channel runs and of boundary walls, girders or similar interruptions of ceiling continuity. Position and level carrying channel and saddle tie securely with hanger wire.

Position 19 mm (3/4") cold-rolled channel (cross-furring) across carrying channels, spacing them 300 to 600 mm (12" to 24") depending on type of metal lath to be used, and saddle tie carrying channels with three strands of 18-ga. tie wire.

Apply 1.8 kg/m² (3.4-lb.) DIAMOND Mesh Lath, Flat Riblath or 9.5 mm (3/8") Riblath as specified with long dimension of sheets across the supports. Details on lathing procedures and control joints follow later in this chapter.

Frame and Fastener Spacing—GRAND PRIX Plaster Base

Type Framing	Base Thickness		Fastener ⁽¹⁾	Max. Frame Spacing		Max. Fastener Spacing	
	mm	in.		mm	in.	mm	in.
Wood stud	9.5	3/8	Nails 13 ga., 29 mm long, 7.5 mm flat head, blued Staples—16-ga. galv. flattened wire, flat crown 11 mm wide, 25 mm divergent legs	400	16	125	5
Steel stud	9.5	3/8"	25 mm Type S Screws	400	16	300	12
Metal furring	9.5	3/8"	25 mm Type S Screws	400	16	300	12

(1) Metric fastener dimensions: 7.5mm=19/64"; 11mm=7/16"; 25mm=1"; 29mm=1-1/8".

Maximum Frame Spacing—Metal Lath⁽¹⁾

Product	Weight		Spacing	
	kg/m ²	lbs./yd. ²	mm	in.
DIAMOND Mesh ⁽²⁾	1.4	2.5	300 ⁽³⁾	12 ⁽³⁾
	1.8	3.4	400	16
9.5 mm (3/8") Riblath	1.8	3.4	600	24
Flat Riblath	1.5	2.75	400	16 ⁽⁴⁾
	1.8	3.4	480	19 ⁽⁵⁾

(1) For spacing on fire-rated constructions, see test reports. (2) 1.4 kg/m² (2.5-lb.) lath should not be used for ceilings. (3) 400 mm (16") o.c. permitted with wood framing and 51 mm (2") solid partition. (4) Spacing of metal ceiling grills 300 mm (12") o.c. (5) 600 mm (24") spacing with solid partition.

Support Area—Hangers

Hanger Size and Type	Max. Ceiling Area per Hanger		Allowable Tensile Load	
	m	ft. ²	kg	lbs. ⁽⁹⁾
3.8 mm (9-ga.) galvanized wire	1.2	12.5	154	340
4 mm (8-ga.) galvanized wire	1.5	16	185	408
4.8 mm (3/16") mild steel rod ⁽¹⁾⁽²⁾	1.9	20	247	546
6.4 mm (1/4") mild steel rod ⁽¹⁾⁽²⁾	2.1	22.5	440	972
4.8mm x 25.4mm (3/16" x 1") mild steel flat ⁽¹⁾⁽²⁾	2.3	25	1683	3712

(1) Where severe moisture conditions may occur, rods galvanized or painted with rust-inhibitive paint, or galvanized straps are recommended. (2) Not manufactured by CGC. (3) Based on minimum yield 228 mPa (33,000 psi).

Maximum Spacing—Main Runner—Carrying Channels

Main Runner C. R. Channel Size		Max c. to c. Spacing of Main Runners		Max. Spacing of Hangers Along Runners	
mm	in.	mm	ft.	mm	ft.
19	3/4	900	3	600	2
19	3/4	680	2-1/4	900	3 ⁽¹⁾
38	1-1/2	1220	4	900	3
38	1-1/2	1060	3-1/2	1060	3-1/2
38	1-1/2	900	3	1220	4
51	2	1220	4	1520	5
51	2	760	2-1/2	1830	6
51	2	600	2	2130	7

(1) For concrete joist construction only—where 4 mm (8-ga.) wire may be inserted in joist before concrete is poured.

Maximum Spacing—Cross-Furring Members

Cross-Furring Size	Max. c. to c. Spacing of Cross-Furring		Main Runner or Support Spacing	
	mm	in.	mm	ft.
19 mm (3/4") C. R. Channel	600	24	900	3
19 mm (3/4") C. R. Channel	480	19	1060	3-1/2
19 mm (3/4") C. R. Channel	400	16	1220	4

Plaster Base Application

Plaster bases may be classified as gypsum base, metal lath base or masonry base. These materials provide a surface for plastering and add reinforcement to the plaster. As such, they must be rigid enough to accept plaster and produce a secure bond between plaster and base—both necessary to develop strength and resistance to abuse and cracking.

To ensure adequate rigidity of plaster constructions, recommendations for the spacing of supports and fasteners must be strictly followed.

Apply plaster bases to ceilings first and then to partitions, starting at the top and working down to the floor line.

GRAND PRIX Plaster Base An ideal high-suction rigid base for gypsum plasters, should be applied face out with long dimension across supports and with end joints staggered between courses. Cut lath accurately so it slips easily into place without forcing and fits neatly around electrical outlets, openings, etc. Install any lengthwise raw cut edges at bottom strip or wall-ceiling angle. Apply Cornerite to all interior angles and staple to the lath only.

Metal Lath Should be applied with long dimension across supports and with end joints staggered between courses. Apply Riblath with the rib against supports. Lap ends of metal lath 25 mm (1") and sides at least 13 mm (1/2"). Lap Riblath by nesting outside ribs. If end laps occur between supports, they should be laced or tied with 1.2 mm (18-ga.) tie wire. Secure lath to all supports at intervals not exceeding 150 mm (6"). At all interior angles, metal lath should be formed into corners and carried out onto abutting surface.

Clay Tile and Brick Frequently used for plaster bases. Care should be taken to make sure that surfaces are sufficiently porous to provide suction for the plaster and are scored for added mechanical bonding. Smooth-surfaced clay tile that is glazed or semi-glazed does not offer sufficient bond for plaster.

Concrete Block A satisfactory base for plaster. The surface should be porous, for proper suction, or face-scored for adequate mechanical bond. Units must be properly cured to minimize dimensional changes during and subsequent to plastering.

Monolithic Concrete Ceilings, walls, beams and columns should have a complete and uniform application of USG Plaster Bonder before plastering. This surface treatment produces an adhesive bond suitable for direct application of gypsum plasters.

Plastering Direct to Interior Face of Exterior Masonry Walls Not recommended. Exterior walls are subject to water seepage and moisture condensation that may wet the plaster and damage interior decoration.

Bituminous Waterproofing Compounds Do not provide a good plaster base. Gypsum plasters should not be applied to surfaces treated with these compounds.

Rigid Foam Insulations Such insulations have not proven to be satisfactory bases for direct application of gypsum plaster because of rigid foam insulation's low suction characteristics and low structural strength which may result in cracking of the plaster.

CGC does not recommend direct application of plaster to rigid foam insulation. However, some rigid foam insulation manufacturers have specific directions for application when direct plastering is to be used, as well as detailed specifications for plaster mixes and methods of application to be employed. Confirm local fire code compliance prior to installation.

CGC has designed various furring systems (covered earlier in this chapter) that avoid the need to apply plaster to these unsuitable surfaces and do provide high-quality plaster finishes over the inside of exterior walls.

Fastener Application

Correct fastener selection and adherence to fastener spacing are extremely important to good plastering performance and absolutely essential in meeting the requirements of specific fire-rated constructions.

Gypsum Plaster Bases Attached to framing with screws or nails or staples. Nails and screws and staples should be driven so that the fastener head or crown bears tightly against the base but does not cut the face paper. To prevent core fracturing, they should be driven at least 9.5 mm (3/8") away from ends and edges. Staples should be of flattened wire driven so the crown is parallel to wood framing. Screws should be used to attach gypsum plaster bases to steel studs, furring channels or RC-1 Resilient Channels.

For screw attachment of single-layer 9.5 mm (3/8") GRAND PRIX Plaster Base to steel studs or furring channel, 25 mm (1") TYPE S Bugle Head Screws are used.

Nail Application Begin from center of base and proceed toward outer ends or edges. When nailing, apply pressure adjacent to nail being driven to insure base is secured tightly on framing member. Position nails on adjacent ends or edges opposite each other and at least 10 mm (3/8") from ends and edges. Drive nails with shank perpendicular to plaster base. The nail heads should be driven flush with paper surface but not break paper.

Metal Lath Attach to cold-rolled channel framing with tie wire (min. 1.2 mm (18 ga.)) and to wood framing with fasteners engaging two strands or a rib and providing at least 19 mm (3/4") penetration.

**Gypsum
Lath—Steel
Studs**

Screw Attachment Fasten to studs spaced 400 mm (16") o.c. with three 25 mm (1") TYPE S Screws per stud spaced 50 mm (2") from edge of lath. TYPE S-12 Screws are required for heavier gauges. Drive screws with an electric screwgun.

**Gypsum
Lath—Wood
Framing (direct)**

Nail GRAND PRIX Plaster Base with face out and long dimension across or parallel to framing members. Stagger end joints in successive courses. Butt all joints together and cut lath to fit neatly around electrical outlets and other openings.

Place fasteners at least 10 mm (3/8") from edges and ends of lath. Make all interior plaster angles the floating type and space first fasteners at least 250 mm (10") from corner. Reinforce angle with Cornerite stapled to lath surface.

**Metal
Lath—Wood
Framing (direct)**

Apply metal lath with long dimension of sheet across supports. Lap ends of lath at least 25 mm (1") and if laps occur between supports, lace or tie with 1.2 mm (18-ga.) tie wire. Attach with fasteners 150 mm (6") o.c. so fastener engages two strands or a rib and provides at least 19 mm (3/4") penetration.

On walls, place metal lath so that the lower sheets overlap upper sheets and, where possible, stagger ends of lath in adjacent courses.

At all interior angles, form lath into corners and carry out onto abutting surface. Secure lath to joists with 25 mm (1") galvanized nails, to studs with nails or staples providing min. 19 mm (3/4") penetration.

Control Joint Application

8

Lath and plaster surfaces will not resist stresses imposed by structural movement. Additionally, plaster assemblies are subject to dimensional changes caused by fluctuations in temperature and humidity. (See thermal and hygrometric coefficients of expansion in Appendix.) Such surfaces should be isolated from the following structural elements by zinc control joints, casing beads or other means where:

- a. A partition or ceiling abuts any structural element other than the floor, a dissimilar wall or partition assembly, or other vertical penetration.
- b. The construction changes within the plane of a partition, or ceiling and wings of "L-," "U-" and "T-" shaped ceilings are joined.

In long partition runs, control joints should be provided at max. 9 m (30') o.c. Door frames extending from floor to ceiling may serve as control joints. For less-than-ceiling-height doors, control joints extending from center or both corners of frame to ceiling is an effective application. If control joints are not used, additional reinforcement is required at corners to distribute concentrated stresses. (Door frame details appear later in this chapter.) In exterior wall furring systems, control joints must be provided at the same locations where control joints in the exterior walls are located and at max. 9 m (30') o.c.

Control joints will not accommodate transverse shear displacement on opposing sides of a joint. A joint detail comprising casing beads each side of the joint opening is typically used to accommodate expansion,

contraction and shear. Such joints require special detailing by the designer to control sound and fire ratings, where applicable, as well as dust and air movement. In exterior walls, particular attention is required to resist wind, driving rain, etc., by adequate flashing, backer rod, sealants and gaskets as required.

Large interior ceiling areas with perimeter relief should have control joints spaced at max. 15 m (50') o.c. in either direction; without perimeter relief, 9 m (30') o.c. maximum in either direction. The continuity of both lath and plaster must be broken at the control joints. Control joints should be positioned to intersect light fixtures, heating vents, or diffusers, etc., which already break ceiling continuity, and are points of stress concentration.

Maximum Spacing—SHEETROCK Brand Control Joints for Interior Plaster Assemblies

System	Location	Max. Single Dimension	
		m	ft.
Metal Lath & Plaster	Partition	9	30
	Ceiling	15	50 ⁽¹⁾
		9	30 ⁽²⁾
Gypsum Lath & Plaster	Partition	9	30
	Ceiling	15	50 ⁽¹⁾
		9	30 ⁽²⁾

(1) With perimeter relief (2) Without perimeter relief

Control Joint Nos.
50, 75, 100

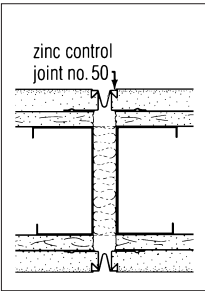
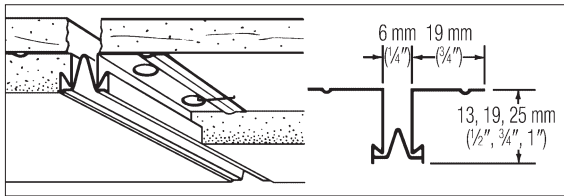

Wall control joint installation

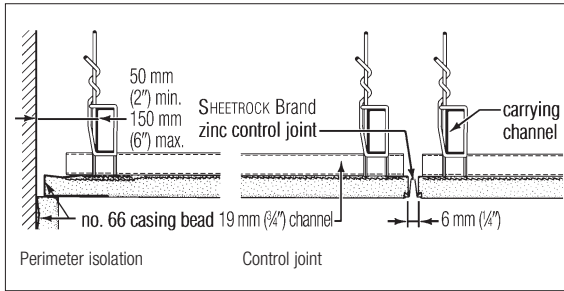

Ceiling control joint installation

Installation Provide a break in the lath at location of control joint. At this location install double framing members, one on each side of the break and 13 to 19 mm (1/2" to 3/4") apart. Place control joints over all control or relief joints within structural frame of building. Staple or wire tie perforated flanges of control joint to lath. Plaster flush to grounds. Remove factory-applied protective tape after completion of finished surface.

Zinc control joints must be properly insulated or otherwise protected when used in fire-rated assemblies.

Basecoat Plaster Application

For the beauty and durability of which plaster is capable, certain requirements should be followed regarding the number of coats applied. Three-coat work is necessary on all metal lath and on edge-supported gypsum lath used in ceilings; three-coat work is desirable on all gypsum lath but two-coat work is acceptable when gypsum lath is properly supported and on masonry plaster bases (rough concrete block, clay tile, porous brick).

In preparing for plastering, consideration should be given to the selection of materials not only for compatibility but for the quality of the structure to be plastered. It is wise to upgrade plastering specifications when possible.

The “Plaster Product Compatibility Selector” table below will help you determine which basecoat plaster is appropriate for each possible substrate and which finish plasters may be used with each basecoat plaster. The table on “Basecoat Plasters for Conventional Plaster Systems” provides a numeric scale comparing the performance of various basecoat plasters over various substrates and for various properties. The table on “Basecoat Plaster (Over Metal Lath)” provides mixing proportions of sand to plaster.

Plaster Product Compatibility Selector

Basecoat Plaster	Substrate					Finish Plaster							
	CMU	Mono. Conc. ⁽¹⁾	ML CH-FMG	ML C-Studs	GRAND PRIX Plaster Base	RED TOP Finish	STRUCTO-GAUGE/ Lime	Keenes/ Lime	Gauging/ Lime	Keenes/ Lime/ Sand	Gauging/ Lime/ Sand	IMPERIAL Brand Finish	DIAMOND Brand Interior Finish
Two Purpose ⁽²⁾	✓	✓	✓		✓	✓	✓	✓	✓	✓			✓
STRUCTO-LITE Gypsum Plaster	✓	✓	✓		✓				✓ ⁽³⁾	✓	✓		

Notes: (1) CGC Plaster Bonder must first be applied. (2) Job sanded. (3) Not over metal lath. Monolithic concrete to be treated with CGC Plaster Bonder. ✓ = Acceptable
Special Purpose Plasters available on special order (Wood Fiber, STRUCTO-BASE, Keenes Cement).



Basecoat Plasters for Conventional Plaster Systems

Product	Substrate				
	Metal Lath	Concrete Masonry Unit	Gypsum Lath	Hardness	Productivity
STRUCTO-LITE Gypsum Plaster	4	1	2	4	1
RED TOP Gypsum Plaster	3	3	2	3	3

1 = Excellent 2 = Very Good 3 = Good 4 = Acceptable

Basecoat Plaster (Over Metal Lath)

Scratch Coat	Brown Coat
Two Purpose Plaster, sanded 100 lbs. : 2 cu. ft.	Two Purpose Plaster, sanded 100 lbs. : 3 cu. ft.
45 kg (100 lbs.) of Plaster : 0.05 m ³ (2 cu. ft.) of sand	45 kg (100 lbs.) of Plaster : 0.08 m ³ (3 cu. ft.) of sand

The architect’s specifications and the plaster base used will determine the plastering method, either two-coat or three-coat.

Two- and Three-Coat Plastering

Two-Coat Plastering with Conventional Plasters Generally accepted for plaster application over gypsum lath and masonry. The base (first) coat should be applied with sufficient material and pressure to form a good bond to the base and to cover well; then be doubled back to bring plaster out to grounds, straightened to true surface with rod and darby without use of additional water, and left rough and open to receive the finish (second) coat.

Three-Coat Plastering Required over metal lath and edge-supported gypsum lath used in ceilings. It is preferred for other bases because it develops a harder, stronger basecoat. The scratch (first) coat should be applied with sufficient material and pressure to form good full keys on metal lath, and a good bond on other bases, and then cross-raked. The brown (second) coat should be applied after scratch (first) coat has set firm and hard, brought out to grounds and straightened to true surface with rod and darby without use of additional water, and left rough and open to receive the finish (third) coat.

To obtain the full hardness, high strength and superior performance available in gypsum basecoat plasters, water, aggregates and setting time must be carefully controlled. In addition, proper mixing and drying of the plaster are required to obtain these superior functional characteristics.

Grounds

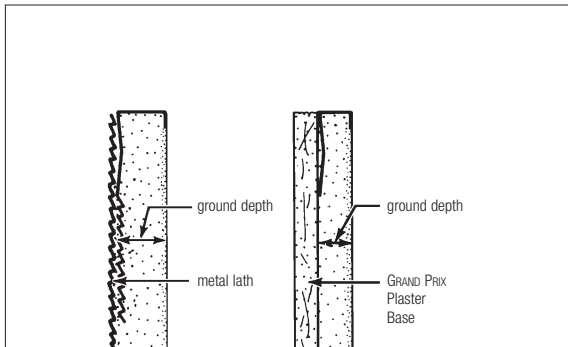

Grounds

The thickness of conventional basecoat plaster is one of the most important elements of a good plaster job. To ensure proper thickness, grounds should be properly set and followed.

Grounds may be defined as wooden strips, corner beads (plumbed and aligned) or metal casing beads applied at the perimeter of all openings and other locations.

In addition to these, and especially on walls with no openings and on ceilings, plaster screeds should be installed to ensure plumb and level surfaces. Plaster screeds are continuous strips of plaster, approximately 100 mm (4") wide, applied either vertically or horizontally and plumb with the finish wall line, allowing for 1.6 mm (1/16") finish coat.

Grounds should be set to obtain the following minimum plaster thicknesses:

1. Over gypsum lath	13 mm (1/2")
2. Over brick, clay tile, or other masonry	16 mm (5/8")
3. Over metal lath, measured from face of lath	16 mm (5/8")

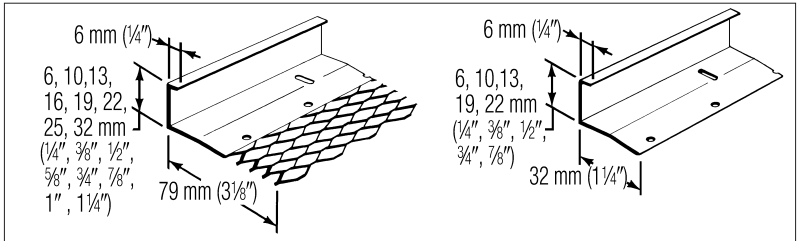

#66 Square Edge Casing Beads
(expanded or short flange)

Mixing

Use of the proper type of mechanical mixer assures that the plaster aggregate and water are evenly mixed. Keep the mixer continually clean—a most important precaution because partially set material is a powerful accelerator.

Proportioning is *Weight of Gypsum to Volume of Aggregate* A 100:1 mix would use one cubic foot of sand or 0.028 m³ (28 L) to 100 lb. or 45 kg of gypsum plaster, a 100:2 mix 2 cubic feet or 0.057 m³ (57 L), and a 100:3 mix 3 cubic feet or 0.085 m³ (85 L).

Perlite is generally packaged in bags containing 0.085 or 1.1 m³ (3 or 4 cu. ft.) for easy proportioning.

Prepare only one hour's supply of plaster at one time and do not remix if plaster has started to set. All such plaster should be discarded.

Water All gypsum plasters require addition of water on job. Water should be clean, fresh, suitable for domestic consumption, and free from mineral and organic substances which affect plaster set. Water used earlier for rinsing or cleaning containers and tools should not be used, as it accelerates plaster set.

Only enough water should be used to provide a plaster of workable consistency. Too much water in machine-applied plasters (in excess of 10% more than for hand-applied mixes) or over-aggregated plasters will cause weak, soft walls and ceilings. Excessive water reduces plaster strength and hardness.

Aggregates

Added to conventional gypsum plasters to extend coverage, reduce shrinkage, and lower cost. Aggregates recommended are: (1) sand, which is denser, stronger and dampens sound transmission better than lightweight aggregates, and (2) perlite, a lightweight aggregate that generally offers better fire resistance, insulation values and reduced weight. For sand-float finishes the aggregate should be a fine silica sand.

All aggregates used should have proper gradation of size as outlined in ASTM C35. Improperly sized aggregates will produce weak walls. Sand should be clean and free of dirt, clay and foreign matter that might affect the setting time of plaster. Perlite-aggregated plasters should not be machine-applied when vertical lift is over 9 m (30 ft.) or hose length exceeds 46 m (150 ft.) Maximum recommended proportions for aggregates are shown in following table.

Maximum Aggregate Quantity—Gypsum Plasters

Base	No. Coats ⁽¹⁾	Coat	Under Smooth Trowel Finishes				Under Texture Finishes			
			Sand ⁽²⁾		Perlite ⁽³⁾		Sand ⁽²⁾		Perlite ⁽³⁾	
			m ² /t	ft. ³ /100 lb.	m ² /t	ft. ³ /100 lb.	m ² /t	ft. ³ /100 lb.	m ² /t	ft. ³ /100 lb.
Gypsum Lath	3	Scratch	1.24	2	1.24	2	1.24	2	1.24	2
		Brown	1.86	3	1.24	2	1.86	3	1.86 ⁽⁴⁾	3 ⁽⁴⁾
	2	Basecoat ⁽⁵⁾	1.55	2.5	1.24	2	1.55	2.5	1.24	2
Metal Lath	3	Scratch	1.24	2	—	—	1.24	2	1.24	2
		Brown	1.86	3	—	—	1.86	3	1.24	2
Unit Masonry	3	Scratch	1.86	3	1.86	3	1.86	3	1.86	3
		Brown	1.86	3	1.86	3	1.86	3	1.86	3
	2	Basecoat ⁽⁵⁾	1.86	3	1.86	3	1.86	3	1.86	3

(1) Includes finish coat. (2) Approx. 6 No. 2 shovels of sand equal 0.028 m³ (1 cu. ft.). (3) In a construction with metal lath as the plaster base, perlite aggregate is not recommended for use in the basecoat plaster, except under a float finish. For a smooth trowel finish over a perlite aggregated basecoat on any plaster base except metal lath, add 0.014 m³ (14 L) (1/2 ft.³) of fine silica sand per 45 kg (100 lb.) of gauging plaster, or use aggregated gauging. (4) Only if applied 25 mm (1") thick, otherwise 1.24 m²/t (2 ft.²). (5) Basecoat applied scratch and double-back.

Setting Time

The proper setting time for conventional basecoat plasters is generally from 2 to 4 hours after mixing, and this should be checked for close conformity on both the scratch coat and brown coat operations. Normally, plaster shipped to the job will fall in this range. If conditions exist that affect normal setting time, retarders or accelerators may be used.

Retarders The danger of "quick set" plaster is insufficient time to get the plaster from mixer to walls without retempering on mortar board, and such retempering will produce a plaster of lower than normal strength. The correction for "quick set" is to add the minimum required amount of retarder in solution with water in the mixer.

Good job practice for retarder use involves mixing a trial batch of formulated product and determining the set time. Once the set time is known, a measured amount of USG retarder and water mixture is added to adjust the set. Any available container (wax cup, coffee can, measuring cup, etc.) can be used to measure the retarder/water mixture. Keeping mixing equipment clean between batches helps prevent quick-setting action in subsequent mixes.

Retarder selection will depend on the length of time extension required to handle the job appropriately, and the type of plaster being used. USG Standard Strength Retarder is recommended for slight to moderate lengthening of set times and can be used with conventional and veneer

plasters. Mix 5 mL (one teaspoon) of dry USG Standard Strength Retarder with 150 mL (5 oz.) water to extend the set time of a 45 kg (100-lb.) batch of gypsum plaster by 30-40 minutes or more.

USG High Strength Retarder is used to extend setting times 2 hours or more and is especially suitable for conventional gypsum plasters where machine application set time alteration is required. Mix 5 mL (one teaspoon) of dry USG High Strength Retarder with 150 mL (5 oz.) water to extend the set time of a 45 kg (100-lb.) batch of conventional gypsum plaster by 1-3 hours.

For larger quantities, premix 500 g (1 lb.) of retarder to 8 L of water. Stir to make sure retarder is completely dispersed. Screen out any lumps that may have formed, as they will cause soft discolored spots in the plaster surface. Note that retarder is dispersed in the water, not dissolved. Stir thoroughly before each use.

USG Retarder for Lime Containing Plaster Products is used with such plasters as DIAMOND Brand Interior Finish, and gauging/lime finishes. This retarder may be added directly to the mixing water prior to addition of plaster. As little as 1 to 2 mL (1/4 to 1/2 teaspoon) per 23 kg (50-lb.) bag of lime-containing plaster will extend setting time by 20 minutes.

Accelerators If plaster does not set for 5 to 6 hr., no harm will be done to the resulting plaster surfaces, but a “slow set” of the plaster (generally one taking more than 6 hr.) should be avoided by adding accelerator at the mixer, as such plaster may be subject to a “dryout,” particularly in hot, dry weather, and will have a lower than normal strength when finally set. A choice of accelerators is available depending on the degree of acceleration required and the type of plaster being used.

USG Standard Strength Gypsum Plaster Accelerator is used to slightly modify setting times of veneer and conventional plasters. To maximize the ability of the accelerator, sprinkle 120 g (4 oz.) of USG Standard Strength Gypsum Plaster accelerator in dry form into the mixer for each bag of product after the plaster has been added. This amount of accelerator will reduce set time by 30 minutes.

USG High Strength Gypsum Accelerator is used to reduce setting time of conventional basecoat plaster by 1-1/2 to 2 hours. For best results, sprinkle 60 g (2 oz.) of USG High Strength Gypsum Accelerator in dry form into the mixer for each bag of product after the plaster has been added.

USG Accelerator—Alum Catalyst is used to correct “dryout” conditions. Accelerating the set of the plaster surface eliminates dry-out shrinkage fissures that occur when the material dries faster than the normal setting time. The same result can be accomplished by fog-spraying the plaster with water from a garden hose to saturate the plaster and then floating the surface with a wooden float to fill in any already formed fissures, however the alum catalyst accelerator can help avert the problem. Mix 250 to 500 g (1/2 to 1 lb.) of USG Accelerator—Alum Catalyst into 12 L of water in a garden sprayer. Spray solution onto the damp plaster surface. Applying the solution in combination with rewetting quickens the set time to prevent a recurrence of the dry-out condition.

Heating and Ventilation

Plaster must not be applied to surfaces that contain frost. A min. temperature of 13°C (55° F) should be maintained for adequate period prior to, during, and after application of plaster. In cold, damp or rainy weather, properly regulated heat should be provided but precautions must be taken against rapid drying before set has occurred. This prevents 'dryouts.'

As soon as set occurs in conventional plasters, free circulation of air should be provided to carry off excess moisture. Heating should be continued to ensure as rapid drying as possible. In hot, dry weather, protect plaster from wind and from drying unevenly or too rapidly before set has taken place. If windows or curtain walls are not in place, exterior openings in the building should be screened.

Finish Plaster Application

Finish plasters applied to basecoats provide the surface for final wall or ceiling decoration. Finish coats should be applied only to properly prepared basecoats which are rough and open and partially dry.

Trowel Finishes Used where a smooth, easily maintained surface is desired, often as a base for paint or wall coverings. The degree of hardness, porosity, and polish is determined by the materials and application techniques used. When a smooth-trowel gauged lime putty finish is used over a basecoat containing lightweight aggregate on any plaster base except metal lath, three options are available. Either add at least 23 kg (50 lb.) of fine silica sand or 14 L (0.014 m³) (1/2 cu. ft.) of perlite fines per 45 kg (100 lb.) of gauging plaster or use a mill-aggregated gauging plaster.



Trowel finish

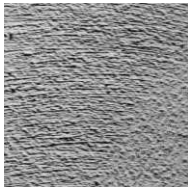

Float finish

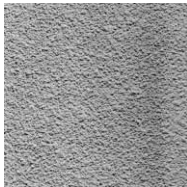

Spray finish

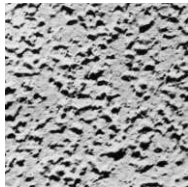

Texture finish

Finish Plasters for Conventional Plaster Systems

		Easy to Achieve		Texture Capability		
		Smooth Surface	Surface Hardness	Productivity	Unsanded	Sanded
Veneer plaster finishes over conventional basecoat	IMPERIAL Brand Finish Plaster*	4	1	4	3	2
	DIAMOND Interior Finish Plaster*	3	3	2	3	2
Lime-gauging finishes over veneer basecoat or conventional basecoat	SNOWDRIFT/RED TOP Lime and Gauging Plaster	1	4	3	4	2

*Not recommended for use over lightweight aggregate basecoats.
 1 = Excellent 2 = Very Good 3 = Good 4 = Acceptable N/A = Not Applicable

Application To avoid blistering, allow basecoat to dry sufficiently or use a quick-set gauging plaster. Use 23 kg (50-lb.) bag of SNOWDRIFT Lime with 21 to 23 L water. Machine-mix for immediate use.

Scratch in thoroughly, then immediately double-back to a thickness of not more than 1.6 mm (1/16") and trowel to a smooth, dense surface ready for decoration.

Float Texture Finishes Provide attractive, durable finishes where surface textures are desired. They are recommended for use over all types of gypsum basecoats and are the most desirable finishes from the standpoint of crack resistance. The surface texture is easily controlled and can be produced by a variety of hand tools.

Application, Sand Float Finish Scratch plaster in thoroughly and immediately double back to a true, even surface. Float using a (shingle) (cork) (wood) (carpet) (sponge), or (rubber) float to bring aggregate to the surface to produce a finish of uniform texture free of slick spots, cat faces, and other blemishes. Use water sparingly on natural colour, and no water on coloured finishes.

Application, Machine Spray Texture Finish Acceptable finishes can be achieved using either a hand-held hopper gun or other machines specifically designed for spray-applying plaster.

The aggregate size, number of passes over the surface, air pressure and nozzle orifice can be varied to achieve the desired texture. When spraying, it is best to spray first in one direction and then in another direction crossing the first direction at right angles.

Before beginning spray application, test the pattern and make the necessary adjustments to give the desired appearance. There are many things that affect the pattern including the following:

1. **Orifice Size** The smaller the orifice or nozzle tip, the finer the spray.
2. **Air Pressure** If no other changes are made, the higher the air pressure, the finer the spray.
3. **Liquid State** The liquid state of the material should be like medium thick cream. The condition is obtained by taking the regular mix and adding more water until it comes to the desired consistency. It is good practice to pass the mix through a screen that will trap all particles larger than the aggregate being sprayed.

Basecoat must be free of ridges or other surface imperfections. Spraying texture finish directly onto basecoat is not normally recommended. The preferred method is to hand-apply a scratch coat before spray-applying finish. Finish materials for this method include gauging plaster, mixed with lime and silica sand; or various single component prepared finishes designated for two-component systems.

With finish coat material mixed for hand application, apply a well ground-in scratch coat over properly set and partially dry brown coat. After scratch coat is applied, double back with sufficient material to cover the basecoat completely. When the surface has become firm by water removal, float it to a uniform, blemish-free flat texture. After scratch and double-back set, and while material is in a wet state, spray

material should be prepared using the same proportions as the finish material and mixed to proper fluidity for achieving the final texture finish. Spray texture to a uniform thickness and appearance.

Other Texture Finishes Many pleasing and distinctive textures are possible using various techniques in finishing. Finishes may range from an extremely fine stipple to a rough, heavy or coarse texture. Variety is limited only by the imagination of the designer or the ingenuity of the applicator.

Finish Plaster Limitations Certain precautions must be observed when applying finish coat plasters over various basecoats:

1. A smooth-trowel finish should not be used over lightweight aggregate gypsum basecoat applied over metal lath. A sand-float finish is recommended.
2. Do not use STRUCTO-LITE over metal lath. For a smooth-trowel finish coat over lightweight STRUCTO-LITE base coat, the addition of an aggregate to the finish coat is required. The finish coat should be gauging plaster and lime with the addition of 23 kg (50 lb) of No 1 white silica sand or 0.014 m³ (14 L) (1/2 ft.³) of perlite fines.
3. Gypsum or lime-base finishes, including Keenes Cement, should not be used directly over a portland cement basecoat or over concrete block or other masonry surfaces.
4. In smooth trowel finishes, gauging plasters providing an extremely hard surface, such as STRUCTO-GAUGE and Keenes Cement, must not be used over STRUCTO-LITE Plaster or a basecoat with a lightweight aggregate.
5. Lime putty cannot be used without the addition of gauging plasters. When used alone as a finish plaster, lime does not set, is subject to shrinkage when drying and lacks hard finish.

Gauging Plasters

Gauging Plasters Gauging plaster (see following pages for full description) is blended into the lime putty in the proper proportions to provide controlled set, early hardness and strength, and to prevent shrinkage cracks.

Mixing Add gauging plaster to lime putty in proportion of 1 part dry gauging plaster by weight to 2 parts dry lime by weight or 1 part dry gauging by volume to 3 parts lime putty by volume. To mix, form a ring of lime putty on mixing board. The volume of putty used depends on wall or ceiling area to be covered. A hod of lime putty weighs approx. 45 kg (100 lb.), a (14 L) bucket of lime putty about 16 kg (35 lb.) 23 kg (50 lb.) dry lime equals 45 kg (100 lb.) lime putty). After forming the putty ring, pour clean water into center of ring in correct proportions: (7 L) water to 45 kg (100 lb.) lime putty; (2 L) water to each (14 L) bucket of lime putty. Next, sift Slow or Quick Set gauging plaster into water; 11 kg (25 lb.) gauging plaster to one hod of lime putty. Thoroughly wet gauging plaster and blend materials thoroughly to prevent gauging "streaks" and provide uniform density.

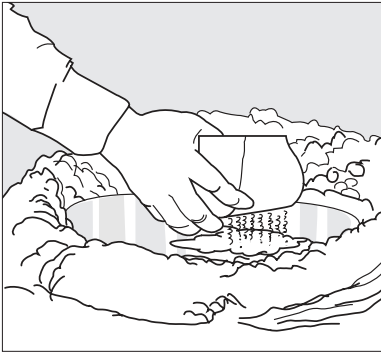

Sift gauging plaster into water

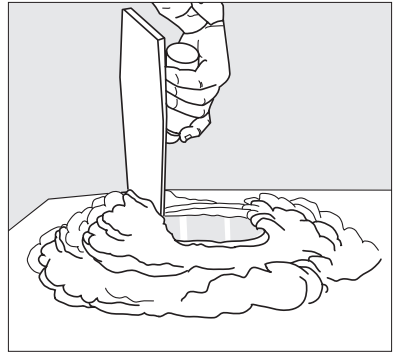

Mix to blend thoroughly

To protect against finish coat check or map-cracking, add 14 L (0.014 m³) (1/2 ft.³) perlite fines or 23 kg (50 lb.) fine silica sand to every 45 kg (100 lb.) of gauging used. This addition is necessary when applying smooth troweled finishes over lightweight aggregate basecoats. Mill-aggregated gauging plasters are available and eliminate the need for on-the-job measuring.

Application Apply the gauged lime putty over a partially dry basecoat. Scratch in a thin coat, well ground into the basecoat, and double-back with a second coat, filling imperfections. After basecoat has absorbed most of excess water from finish, trowel to densify surface. As final set takes place, water-trowel surface to provide a dense, smooth surface.

Generally, gauging plaster set times with lime putty are 50-75 min. for slow set and 30-40 min. for quick set formulas.

Finish Limes

The two types of finish lime are: (1) Type S (also called autoclaved, pressure or double hydrate); (2) Type N (also called normal or single hydrate). Both produce a good finish lime putty, but their preparation differs. Weather precautions:

In Cold Weather A few precautions will result in improved quality and easier working. Where weather and water are cold, lime develops better plasticity when soaked overnight. Best conditions are a warm room and water temperature above 10°C (50° F).

It is important to note that in cold weather the lime putty-gauging mixture requires a longer time to set. Therefore, gauging content should be increased or quick-set gauging added to offset the slower setting time.

Proper heat and ventilation are extremely important. Windows should be opened slightly so that moisture-bearing air moves out of the building. Fast drying after setting is essential to a hard finish.

Many cold-weather problems with finish lime are a direct result of improper basecoat conditions. Finish should go over a set, fairly dry basecoat. The basecoat will dry slowly in winter, so heat and ventilation are needed. The water retentivity of lime putty, plus a cold, "green" base, does not provide enough suction to remove excess moisture. Blistering and cracking can occur due to slow set.

In Hot Weather Precautions include proper soaking of lime putty. When the sun is hot, hydrated lime requires 1.9 to 3.78 L (1/2 to 1 gal.) more water per 23 kg (50 lb.) The water should be cool. Soaking of putty in shade prevents undue water evaporation and helps to prevent curdling and loss of spreading properties. Avoid soaking for periods longer than two or three days.

For application of lime putty-gauging finish plaster, make sure that basecoat is set and partially dry. If applied over a dried-out basecoat, water will be drawn from the finish coat, resulting in severe check-cracking. Spray the basecoat before finish coat application and trowel coat until final set.

SNOWDRIFT Finish Lime Autoclaved (double-hydrate)

Mixing Machine equipment must be clean. Place 21 to 23 L clear water per 23 kg (50-lb.) bag of lime in mixer. Using a motor-driven, propeller-type mixer, the complete mixing of lime putty takes 2 to 3 min. and results in a high-quality, easy-working putty. Machine-mixed putty is plastic and coverage is increased from 10% to 15%. With a paddle-type mixer, the mixing time is about 15 min. **Hand Mixing**—For immediate use, place 21 to 23 L water per 23 kg (50 lb.) SNOWDRIFT Finish Lime in mixing box. Add finish lime to water and hoe sufficiently to eliminate lumps. Screen putty through 8-mesh (2.5 mm (0.1") opening) screen before using. **Overnight Soak**—Place water hose in bottom of a level soaking box. Sift lime through screen into box. When full, run water slowly, but continuously, until a small amount of excess water is visible over top of lime. If excess water remains on the surface the following morning, absorb excess water by screening in additional SNOWDRIFT Lime, allow to soak a few minutes, then blend into putty by hoeing. For use, if necessary, screen through 8-mesh hardware cloth and mix with gauging plaster that meets job requirement. **Application**—follow directions for Gauging Plasters.

RED TOP Lime Single or Normal Hydrate

Machine Mixing Produces a smoother, more plastic putty, easier to use and with better coverage. Use approx. 23 L (6 gal.) water to each 23 kg (50-lb.) bag of RED TOP Finish Lime. **Hand Mixing**—Slowly sift RED TOP Lime into water in soaking box. Allow material to take up water for about 20 or 30 min. and then hoe briskly to mix thoroughly.

Let mix soak for min. of 16 hrs. to develop full workability and plasticity. For use, screen through 8-mesh (2.5 mm (0.1") opening) hardware cloth and mix with gauging plaster that meets job requirements. Application follows directions for Gauging Plasters.

Prepared Finishes

CGC Offers Several Prepared Finishes IMPERIAL Brand Finish Plaster, and DIAMOND Brand Interior Finish Plaster to shorten construction time and provide hard, abrasion-resistant surfaces. The type of plaster finish used will depend to a large degree on the level of abuse resistance required from the final assembly (See Appendix for Categories of Abuse Resistance).

Allow basecoat plaster to set but not completely dry before application of prepared finishes. If basecoat plaster has dried, complete misting of the surface is required before applying finish.

Mixing Prepared finishes require the addition of water on the job. Water should be clean, fresh, suitable for human consumption, and free from mineral and organic substances that affect the plaster set. Water used for rinsing or cleaning is not suitable for mixing because it accelerates the plaster set.

Mechanical mixing is mandatory for prepared finishes. Mix no more material than can be applied before set begins. Since prepared finishes set more rapidly than most conventional plasters, always consult bag directions for specific setting times. Prepared finishes will produce mortar of maximum performance and workability when the correct equipment is used and mixing directions carefully followed. Proper mixing is one of the most important factors in producing mortar of maximum workability.

Use a cage-type mixer paddle driven by a heavy-duty 13 mm (1/2") electric drill with a no-load rating of 900-1,000 rpm. Do not use a propeller-type paddle or conventional mortar mixer. (For details on the cage-type mixing paddle and available electric drills, see pages 400-401 or PM19, *Mixing Equipment for Veneer Plasters*.)

Mix plaster in 60 or 115 L smooth-sided container strong enough to withstand impacts that could cause gouging. Do not use brittle containers for mixing.

Correct Mixing Rapid and with high shear action—is essential for proper dispersion of plaster ingredients. Slow mixing can reduce plasticity of the material. Overmixing can shorten working time. Operated at correct speed, the cage-type design paddle mixes thoroughly without introducing excess air into the mix.

IMPERIAL Brand Finish Plaster Scratch in a tight, thin coat of IMPERIAL Brand Finish Plaster over the entire area, immediately doubling back with plaster from the same batch to full thickness of 1.6 to 2.4 mm (1/16" to 3/32"). Fill all voids and imperfections. Final trowel after surface has become firm, holding trowel flat and using water sparingly. Do not overtrowel.

Best results for IMPERIAL Brand Finish Plaster are obtained by planning the plastering to permit continuous application from angle to angle. Where joining is unavoidable, use trowel to terminate unset plaster in sharp, clean edge—do not feather out. Bring adjacent plaster up to terminated edge and leave level. Do not overlap. During finish troweling, use excess material to fill and bridge joining.

DIAMOND Brand Interior Finish Plaster Scratch in a tight, thin coat of DIAMOND Brand Interior Finish Plaster over the entire area, immediately doubling back with plaster from the same batch to full thickness of 1.6 to 2.4 mm (1/16" to 3/32"). Fill all voids and imperfections. Final trowel after surface has become firm, holding trowel flat and using water sparingly. Do not overtrowel.

A variety of textures ranging from sand float to Spanish can be achieved with DIAMOND Brand Interior Finish Plaster when job-aggregated with silica sand. (When DIAMOND Brand Interior Finish Plaster is job-aggregated, one tablespoon of cream of tartar or 1.25 mL (.25 teaspoon) of CGC Retarder for Lime Containing Plaster Products should be added for each bag of finish to retard plaster and allow sufficient working time.)

Application is the same as for neat DIAMOND Brand Interior Finish Plaster except that once the surface has been leveled and sufficient take-up has occurred, begin floating material from the same batch with trowel, float, sponge or by other accepted local techniques.

DIAMOND Brand Interior Finish Plaster also may be textured by skip troweling. When applying in this manner, eliminate final troweling. When surface has become sufficiently firm, texture with material from the same batch prior to set.

Special Additives

CGC offers a number of special additives to improve plaster bond or enhance its abuse resistance or performance characteristics. Among those additives are USG Plaster Bonder and USG ACRI-ADD 100% Acrylic Add-Mix Fortifier.

USG Plaster Bonder is a vinyl acetate homopolymer emulsion that helps bond new plaster to virtually any structurally sound interior surface. Structurally sound surfaces should be clean and free from loose material, dust, dirt, oil, grease, wax, loose paint, mildew, rust or efflorescence. Glossy painted surfaces should be dulled by an abrasive and adjacent surfaces should be protected using masking tape, soap powder emulsion or other commercially available protective product. Bonder should be hand stirred and applied as is with brush, roller or spray.

USG ACRI-ADD 100% Acrylic Add-Mix Fortifier is an additive that improves bond strength, water resistance, shrink/crack resistance and durability of gypsum or cement-based plaster products. Mix USG ACRI-ADD with water at a ratio of 1:3, 1:2 or 1:1 and substitute for water in mix of plaster material depending on end use. May be used as an additive for plaster patching, setting-type joint compound patching, mortar and grout fortification, and cement patching. Especially useful in areas subject to vibration and heavy traffic.

Replastering Old Plaster Surfaces

In plastering over old plaster surfaces, certain precautions should be exercised to ensure a satisfactory result. Often, the old surface is lime mortar plaster on wood lath, is badly cracked, and usually has been covered with canvas and/or multiple coats of paint.

The following suggestions for lathing and plastering over such old surfaces are listed in order of preference for best results:

1. If the old plaster and lath are removed, GRAND PRIX Plaster Base may be applied to the framing and plastered in the same manner as for new work, following all applicable specifications.
2. If the old lath and plaster are left in place, the following methods may be used, after determining that the framing is of adequate size to carry the additional weight of a new plaster finish (average 39 kg/m² (8 lb./ft.²)).
 - (a) Apply 19 x 64 mm (1" x 3") furring strips 400 mm (16") o.c. with 9-ga. nails, 83 mm (3-1/4") long or of sufficient length to achieve 45 mm (1-3/4") min. penetration into framing. Then apply GRAND PRIX Plaster Base and plaster in same manner as specified for new work.

- (b) Apply 1.8 kg/m² (3.4-lb.) self-furring DIAMOND mesh metal lath over old surface by nailing through into framing, using 50 mm (2") 11-ga. 11 mm (7/16")-head barbed-shank galvanized roofing nails, 150 mm (6") o.c. Wire tie side and end laps. Apply plaster in three coats. RED TOP Gypsum Plaster can be used with max. 56 L (0.056 m³) (2 cu. ft.) of sand for scratch coat, max. 84 L (0.084 m³) (3 cu. ft.) of sand for brown coat, or with 70 L (0.07 m³) (2-1/2 cu. ft.) of sand for scratch and brown coats. Lightweight aggregate should not be used in replastering when using metal lath.
3. If the old plaster is removed and wood lath left in place, all loose laths should be renailed and the lath repeatedly sprayed with water over a period of several hours in order to wet thoroughly. Then replaster as specified in 2(b). Note: If wood lath is not thoroughly nailed and wetted, cracking of the plaster may occur. Finish coat may be smooth trowel or sand float, as desired, mixed and applied per applicable specifications.

Door Frames

Hollow metal door frames are shop-fabricated of 1.5 mm (16-ga.) and 1.2 mm (18-ga.) primed steel. Floor anchor plates of 1.5 mm (16-ga.) steel, with two anchor holes to prevent rotation, are welded to trim flanges to dampen door impact vibrations. Jamb anchor clips should be formed of 1.2 mm (18-ga.) steel, welded in the jamb and head.

Frames used with various plaster systems must be rigidly secured to the floor and partition construction to prevent twisting or other movement. If door frames are free to twist upon impact, cracking of plaster will result and eventually the frames will loosen. In addition to the framing specifications described, door closers are recommended on all oversize doors where the weight, including hardware, is over 23 kg (50 lb.)

Grouting of Door Frames Always recommended, and required where heavy or oversize doors are used. As a grout, use a 100:2 RED TOP Gypsum Plaster-sand mix, adding enough water so that the material is stiff but workable.

Under no condition should the lath and plaster terminate against the trim of the door frame. Grouting of exterior door frames with gypsum plasters is not recommended.

Control Joints Also help prevent cracking of plaster at door frames. To break continuity of framing for control joint location, install door frame and place friction-fit cripple studs next to frame uprights. Allow 6 mm (1/4") clearance for Zinc Control Joints Nos. 50, 75 and 100. Continue with plaster base application using required control joint at break in framing above door frame.

Door Frames with Studless Metal Lath Partitions Follow general directions for fabricating door frames. Use four jamb anchors on each jamb and wire tie to support frame. Use temporary bracing to hold frame until plaster has set.

Door frame

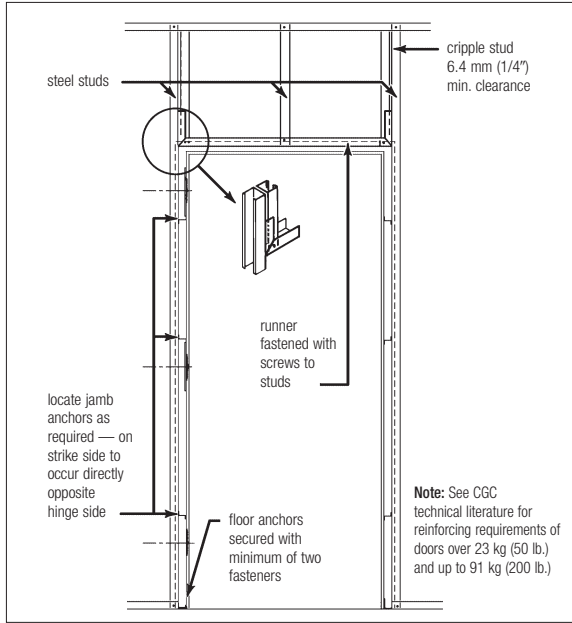

Elevation cross section

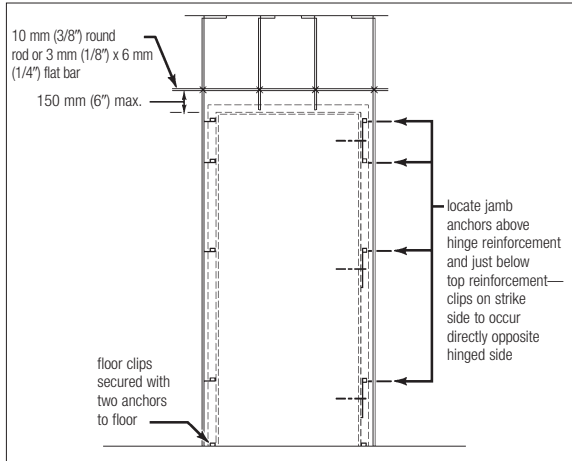

Jamb details

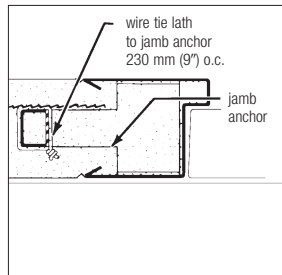
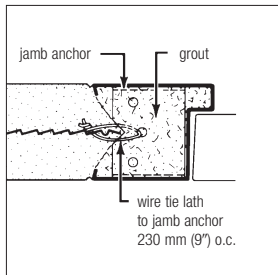

Door Frames with Stud-Metal Lath Solid Partitions Fabricate as previously described with four jamb anchors welded to trim returns. Anchor frame to floor with power-driven fasteners.

Insert studs into steel door frame. Nest studs in notches of jamb anchor clips and wire tie. Install a 10 mm (3/8") round rod or a 3 x 32 mm (1/8" x 1-1/4") flat bar across head of door, extending to engage first stud beyond frame. Wire tie bar at each channel intersection.

Grout steel door frames solid with mortar when scratch coat of plaster is applied.

Caulking Procedures

Where a plaster partition is used as a sound barrier, a quality acoustical sealant should be used to seal all cutouts and all intersections with the adjoining structure. Caulking at runners and around the partition perimeter between gypsum lath and/or plaster and the structure is required to achieve sound transmission class (STC) values on the job that approximate those determined by test. Caulking has proven to be the least expensive way to obtain better sound control.

The surfaces to be caulked should be clean, dry and free of all foreign matter. Using an air-pressure-activated or hand caulking gun, apply SHEETROCK Brand Acoustical Sealant in beads about 10 mm (3/8") round.

Partition Perimeters When gypsum lath is used, leave a space approx. 6 mm (1/4") wide between lath and floor, ceiling and dissimilar walls. Appropriate metal edge-trim or casing beads applied to the lath may be used to create this space. Fill space with acoustical sealant.

When conventional plaster is applied to metal lath, rake out plaster to form a 10 mm (3/8") groove at partition perimeter, and fill groove with acoustical sealant. Finish over groove with base or trim as desired.

Openings Apply a 10 mm (3/8") min. round bead of acoustical sealant around all cutouts such as at electrical boxes, medicine cabinets, heating ducts and cold air returns to seal the opening.

Electrical Fixtures Apply caulking to the backs of electrical boxes and around all boxes to seal the cutout. Avoid cutting holes back to back and adjacent to each other. Electrical boxes having a plaster ring or device cover for use as a stop for caulking are recommended.

*Outlet box caulked
with acoustical sealant*

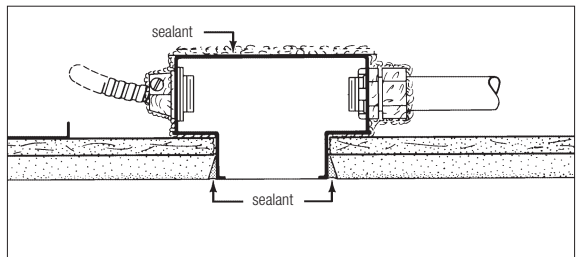

Fixture Attachment

Plaster partitions provide suitable anchorage for most types of fixtures normally found in residential and commercial construction. To ensure satisfactory job performance, evaluation of load requirements of unusual or heavy fixtures and preconstruction planning are needed so that attachments will be within the load-carrying capacity of the construction.

The carrying capacity of a given attachment depends upon the strength of the plaster used. Plaster having a compressive strength of at least 6.2 MPa (900 lb./in.²) was used to develop the data shown in the Fixture Attachment Load Table on page 434 in the Appendix.

The attachment of fixtures to sound-barrier partitions may impair the sound-control characteristics desired. Refrain from attaching fixtures to party walls so as to avoid a direct path for sound flow. Plastered ceilings are not designed to support light fixtures or troffers, air vents or other equipment. Separate supports should be provided.

In wood-frame construction, fixtures are usually attached directly to the framing or to blocking supports attached to the framing. Blocking or supports should be provided for plumbing fixtures, towel racks, grab bars and similar items. Lath and plaster membranes are not designed to support loads imposed by these items without additional support to carry the main part of the load.

To provide information for proper construction, an investigation of loading capacities of various fasteners and fixture attachments used with plaster partitions was conducted at the USG Research & Technology Center. These fasteners and attachments were tested:

Picture Hooks A flattened wire hook attached to the wall with a nail driven diagonally downward. Depending on size, the capacity varies from 2.3 to 23 kg (5 to 50 lbs.) per hook. Suitable for hanging pictures, mirrors and other lightweight fixtures from all plaster partitions.

Fiber and Plastic Expansion Plugs A sheet metal or wood screw driven into a fiber or plastic plug. Annular ribs are provided on outside of plastic plug to assure a positive grip in wall. As screw is inserted, rear end of plug expands and holds assembly in place. Suitable for attaching lightweight fixtures in all partitions (see next page).

Fixture attachments

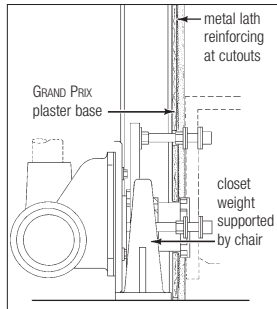
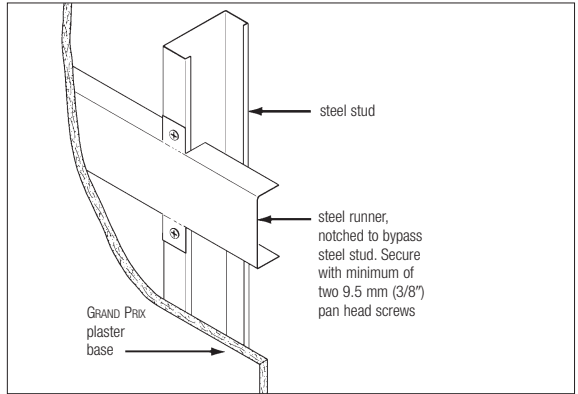
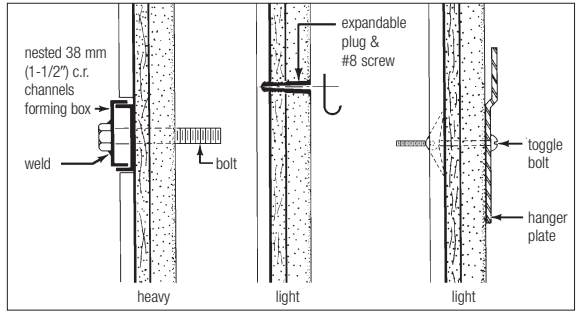

Closet carrier

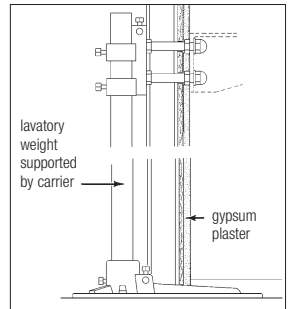

Lavatory carrier

Toggle Bolts Installed in lath and plaster only. Disadvantages of toggle bolt are that when bolt is removed, wing fastener on back will fall down into a hollow wall and a large hole is required to allow wings to pass through wall facings (see above for detail).

Hollow Wall Fasteners Installed in lath and plaster only. One advantage of this type fastener is that threaded section remains in wall when screw is removed. Also, widespread spider support formed by the expanded anchor spreads load against wall material, increasing load capacity.

Bolts and 38 mm (1-1/2") Channels Two 8 mm (5/16") bolts welded to 25 mm (1") channels for use in mounting hanger brackets for heavy fixtures. Two nested channels are securely attached to back of studs in steel-framed partitions (see page 265 for detail).

Angle Brackets Standard 250 x 300 mm (10" x 12") shelving brackets spaced 600 mm (24") o.c. and fastened to wall with three-hole anchorage. Fastened to steel studs with sheet metal screws or to lath and plaster with toggle bolts or hollow wall fasteners.

Continuous Horizontal Bracing Back-up for fixture attachment is provided with notched runner attached to steel studs with two 10 mm (3/8") pan head screws (see page 265 for detail).

Slotted Standards With adjustable shelf brackets, are fastened 600 mm (24") o.c. to steel studs with sheet metal screws or to lath and plaster with toggle bolts or hollow wall fasteners. Normal standard spacing: 600 mm (24") o.c. for 600 mm (24") stud spacing, and 800 mm (32") o.c. for 400 mm (16") stud spacing. Limited to six shelves per partition height.

Separate Supports Individual carriers or chairs placed in the core wall, recommended where heavy bathroom fixtures such as lavatories and water closets without floor supports are required (see page 265 for detail).