



Cartridge Anchoring and Doweling – Hole Preparation and Cartridge Setup

I. Drill hole using a rotary-percussion hammer or similar mechanical equipment to proper diameter and depth. Blow out dust from the bottom of the hole. Brush the hole with a nylon brush. Blow out dust again. The hole should be clean of dust and debris. Always use oil-free compressed air.



II. Insert cartridge into dispenser, making sure it is properly positioned with shoulder of cartridge flush with top bracket of the dispenser.

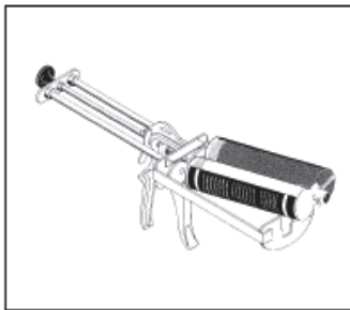

III. Remove plastic cap from the tip of the cartridge. Dispense a small amount of epoxy into a disposable container until you get an even flow of black and white material.

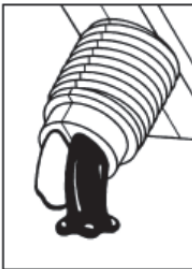

IV. Place nozzle onto cartridge, slide nut over nozzle, and thread nut onto cartridge. No nut is necessary on mixers with built-in nut. Make sure that the nozzle, nut, and cartridge assembly is secure.

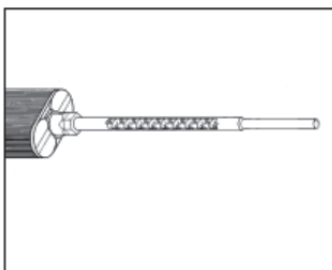

Dispense enough epoxy into a disposable container until the color becomes a consistent gray with no streaks.

Anchoring into Concrete

V. Dispense the material from the bottom of the hole. Fill approximately 1/2 to 5/8 of the hole with adhesive while slowly withdrawing the nozzle. Never fill from top down.

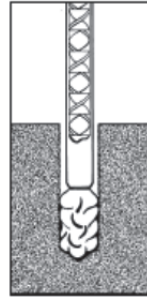

VI. Insert the threaded rod, rebar, or dowel to the bottom of the hole slowly while turning clockwise. The threaded rod, rebar, or dowel must be completely free of dirt, grease, oil, and/or any and all foreign materials that will adversely affect bond. Do not disturb or bolt-up until minimum bolt-up time has been achieved based on temperature. When determining bolt-up time, always use the minimum temperature that the anchor has been exposed to.

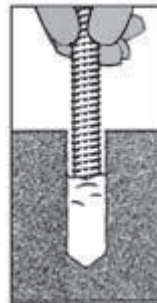

Anchoring into Hollow Block or Unreinforced Masonry

(Please follow steps I – IV and begin by acquiring appropriate size anchoring screen)

V. Always wear chemical resistant protective gloves. Insert the mixing nozzle into the bottom of the screen and completely fill while withdrawing the nozzle. Fill the screen completely full to ensure that the epoxy fills the screen fully when the threaded rod is inserted.



VI. Insert the epoxy-filled screen into the hole.

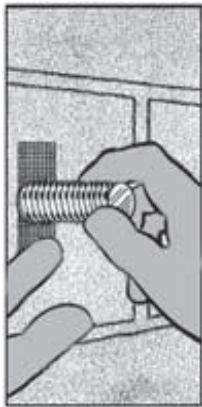
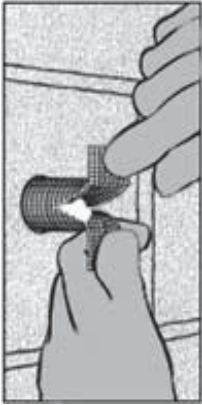

VII. Insert the threaded rod or dowel slowly to the bottom of the screen while turning clockwise. The threaded rod, rebar, or dowel must be completely free of dirt, grease, oil, and/or any and all foreign material that will adversely affect bond.

PRECAUTIONS:

W.R. MEADOWS is not directly or indirectly acting in any manner as the project license design professional, such as, but not limited to, a professional engineer, a licensed architect, and/or a consultant. The suitability and/or functionality of the product are the direct and sole responsibility of the project license design professional, applicator, and/or installer of the product.

W. R. MEADOWS, INC.

P.O. Box 338 • Hampshire, IL 60140-0338
Phone: 847/214-2100 • Fax: 847/683-4544
1-800-342-5976
www.wrmeadows.com

HAMPSHIRE, IL / CARTERSVILLE, GA / YORK, PA
FORT WORTH, TX / BENICIA, CA / POMONA, CA
GOODYEAR, AZ / MILTON, ON / ST. ALBERT, AB

